



NILOS-Rings

Metal seals for bearings

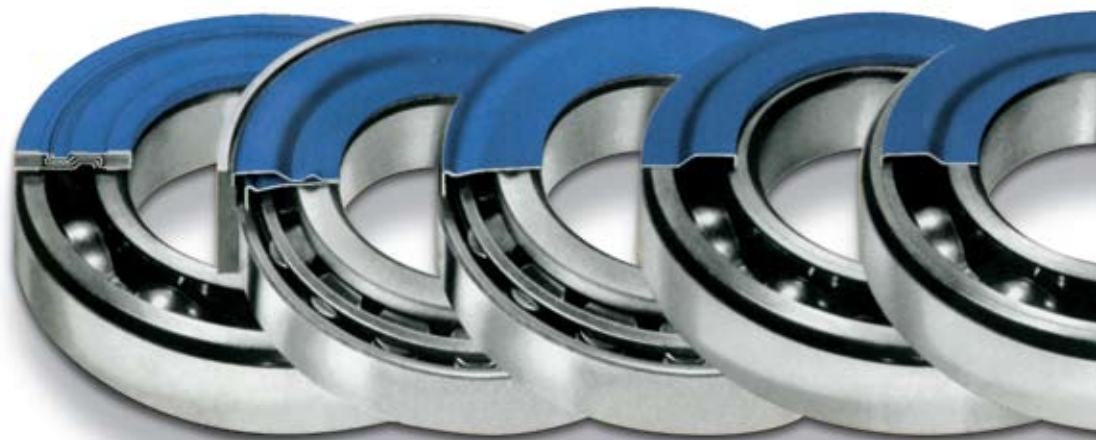

Table of contents

2	NILOS-Rings
10	NILOS-Rings for double row self aligning ball bearings
12	NILOS-Rings for single row deep groove ball bearings
19	NILOS-Rings for double row deep groove ball bearings
20	NILOS-Rings for single row angular contact ball bearings
23	NILOS-Rings for four-point contact ball bearings
24	NILOS-Rings for double row angular contact ball bearings
25	NILOS-Rings for single row magneto bearings
26	NILOS-Rings for single row cylindrical roller bearings
29	NILOS-Rings for single row spherical roller bearings
31	NILOS-Rings for double row self-aligning roller bearings
33	NILOS-Rings for single row taper roller bearings
41	NILOS-Rings for taper roller bearings, inch size

NILOS-Rings

All-metal seals for ball and roller bearings

NILOS-Rings provide practical protection for ball and roller bearings against contamination by dirt and debris, including tough abrasive particles that can cause equipment to malfunction and productivity to be lost.

These all-metal seals are ideal for grease-lubricated anti-friction bearings in industrial environments that routinely generate excessive contaminants, such as those conditions encountered in the mining, paper, agriculture, construction, and automotive industries. Creating an effective space-saving seal for ball and roller bearings even in the harshest operating conditions, NILOS-Rings offer a simple and easily incorporated method to help improve bearing performance and extend service life.

Manufactured for durability and with precision, standard NILOS-Rings are produced from galvanized steel. Stainless and brass rings can be special-ordered as applications require.

The NILOS product line includes specialized ring types designed to seal ball bearings, straight (non-tapered) roller bearings, and tapered roller bearings. Users can further take advantage of NILOS steel-disk seals for bearings that will operate in extreme conditions and spacer rings to promote non-slip clamping. All these products are profiled in this catalog and custom sealing solutions can be developed, based on decades of experience from an industry pioneer and leader.

NILOS-Rings for ball and straight roller bearings

The two standard styles of NILOS-Rings for ball bearings and straight (non-tapered) roller bearings are type AV (for sealing a bearing's outer ring) and type JV (for sealing a bearing's inner ring). Both types are available in a wide range of sizes to fit particular bearing arrangements and can be utilized for circumferential speeds up to 1100 surface feet per minute at the contact diameter.

To accommodate bearings already equipped with integral shields or seals, two variations of the standard styles are offered to provide added protection: type ZAV (for sealing a bearing's outer ring) and type ZJV (for sealing a bearing's inner ring).

Each type is illustrated below in mounted position with selection examples to guide in specification.

NILOS-Rings for tapered roller bearings

Tapered roller bearings present unique design challenges if effective sealing is to be achieved, due to their "offset" cone and cup. For these bearing types three distinct standard styles of NILOS-Rings will serve: type AV (for sealing a tapered roller bearing's outer ring); type JV (for sealing a tapered roller bearing's inner ring); and type AK (featuring a unique two-disk design to enable "double-sealing" of a tapered roller bearing's outer ring). All are available in a wide range of sizes to fit particular tapered roller bearing arrangements.

Each type is illustrated below in mounted position with selection examples to guide in specification.

NILOS-Rings for ball and straight roller bearings

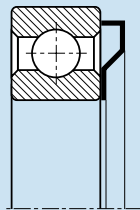

AV-An externally sealing NILOS-Ring for a single-row deep-groove ball bearing would be designated type 6410 AV.

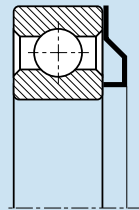

JV-An internally sealing NILOS-Ring for a single-row deep-groove ball bearing would be designated type 6410 JV.

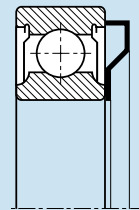

ZAV-An externally sealing NILOS-Ring for a single-row deep-groove ball bearing 6205 with integrated shields/seals would be designated type 6205 ZAV.

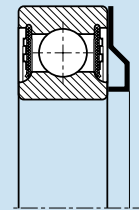

ZJV-An internally sealing NILOS-Ring for single-row deep-groove ball bearing 6205 with integrated shield/seals would be designated type 6205 ZJV.

NILOS-Rings for tapered roller bearings

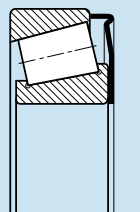

AV-An externally sealing NILOS-Ring for a single-row tapered roller bearing would be designated type 302 07 AV.

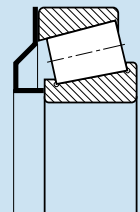

JV-An internally sealing NILOS-Ring for a single-row tapered roller bearing would be designated type 302 07 JV.

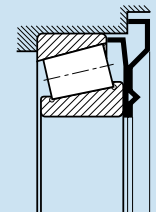

AK-A double externally sealing NILOS-Ring for a single-row tapered roller bearing would be designated type 313 11 AK.

Optimizing ring performance

Lubrication

Prior to mounting for first-time use, the S-shaped sealing grooves of NILOS-Rings should be filled with grease to prevent subsequent damage to the ring's sealing tongue.

In preparing double externally sealing NILOS-Rings (AK), featuring two sealing edges, the space between the edges must likewise be filled with grease before mounting. (The type of grease used to lubricate tapered roller bearings will suffice.) If a bearing will be exposed to excessive amounts of water, the grease chamber would best be filled with a water-repellent sealing grease.

After grease is applied, NILOS-Rings require no further maintenance.

Sealing

As part of the installation process, the sealing edge of a NILOS-Ring is rotated under light pressure against either the inner or outer ring of the bearing. (This is known as run-in or groove-forming.) This rotation creates a shallow groove (or miniature labyrinth) in the hardened bearing ring, which inhibits loss of bearing grease and prevents penetration of debris.

If a design permits, inner-sealing NILOS-Ring types offer particular advantages: Their sealing edges are relatively smaller (for optimum fit) and the position of sealing edges with regard to centrifugal force of lubricant will prove highly favorable.

Concentric location

In order for the miniature labyrinth groove to form during run-in, the sealing edge of the NILOS-Ring must run precisely concentric. With externally sealing rings (AV types), users should fit the bore of the ring closely to the shaft; with internally sealing rings (JV types), users should locate the outside edge of the ring centrally within the bearing casing hole. In either case, the locating diameter should not be proximate to keyways or grooves and the inner and outer edges of a ring's inside recess should not be on (or in) threads, thread runouts, pushed-up sections, or hollow sections.

Space requirement (h_1)

An often-cited benefit of NILOS-Rings is that they require minimal space to install, whose parameters can be calculated quickly and easily.

Referring to dimension tables, installation height (h) represents the overall height without affecting sealing action and $h + 1$ mm represents the space required to mount the ring. Adhering to this formula can eliminate the possibility of ring distortion upon installation.

Slip-proof clamping

Ring design and installation procedure offer certain safeguards to prevent rings from turning in service. The shaft collar of externally sealing types (AV) is designed to fit snugly against a bearing to promote slip-proof clamping. For internally sealing types (JV) users can rely on installation clamping elements.

Application notes

NILOS-Rings can seal self-aligning or spherical (barrel-type) roller bearings only when the bearings are utilized for their high load-carrying capacities and never when misalignment may be a factor.

In applications utilizing cylindrical bearings without rims (or flanges) LSTO-type sealing elements are recommended, since they can accommodate axial shifts to a maximum of 0.3 mm. (LSTO types are profiled in a separate section of this catalog.)

Space requirements

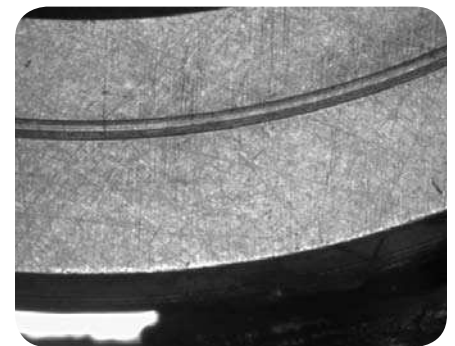
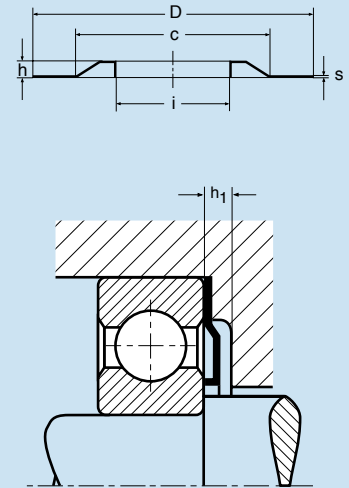

Run-in groove after 24 hours

Accommodating higher speeds

While standard types of NILOS-Rings (AV and JV) are designed to perform effectively in applications with peripheral rotating speeds up to 6 m/s, the potential to serve in applications at even higher speeds can be realized via several methods.

If the groove-forming (or run-in) procedure can be performed below 6 m/s for 24 hours, the sealing edge of a NILOS-Ring

will form fully and the ring can be utilized at speeds higher than 6 m/s without adverse effect.

If this avenue is not practical or possible, higher-speed capabilities can be achieved by installing the ring with reduced or minus preload. Preload will be determined by type of application and speed requirement. (Operating speeds should be provided when ordering.)

In applications operating at peripheral rotating speeds above 15 m/s, users should specify JV types, which are designed especially for these instances.

Speed chart

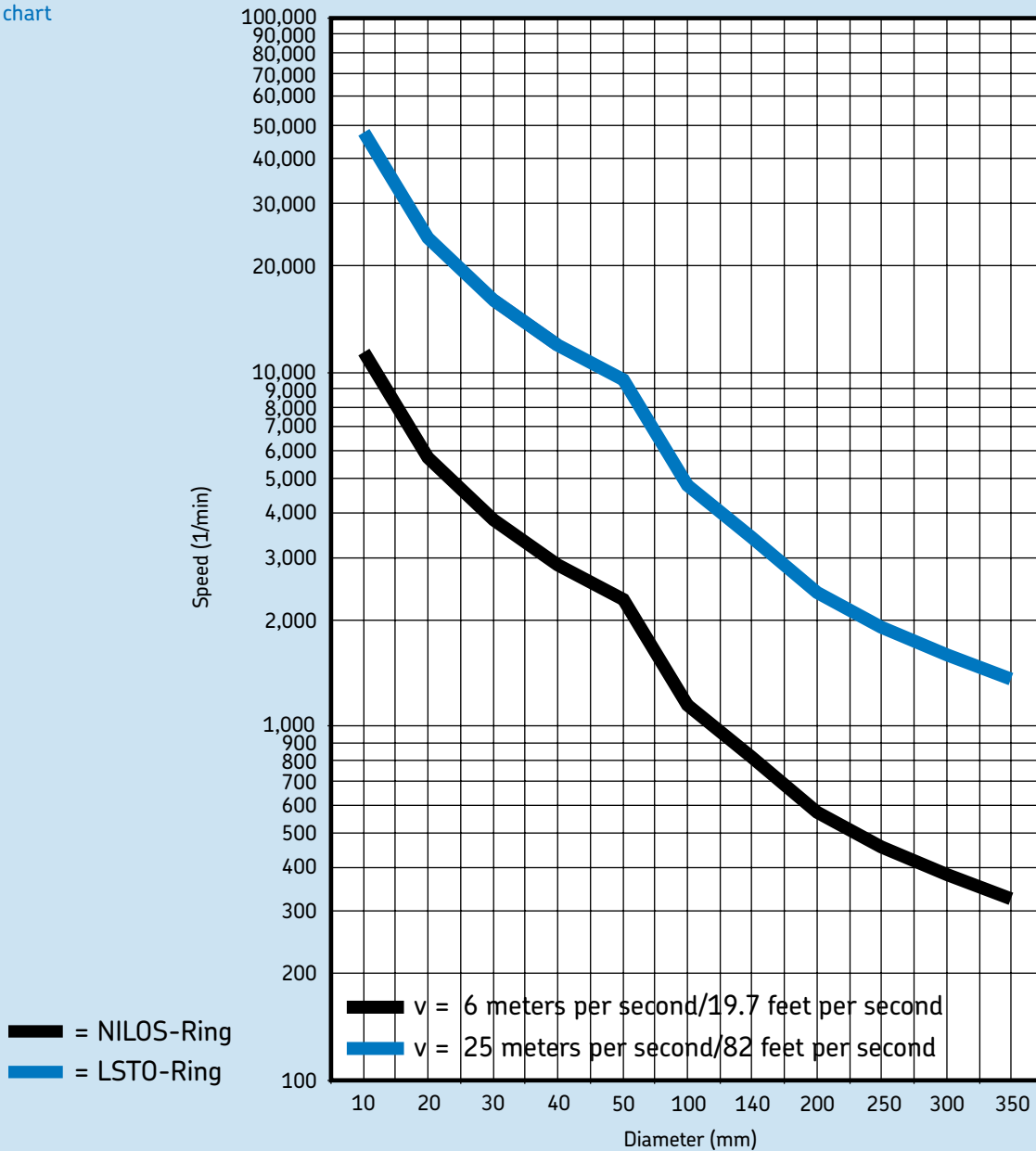

Mounting and installation tips

Deep-groove ball bearings

When installing NILOS-Rings on deep-groove ball bearings, the NILOS-Ring can be damaged as a result of the axial play of the bearing. Therefore, we recommend following the illustrations (at right and below) which show the correct and incorrect way to install the bearing into a NILOS-Ring.

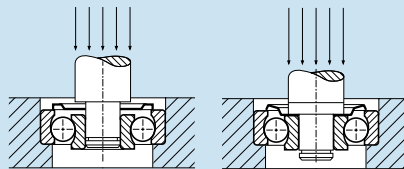

Incorrect method of fitting shaft in ball bearing without the use of a fitting aid.

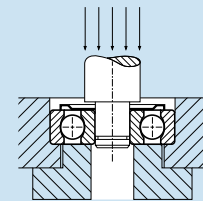

Correct method of fitting shaft in ball bearings.

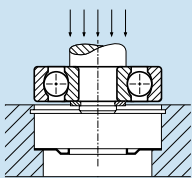

Incorrect method of mounting deep groove ball bearings without the use of a fitting aid. The NILOS-Ring is distorted.

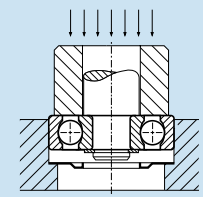
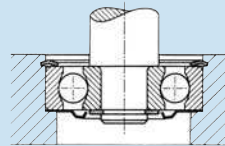
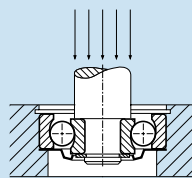

Correct method of fitting deep groove ball bearings.

Tapered roller bearings

Important points to remember when installing AV or AK NILOS-Rings:

The pivot pins of the bearing housing should be installed exactly in the center and parallel both for horizontal and vertical installation. Otherwise, rings can become skewed when installed and damage to sealing edges may result.

In the case of AK rings, the two retaining nubs (or locking dimples) must click into the corresponding cutouts in the shock

ring or pivot pins. This will prevent the ring (with its two sealing edges) from turning in service.

These locking dimples are placed at 180 degrees on a pitch circle diameter (w in the dimension tables). The dimples have a base diameter of 4 mm and height of approximately 2.5 mm. To locate them in the abutment shoulder or spacing washer against which the ring is installed, two small holes can be bored or grooves should be made

to fit a small screwed-in striking pin. This pin will then be in position to serve as a positive stop at one of the two dimples in case of slipping.

The illustrations (below) represent proper installation of AK rings.

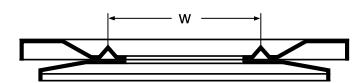

Showing "w" locking dimples

Installation of AK rings

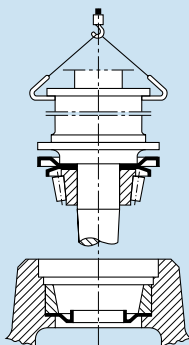

Correct method of fitting a taper roller bearing with a NILOS-Ring AK.

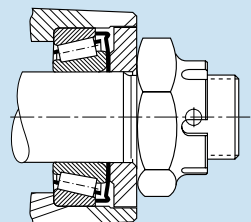

Tighten firmly so that sealing edges of NILOS-Ring will be put under slight tension.

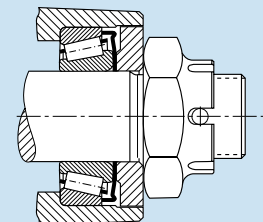

Release about 1/6 turn. By that the tension of the sealing edge of the NILOS-Ring will be reduced to the proper amount.

As a general guide, these drawings reflect “correct” vs. “incorrect” installation scenarios.

Correct

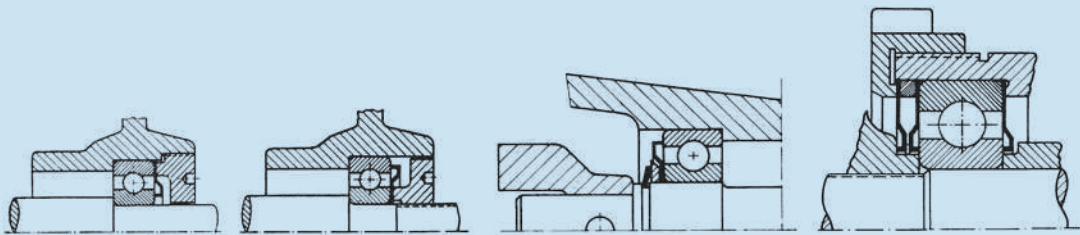

Incorrect

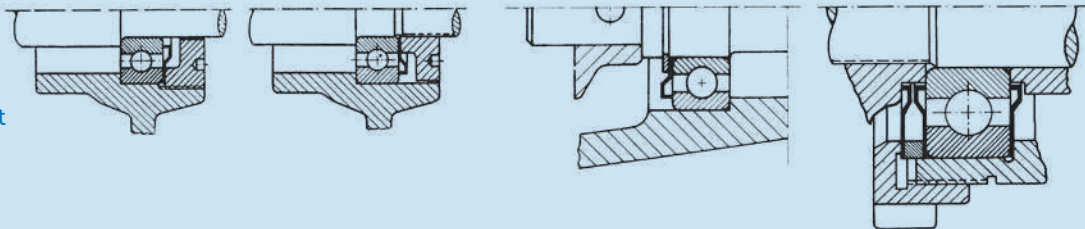

Every sealing element must run absolutely concentric. The NILOS-Ring must therefore, according to its application, either be centered on the bearing housing or on the shaft.

Particular attention must be given to the design as far as keyways or grooves are concerned.

Standard NILOS-Ring ball bearing seal using a NILOS Spacer and a locking ring.

Ball bearing sealed with standard NILOS-Rings (one seal on ball bearing and one on bearing housing).

Correct

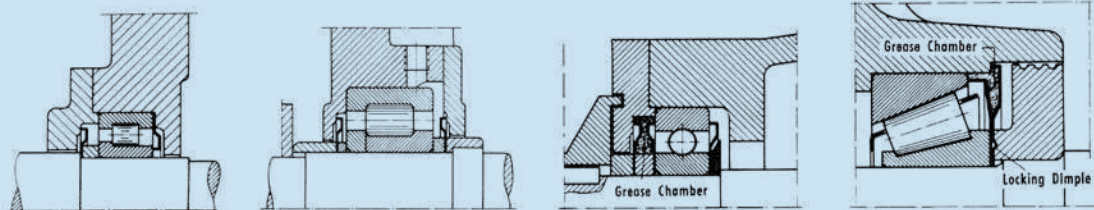

Incorrect

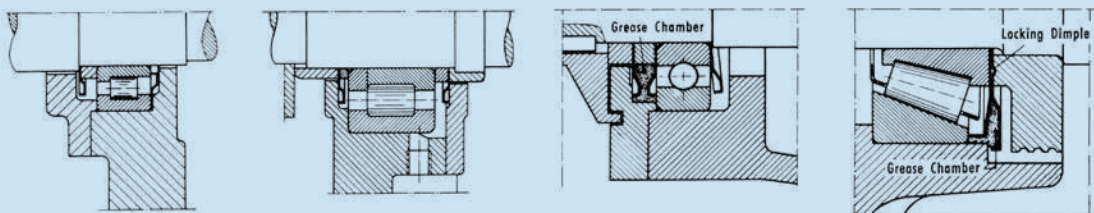

NILOS-Rings in a roller bearing. Cover too deep, bearing housing does not allow enough space for the seal width.

NILOS-Rings in a roller bearing with regreasing availability. Both of them have contact with their clamping surface.

Ball bearing sealing with grease chamber formed by standard NILOS-Rings. The clamping of NILOS-Ring is insufficient the shaft shoulder being too small in diameter.

Taper roller bearing sealed with NILOS AK Ring in a wheel-boss. The counterbore is too deep and too large in diameter.

LSTO Steel-Disk Seals for Extreme Conditions

NILOS-Ring LSTO Labyrinth seal will act as superior seals in applications where grease-lubricated bearings will likely be exposed to extreme levels of contamination. These specialized seals are provided ready-to-install.

Unlike other types, NILOS-Rings LSTO are non-contact, grease-filled labyrinth sealing elements. They consist of laminated steel-seal disks and steel cores, whose seal resists axial pressure and will not slip when clamped in the axial direction of the

inner and outer periphery of a roller-bearing ring. (The table below cites shoulder dimensions W_A and W_J).

The LSTO Ring is illustrated to the right in a mounted position with a selection example to guide in specification.

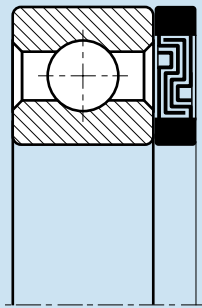

A NILOS-Ring LSTO steel-disk seal ready for installation for a roller bearing with 30 mm internal diameter and 55 mm external diameter would be designated 30 x 55 LSTO.

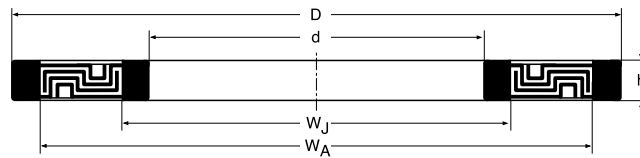

d (tolerance M8)	D (tolerance k7)	NILOS-Ring part number	h+0.2	W_A	W_J	Fitting bearing sizes
10	30	10 x 30 LSTO	4.0	25	15	
12	28	12 x 28 LSTO	4.0	25	15	
15	35	15 x 35 LSTO	4.0	30	20	
17	35	17 x 35 LSTO	4.0	31	21	
17	40	17 x 40 LSTO	4.0	34	23	
20	42	20 x 42 LSTO	4.0	38	24	
20	47	20 x 47 LSTO	4.0	41	26	
20	52	20 x 52 LSTO	4.0	45	27	
25	47	25 x 47 LSTO	4.0	43	29	
25	52	25 x 52 LSTO	4.0	46	31	
25	62	25 x 62 LSTO	4.0	54	33	
30	55	30 x 55 LSTO	4.0	50	35	
30	62	30 x 62 LSTO	4.0	56	36	
30	72	30 x 72 LSTO	4.0	65	37	
35	62	35 x 62 LSTO	4.0	57	40	
35	72	35 x 72 LSTO	4.0	65	42	
35	80	35 x 80 LSTO	4.0	71	44	
40	68	40 x 68 LSTO	4.0	63	45	
40	80	40 x 80 LSTO	4.0	73	47	
40	90	40 x 90 LSTO	4.0	81	49	
45	75	45 x 75 LSTO	4.0	70	50	
45	85	45 x 85 LSTO	4.0	78	52	
45	100	45 x 100 LSTO	4.0	91	54	
50	90	50 x 90 LSTO	4.0	83	57	
50	110	50 x 110 LSTO	4.0	99	61	
55	100	55 x 100 LSTO	4.0	91	64	
60	110	60 x 110 LSTO	4.0	101	69	
70	125	70 x 125 LSTO	4.0	116	79	
75	130	75 x 130 LSTO	4.0	121	84	
80	140	80 x 140 LSTO	4.0	129	91	

NILOS-Ring LSTO fit all bearing sizes having corresponding inner and outer diameter dimensions.

LSTL Steel-Disks for Submerged Applications

NILOS-Ring LSTL Labyrinth seal will act as superior seals in applications where grease-lubricated bearings will likely be exposed to extreme levels of water during washdown or in submergible environments. These specialized seals are provided ready-to-install.

Like NILOS-Rings LSTO, NILOS-Rings LSTL are non-contact, grease-filled labyrinth sealing elements. They consist of 304 series stainless steel-seal disks and stainless steel cores, whose seal resists axial pressure and will not slip when clamped in the axial direction of the inner and outer periphery of a roller-bearing ring.

To protect against wet conditions, LSTL cores are furnished with a viton seal. Due to the viton seal, LSTL seals have a maximum speed rating of 3 m/s. If speeds exceed LSTL capabilities, please contact SKF Engineering.

The LSTL mounting instructions are identical to the LSTO mounting instructions shown on page 7.

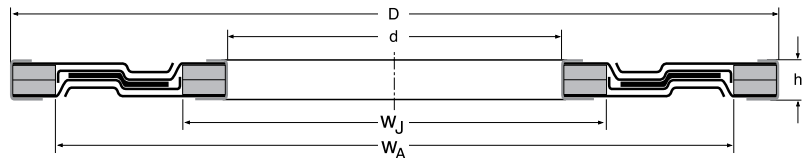

d (tolerance M8)	D (tolerance k7)	NILOS-Ring part number	h+0.2	W _A	W _J
15	35	15 x 35 LST-L	4.0	30	20
17	35	17 x 35 LST-L	4.0	31	21
17	40	17 x 40 LST-L	4.0	34	23
20	42	20 x 42 LST-L	4.0	38	24
20	47	20 x 47 LST-L	4.0	41	26
20	52	20 x 52 LST-L	4.0	45	27
25	47	25 x 47 LST-L	4.0	43	29
25	52	25 x 52 LST-L	4.0	46	31
30	55	30 x 55 LST-L	4.0	50	35
30	62	30 x 62 LST-L	4.0	56	36
35	62	35 x 62 LST-L	4.0	57	40
35	72	35 x 72 LST-L	4.0	65	42
40	68	40 x 68 LST-L	4.0	63	45
40	80	40 x 80 LST-L	4.0	73	47
45	75	45 x 75 LST-L	4.0	70	50
45	85	45 x 85 LST-L	4.0	78	52
50	90	50 x 90 LST-L	4.0	83	57
60	110	60 x 110 LST-L	4.0	101	69
70	125	70 x 125 LST-L	4.0	116	79
75	130	70 x 130 LST-L	4.0	121	84

The NILOS-Ring abbreviation 30x55 LST-L indicates a steel disk seal that is ready for installation for a rolling bearing with an internal diameter of 30mm and an external diameter of 55mm. It is sufficient to give the abbreviated designation when ordering the relevant NILOS-Ring.

NILOS Spacer Rings

NILOS Spacer Rings are ideal when using a normal locking ring and can promote easier ring mounting. Two styles are offered: type A (for use with externally sealing AV rings) and type J (for use with internally sealing JV rings.) Optimum non-slip clamping can be achieved by matching spacer rings with Seeger® L-rings, which will compensate further for axial play.

A unique design advantage inherent in NILOS Spacer Rings: Their width serves to prevent jamming the NILOS-Ring into the groove of the locking ring.

Proper selection of a spacer ring will depend on the diameter of the shaft or housing (referenced in the charts below).

Application Note: NILOS Spacer Rings can be used with all NILOS-Ring types for inner or outer sealing except Series 618, 619 and AK rings.

The material is a form of die-cast zinc. the usable temperature range under heavy loading is 100° C maximum.

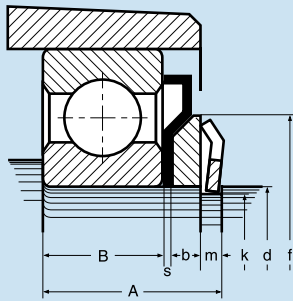

NILOS Spacer Ring type A.
Used with externally sealing NILOS-Ring AV.
NILOS abbreviation A 45 refers to a NILOS Spacer Ring for an externally sealing NILOS-Ring with 45 mm shaft diameter.

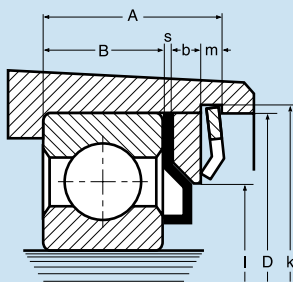

NILOS Spacer Ring type J.
Used with internally sealing NILOS-Ring JV.
NILOS abbreviation J 62 refers to NILOS Spacer Ring for an internally sealing NILOS-Ring with 62 mm diameter housing.

NILOS-Ring A spacer rings

shaft D	NILOS spacer ring part number	f	b
17	A 17	26	2
20	A 20	30	2
25	A 25	37	2
30	A 30	43	2.5
35	A 35	47	2.5
40	A 40	54	2.5
45	A 45	59	2.5
50	A 50	64	2.5
55	A 55	71	3
60	A 60	75	3
65	A 65	83	3.5
70	A 70	88	3.5
75	A 75	94	3.5
80	A 80	100	3.5
85	A 85	105	3.5
90	A 90	111	3.5
95	A 95	115	3.5
100	A 100	122	3.5

NILOS-Ring J spacer rings

shaft D	NILOS spacer ring part number	l	b
22	J 22	14	2
26	J 26	17	2.5
28	J 28	19	2.5
30	J 30	20	2.5
32	J 32	22	3
35	J 35	24	2.5
40	J 40	27	2.5
42	J 42	29	3
47	J 47	34	3
52	J 52	37	3
55	J 55	41	3
62	J 62	48	3
68	J 68	50	3.5
72	J 72	50	3.5
75	J 75	57	3.5
80	J 80	60	3.5
85	J 85	60	3.5
90	J 90	68	3.5
95	J 95	73	3.5
100	J 100	77	4

NILOS-Rings for double row self aligning ball bearings

Series 12
Series 13

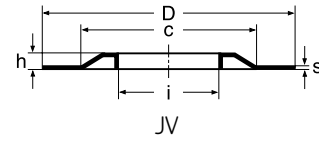
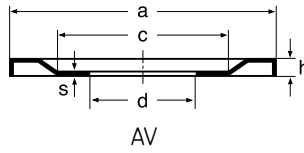
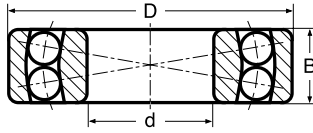

Bearing	d	D	B
1200	10	30	9
1201	12	32	10
1202	15	35	11
1203	17	40	12
1204	20	47	14
1205	25	52	15
1206	30	62	16
1207	35	72	17
1208	40	80	18
1209	45	85	19
1210	50	90	20
1211	55	100	21
1212	60	110	22
1213	65	120	23
1214	70	125	24
1215	75	130	25
1216	80	140	26
1217	85	150	28
1218	90	160	30
1219	95	170	32
1220	100	180	34
1221	105	190	36
1222	110	200	38

NILOS-Ring	a	c	d	h	s
1200 AV	27.5	18	10	1.8	0.3
1201 AV	30	20	12	1.8	0.3
1202 AV	32.8	22	15	2	0.3
1203 AV	36.8	26	17	2	0.3
1204 AV	41.9	29	20	2	0.3
1205 AV	47.8	35	25	2.5	0.3
1206 AV	56.2	44	30	2.5	0.3
1207 AV	64.8	48	35	2.5	0.3
1208 AV	74.6	54	40	3	0.3
1209 AV	77.8	61	45	3	0.3
1210 AV	82.8	67	50	3	0.3
1211 AV	93.5	76	55	3	0.3
1212 AV	100.8	85	60	3	0.3
1213 AV	110.5	90	65	3	0.3
1214 AV	115.8	95	70	3.5	0.3
1215 AV	122	100	75	3.5	0.5
1216 AV	129	106	80	3.5	0.5
1217 AV	138.5	115	85	3.5	0.5
1218 AV	148	124	90	3.5	0.5
1219 AV	157.5	130	95	3.5	0.5
1220 AV	167	135	100	4	0.5
1221 AV	174	140	105	4	0.5
1222 AV	184	150	110	4	0.5

NILOS-Ring	i	c	D	h	s
1200 JV	14.4	24	30	1.8	0.3
1201 JV	16.4	26	32	1.8	0.3
1202 JV	17.3	27	35	2	0.3
1203 JV	21.5	31	40	2	0.3
1204 JV	25.7	37	47	2	0.3
1205 JV	28	42	52	2.5	0.3
1206 JV	36.3	47	62	2.5	0.3
1207 JV	43	56	72	2.5	0.3
1208 JV	48	62	80	3	0.3
1209 JV	53	68	85	3	0.3
1210 JV	57.5	73	90	3	0.3
1211 JV	64.5	80	100	3	0.3
1212 JV	70	85	110	3	0.3
1213 JV	74.5	95	120	3	0.3
1214 JV	79.5	102	125	3.5	0.3
1215 JV	85	105	130	3.5	0.5
1216 JV	92	112	140	3.5	0.5
1217 JV	98	125	150	3.5	0.5
1218 JV	103	125	160	3.5	0.5
1219 JV	110	137	170	3.5	0.5
1220 JV	115	145	180	4	0.5
1221 JV	119.5	158	190	4	0.5
1222 JV	125.5	165	200	4	0.5

1300	10	35	11
1301	12	37	12
1302	15	42	13
1303	17	47	14
1304	20	52	15
1305	25	62	17
1306	30	72	19
1307	35	80	21
1308	40	90	23
1309	45	100	25
1310	50	110	27
1311	55	120	29
1312	60	130	31
1313	65	140	33
1314	70	150	35
1315	75	160	37
1316	80	170	39
1317	85	180	41
1318	90	190	43
1319	95	200	45

1300 AV	30.6	20	10	2	
1301 AV	32.7	23	12	2	
1302 AV	38	28	15	2	0.3
1303 AV	41.2	29	17	2	0.3
1304 AV	46.5	37	20	2	0.3
1305 AV	54.8	40	25	2.5	0.3
1306 AV	64.8	48	30	2.5	0.3
1307 AV	72.7	57	35	3	0.3
1308 AV	82	60	40	3	0.3
1309 AV	90.8	75	45	3	0.3
1310 AV	98.8	80	50	3	0.3
1311 AV	110.5	90	55	3	0.3
1312 AV	120.5	100	60	3.5	0.5
1313 AV	127.5	100	65	3.5	0.5
1314 AV	137	110	70	3.5	0.5
1315 AV	147	110	75	3.5	0.5
1316 AV	157.5	130	80	3.5	0.5
1317 AV	164	135	85	4	0.5
1318 AV	174	140	90	4	0.5
1319 AV	184	150	95	4	0.5

1300 JV	15.5	27	35	2	0.3
1301 JV	17.5	29	37	2	0.3
1302 JV	20.8	33	42	2	0.3
1303 JV	23	36	47	2	0.3
1304 JV	27.2	40	52	2	0.3
1305 JV	32.2	47	62	2.5	0.3
1306 JV	37.2	56	72	2.5	0.3
1307 JV	45	65	80	2.5	0.3
1308 JV	51	70	90	3	0.3
1309 JV	56	80	100	3	0.3
1310 JV	62	86	110	3	0.3
1311 JV	67	93	120	3	0.3
1312 JV	73	102	130	3	0.5
1313 JV	77.5	110	140	3.5	0.5
1314 JV	82.6	120	150	3.5	0.5
1315 JV	87.2	125	160	3.5	0.5
1316 JV	95	138	170	3.5	0.5
1317 JV	100	140	180	4	0.5
1318 JV	106	150	190	4	0.5
1319 JV	115	160	200	4	0.5

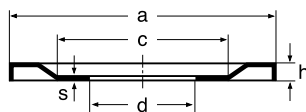
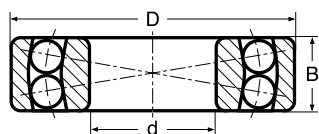

AV

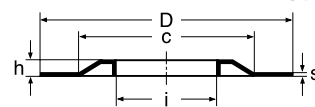

JV

Bearing	d	D	B
2200	10	30	14
2201	12	32	14
2202	15	35	14
2203	17	40	16
2204	20	47	18
2205	25	52	18
2206	30	62	20
2207	35	72	23
2208	40	80	23
2209	45	85	23
2210	50	90	23
2211	55	100	25
2212	60	110	28
2213	65	120	31
2214	70	125	31
2215	75	130	31
2216	80	140	33
2217	85	150	36
2218	90	160	40
2219	95	170	43

NILOS-Ring	a	c	d	h	s
2200 AV	27.5	18	10	1.8	0.3
2201 AV	30	20	12	1.8	0.3
2202 AV	32.8	22	15	2	0.3
2203 AV	36.8	26	17	2	0.3
2204 AV	41.9	29	20	2	0.3
2205 AV	47.8	35	25	2.5	0.3
2206 AV	56.2	44	30	2.5	0.3
2207 AV	64.8	48	35	2.5	0.3
2208 AV	74.6	54	40	3	0.3
2209 AV	77.8	61	45	3	0.3
2210 AV	82.8	67	50	3	0.3
2211 AV	93.5	76	55	3	0.3
2212 AV	100.8	85	60	3	0.3
2213 AV	110.5	90	65	3	0.3
2214 AV	115.8	95	70	3.5	0.3
2215 AV	122	100	75	3.5	0.5
2216 AV	129	106	80	3.5	0.5
2217 AV	138.5	115	85	3.5	0.5
2218 AV	148	124	90	3.5	0.5
2219 AV	157.5	130	95	3.5	0.5

NILOS-Ring	i	c	D	h	s
2200 JV	13.5	24	30	1.8	0.3
2201 JV	15.5	25	32	1.8	0.3
2202 JV	18.6	27	35	2	0.3
2203 JV	21.5	31	40	2	0.3
2204 JV	25.7	37	47	2	0.3
2205 JV	31.5	42	52	2.5	0.3
2206 JV	36.3	47	62	2.5	0.3
2207 JV	43	56	72	2.5	0.3
2208 JV	48	62	80	3	0.3
2209 JV	53	68	85	3	0.3
2210 JV	57.5	73	90	3	0.3
2211 JV	64.5	80	100	3	0.3
2212 JV	70	85	110	3	0.3
2213 JV	74.5	95	120	3	0.3
2214 JV	79.5	102	125	3.5	0.3
2215 JV	85	105	130	3.5	0.5
2216 JV	92	112	140	3.5	0.5
2217 JV	98	125	150	3.5	0.5
2218 JV	103	125	160	3.5	0.5
2219 JV	110	137	170	3.5	0.5

2302	15	42	17
2303	17	47	19
2304	20	52	21
2305	25	62	24
2306	30	72	27
2307	35	80	31
2308	40	90	33
2309	45	100	36
2310	50	110	40
2311	55	120	43
2312	60	130	46
2313	65	140	48
2314	70	150	51
2315	75	160	55
2316	80	170	58
2317	85	180	60
2318	90	190	64
2319	95	200	67

2302 AV	36.5	26	15	2	0.3
2303 AV	41.2	29	17	2	0.3
2304 AV	46.5	37	20	2	0.3
2305 AV	54.8	40	25	2.5	0.3
2306 AV	64.8	18	30	2.5	0.3
2307 AV	70.7	54	35	2.5	0.3
2308 AV	80.5	60	40	3	0.3
2309 AV	90.8	75	45	3	0.3
2310 AV	98.8	80	50	3	0.3
2311 AV	108	89	55	3	0.3
2312 AV	117.5	95	60	3	0.3
2313 AV	127.5	100	65	3.5	0.5
2314 AV	137	110	70	3.5	0.5
2315 AV	147	110	75	3.5	0.5
2316 AV	157.5	130	80	3.5	0.5
2317 AV	164	135	85	4	0.5
2318 AV	174	140	90	4	0.5
2319 AV	184	150	95	4	0.5

2302 JV	20.8	33	42	2	0.3
2303 JV	23	36	47	2	0.3
2304 JV	25.7	40	52	2.5	0.3
2305 JV	32.2	47	62	2.5	0.3
2306 JV	37.2	56	72	2.5	0.3
2307 JV	41.9	60	80	3	0.3
2308 JV	51	70	90	3	0.3
2309 JV	56	80	100	3	0.3
2310 JV	62	86	110	3	0.3
2311 JV	67	93	120	3	0.3
2312 JV	73	102	130	3	0.5
2313 JV	77.5	110	140	3.5	0.5
2314 JV	82.6	120	150	3.5	0.5
2315 JV	87.2	125	160	3.5	0.5
2316 JV	95	138	170	3.5	0.5
2317 JV	100	140	180	4	0.5
2318 JV	106	150	190	4	0.5
2319 JV	115	160	200	4	0.5

135	5	19	6
126	6	19	6
127	7	22	7
108	8	22	7
129	9	26	8

135 AV	16.8	11	5	1.5	0.3
126 AV	16.8	11	6	1.5	0.3
127 AV	18.8	12	7	1.8	0.3
108 AV	18.8	12	8	1.8	0.3
129 AV	22	16	9	1.8	0.3

135 JV	8.2	15	19	1.8	0.3
126 JV	8.2	15	19	1.8	0.3
127 JV	10.2	17	22	1.8	0.3
108 JV	10.2	17	22	1.8	0.3
129 JV	13.3	22	26	1.8	0.3

NILOS-Rings for single row deep groove ball bearings

Series 600

Series 600 with shields or seals

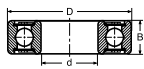
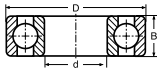

with shields or seals

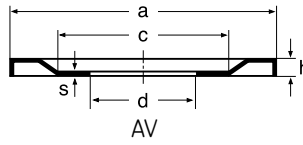

AV

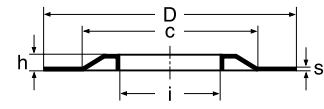

JV

Bearing	d	D	B
623	3	10	4
624	4	13	5
625	5	16	5
626	6	19	6
607	7	19	6
608	8	22	7
609	9	24	7
634	4	16	5
635	5	19	6
627	7	22	7
629	9	26	8

NILoS-Ring	a	c	d	h	s
623 AV	9.2	6	3	1.2	0.3
624 AV	11.8	8	4	1.3	0.3
625 AV	14.8	10	5	1.5	0.3
626 AV	16.8	11	6	1.5	0.3
607 AV	17.8	12	7	1.8	0.3
608 AV	20	13	8	1.8	0.3
609 AV	22	16	9	1.8	0.3
634 AV	14.8	10	4	1.5	0.3
635 AV	16.8	11	5	1.5	0.3
627 AV	20	13	7	1.8	0.3
629 AV	23	17	9	1.8	0.3

NILoS-Ring	i	c	D	h	s
623 JV	4.4	8	10	1.2	0.3
624 JV	5.4	11	13	1.3	0.3
625 JV	6.2	13	16	1.5	0.3
626 JV	7.2	15	19	1.5	0.3
607 JV	8.2	15	19	1.8	0.3
608 JV	10.2	17	22	1.8	0.3
609 JV	11	19	24	1.8	0.3
634 JV	5.4	13	16	1.5	0.3
635 JV	7.2	15	19	1.5	0.3
627 JV	10.2	17	22	1.8	0.3
629 JV	12.3	22	26	1.8	0.3

with shields or seals

623 Z/RS	3	10	4
624 Z/RS	4	13	5
625 Z/RS	5	16	5
626 Z/RS	6	19	6
607 Z/RS	7	19	6
608 Z/RS	8	22	7
609 Z/RS	9	24	7
634 Z/RS	4	16	5
635 Z/RS	5	19	6
627 Z/RS	7	22	7
629 Z/RS	9	26	8

623 ZAV	9.2	6	3	1.2	0.3
624 ZAV	12.2	7	4	1.3	0.3
625 ZAV	14.8	10	5	1.5	0.3
626 ZAV	17.8	12	6	1.8	0.3
607 ZAV	17.8	12	7	1.8	0.3
608 ZAV	20	13	8	1.8	0.3
609 ZAV	22.6	16	9	1.8	0.3
634 ZAV	14.8	10	4	1.5	0.3
635 ZAV	17.8	12	5	1.8	0.3
627 ZAV	20	13	7	1.8	0.3
629 ZAV	23.8	17	9	1.8	0.3

623 ZJV	4	8	10	1.2	0.3
624 ZJV	4.9	11	13	1.3	0.3
625 ZJV	6.2	13	16	1.5	0.3
626 ZJV	7.2	15	19	1.5	0.3
607 ZJV	8	15	19	1.8	0.3
608 ZJV	9.3	17	22	1.8	0.3
609 ZJV	10.4	19	24	1.8	0.3
634 ZJV	5.4	13	16	1.5	0.3
635 ZJV	6.9	15	19	1.8	0.3
627 ZJV	9.3	17	22	1.8	0.3

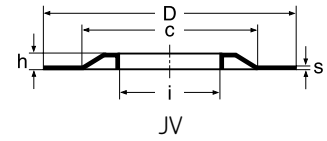
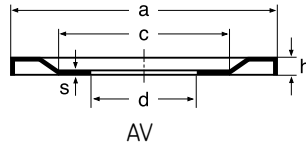
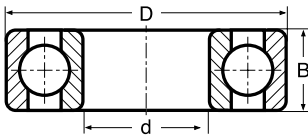

Bearing	d	D	B
61800	10	19	5
61801	12	21	5
61802	15	24	5
61803	17	26	5
61804	20	32	7
61805	25	37	7
61806	30	42	7
61807	35	47	7
61808	40	52	7
61809	45	58	7
61810	50	65	7
61811	55	72	9
61812	60	78	10
61813	65	85	10
61814	70	90	10
61815	75	95	10
61816	80	100	10
61817	85	110	13
61818	90	115	13
61819	95	120	13
61820	100	125	13
61821	105	130	13
61822	110	140	16
61824	120	150	16
61826	130	165	18
61828	140	175	18
61830	150	190	20
61832	160	200	20
61834	170	215	22
61836	180	225	22
61838	190	240	24
61840	200	250	24
61844	220	270	24
61848	240	300	28
61852	260	320	28
61856	280	350	33
61860	300	380	38
61864	320	400	38

NILOS-Ring	a	c	d	h	s
61800 AV	17.4	12.5	10	1.5	0.3
61801 AV	19.4	14.5	12	1.5	0.3
61802 AV	22.4	18	15	1.8	0.3
61803 AV	24.4	20	17	1.8	0.3
61804 AV	29.6	23.5	20	2	0.3
61805 AV	34.6	28.5	25	2	0.3
61806 AV	39.6	34	30	2	0.3
61807 AV	44.9	39	35	2	0.3
61808 AV	50.3	43.5	40	2.5	0.3
61809 AV	55.8	48.5	45	2.5	0.3
61810 AV	61.8	55	50	2.5	0.3
61811 AV	68.8	59.5	55	2.5	0.3
61812 AV	74.2	65.5	60	2.5	0.3
61813 AV	80.5	70.5	65	2.5	0.3
61814 AV	85.7	76	70	2.5	0.3
61815 AV	91.1	80	75	2.5	0.3
61816 AV	95.7	86	80	2.5	0.3
61817 AV	104.8	92.5	85	2.5	0.3
61818 AV	109.8	97.5	90	2.5	0.3
61819 AV	114.6	102	95	3	0.3
61820 AV	119.6	107	100	3	0.3
61821 AV	124.8	112	105	3	0.3
61822 AV	134	120	110	3	0.5
61824 AV	143.4	130	120	3	0.5
61826 AV	157	141	130	3	0.5
61828 AV	168	153	140	3	0.5
61830 AV	180.8	162	150	4	0.5
61832 AV	190.5	172	160	4	0.5
61834 AV	204.3	183	170	4	0.5
61836 AV	215.7	194	180	4	0.5
61838 AV	227.3	206	190	4	0.5
61840 AV	240	216	200	4	0.5
61844 AV	260	236	220	4	0.5
61848 AV	290	259	240	5	0.5
61852 AV	310	279	260	5	0.5
61856 AV	340	302	280	5	0.5
N/A					
61864 AV	385	346	320	8	0.7

NILOS-Ring	i	c	D	h	s
61800 JV	11.6	16	19	1.5	0.3
61801 JV	13.6	18	21	1.5	0.3
61802 JV	16.6	21	24	1.8	0.3
61803 JV	18.6	23	26	1.8	0.3
61804 JV	22.4	28	32	2	0.3
61805 JV	27.4	33	37	2	0.3
61806 JV	32.4	38	42	2	0.3
61807 JV	37.1	43	47	2	0.3
61808 JV	42.5	48	52	2.5	0.3
61809 JV	47.2	54	58	2.5	0.3
61810 JV	53.1	60.5	65	2.5	0.3
61811 JV	58.1	67	72	2.5	0.3
61812 JV	64	72.5	78	2.5	0.3
61813 JV	69.1	79	85	2.5	0.3
61814 JV	74.5	84	90	2.5	0.3
61815 JV	79.1	89	95	2.5	0.3
61816 JV	84.5	94	100	2.5	0.3
61817 JV	90.4	103	110	2.5	0.3
61818 JV	95.4	108	115	2.5	0.3
61819 JV	100.6	113	120	3	0.3
61820 JV	105.6	118	125	3	0.3
61821 JV	110.4	123	130	3	0.5
61822 JV	116	130	140	3	0.5
61824 JV	126	141	150	3	0.5
61826 JV	137	156	165	3	0.5
61828 JV	148.5	164	175	3	0.5
61830 JV	159	178	190	4	0.5
61832 JV	169	188	200	4	0.5
61834 JV	180	201	215	4	0.5
61836 JV	191	212	225	4	0.5
61838 JV	203	224	240	4	0.5
61840 JV	210	235	250	4	0.5
61844 JV	230	255	270	4	0.5
61848 JV	250	282	300	5	0.5
61852 JV	272	302	320	5	0.5
61856 JV	295	329	350	5	0.5
61860 JV	315	355	380	5	0.5
N/A					

NILOS-Rings for single row deep groove ball bearings

Series 619

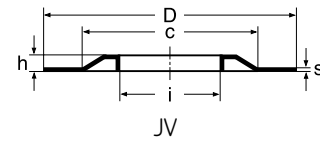
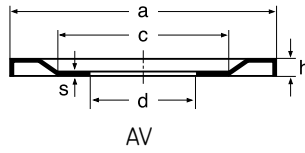
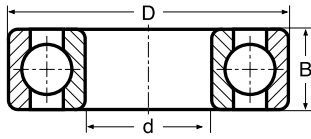

Bearing	d	D	B
61900	10	22	6
61901	12	24	6
61902	15	28	7
61903	17	30	7
61904	20	37	9
61905	25	42	9
61906	30	47	9
61907	35	55	10
61908	40	62	12
61909	45	68	12
61910	50	72	12
61911	55	80	13
61912	60	85	13
61913	65	90	13
61914	70	100	16
61915	75	105	16
61916	80	110	16
61917	85	120	18
61918	90	125	18
61919	95	130	18
61920	100	140	20
61921	105	145	20
61922	110	150	20
61924	120	165	22
61926	130	180	24
61928	140	190	24
61930	150	210	28
61932	160	220	28
61934	170	230	28
61936	180	250	33
61938	190	260	33
61940	200	280	38
61944	220	300	38
61948	240	320	38
61952	260	360	46
61956	280	380	46
61960	300	420	56

NILOS-Ring	a	c	d	h	s
61900 AV	19.8	14	10	1.8	0.3
61901 AV	21.8	16	12	1.8	0.3
61902 AV	26	19	15	1.8	0.3
61903 AV	27.5	22	17	1.8	0.3
61904 AV	34	25	20	2	0.3
61905 AV	39	31	25	2	0.3
61906 AV	44	36	30	2	0.3
61907 AV	51	42	35	2.5	0.3
61908 AV	57	47	40	2.5	0.3
61909 AV	63	52	45	2.5	0.3
61910 AV	68	57	50	2.5	0.3
61911 AV	75	63	55	2.5	0.3
61912 AV	80	68	60	2.5	0.3
61913 AV	84	72	65	3	0.3
61914 AV	94	83	70	3	0.3
61915 AV	98	84	75	3	0.3
61916 AV	104	92	80	3	0.3
61917 AV	113	99	85	3	0.3
61918 AV	117	105	90	3	0.3
61919 AV	123	109	95	3.5	0.5
61920 AV	132	118	100	3.5	0.5
61921 AV	136	120	105	3.5	0.5
61922 AV	142	127	110	3.5	0.5
61924 AV	156	140	120	3.5	0.5
61926 AV	170	151	130	4	0.5
61928 AV	180	161	140	4	0.5
61930 AV	198	172	150	4	0.5
61932 AV	208	186	160	4	0.5
61934 AV	218	195	170	4	0.5
61936 AV	240	206	180	4	0.5
61938 AV	245	216	190	4	0.5
61940 AV	262	232	200	5	0.5
61944 AV	285	235	220	5	0.5
61948 AV	305	273	240	5	0.5
61952 AV	345	296	260	5	0.5
61956 AV	365	318	280	5	0.5
61960 AV	400	342	300	8	0.7

NILOS-Ring	i	c	D	h	s
61900 JV	12.5	18	22	1.5	0.3
61901 JV	14.5	20	24	1.5	0.3
61902 JV	17.5	24	28	1.8	0.3
61903 JV	19.5	26	30	1.8	0.3
61904 JV	23	32	37	2	0.3
61905 JV	28	37	42	2	0.3
61906 JV	33	42	47	2	0.3
61907 JV	39.5	49	55	2	0.3
61908 JV	44	56	62	2.5	0.3
61909 JV	50	61	68	2.5	0.3
61910 JV	55	66	72	2.5	0.3
61911 JV	60	73	80	2.5	0.3
61912 JV	66	78	85	2.5	0.3
61913 JV	70	82	90	3	0.3
61914 JV	76	92	100	3	0.3
61915 JV	81	97	105	3	0.3
61916 JV	86	102	110	3	0.3
61917 JV	93	111	120	3	0.3
61918 JV	98	114	125	3	0.3
61919 JV	103	120	130	3.5	0.5
61920 JV	108	128	140	3.5	0.5
61921 JV	113	133	145	3.5	0.5
61922 JV	118	139	150	3.5	0.5
61924 JV	128	153	165	3.5	0.5
61926 JV	140	166	180	4	0.5
61928 JV	149	176	190	4	0.5
61930 JV	161	193	210	4	0.5
61932 JV	171	203	220	4	0.5
61934 JV	181	213	230	4	0.5
61936 JV	192	229	250	4	0.5
61938 JV	203	240	260	4	0.5
61940 JV	215	256	280	5	0.5
61944 JV	235	275	300	5	0.5
61948 JV	254	297	320	5	0.5
61952 JV	275	330	360	5	0.5
N/A					
61960 JV	318	385	420	8	0.5

NILOS-Rings for single row deep groove ball bearings

Series 62

Series 62 with shields or seals

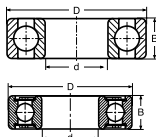

with shields or seals

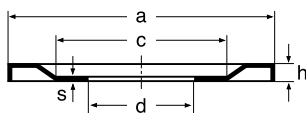

AV or ZAV

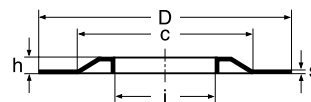

JV or ZJV

Bearing	d	D	B
6200	10	30	9
6201	12	32	10
6202	15	35	11
6203	17	40	12
6204	20	47	14
6205	25	52	15
6206	30	62	16
6207	35	72	17
6208	40	80	18
6209	45	85	19
6210	50	90	20
6211	55	100	21
6212	60	110	22
6213	65	120	23
6214	70	125	24
6215	75	130	25
6216	80	140	25
6217	85	150	28
6218	90	160	30
6219	95	170	32
6220	100	180	34
6221	105	190	36
6222	110	200	38
6224	120	215	40
6226	130	230	40
6228	140	250	42
6230	150	270	45
6232	160	290	48
6234	170	310	52
6236	180	320	52
6238	190	340	55
6240	200	360	58
6244	220	400	65
6248	240	440	72
6252	260	480	80
6260	300	540	85

NILOS-Ring	a	c	d	h	s
6200 AV	27.5	18	10	1.8	0.3
6201 AV	28.1	20	12	1.8	0.3
6202 AV	31.8	22	15	2	0.3
6203 AV	35.7	25	17	2	0.3
6204 AV	41.2	29	20	2	0.3
6205 AV	47	36	25	2.5	0.3
6206 AV	56.2	44	30	2.5	0.3
6207 AV	64.8	48	35	2.5	0.3
6208 AV	72.7	57	40	3	0.3
6209 AV	77.8	61	45	3	0.3
6210 AV	82.8	67	50	3	0.3
6211 AV	90.8	75	55	3	0.3
6212 AV	100.8	85	60	3	0.3
6213 AV	110.5	90	65	3	0.3
6214 AV	115.8	95	70	3.5	0.3
6215 AV	120.5	100	75	3.5	0.5
6216 AV	129	106	80	3.5	0.5
6217 AV	138.5	115	85	3.5	0.5
6218 AV	148	124	90	3.5	0.5
6219 AV	157.5	130	95	3.5	0.5
6220 AV	167	135	100	4	0.5
6221 AV	174	140	105	4	0.5
6222 AV	184	150	110	4	0.5
6224 AV	199	165	120	4	0.5
6226 AV	214	173	130	4	0.5
6228 AV	229	183	140	4	0.5
6230 AV	248	200	150	4	0.5
6232 AV	267	220	160	5	0.5
6234 AV	286	235	170	5	0.5
6236 AV	295	237	180	5	0.5
6238 AV	314	260	190	5	0.5
6240 AV	335	280	200	5	0.5
6244 AV	369	285	220	5.8	0.7
6248 AV	390	345	240	5.3	0.7
6252 AV	400	388	260	8	0.7
N/A					

NILOS-Ring	i	c	D	h	s
6000 JV	14.4	24	30	1.8	0.3
6201 JV	16.4	26	32	1.8	0.3
6202 JV	18.6	27	35	2	0.3
6203 JV	21.5	31	40	2	0.3
6204 JV	25.7	37	47	2	0.3
6205 JV	31.5	42	52	2.5	0.3
6206 JV	36.3	47	62	2.5	0.3
6207 JV	43	56	72	2.5	0.3
6208 JV	48	62	80	3	0.3
6209 JV	53	68	85	3	0.3
6210 JV	57.5	73	90	3	0.3
6211 JV	64.5	80	100	3	0.3
6212 JV	70	85	110	3	0.3
6213 JV	74.5	95	120	3	0.3
6214 JV	79.5	102	125	3.5	0.3
6215 JV	85	105	130	3.5	0.5
6216 JV	92	112	140	3.5	0.5
6217 JV	98	125	150	3.5	0.5
6218 JV	103	125	160	3.5	0.5
6219 JV	110	137	170	3.5	0.5
6220 JV	115	145	180	4	0.5
6221 JV	119.5	158	190	4	0.5
6222 JV	125.5	165	200	4	0.5
6224 JV	134	175	215	4	0.5
6226 JV	147	190	230	4	0.5
6228 JV	160	200	250	4	0.5
6230 JV	172	220	270	4	0.5
6232 JV	184	240	290	5	0.5
6234 JV	200	261	310	5	0.5
6236 JV	205	265	320	5	0.5
6238 JV	212	285	340	5	0.5
6240 JV	220	305	360	5	0.5
6244 JV	260	380	400	7	0.7
6248 JV	260	380	440	7	0.7
N/A					
6260 JV	350	470	540	8	0.7

series 62 with shields or seals

6200 Z/RS	10	30	9
6201 Z/RS	12	32	10
6202 Z/RS	15	35	11
6203 Z/RS	17	40	12
6204 Z/RS	20	47	14
6205 Z/RS	25	52	15
6206 Z/RS	30	62	16
6207 Z/RS	35	72	17
6208 Z/RS	40	80	18
6209 Z/RS	45	85	19
6210 Z/RS	50	90	20
6211 Z/RS	55	100	21
6212 Z/RS	60	110	22
6213 Z/RS	65	120	23
6214 Z/RS	70	125	24
6216 Z/RS	80	140	26

6200 ZAV	27.5	18	10	1.8	0.3
6201 ZAV	28.9	20	12	1.8	0.3
6202 ZAV	31.8	22	15	2	0.3
6203 ZAV	36.5	26	17	2	0.3
6204 ZAV	41.9	29	20	2	0.3
6205 ZAV	47.8	35	25	2.5	0.3
6206 ZAV	56.2	44	30	2.5	0.3
6207 ZAV	64.8	48	35	2.5	0.3
6208 ZAV	72.7	57	40	3	0.3
6209 ZAV	77.8	61	45	3	0.3
6210 ZAV	82.8	67	50	3	0.3
6211 ZAV	92.5	75	55	3	0.3
6212 ZAV	103	83	60	3	0.3
6213 ZAV	110.5	90	65	3	0.3
6214 ZAV	117.5	95	70	3	0.3
6216 ZAV	132	105	80	3.5	0.5

6200 ZJV	13.5	26	30	1.8	0.3
6201 ZJV	14.4	26	32	1.8	0.3
6202 ZJV	18.6	27	35	2	0.3
6203 ZJV	20.2	31	40	2	0.3
6204 ZJV	24.7	37	47	2	0.3
6205 ZJV	30	42	52	2.5	0.3
6206 ZJV	36.3	47	62	2.5	0.3
6207 ZJV	42.7	56	72	2.5	0.3
6208 ZJV	48	62	80	3	0.3
6209 ZJV	53	68	85	3	0.3
6210 ZJV	56.6	73	90	3	0.3
6211 ZJV	63	80	100	3	0.3
6212 ZJV	69.5	85	110	3	0.3
6213 ZJV	74.5	95	120	3	0.3
6214 ZJV	79.5	102	125	3.5	0.3
N/A					

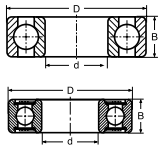

with shields or seals

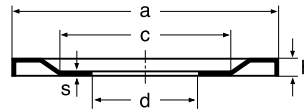

AV or ZAV

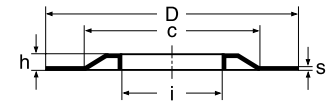

JV or ZJV

Bearing	d	D	B
6300	10	35	11
6301	12	37	12
6302	15	42	13
6303	17	47	14
6304	20	52	15
6305	25	62	17
6306	30	72	19
6307	35	80	21
6308	40	90	23
6309	45	100	25
6310	50	110	27
6311	55	120	29
6312	60	130	31
6313	65	140	33
6314	70	150	35
6315	75	160	37
6316	80	170	39
6317	85	180	41
6318	90	190	43
6319	95	200	45
6320	105	215	47
6321	100	225	49
6322	110	240	50
6324	120	260	55
6326	130	280	58
6328	140	300	62
6330	150	320	65
6332	160	340	68
6334	170	360	72
6336	180	380	75
6338	190	400	78
6340	200	420	80
6344	220	460	88

NILOS-Ring	a	c	d	h	s
6300 AV	30.6	20	10	2	0.3
6301 AV	32.7	23	12	2	0.3
6302 AV	36.5	26	15	2	0.3
6303 AV	41.2	29	17	2	0.3
6304 AV	44.8	33	20	2	0.3
6305 AV	54.8	40	25	2.5	0.3
6306 AV	64.8	48	30	2.5	0.3
6307 AV	70.7	54	35	2.5	0.3
6308 AV	80.5	60	40	3	0.3
6309 AV	90.8	75	45	3	0.3
6310 AV	98.9	80	50	3	0.3
6311 AV	108	89	55	3	0.3
6312 AV	117.5	95	60	3	0.3
6313 AV	127.5	100	65	3.5	0.5
6314 AV	137	110	70	3.5	0.5
6315 AV	147	110	75	3.5	0.5
6316 AV	157.5	130	80	3.5	0.5
6317 AV	164	135	85	4	0.5
6318 AV	174	140	90	4	0.5
6319 AV	184	150	95	4	0.5
6320 AV	199	165	100	4	0.5
6321 AV	208	174	105	4	0.5
6322 AV	219	179	110	4	0.5
6324 AV	239	190	120	4	0.5
6326 AV	251	200	130	5	0.5
6328 AV	267	220	140	5	0.5
6330 AV	286	235	150	5	0.5
6332 AV	314	260	160	5	0.5
6334 AV	320	268	170	5	0.5
6336 AV	335	280	180	5	0.5
6338 AV	369	285	190	5.8	0.7
6340 AV	369	285	200	5.8	0.7
6344 AV	N/A				

NILOS-Ring	i	c	D	h	s
6300 JV	15.5	27	35	2	0.3
6301 JV	17.5	29	37	2	0.3
6302 JV	20.8	33	42	2	0.3
6303 JV	23	36	47	2	0.3
6304 JV	27.2	40	52	2	0.3
6305 JV	32.2	47	62	2.5	0.3
6306 JV	37.2	56	72	2.5	0.3
6307 JV	45	65	80	2.5	0.3
6308 JV	51	70	90	3	0.3
6309 JV	56	80	100	3	0.3
6310 JV	62	86	110	3	0.3
6311 JV	67	93	120	3	0.3
6312 JV	73	102	130	3	0.5
6313 JV	77.5	110	140	3.5	0.5
6314 JV	82.6	120	150	3.5	0.5
6315 JV	87.2	125	160	3.5	0.5
6316 JV	95	138	170	3.5	0.5
6317 JV	100	140	180	4	0.5
6318 JV	106	150	190	4	0.5
6319 JV	115	160	200	4	0.5
6320 JV	118	170	215	4	0.5
6321 JV	127	180	225	4	0.5
6322 JV	133	197	240	4	0.5
6324 JV	142	205	260	4	0.5
6326 JV	148	225	280	5	0.5
6328 JV	165	235	300	5	0.5
6330 JV	172	255	320	5	0.5
6332 JV	185	276	340	5	0.5
6334 JV	200	295	360	5	0.5
6336 JV	222	330	380	6.5	0.7
6338 JV	222	330	400	6.5	0.7
6340 JV	260	380	420	7	0.7
6344 JV	260	380	460	7	0.7

series 63 with shields or seals

6300 Z/RS	10	35	11
6301 Z/RS	12	37	12
6302 Z/RS	15	42	13
6303 Z/RS	17	47	14
6304 Z/RS	20	52	15
6305 Z/RS	25	62	17
6306 Z/RS	30	72	19
6307 Z/RS	35	80	21
6308 Z/RS	40	90	23
6309 Z/RS	45	100	25
6310 Z/RS	50	110	27
6311 Z/RS	55	120	29
6312 Z/RS	60	130	31
6313 Z/RS	65	140	33
6314 Z/RS	70	150	35

6300 ZAV	30.6	20	10	2	0.3
6301 ZAV	32.7	23	12	2	0.3
6302 ZAV	36.5	26	15	2	0.3
6303 ZAV	41.2	29	17	2	0.3
6304 ZAV	44.8	33	20	2	0.3
6305 ZAV	54.8	40	25	2.5	0.3
6306 ZAV	64.8	48	30	2.5	0.3
6307 ZAV	71.2	54	35	2.5	0.3
6308 ZAV	80.5	60	40	3	0.3
6309 ZAV	90.8	75	45	3	0.3
6310 ZAV	98.9	80	50	3	0.3
6311 ZAV	108	89	55	3	0.3
6312 ZAV	117.5	95	60	3	0.3
6313 ZAV	127.5	100	65	3.5	0.5
6314 ZAV	137	110	70	3.5	0.5

6300 ZJV	14.5	27	35	2	0.3
6301 ZJV	16.4	26	37	2	0.3
6302 ZJV	19	32	42	2	0.3
6303 ZJV	23	36	47	2	0.3
6304 ZJV	25.7	40	52	2.5	0.3
6305 ZJV	32.2	47	62	2.5	0.3
6306 ZJV	37.2	56	72	2.5	0.3
6307 ZJV	43.1	65	80	2.5	0.3
6308 ZJV	49.1	70	90	3	0.3
6309 ZJV	54	81	100	3	0.3
6310 ZJV	62	86	110	3	0.3
6311 ZJV	67	93	120	3	0.3
6312 ZJV	73	102	130	3	0.5
6313 ZJV	77.5	110	140	3.5	0.5
6314 ZJV	82.6	120	150	3.5	0.5

NILOS-Rings for single row deep groove ball bearings

Series 64
Series 161
Series 160

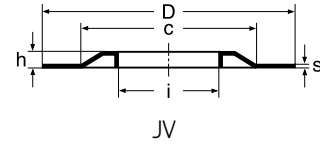
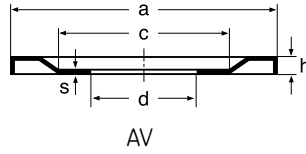
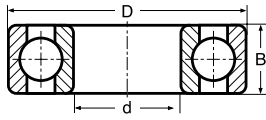

Bearing	d	D	B
6403	17	62	17
6404	20	72	19
6405	25	80	21
6406	40	90	23
6407	35	100	25
6408	40	110	27
6409	45	120	29
6410	50	130	31
6411	55	140	33
6412	60	150	35
6413	65	160	37
6414	70	180	42
6415	75	190	45
6416	80	200	48
6417	85	210	52
6418	90	225	54

NILOS-Ring	a	c	d	h	s
6403 AV	54	36	17	2.5	0.3
6404 AV	62.2	51	20	2.5	0.3
6405 AV	69	55	25	2.5	0.3
6406 AV	77.8	61	30	3	0.3
6407 AV	88	71	35	3	0.3
6408 AV	94.8	75	40	3	0.3
6409 AV	105.8	84	45	3	0.3
6410 AV	115.8	95	50	3.5	0.3
6411 AV	125.8	95	55	3.5	0.5
6412 AV	133.5	100	60	3.5	0.5
6413 AV	143.5	110	65	3.5	0.5
6414 AV	162	123	70	3.5	0.5
6415 AV	169	140	75	4	0.5
6416 AV	180	140	80	4	0.5
6417 AV	188	155	85	4	0.5
6418 AV	199	165	90	4	0.5

NILOS-Ring	i	c	D	h	s
6403 JV	28	43	62	2.5	0.3
6404 JV	31.2	55	72	2.5	0.3
6405 JV	36.2	62	80	2.5	0.3
6406 JV	42	68	90	3	0.3
6407 JV	47	77	100	3	0.3
6408 JV	54	81	110	3	0.3
6409 JV	58.2	94	120	3	0.3
6410 JV	65 a103	130	130	3.5	0.5
6411 JV	70.5	110	140	3.5	0.5
6412 JV	75.5	115	150	3.5	0.5
6413 JV	81	125	160	3.5	0.5
6414 JV	89	131	180	3.5	0.5
6415 JV	93	141	190	4	0.5
6416 JV	100	150	200	4	0.5
6417 JV	106	155	210	4	0.5
6418 JV	112.5	165	225	4	0.5

16100
16101

10 28 8
12 30 8

16100 AV
16101 AV

25.5 17 10 1.8 0.3
28.1 20 12 1.8 0.3

16100 JV
16101 JV

13 23 28 1.8 0.3
15 24 30 1.8 0.3

16002
16003
16004
16005
16006
16007
16008
16009
16010
16011
16012
16013
16014
16015
16016
16017
16018
16019
16020
16021
16022
16024
16026
16028
16030
16032
16034
16036
16038
16040
16044
16048
16052
16056
16060

15 32 8
17 35 8
20 42 8
25 47 8
30 55 9
35 62 9
40 68 9
45 75 10
50 80 10
55 90 11
60 95 11
65 100 11
70 110 13
75 115 13
80 125 14
85 130 14
90 140 16
95 145 16
100 150 16
105 160 18
110 170 19
120 180 19
130 200 22
140 210 22
150 225 24
160 240 25
170 260 28
180 280 31
190 290 31
200 310 34
220 340 37
240 360 37
260 400 44
280 420 44
300 460 50

16002 AV
16003 AV
16004 AV
16005 AV
16006 AV
16007 AV
16008 AV
16009 AV
16010 AV
16011 AV
16012 AV
16013 AV
16014 AV
16015 AV
16016 AV
16017 AV
16018 AV
16019 AV
16020 AV
16021 AV
16022 AV
16024 AV
16026 AV
16028 AV
16030 AV
16032 AV
16034 AV
16036 AV
16038 AV
16040 AV
16044 AV
16048 AV
16052 AV
16056 AV
16060 AV

29.5 21 15 2 0.3
32.7 24 17 2 0.3
37.8 28 20 2 0.3
43.7 34 25 2.5 0.3
50 40 30 2.5 0.3
56.2 44 35 2.5 0.3
62.2 51 40 2.5 0.3
69.7 56 45 2.5 0.3
74.6 61 50 2.5 0.3
83.5 67 55 3 0.3
88 71 60 3 0.3
93.5 78 65 3 0.3
103 83 70 3 0.3
108 89 75 3 0.3
117.5 95 80 3 0.3
123 104 85 3.5 0.5
129 106 90 3.5 0.5
137 110 95 3.5 0.5
142 117 100 3.5 0.5
148 124 105 3.5 0.5
157.5 130 110 3.5 0.5
169 140 120 4 0.5
188 155 130 4 0.5
199 165 140 4 0.5
214 173 150 4 0.5
229 183 160 4 0.5
248 200 170 4 0.5
267 220 180 5 0.5
275 220 190 5 0.5
286 235 200 5 0.5
314 260 220 5 0.5
335 280 240 5 0.5
369 285 260 5.8 0.7
390 345 280 5.3 0.7
440 388 300 8 0.7

16002 JV
16003 JV
16004 JV
16005 JV
16006 JV
16007 JV
16008 JV
16009 JV
16010 JV
16011 JV
16012 JV
16013 JV
16014 JV
16015 JV
16016 JV
16017 JV
16018 JV
16019 JV
16020 JV
16021 JV
16022 JV
16024 JV
16026 JV
16028 JV
16030 JV
16032 JV
16034 JV
16036 JV
16038 JV
16040 JV
16044 JV
16048 JV
16052 JV
16056 JV
16060 JV

17.5 27 32 2 0.3
19.5 28 35 2 0.3
24.5 34 42 2 0.3
29 38 47 2.5 0.3
35 46 55 2.5 0.3
40.2 52 62 2.5 0.3
46 57 68 2.5 0.3
51 63 75 2.5 0.3
56 67 80 2.5 0.3
61.5 74 90 3 0.3
67 80 95 3 0.3
74 86.5 100 3 0.3
77 90 110 3 0.3
82 95 115 3 0.3
86.5 105 125 3 0.3
91.5 110 130 3.5 0.5
98 118 140 3.5 0.5
103 123 145 3.5 0.5
108 128 150 3.5 0.5
116.5 137 160 3.5 0.5
120 145 170 3.5 0.5
130 150 180 4 0.5
140 170 200 4 0.5
152 175 210 4 0.5
164 185 225 4 0.5
174 200 240 4 0.5
185 215 260 4 0.5
200 230 280 5 0.5
203 243 290 5 0.5
220 255 310 5 0.5
250 285 340 5.3 0.5
260 315 360 5.8 0.5
290 342 400 6.2 0.7
310 360 420 7.7 0.7
330 406 460 6.7 0.7

NILOS-Rings for double row deep groove ball bearings

Series 42
Series 43

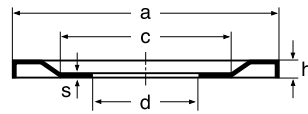
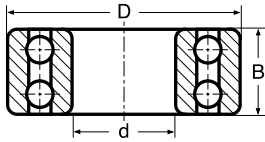

AV

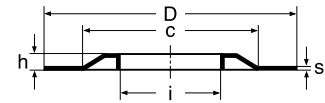

JV

Bearing	d	D	B
4200	10	30	14
4201	12	32	14
4202	15	35	14
4203	17	40	16
4204	20	47	18
4205	25	52	18
4206	30	62	20
4207	35	72	23
4208	40	80	23
4209	45	85	23
4210	50	90	23
4211	55	100	25
4212	60	110	28
4213	65	120	31
4214	70	125	31
4215	75	130	31

NILOS-Ring	a	c	d	h	s
4200 AV	27.5	18	10	1.8	0.3
4201 AV	30	20	12	1.8	0.3
4202 AV	32.8	22	15	2	0.3
4203 AV	36.8	26	17	2	0.3
4204 AV	43.7	34	20	2.5	0.3
4205 AV	47.8	35	25	2.5	0.3
4206 AV	56.2	44	30	2.5	0.3
4207 AV	67.8	48	35	2.5	0.3
4208 AV	72.7	57	40	3	0.3
4209 AV	77.8	61	45	3	0.3
4210 AV	82.8	67	50	3	0.3
4211 AV	93.5	76	55	3	0.3
4212 AV	100.8	85	60	3	0.3
4213 AV	110.5	90	65	3	0.3
4214 AV	115.8	95	70	3.5	0.3
4215 AV	120.5	100	75	3.5	0.5

NILOS-Ring	i	c	D	h	s
4200 JV	13.5	24	30	1.8	0.3
4201 JV	16.4	26	32	1.8	0.3
4202 JV	17.3	27	35	2	0.3
4203 JV	20.2	31	40	2	0.3
4204 JV	25.7	37	47	2	0.3
4205 JV	31.5	42	52	2.5	0.3
4206 JV	36.3	47	62	2.5	0.3
4207 JV	43	56	72	2.5	0.3
4208 JV	48	62	80	3	0.3
4209 JV	53	68	85	3	0.3
4210 JV	57.5	73	90	3	0.3
4211 JV	64.5	80	100	3	0.3
4212 JV	70	85	110	3	0.3
4213 JV	74.5	95	120	3	0.3
4214 JV	79.5	102	125	3.5	0.3
4215 JV	85	105	130	3.5	0.5

4300	10	35	17
4301	12	37	17
4302	15	42	17
4303	17	47	19
4304	20	52	21
4305	25	62	24
4306	30	72	27
4307	35	80	31
4308	40	90	33
4309	45	100	36
4310	50	110	40
4311	55	120	43
4312	60	130	46
4313	65	140	48
4314	70	150	51
4315	75	160	55
4316	80	170	58
4317	85	180	60
4318	90	190	64
4319	95	200	67
4320	100	215	73
4321	105	225	77
4322	110	240	80

4300 AV	30.6	20	10	2	0.3
4301 AV	32.7	23	12	2	0.3
4302 AV	36.5	26	15	2	0.3
4303 AV	41.2	29	17	2	0.3
4304 AV	44.8	33	20	2	0.3
4305 AV	54.8	40	25	2.5	0.3
4306 AV	64.8	48	30	2.5	0.3
4307 AV	70.7	54	35	2.5	0.3
4308 AV	80.5	60	40	3	0.3
4309 AV	90.8	75	45	3	0.3
4310 AV	98.9	80	50	3	0.3
4311 AV	108	89	55	3	0.3
4312 AV	117.5	95	60	3	0.3
4313 AV	127.5	100	65	3.5	0.5
4314 AV	137	110	70	3.5	0.5
4315 AV	147	110	75	3.5	0.5
4316 AV	157.5	130	80	3.5	0.5
4317 AV	164	135	85	4	0.5
4318 AV	174	140	90	4	0.5
4319 AV	184	150	95	4	0.5
4320 AV	199	165	100	4	0.5
4321 AV	208	174	105	4	0.5

4300 JV	15.5	27	35	2	0.3
4301 JV	17.5	29	37	2	0.3
4302 JV	20.8	33	42	2	0.3
4303 JV	23	36	47	2	0.3
4304 JV	27.2	40	52	2	0.3
4305 JV	32.2	47	62	2.5	0.3
4306 JV	37.2	56	72	2.5	0.3
4307 JV	45	65	80	2.5	0.3
4308 JV	51	70	90	3	0.3
4309 JV	56	80	100	3	0.3
4310 JV	62	96	110	3	0.3
4311 JV	67	93	120	3	0.5
4312 JV	73	102	130	3	0.5
4313 JV	77.5	110	140	3.5	0.5
4314 JV	82.6	120	150	3.5	0.5
4315 JV	87.2	125	160	3.5	0.5
4316 JV	95	138	170	3.5	0.5
4317 JV	100	140	180	4	0.5
4318 JV	106	150	190	4	0.5
4319 JV	115	160	200	4	0.5
4320 JV	118	170	215	4	0.5
4321 JV	127	180	225	4	0.5
4322 JV	133	197	240	4	0.5

NILOS-Rings for single row angular contact ball bearings

Series 70 side G

Series 70 side H

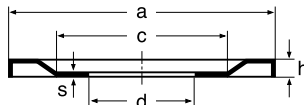
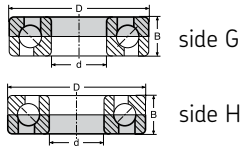

AVG or AVH

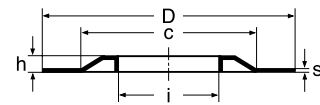

JVG or JVH

Bearing	d	D	B
Series 70 side G			
7000	10	26	8
7001	12	28	8
7002	15	32	9
7003	17	35	10
7004	20	42	12
7005	25	47	12
7006	30	55	13
7007	35	62	14
7008	40	68	15
7009	45	75	16
7010	50	80	16
7011	55	90	18
7012	60	95	18
7013	65	100	18
7014	70	110	20
7015	75	115	20
7016	80	125	22
7017	85	130	22
7018	90	140	24

NILOS-Ring	a	c	d	h	s
7000 AVG	23.5	15	10	1.8	0.3
70a01 AVG	25.5	17	12	1.8	0.3
7002 AVG	29.5	21	15	2	0.3
7003 AVG	32.7	24	17	2	0.3
7004 AVG	36.8	26	20	2	0.3
7005 AVG	41.8	33.5	25	2.5	0.3
7006 AVG	47.8	35	30	2.5	0.3
7007 AVG	56.2	44	35	2.5	0.3
7008 AVG	62.2	51	40	2.5	0.3
7009 AVG	69	55	45	2.5	0.3
7010 AVG	72.7	57	50	3	0.3
7011 AVG	82.8	67	55	3	0.3
7012 AVG	88	71	60	3	0.3
7013 AVG	90.8	75	65	3	0.3
7014 AVG	103	83	70	3	0.3
7015 AVG	108	89	75	3	0.3
7016 AVG	117.5	95	80	3	0.3
7017 AVG	123	104	85	3.5	0.5
7018 AVG	129	106	90	3.5	0.5

NILOS-Ring	i	c	D	h	s
7000 JVG	12.3	22	26	1.8	0.3
7001 JVG	15	23	28	1.8	0.3
7002 JVG	17.5	27	32	2	0.3
7003 JVG	19.5	28	35	2	0.3
7004 JVG	24	37	42	2	0.3
7005 JVG	29	38	47	2.5	0.3
7006 JVG	35	46	55	2.5	0.3
7007 JVG	40.2	52	62	2.5	0.3
7008 JVG	45.3	57	68	2.5	0.3
7009 JVG	51	63	75	2.5	0.3
7010 JVG	56	67	80	2.5	0.3
7011 JVG	61.5	74	90	3	0.3
7012 JVG	64.5	80	95	3	0.3
7013 JVG	70	88	100	3.5	0.3
7014 JVG	77	90	110	3	0.3
7015 JVG	82	95	115	3	0.3
7016 JVG	86.5	105	125	3	0.3
7017 JVG	91.5	110	130	3.5	0.5
7018 JVG	98	118	140	3.5	0.5

Series 70 side H

7000	10	26	8
7001	12	28	8
7002	15	32	9
7003	17	35	10
7004	20	42	12
7005	25	47	12
7006	30	55	13
7007	35	62	14
7008	40	68	15
7009	45	75	16
7010	50	80	16
7011	55	90	18
7012	60	95	18
7013	65	100	18
7014	70	110	20
7015	75	115	20
7016	80	125	22
7017	85	130	22
7018	90	140	24

7000 AVH	24.3	15	10	1.8	0.3
7001 AVH	26.3	17	12	1.8	0.3
7002 AVH	29.5	21	15	2	0.3
7003 AVH	32.7	24	17	2	0.3
7004 AVH	39.5	27	20	2	0.3
7005 AVH	44.8	33.5	25	2	0.3
7006 AVH	51.5	35	30	2.5	0.3
7007 AVH	58.8	44	35	2.5	0.3
7008 AVH	64.8	51	40	2.5	0.3
7009 AVH	70.7	55	45	2.5	0.3
7010 AVH	77.8	57	50	3	0.3
7011 AVH	85.8	67	55	3	0.3
7012 AVH	90.8	71	60	3	0.3
7013 AVH	95.7	75	65	3	0.3
7014 AVH	104.8	83	70	3	0.3
7015 AVH	110.5	89	75	3	0.3
7016 AVH	120.5	95	80	3.5	0.3
7017 AVH	124.8	105	85	3.5	0.5
7018 AVH	137	106	90	3.5	0.5

7000 JVH	12.3	22	26	1.8	0.3
7001 JVH	15	23	28	1.8	0.3
7002 JVH	17.5	27	32	2	0.3
7003 JVH	19.5	28	35	2	0.3
7004 JVH	25.7	37	42	2	0.3
7005 JVH	31	39	47	2.5	0.3
7006 JVH	36.3	47	55	2.5	0.3
7007 JVH	42	52	62	2.5	0.3
7008 JVH	46	57	68	2.5	0.3
7009 JVH	51	63	75	2.5	0.3
7010 JVH	56	67	80	2.5	0.3
7011 JVH	64.5	80	90	3	0.3
7012 JVH	70	85	95	3	0.3
7013 JVH	72	84	100	3	0.3
7014 JVH	77	90	110	3	0.3
7015 JVH	82	95	115	3	0.3
7016 JVH	86.5	105	125	3	0.3
7017 JVH	91.5	110	130	3.5	0.5
7018 JVH	98	118	140	3.5	0.5

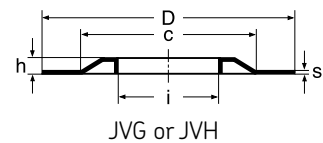
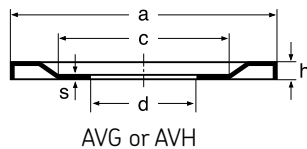
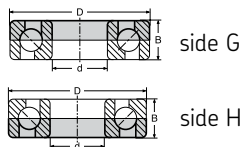

Bearing	d	D	B
Series 72 side G			
7200	10	30	9
7201	12	32	10
7202	15	35	11
7203	17	40	12
7204	20	47	14
7205	25	52	15
7206	30	62	16
7207	35	72	17
7208	40	80	18
7209	45	85	19
7210	50	90	20
7211	55	100	21
7212	60	110	22
7213	65	120	23
7214	70	125	24
7215	75	130	25
7216	80	140	26
7217	85	150	28
7218	90	160	30
7219	95	170	32
7220	100	180	34
7221	105	190	36
7222	110	200	38

NILOS-Ring	a	c	d	h	s
7200 AVG	27.5	18	10	1.8	0.3
7201 AVG	28.1	20	12	1.8	0.3
7202 AVG	31.8	22	15	2	0.3
7203 AVG	35.7	25	17	2	0.3
7204 AVG	41.2	29	20	2	0.3
7205 AVG	47	36	25	2.5	0.3
7206 AVG	56.2	44	30	2.5	0.3
7207 AVG	64.8	48	35	2.5	0.3
7208 AVG	72.7	57	40	3	0.3
7209 AVG	77.8	61	45	3	0.3
7210 AVG	82.8	67	50	3	0.3
7211 AVG	90.8	75	55	3	0.3
7212 AVG	100.8	85	60	3	0.3
7213 AVG	110.5	90	65	3	0.3
7214 AVG	115.8	95	70	3.5	0.3
7215 AVG	120.5	100	75	3.5	0.5
7216 AVG	129	106	80	3.5	0.5
7217 AVG	138.5	115	85	3.5	0.5
7218 AVG	148	124	90	3.5	0.5
7219 AVG	157.5	130	95	3.5	0.5
7220 AVG	167	135	100	4	0.5
7221 AVG	174	140	105	4	0.5
7222 AVG	184	150	110	4	0.5

NILOS-Ring	i	c	D	h	s
7200 JVG	13.5	24	30	1.8	0.3
7201 JVG	14.4	26	32	1.8	0.3
7202 JVG	17.3	27	35	2	0.3
7203 JVG	20.2	31	40	2	0.3
7204 JVG	23.2	37	47	2	0.3
7205 JVG	28	42	52	2.5	0.3
7206 JVG	33	49	62	2.5	0.3
7207 JVG	39.2	56	72	2.5	0.3
7208 JVG	45	65	80	2.5	0.3
7209 JVG	49.4	68	85	3	0.3
7210 JVG	54.5	72	90	3	0.3
7211 JVG	60	80	100	3	0.3
7212 JVG	67	93	110	3	0.3
7213 JVG	72.5	95	120	3	0.3
7214 JVG	76.5	100	125	3.5	0.3
7215 JVG	81	105	130	3.5	0.5
7216 JVG	87.2	110	140	3.5	0.5
7217 JVG	92.3	117	150	3.5	0.5
7218 JVG	97.8	125	160	3.5	0.5
7219 JVG	103	150	170	3.5	0.5
7220 JVG	109.5	160	180	4	0.5
7221 JVG	115	160	190	4	0.5
7222 JVG	120	170	200	4	0.5

Series 72 side H

7200	10	30	9
7201	12	32	10
7202	15	35	11
7203	17	40	12
7204	20	47	14
7205	25	52	15
7206	30	62	16
7207	35	72	17
7208	40	80	18
7209	45	85	19
7210	50	90	20
7211	55	100	21
7212	60	110	22
7213	65	120	23
7214	70	125	24
7215	75	130	25
7216	80	140	26
7217	85	150	28
7218	90	160	30
7219	95	170	32
7220	100	180	34
7221	105	190	36
7222	110	200	38

7200 AVH	27.5	18	10	1.8	0.3
7201 AVH	30	20	12	1.8	0.3
7202 AVH	33.8	23	15	2	0.3
7203 AVH	38	28	17	2	0.3
7204 AVH	44.8	33	20	2	0.3
7205 AVH	48.8	35	25	2.5	0.3
7206 AVH	58.8	44	30	2.5	0.3
7207 AVH	67.8	48	35	2.5	0.3
7208 AVH	75.8	54	40	3	0.3
7209 AVH	80.5	60	45	3	0.3
7210 AVH	86.5	64	50	3	0.3
7211 AVH	94.8	75	55	3	0.3
7212 AVH	105.8	84	60	3	0.3
7213 AVH	114.8	88	65	3	0.3
7214 AVH	119.8	90	70	3.5	0.3
7215 AVH	124.8	94	75	3.5	0.5
7216 AVH	133.5	100	80	3.5	0.5
7217 AVH	143.5	110	85	3.5	0.5
7218 AVH	153.5	115	90	3.5	0.5
7219 AVH	162	123	95	3.5	0.5
7220 AVH	172	130	100	4	0.5
7221 AVH	183	135	105	4	0.5
7222 AVH	192	155	110	4	0.5

7200 JVH	14.4	24	30	1.8	0.3
7201 JVH	16.4	26	32	1.8	0.3
7202 JVH	18.6	27	35	2	0.3
7203 JVH	21.5	31	40	2	0.3
7204 JVH	25.7	37	47	2	0.3
7205 JVH	31.5	42	52	2.5	0.3
7206 JVH	36.3	47	62	2.5	0.3
7207 JVH	43	56	72	2.5	0.3
7208 JVH	48	62	80	3	0.3
7209 JVH	53	68	85	3	0.3
7210 JVH	57.5	73	90	3	0.3
7211 JVH	64.5	80	100	3	0.3
7212 JVH	70	85	110	3	0.3
7213 JVH	74.5	95	120	3	0.3
7214 JVH	79.5	102	125	3.5	0.3
7215 JVH	85	105	130	3.5	0.5
7216 JVH	92	112	140	3.5	0.5
7217 JVH	98	125	150	3.5	0.5
7218 JVH	103	125	160	3.5	0.5
7219 JVH	110	137	170	3.5	0.5
7220 JVH	115	145	180	4	0.5
7221 JVH	119.5	158	190	4	0.5
7222 JVH	125.5	165	200	4	0.5

NILOS-Rings for single row angular contact ball bearings

Series 73 side G

Series 73 side H

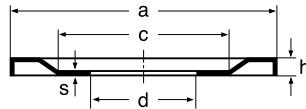
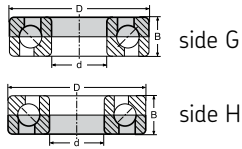

AVG or AVH

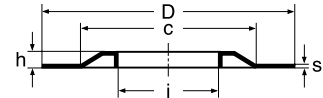

JVG or JVH

Bearing	d	D	B
Series 73 side G			
7300	10	35	11
7301	12	37	12
7302	15	42	13
7303	17	47	14
7304	20	52	15
7305	25	62	17
7306	30	72	19
7307	35	80	21
7308	40	90	23
7309	45	100	25
7310	50	110	27
7311	55	120	29
7312	60	130	31
7313	65	140	33
7314	70	150	35
7315	75	160	37
7316	80	170	39
7317	85	180	41
7318	90	190	43
7319	95	200	45
7320	100	215	47
7321	105	225	49
7322	110	240	50

NILOS-Ring	a	c	d	h	s
7300 AVG	30.6	20	10	2	0.3
7301 AVG	32.7	23	12	2	0.3
7302 AVG	36.5	26	15	2	0.3
7303 AVG	41.2	29	17	2	0.3
7304 AVG	44.8	33	20	2	0.3
7305 AVG	54.8	40	25	2.5	0.3
7306 AVG	64.8	48	30	2.5	0.3
7307 AVG	70.7	54	35	2.5	0.3
7308 AVG	80.5	60	40	3	0.3
7309 AVG	90.8	75	45	3	0.3
7310 AVG	98.9	80	50	3	0.3
7311 AVG	108	89	55	3	0.3
7312 AVG	117.5	95	60	3	0.3
7313 AVG	127.5	100	65	3.5	0.5
7314 AVG	137	110	70	3.5	0.5
7315 AVG	147	110	75	3.5	0.5
7316 AVG	157.5	130	80	3.5	0.5
7317 AVG	164	135	85	4	0.5
7318 AVG	174	140	90	4	0.5
7319 AVG	184	150	95	4	0.5
7320 AVG	199	165	100	4	0.5
7321 AVG	208	174	105	4	0.5
7322 AVG	219	179	110	4	0.5

NILOS-Ring	i	C	D	h	s
7300 JVG	14	26	35	2	0.3
7301 JVG	15.2	26	37	2	0.3
7302 JVG	19	32	42	2	0.3
7303 JVG	20.5	36	47	2	0.3
7304 JVG	24.5	40	52	2	0.3
7305 JVG	30	46	62	2.5	0.3
7306 JVG	37.2	56	72	2.5	0.3
7307 JVG	41.9	60	80	3	0.3
7308 JVG	47.5	70	90	3	0.3
7309 JVG	52.3	80	100	3	0.3
7310 JVG	57.5	83	110	3	0.3
7311 JVG	64	90	120	3	0.3
7312 JVG	69.3	101	130	3	0.5
7313 JVG	75.3	110	140	3.5	0.5
7314 JVG	81	125	150	3.5	0.5
7315 JVG	87.2	125	160	3.5	0.5
7316 JVG	92.3	135	170	3.5	0.5
7317 JVG	97.8	144	180	4	0.5
7318 JVG	106	150	190	4	0.5
7319 JVG	110.5	160	200	4	0.5
7320 JVG	116	170	215	4	0.5
7321 JVG	121	180	225	4	0.5
7322 JVG	126	195	240	4	0.5

Series 73 side H

7300	10	35	11
7301	12	37	12
7302	15	42	13
7303	17	47	14
7304	20	52	15
7305	25	62	17
7306	30	72	19
7307	35	80	21
7308	40	90	23
7309	45	100	25
7310	50	110	27
7311	55	120	29
7312	60	130	31
7313	65	140	33
7314	70	150	35
7315	75	160	37
7316	80	170	39
7317	85	180	41
7318	90	190	43
7319	95	200	45
7320	100	215	47
7321	105	225	49
7322	110	240	50

7300 AVH	32.7	23	10	2	0.3
7301 AVH	35.2	23	12	2	0.3
7302 AVH	39.5	27	15	2	0.3
7303 AVH	43.7	34	17	2.5	0.3
7304 AVH	48.8	35	20	2.5	0.3
7305 AVH	57.5	40	25	2.5	0.3
7306 AVH	67.8	48	30	2.5	0.3
7307 AVH	74.6	50	35	3	0.3
7308 AVH	83.5	67	40	3	0.3
7309 AVH	94.8	75	45	3	0.3
7310 AVH	103	83	50	3	0.3
7311 AVH	113.8	85	55	3	0.3
7312 AVH	122	100	60	3.5	0.5
7313 AVH	132	105	65	3.5	0.5
7314 AVH	142	117	70	3.5	0.5
7315 AVH	152	120	75	3.5	0.5
7316 AVH	162	123	80	3.5	0.5
7317 AVH	169	140	85	4	0.5
7318 AVH	180	140	90	4	0.5
7319 AVH	188	155	95	4	0.5
7320 AVH	199	165	100	4	0.5
7321 AVH	214	173	105	4	0.5
7322 AVH	229	183	110	4	0.5

7300 JVH	15.5	27	35	2	0.3
7301 JVH	17.5	29	37	2	0.3
7302 JVH	20.8	33	42	2	0.3
7303 JVH	23	36	47	2	0.3
7304 JVH	27.2	40	52	2	0.3
7305 JVH	32.2	47	62	2.5	0.3
7306 JVH	37.2	56	72	2.5	0.3
7307 JVH	45	65	80	2.5	0.3
7308 JVH	51	70	90	3	0.3
7309 JVH	56	80	100	3	0.3
7310 JVH	62	86	110	3	0.3
7311 JVH	67	93	120	3	0.3
7312 JVH	73	102	130	3	0.5
7313 JVH	77.5	110	140	3.5	0.5
7314 JVH	82.6	120	150	3.5	0.5
7315 JVH	87.2	125	160	3.5	0.5
7316 JVH	95	138	170	3.5	0.5
7317 JVH	100	140	180	4	0.5
7318 JVH	106	150	190	4	0.5
7319 JVH	115	160	200	4	0.5
7320 JVH	118	170	215	4	0.5
7321 JVH	127	180	225	4	0.5
7322 JVH	133	197	240	4	0.5

NILOS-Rings for four-point contact ball bearings

Series QJ2

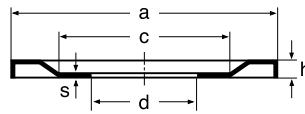
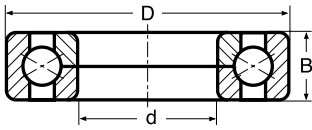

AV

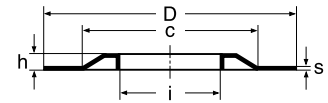

JV

Bearing	d	D	B
QJ 206	30	62	16
QJ 207	35	72	17
QJ 208	40	80	18
QJ 209	45	85	19
QJ 210	50	90	20
QJ 211	55	100	21
QJ 212	60	110	22
QJ 213	65	120	23
QJ 214	70	125	25
QJ 215	75	130	20
QJ 216	80	140	26
QJ 217	85	150	28
QJ 218	90	160	30
QJ 220	100	180	34
QJ 222	110	200	38
QJ 224	120	215	40
QJ 226	130	230	40
QJ 228	140	250	42
QJ 230	150	270	45
QJ 232	160	290	48
QJ 234	170	310	51

NILOS-Ring	a	c	d	h	s
QA 206 AV	56.2	44	30	2.5	0.3
QA 207 AV	64.8	48	35	2.5	0.3
QA 208 AV	72.7	57	40	3	0.3
QA 209 AV	77.8	61	45	3	0.3
QA 210 AV	82.8	67	50	3	0.3
QA 211 AV	90.8	75	55	3	0.3
QA 212 AV	100.8	85	60	3	0.3
QA 213 AV	110.5	90	65	3	0.3
QA 214 AV	115.8	95	70	3.5	0.3
QA 215 AV	120.5	100	75	3.5	0.5
QA 216 AV	129	106	80	3.5	0.5
QA 217 AV	138.5	115	85	3.5	0.5
QA 218 AV	148	124	90	3.5	0.5
QA 220 AV	167	135	100	4	0.5
QA 222 AV	184	150	110	4	0.5
QA 224 AV	199	165	120	4	0.5
QA 226 AV	214	173	130	4	0.5
QA 228 AV	229	183	140	4	0.5
QA 230 AV	248	200	150	4	0.5
QA 232 AV	267	220	160	5	0.5

NILOS-Ring	i	c	D	h	s
QJ 206 JV	36.3	47	62	2.5	0.3
QJ 207 JV	43	56	72	2.5	0.3
QJ 208 JV	48	62	80	3	0.3
QJ 209 JV	53	68	85	3	0.3
QJ 210 JV	57.5	73	90	3	0.3
QJ 211 JV	64.5	80	100	3	0.3
QJ 212 JV	70	85	110	3	0.3
QJ 213 JV	74.5	95	120	3	0.3
QJ 214 JV	79.5	102	125	3.5	0.3
QJ 215 JV	85	105	130	3.5	0.5
QJ 216 JV	92	112	140	3.5	0.5
QJ 217 JV	98	125	150	3.5	0.5
QJ 218 JV	103	125	160	3.5	0.5
QJ 220 JV	115	145	180	4	0.5
QJ 222 JV	125.5	165	200	4	0.5
QJ 224 JV	134	175	215	4	0.5
QJ 226 JV	147	190	230	4	0.5
QJ 228 JV	160	200	250	4	0.5
QJ 230 JV	172	220	270	4	0.5
QJ 232 JV	184	240	290	5	0.5
QJ 234 JV	200	261	310	5	0.5

NILOS-Rings for double row angular contact ball bearings

Series 32
Series 33

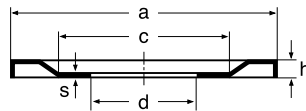
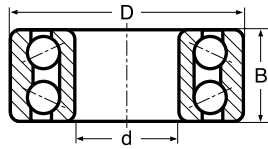

AV

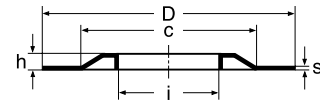

JV

Bearing	d	D	B
3200	10	30	14
3201	12	32	15.9
3202	15	35	15.9
3203	17	40	17.5
3204	20	47	20.6
3205	25	52	20.6
3206	30	62	23.8
3207	35	72	27
3208	40	80	30.2
3209	45	85	30.2
3210	50	90	30.2
3211	55	100	33.3
3212	60	110	36.5
3213	65	120	38.1
3214	70	125	39.7
3215	75	130	41.3
3216	80	140	44.4
3217	85	150	49.2
3218	90	160	52.4
3219	95	170	55.6
3220	100	180	60.3
3221	105	190	65.1
3222	110	200	69.8

NILOS-Ring	a	c	d	h	s
3200 AV	27.5	18	10	1.8	0.3
3201 AV	30	20	12	1.8	0.3
3202 AV	32.8	22	15	2	0.3
3203 AV	36.8	26	17	2	0.3
3204 AV	43.7	34	20	2.5	0.3
3205 AV	48.8	35	25	2.5	0.3
3206 AV	58.8	44	30	2.5	0.3
3207 AV	67.8	48	35	2.5	0.3
3208 AV	75.8	54	40	3	0.3
3209 AV	80.5	60	45	3	0.3
3210 AV	85.8	64	50	3	0.3
3211 AV	94.8	75	55	3	0.3
3212 AV	104.8	85	60	3	0.3
3213 AV	114.8	88	65	3	0.3
3214 AV	119.8	90	70	3.5	0.3
3215 AV	124.8	94	75	3.5	0.5
3216 AV	133.5	100	80	3.5	0.5
3217 AV	143.5	110	85	3.5	0.5
3218 AV	153.5	115	90	3.5	0.5
3219 AV	162	123	95	3.5	0.5
3220 AV	172	130	100	4	0.5
3221 AV	183	135	105	4	0.5
3222 AV	192	155	110	4	0.5

NILOS-Ring	i	c	D	h	s
3200 JV	14.4	24	30	1.8	0.3
3201 JV	16.4	26	32	1.8	0.3
3202 JV	18.6	27	35	2	0.3
3203 JV	21.5	31	40	2	0.3
3204 JV	25.7	37	47	2	0.3
3205 JV	31.5	42	52	2.5	0.3
3206 JV	36.3	47	62	2.5	0.3
3207 JV	43	56	72	2.5	0.3
3208 JV	48	62	80	3	0.3
3209 JV	53	68	85	3	0.3
3210 JV	57.5	73	90	3	0.3
3211 JV	64.5	80	100	3	0.3
3212 JV	70	85	110	3	0.3
3213 JV	74.5	95	120	3	0.3
3214 JV	79.5	102	125	3.5	0.3
3215 JV	85	105	130	3.5	0.5
3216 JV	92	112	140	3.5	0.5
3217 JV	98	125	150	3.5	0.5
3218 JV	103	125	160	3.5	0.5
3219 JV	110	137	170	3.5	0.5
3220 JV	115	145	180	4	0.5
3221 JV	119.5	158	190	4	0.5
3222 JV	125.5	165	200	4	0.5

3302	15	42	19
3303	17	47	22.2
3304	20	52	22.2
3305	25	62	25.4
3306	30	72	30.2
3307	35	80	34.9
3308	40	90	36.5
3309	45	100	39.7
3310	50	110	44.4
3311	55	120	49.2
3312	60	130	54
3313	65	140	58.7
3314	70	150	63.5
3315	75	160	68.3
3316	80	170	68.3
3317	85	180	73
3318	90	190	73
3319	95	200	77.8
3320	100	215	82.6
3321	105	225	87.3
3322	110	240	92.1

3302 AV	38.8	25	15	2	0.3
3303 AV	43.7	34	17	2.5	0.3
3304 AV	47.8	35	20	2.5	0.3
3305 AV	57.5	40	25	2.5	0.3
3306 AV	67.8	48	30	2.5	0.3
3307 AV	74.8	50	35	2.5	0.3
3308 AV	83.8	56	40	3	0.3
3309 AV	94.8	75	45	3	0.3
3310 AV	103	83	50	3	0.3
3311 AV	113.8	85	55	3	0.3
3312 AV	122	100	60	3.5	0.5
3313 AV	132	105	65	3.5	0.5
3314 AV	142	117	70	3.5	0.5
3315 AV	152	120	75	3.5	0.5
3316 AV	162	123	80	3.5	0.5
3317 AV	169	140	85	4	0.5
3318 AV	180	140	90	4	0.5
3319 AV	188	155	95	4	0.5
3320 AV	205	160	100	4	0.5
3321 AV	214	173	105	4	0.5
3322 AV	229	183	110	4	0.5

3302 JV	20.8	33	42	2	0.3
3303 JV	23	36	47	2	0.3
3304 JV	27.2	40	52	2	0.3
3305 JV	32.2	47	62	2.5	0.3
3306 JV	37.2	56	72	2.5	0.3
3307 JV	45	65	80	2.5	0.3
3308 JV	51	70	90	3	0.3
3309 JV	56	80	100	3	0.3
3310 JV	62	86	110	3	0.3
3311 JV	67	93	120	3	0.3
3312 JV	73	102	130	3	0.5
3313 JV	77.5	110	140	3.5	0.5
3314 JV	82.6	120	150	3.5	0.5
3315 JV	87.2	125	160	3.5	0.5
3316 JV	95	138	170	3.5	0.5
3317 JV	100	140	180	4	0.5
3318 JV	106	150	190	4	0.5
3319 JV	115	160	200	4	0.5
3320 JV	118	170	215	4	0.5
3321 JV	127	180	225	4	0.5
3322 JV	133	197	240	4	0.5

NILOS-Rings for single row magneto bearings

Series B0, E, L side G
Series B0, E, L side H

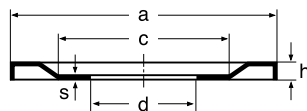
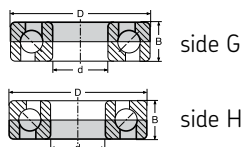

AVG or AVH

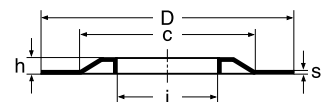

JVG or JVH

Bearing	d	D	B
---------	---	---	---

Series B0, E, L side G

E 3	3	16	5
E 4	4	16	5
E 5	5	16	5
E 6	6	21	7
E 7	7	22	7
E 8	8	24	7
E 9	9	28	8
E 10	10	28	8
E 11	11	32	7
E 12	12	32	7
E 13	13	30	7
E 15	15	35	8
B0 15	15	40	10
B0 17	17	44	11
E 19	19	40	9
E 20	20	47	12
L 17	17	40	10
L 20	20	47	14
L 25	25	52	15
L 30	30	62	16

NILOS-Ring	a	c	d	h	s
------------	---	---	---	---	---

E 3 AVG	14.8	10	3	1.5	0.3
E 4 AVG	14.8	10	4	1.5	0.3
E 5 AVG	14.8	10	5	1.5	0.3
E 6 AVG	18.8	12	6	1.8	0.3
E 7 AVG	20	13	7	1.8	0.3
E 8 AVG	22	16	8	1.8	0.3
E 9 AVG	25.2	17	9	1.8	0.3
E 10 AVG	25.2	17	10	1.8	0.3
E 11 AVG	30	20	11	1.8	0.3
E 12 AVG	28.1	20	12	1.8	0.3
E 13 AVG	28.1	20	13	1.8	0.3
E 15 AVG	31.8	22	15	2	0.3
B0 15 AVG	36.5	26	15	2	0.3
B0 17 AVG	39.5	27	17	2	0.3
E 19 AVG	35.7	25	19	2	0.3
E 20 AVG	41.2	29	20	2	0.3
L 17 AVG	35.7	25	17	2	0.3
L 20 AVG	41.2	29	20	2	0.3
L 25 AVG	46.5	37	25	2.5	0.3
L 30 AVG	46.5	44	30	2.5	0.3

NILOS-Ring	i	c	D	h	s
------------	---	---	---	---	---

E 3 JVG	6.2	13	16	1.5	0.3
E 4 JVG	6.2	13	16	1.5	0.3
E 5 JVG	6.2	13	16	1.5	0.3
E 6 JVG	8.2	16	21	1.8	0.3
E 7 JVG	9.3	17	22	1.8	0.3
E 8 JVG	10.4	19	24	1.8	0.3
E 9 JVG	13	23	28	1.8	0.3
E 10 JVG	13	23	28	1.8	0.3
E 11 JVG	15.5	25	32	1.8	0.3
E 12 JVG	15.5	25	32	1.8	0.3
E 13 JVG	15	24	30	1.8	0.3
E 15 JVG	18.6	27	35	2	0.3
B0 15 JVG	19.5	30	40	2	0.3
B0 17 JVG	21.5	34	44	2	0.3
E 19 JVG	21.5	31	40	2	0.3
E 20 JVG	24	37	47	2	0.3
L 17 JVG	21.5	31	40	2	0.3
L 20 JVG	25.7	37	47	2	0.3
L 25 JVG	31.5	42	52	2.5	0.3
L 30 JVG	36.3	47	62	2.5	0.3

Series B0, E, L side H

E 3	3	16	5
E 4	4	16	5
E 5	5	16	5
E 6	6	21	7
E 7	7	22	7
E 8	8	24	7
E 9	9	28	8
E 10	10	28	8
E 11	11	32	7
E 12	12	32	7
E 13	13	30	7
E 15	15	35	8
B0 15	15	40	10
B0 17	17	44	11
E 19	19	40	9
E 20	20	47	12
L 17	17	40	10
L 20	20	47	14
L 25	25	52	15
L 30	30	62	16

E 3 AVH	14.8	10	3	1.5	0.3
E 4 AVH	14.8	10	4	1.5	0.3
E 5 AVH	14.8	10	5	1.5	0.3
E 6 AVH	20	13	6	1.8	0.3
E 7 AVH	21.4	12	7	1.8	0.3
E 8 AVH	23	17	8	1.8	0.3
E 9 AVH	26.8	20	9	1.8	0.3
E 10 AVH	26.8	20	10	1.8	0.3
E 11 AVH	30	20	11	1.8	0.3
E 12 AVH	30	20	12	1.8	0.3
E 13 AVH	29	20	13	1.8	0.3
E 15 AVH	33.8	23	15	2	0.3
B0 15 AVH	38	28	15	2	0.3
B0 17 AVH	41.2	29	17	2	0.3
E 19 AVH	36.5	26	19	2	0.3
E 20 AVH	44.8	33	20	2	0.3
L 17 AVH	38	28	17	2	0.3
L 20 AVH	44.8	33	20	2	0.3
L 25 AVH	50	40	25	2.5	0.3
L 30 AVH	56.2	44	25	2.5	0.3

E 3 JVH	6.2	13	16	1.5	0.3
E 4 JVH	6.2	13	16	1.5	0.3
E 5 JVH	6.2	13	16	1.5	0.3
E 6 JVH	8.2	16	21	1.8	0.3
E 7 JVH	9.3	17	22	1.8	0.3
E 8 JVH	10.4	19	24	1.8	0.3
E 9 JVH	13	23	28	1.8	0.3
E 10 JVH	13	23	28	1.8	0.3
E 11 JVH	15.5	25	32	1.8	0.3
E 12 JVH	15.5	25	32	1.8	0.3
E 13 JVH	15	24	30	1.8	0.3
E 15 JVH	18.6	27	35	2	0.3
B0 15 JVH	19.5	30	40	2	0.3
B0 17 JVH	21.5	34	44	2	0.3
E 19 JVH	21.5	31	40	2	0.3
E 20 JVH	24	37	47	2	0.3
L 17 JVH	21.5	31	40	2	0.3
L 20 JVH	25.7	37	47	2	0.3
L 25 JVH	31.5	42	52	2.5	0.3
L 30 JVH	36.3	47	62	2.5	0.3

NILOS-Rings for single row cylindrical roller bearings

Series NUP 2
Series NUP 3

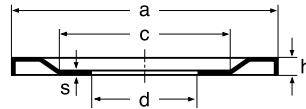
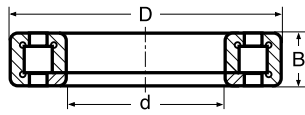

AV

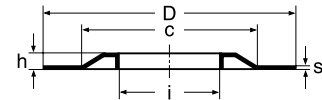

JV

Bearing	d	D	B	NILOS-Ring	a	c	d	h	s	NILOS-Ring	i	c	D	h	s
NUP 203	17	40	12	NUP 203 AV	35.7	25	17	2	0.3	NUP 203 JV	21.5	31	40	2	0.3
NUP 204	20	47	14	NUP 204 AV	41.2	29	20	2	0.3	NUP 204 JV	25.7	37	47	2	0.3
NUP 205	25	52	15	NUP 205 AV	47	36	25	2.5	0.3	NUP 205 JV	31.5	42	52	2.5	0.3
NUP 206	30	62	16	NUP 206 AV	56.2	44	30	2.5	0.3	NUP 206 JV	36.3	47	62	2.5	0.3
NUP 207	35	72	17	NUP 207 AV	64.8	48	35	2.5	0.3	NUP 207 JV	43	56	72	2.5	0.3
NUP 208	40	80	18	NUP 208 AV	72.7	57	40	3	0.3	NUP 208 JV	48	62	80	3	0.3
NUP 209	45	85	19	NUP 209 AV	77.8	61	45	3	0.3	NUP 209 JV	53	68	85	3	0.3
NUP 210	50	90	20	NUP 210 AV	82.8	67	50	3	0.3	NUP 210 JV	57.5	73	90	3	0.3
NUP 211	55	100	21	NUP 211 AV	90.8	75	55	3	0.3	NUP 211 JV	64.5	80	100	3	0.3
NUP 212	60	110	22	NUP 212 AV	100.8	85	60	3	0.3	NUP 212 JV	70	85	110	3	0.3
NUP 213	65	120	23	NUP 213 AV	110.5	90	65	3	0.3	NUP 213 JV	74.5	95	120	3	0.3
NUP 214	70	125	24	NUP 214 AV	115.8	95	70	3.5	0.3	NUP 214 JV	79.5	102	125	3.5	0.3
NUP 215	75	130	25	NUP 215 AV	120.5	100	75	3.5	0.5	NUP 215 JV	85	105	130	3.5	0.5
NUP 216	80	140	26	NUP 216 AV	129	106	80	3.5	0.5	NUP 216 JV	92	112	140	3.5	0.5
NUP 217	85	150	28	NUP 217 AV	138.5	115	85	3.5	0.5	NUP 217 JV	98	125	150	3.5	0.5
NUP 218	90	160	30	NUP 218 AV	148	124	90	3.5	0.5	NUP 218 JV	103	125	160	3.5	0.5
NUP 219	95	170	32	NUP 219 AV	157.5	130	95	3.5	0.5	NUP 219 JV	110	137	170	3.5	0.5
NUP 220	100	180	34	NUP 220 AV	167	135	100	4	0.5	NUP 220 JV	115	145	180	4	0.5
NUP 221	105	190	36	NUP 221 AV	174	140	105	4	0.5	NUP 221 JV	119.5	158	190	4	0.5
NUP 222	110	200	38	NUP 222 AV	184	150	110	4	0.5	NUP 222 JV	125.5	165	200	4	0.5
NUP 224	120	215	40	NUP 224 AV	199	165	120	4	0.5	NUP 224 JV	134	175	215	4	0.5
NUP 226	130	230	40	NUP 226 AV	214	173	130	4	0.5	NUP 226 JV	147	190	230	4	0.5
NUP 228	140	250	42	NUP 228 AV	229	183	140	4	0.5	NUP 228 JV	160	200	250	4	0.5
NUP 230	150	270	45	NUP 230 AV	248	200	150	4	0.5	NUP 230 JV	172	220	270	4	0.5
NUP 232	160	290	48	NUP 232 AV	267	220	160	5	0.5	NUP 232 JV	184	240	290	5	0.5
NUP 234	170	310	52	NUP 234 AV	286	235	170	5	0.5	NUP 234 JV	200	261	310	5	0.5
NUP 236	180	320	52	NUP 236 AV	295	237	180	5	0.5	NUP 236 JV	205	265	320	5	0.5
NUP 238	190	340	55	NUP 238 AV	314	260	190	5	0.5	NUP 238 JV	212	285	340	5	0.5
NUP 240	200	360	58	NUP 240 AV	335	280	200	5	0.5	NUP 240 JV	220	305	360	5	0.5
NUP 304	20	52	15	NUP 304 AV	44.8	33	20	2	0.3	NUP 304 JV	27.2	40	52	2	0.3
NUP 305	25	62	17	NUP 305 AV	54.8	40	25	2.5	0.3	NUP 305 JV	32.2	47	62	2.5	0.3
NUP 306	30	72	19	NUP 306 AV	64.8	48	30	2.5	0.3	NUP 306 JV	37.2	56	72	2.5	0.3
NUP 307	35	80	21	NUP 307 AV	70.7	54	35	2.5	0.3	NUP 307 JV	45	65	80	2.5	0.3
NUP 308	40	90	23	NUP 308 AV	80.5	60	40	3	0.3	NUP 308 JV	51	70	90	3	0.3
NUP 309	45	100	25	NUP 309 AV	90.8	75	45	3	0.3	NUP 309 JV	56	80	100	3	0.3
NUP 310	50	110	27	NUP 310 AV	98.9	80	50	3	0.3	NUP 310 JV	62	86	110	3	0.3
NUP 311	55	120	29	NUP 311 AV	108	89	55	3	0.3	NUP 311 JV	67	93	120	3	0.3
NUP 312	60	130	31	NUP 312 AV	117.5	95	60	3.5	0.3	NUP 312 JV	73	102	130	3	0.5
NUP 313	65	140	33	NUP 313 AV	127.5	100	65	3.5	0.3	NUP 313 JV	77.5	110	140	3.5	0.5
NUP 314	70	150	35	NUP 314 AV	137	110	70	3.5	0.5	NUP 314 JV	82.6	120	150	3.5	0.5
NUP 315	75	160	37	NUP 315 AV	147	110	75	3.5	0.5	NUP 315 JV	87.2	125	160	3.5	0.5
NUP 316	80	170	39	NUP 316 AV	157.5	130	80	4	0.5	NUP 316 JV	95	138	170	3.5	0.5
NUP 317	85	180	41	NUP 317 AV	164	135	85	4	0.5	NUP 317 JV	100	14	180	4	0.5
NUP 318	90	190	43	NUP 318 AV	174	140	90	4	0.5	NUP 318 JV	106	150	190	4	0.5
NUP 319	95	200	45	NUP 319 AV	184	150	95	4	0.5	NUP 319 JV	115	160	200	4	0.5
NUP 320	100	215	47	NUP 320 AV	199	165	100	4	0.5	NUP 320 JV	118	170	215	4	0.5
NUP 321	105	225	49	NUP 321 AV	208	174	105	4	0.5	NUP 321 JV	127	180	225	4	0.5
NUP 322	110	240	50	NUP 322 AV	219	179	110	4	0.5	NUP 322 JV	133	197	240	4	0.5
NUP 324	120	260	55	NUP 324 AV	239	190	120	5	0.5	NUP 324 JV	142	205	260	4	0.5
NUP 326	130	280	58	NUP 326 AV	251	200	130	5	0.5	NUP 326 JV	148	225	280	5	0.5
NUP 328	140	300	62	NUP 328 AV	267	220	140	5	0.5	NUP 328 JV	165	235	300	5	0.5
NUP 330	150	320	65	NUP 330 AV	286	235	150	5	0.5	NUP 330 JV	172	255	320	5	0.5
NUP 332	160	340	68	NUP 332 AV	314	260	160	5	0.5	NUP 332 JV	185	276	340	5	0.5
NUP 334	170	360	72	NUP 334 AV	320	268	170	5	0.5	NUP 334 JV	200	295	360	5	0.5

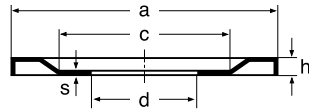
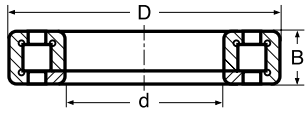

AV

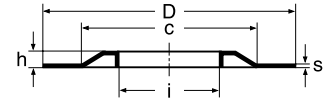

JV

Bearing	d	D	B
NUP 406	30	90	23
NUP 407	35	100	25
NUP 408	40	110	27
NUP 409	45	120	29
NUP 410	50	130	31
NUP 411	55	140	33
NUP 412	60	150	35
NUP 413	65	160	37
NUP 414	70	180	42
NUP 415	75	190	45
NUP 416	80	200	48
NUP 417	85	210	52
NUP 418	90	215	54
NUP 419	95	240	55
NUP 420	100	250	58
NUP 421	105	260	60
NUP 422	110	280	65
NUP 424	120	310	72
NUP 426	130	340	78
NUP 428	140	360	82

NILOS-Ring	a	c	d	h	s
NUP 406 AV	77.8	61	30	3	0.3
NUP 407 AV	88	71	35	3	0.3
NUP 408 AV	94.8	75	40	3	0.3
NUP 409 AV	105.8	85	45	3	0.3
NUP 410 AV	115.8	95	50	3.5	0.3
NUP 411 AV	125.8	95	55	3.5	0.5
NUP 412 AV	133.5	100	60	3.5	0.5
NUP 413 AV	143.5	110	65	3.5	0.5
NUP 414 AV	157.5	130	70	3.5	0.5
NUP 415 AV	169	140	75	4	0.5
NUP 416 AV	180	140	80	4	0.5
NUP 417 AV	188	155	85	4	0.5
NUP 418 AV	199	165	90	4	0.5
NUP 419 AV	214	173	95	4	0.5
NUP 420 AV	229	183	100	4	0.5
NUP 421 AV	239	190	105	4	0.5
NUP 422 AV	248	200	110	4	0.5
NUP 424 AV	267	220	120	5	0.5
NUP 426 AV	314	260	130	5	0.5
NUP 428 AV	320	268	140	5	0.5

NILOS-Ring	i	c	D	h	s
NUP 406 JV	42	68	90	3	0.3
NUP 407 JV	747	77	100	3	0.3
NUP 408 JV	54	81	110	3	0.3
NUP 409 JV	58.2	94	120	3	0.3
NUP 410 JV	65	103	130	3.5	0.5
NUP 411 JV	70.5	110	140	3.5	0.5
NUP 412 JV	75.5	115	150	3.5	0.5
NUP 413 JV	81	125	160	3.5	0.5
NUP 414 JV	89	131	180	3.5	0.5
NUP 415 JV	93	141	190	4	0.5
NUP 416 JV	100	150	200	4	0.5
NUP 417 JV	106	155	210	4	0.5
NUP 418 JV	112.5	165	225	4	0.5

NUP 2205	25	52	18
NUP 2206	30	62	20
NUP 2207	35	72	23
NUP 2208	40	80	23
NUP 2209	45	85	23
NUP 2210	50	90	23
NUP 2211	55	100	25
NUP 2212	60	110	28
NUP 2213	65	120	31
NUP 2214	70	125	31
NUP 2215	75	130	31
NUP 2216	80	140	33
NUP 2217	85	150	36
NUP 2218	90	160	40
NUP 2219	95	170	43
NUP 2220	100	180	46
NUP 2222	110	200	53
NUP 2224	120	215	58
NUP 2226	130	230	64
NUP 2228	140	250	68
NUP 2230	150	270	73

NUP 2205 AV	47	36	25	2.5	0.3
NUP 2206 AV	56.2	44	30	2.5	0.3
NUP 2207 AV	64.8	48	35	2.5	0.3
NUP 2208 AV	72.7	57	40	3	0.3
NUP 2209 AV	77.8	61	45	3	0.3
NUP 2210 AV	82.8	67	50	3	0.3
NUP 2211 AV	90.8	75	55	3	0.3
NUP 2212 AV	100.8	85	60	3	0.3
NUP 2213 AV	110.5	90	65	3	0.3
NUP 2214 AV	115.8	95	70	3.5	0.3
NUP 2215 AV	120.5	100	75	3.5	0.5
NUP 2216 AV	129	106	80	3.5	0.5
NUP 2217 AV	138.5	115	85	3.5	0.5
NUP 2218 AV	148	124	90	3.5	0.5
NUP 2219 AV	157.5	130	95	3.5	0.5
NUP 2220 AV	167	135	100	4	0.5
NUP 2222 AV	184	150	110	4	0.5
NUP 2224 AV	199	165	120	4	0.5
NUP 2226 AV	214	173	130	4	0.5
NUP 2228 AV	229	183	140	4	0.5
NUP 2230 AV	248	200	150	4	0.5

NUP 2205 JV	31.5	42	52	2.5	0.3
NUP 2206 JV	36.3	47	62	2.5	0.3
NUP 2207 JV	43	56	72	2.5	0.3
NUP 2208 JV	48	62	80	3	0.3
NUP 2209 JV	53	68	85	3	0.3
NUP 2210 JV	57.5	73	90	3	0.3
NUP 2211 JV	64.5	80	100	3	0.3
NUP 2212 JV	70	85	110	3	0.3
NUP 2213 JV	74.5	95	120	3	0.3
NUP 2214 JV	79.5	102	125	3.5	0.3
NUP 2215 JV	85	105	130	3.5	0.5
NUP 2216 JV	92	112	140	3.5	0.5
NUP 2217 JV	98	125	150	3.5	0.5
NUP 2218 JV	103	125	160	3.5	0.5
NUP 2219 JV	110	137	170	3.5	0.5
NUP 2220 JV	115	145	180	4	0.5
NUP 2222 JV	125.5	165	200	4	0.5
NUP 2224 JV	134	175	215	4	0.5
NUP 2226 JV	147	190	230	4	0.5
NUP 2228 JV	160	200	250	4	0.5
NUP 2230 JV	172	220	270	4	0.5

NILOS-Rings for single row cylindrical roller bearings

Series NUP 23

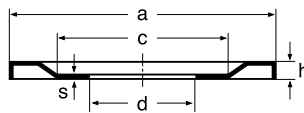
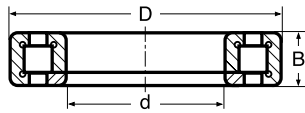

AV

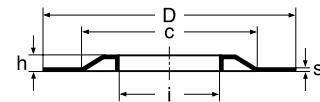

JV

Bearing	d	D	B
NUP 2305	25	62	24
NUP 2306	30	72	27
NUP 2307	35	80	31
NUP 2308	40	90	33
NUP 2309	45	100	36
NUP 2310	50	110	40
NUP 2311	55	120	43
NUP 2312	60	130	46
NUP 2313	65	140	48
NUP 2314	70	150	51
NUP 2315	75	160	55
NUP 2316	80	170	58
NUP 2317	85	180	60
NUP 2318	90	190	64
NUP 2319	95	200	67
NUP 2320	100	215	73
NUP 2322	110	240	80
NUP 2324	120	260	86
NUP 2326	130	280	93
NUP 2328	140	300	102
NUP 2330	150	320	108
NUP 2332	160	340	114
NUP 2334	170	360	120

NILOS-Ring	a	c	d	h	s
NUP 2305 AV	54.8	40	25	2.5	0.3
NUP 2306 AV	64.8	48	30	2.5	0.3
NUP 2307 AV	70.7	54	35	2.5	0.3
NUP 2308 AV	80.5	60	40	3	0.3
NUP 2309 AV	90.8	75	45	3	0.3
NUP 2310 AV	98.9	80	50	3	0.3
NUP 2311 AV	108	89	55	3	0.3
NUP 2312 AV	117.5	95	60	3	0.3
NUP 2313 AV	127.5	100	65	3.5	0.3
NUP 2314 AV	137	110	70	3.5	0.5
NUP 2315 AV	147	110	75	3.5	0.5
NUP 2316 AV	157.5	130	80	3.5	0.5
NUP 2317 AV	164	135	85	4	0.5
NUP 2318 AV	174	140	90	4	0.5
NUP 2319 AV	184	150	95	4	0.5
NUP 2320 AV	199	165	100	4	0.5
NUP 2322 AV	219	179	110	4	0.5
NUP 2324 AV	239	190	120	5	0.5
NUP 2326 AV	251	200	130	5	0.5
NUP 2328 AV	267	220	140	5	0.5
NUP 2330 AV	286	235	150	5	0.5
NUP 2332 AV	314	260	160	5	0.5
NUP 2334 AV	320	268	170	5	0.5

NILOS-Ring	i	c	D	h	s
NUP 2305 JV	32.2	47	62	2.5	0.3
NUP 2306 JV	37.2	56	72	2.5	0.3
NUP 2307 JV	45	65	80	2.5	0.3
NUP 2308 JV	51	70	90	3	0.3
NUP 2309 JV	56	80	100	3	0.3
NUP 2310 JV	62	86	110	3	0.3
NUP 2311 JV	67	93	120	3	0.3
NUP 2312 JV	73	102	130	3	0.5
NUP 2313 JV	77.5	110	140	3.5	0.5
NUP 2314 JV	82.6	120	150	3.5	0.5
NUP 2315 JV	87.2	125	160	3.5	0.5
NUP 2316 JV	95	138	170	3.5	0.5
NUP 2317 JV	100	140	180	4	0.5
NUP 2318 JV	106	150	190	4	0.5
NUP 2319 JV	115	160	200	4	0.5
NUP 2320 JV	118	170	215	4	0.5
NUP 2322 JV	133	197	240	4	0.5
NUP 2324 JV	142	205	260	4	0.5
NUP 2326 JV	148	225	280	5	0.5
NUP 2328 JV	165	235	300	5	0.5
NUP 2330 JV	172	255	320	5	0.5
NUP 2332 JV	185	276	340	5	0.5
NUP 2334 JV	200	295	360	5	0.5

NILOS-Rings for single row spherical roller bearings

Series 202
Series 203

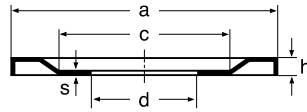
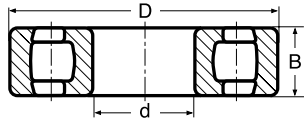

AV

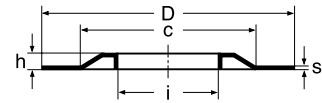

JV

Bearing	d	D	B
20205	25	52	15
20206	30	62	16
20207	35	72	17
20208	40	80	18
20209	45	85	19
20210	50	90	20
20211	55	100	21
20212	60	110	22
20213	65	120	23
20214	70	125	24
20215	75	130	25
20216	80	140	26
20217	85	150	28
20218	90	160	30
20219	95	170	32
20220	100	180	34
20221	105	190	36
20222	110	200	38
20224	120	215	40
20226	130	230	40
20228	140	250	42
20230	150	270	45
20232	160	290	48
20234	170	310	52
20236	180	320	52
20238	190	340	55
20240	200	360	58

NILOS-Ring	a	c	d	h	s
20205 AV	47	36	25	2.5	0.3
20206 AV	56.2	44	30	2.5	0.3
20207 AV	64.8	48	35	2.5	0.3
20208 AV	72.7	57	40	3	0.3
20209 AV	77.8	61	45	3	0.3
20210 AV	82.8	67	50	3	0.3
20211 AV	93.5	76	55	3	0.3
20212 AV	100.8	85	60	3	0.3
20213 AV	110.5	90	65	3	0.3
20214 AV	115.8	95	70	3.5	0.3
20215 AV	120.5	100	75	3.5	0.5
20216 AV	129	106	80	3.5	0.5
20217 AV	138.5	115	85	3.5	0.5
20218 AV	148	124	90	3.5	0.5
20219 AV	157.5	130	95	3.5	0.5
20220 AV	167	135	100	4	0.5
20221 AV	174	140	105	4	0.5
20222 AV	184	150	110	4	0.5
20224 AV	199	165	120	4	0.5
20226 AV	214	173	130	4	0.5
20228 AV	229	183	140	4	0.5
20230 AV	248	200	150	4	0.5
20232 AV	267	220	160	5	0.5
20234 AV	286	235	170	5	0.5
20236 AV	295	237	180	5	0.5
20238 AV	314	260	190	5	0.5
20240 AV	335	280	200	5	0.5

NILOS-Ring	i	c	D	h	s
20205 JV	31.5	42	52	2.5	0.3
20206 JV	36.3	47	62	2.5	0.3
20207 JV	43	56	72	2.5	0.3
20208 JV	48	62	80	3	0.3
20209 JV	53	68	85	3	0.3
20210 JV	57.5	73	90	3	0.3
20211 JV	64.5	80	100	3	0.3
20212 JV	70	85	110	3	0.3
20213 JV	74.5	95	120	3	0.3
20214 JV	79.5	102	125	3.5	0.3
20215 JV	85	105	130	3.5	0.5
20216 JV	92	112	140	3.5	0.5
20217 JV	98	125	150	3.5	0.5
20218 JV	103	125	160	3.5	0.5
20219 JV	110	137	170	3.5	0.5
20220 JV	115	145	180	4	0.5
20221 JV	119.5	158	190	4	0.5
20222 JV	125.5	165	200	4	0.5
20224 JV	134	175	215	4	0.5
20226 JV	147	190	230	4	0.5
20228 JV	160	200	250	4	0.5
20230 JV	172	220	270	4	0.5
20232 JV	184	240	290	5	0.5
20234 JV	200	261	310	5	0.5
20236 JV	205	265	320	5	0.5
20238 JV	212	285	340	5	0.5
20240 JV	220	305	360	5	0.5

20304	20	52	15
20305	25	62	17
20306	30	72	19
20307	35	80	21
20308	40	90	23
20309	45	100	25
20310	50	110	27
20311	55	120	29
20312	60	130	31
20313	65	140	33
20314	70	150	35
20315	75	160	37
20316	80	170	39
20317	85	180	41
20318	90	190	43
20319	95	200	45
20320	100	215	47
20321	105	225	49
20322	110	240	50
20324	120	260	55
20326	130	280	58
20328	140	300	62
20330	150	320	65
20332	160	340	68
20334	170	360	72

20304 AV	46.5	37	20	2	0.3
20305 AV	54.8	40	25	2.5	0.3
20306 AV	64.8	48	30	2.5	0.3
20307 AV	70.7	54	35	2.5	0.3
20308 AV	80.5	60	40	3	0.3
20309 AV	90.8	75	45	3	0.3
20310 AV	98.9	80	50	3	0.3
20311 AV	108	89	55	3	0.3
20312 AV	117.5	95	60	3	0.3
20313 AV	127.5	100	65	3.5	0.5
20314 AV	137	110	70	3.5	0.5
20315 AV	147	110	75	3.5	0.5
20316 AV	157.5	130	80	3.5	0.5
20317 AV	164	135	85	4	0.5
20318 AV	174	140	90	4	0.5
20319 AV	184	150	95	4	0.5
20320 AV	199	165	100	4	0.5
20321 AV	208	174	105	4	0.5
20322 AV	219	179	110	4	0.5
20324 AV	239	190	120	4	0.5
20326 AV	251	200	130	5	0.5
20328 AV	267	220	140	5	0.5
20330 AV	286	235	150	5	0.5
20332 AV	314	260	160	5	0.5
20334 AV	320	268	170	5	0.5

20304 JV	27.2	40	52	2	0.3
20305 JV	32.2	47	62	2.5	0.3
20306 JV	37.2	56	72	2.5	0.3
20307 JV	45	65	80	2.5	0.3
20308 JV	51	70	90	3	0.3
20309 JV	56	80	100	3	0.3
20310 JV	62	86	110	3	0.3
20311 JV	67	93	120	3	0.3
20312 JV	73	102	130	3	0.3
20313 JV	77.5	110	140	3.5	0.5
20314 JV	82.6	120	150	3.5	0.5
20315 JV	87.2	125	160	3.5	0.5
20316 JV	95	138	170	3.5	0.5
20317 JV	100	140	180	4	0.5
20318 JV	106	150	190	4	0.5
20319 JV	115	160	200	4	0.5
20320 JV	118	170	215	4	0.5
20321 JV	127	180	225	4	0.5
20322 JV	133	197	240	4	0.5
20324 JV	142	205	260	4	0.5
20326 JV	148	225	280	5	0.5
20328 JV	165	235	300	5	0.5
20330 JV	172	255	320	5	0.5
20332 JV	185	276	340	5	0.5
20334 JV	200	295	360	5	0.5

NILOS-Rings for single row spherical roller bearings

Series 204

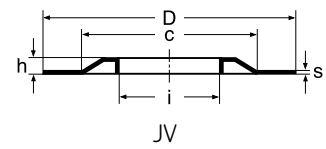
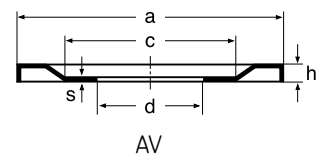
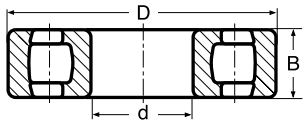

Bearing	d	D	B
20405	25	80	21
20406	30	90	23
20407	35	100	25
20408	40	110	27
20409	45	120	29
20410	50	130	31
20411	55	140	33
20412	60	150	35
20413	65	160	37
20414	70	180	42
20415	75	190	45
20416	80	200	48
20417	85	210	52
20418	90	225	54
20419	95	240	55
20420	100	250	58

NILOS-Ring	a	c	d	h	s
20405 AV	69	55	25	2.5	0.3
20406 AV	80.5	60	30	3	0.3
20407 AV	88	71	35	3	0.3
20408 AV	98.9	80	40	3	0.3
20409 AV	105.8	84	45	3	0.3
20410 AV	117.5	95	50	3	0.3
20411 AV	125.8	95	55	3.5	0.5
20412 AV	133.5	100	60	3.5	0.5
20413 AV	143.5	110	65	3.5	0.5
20414 AV	162	123	70	3.5	0.5
20415 AV	169	140	75	4	0.5
20416 AV	180	140	80	4	0.5
20417 AV	188	155	85	4	0.5
20418 AV	199	165	90	4	0.5
20419 AV	214	173	95	4	0.5
20420 AV	229	183	100	4	0.5

NILOS-Ring	i	c	D	h	s
20405 JV	36.2	62	80	2.5	0.3
20406 JV	42	68	90	3	0.3
20407 JV	47	77	100	3	0.3
20408 JV	54	81	110	3	0.3
20409 JV	58.2	94	120	3	0.3
20410 JV	65	103	130	3.5	0.5
20411 JV	70.5	110	140	3.5	0.5
20412 JV	75.5	115	150	3.5	0.5
20413 JV	81	125	160	3.5	0.5
20414 JV	89	130	180	3.5	0.5
20415 JV	93	141	190	4	0.5
20416 JV	100	150	200	4	0.5
20417 JV	106	155	210	4	0.5
20418 JV	112.5	165	225	4	0.5
20419 JV	116	175	240	4	0.5
20420 JV	121	180	250	4	0.5

NILOS-Rings for double row self-aligning roller bearings

Series 213
Series 222

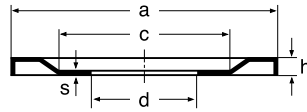
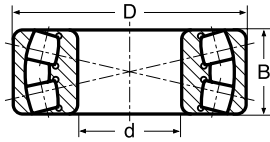

AV

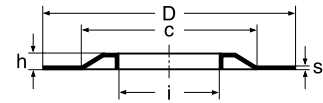

JV

Bearing	d	D	B
21304	20	52	15
21305	25	62	17
21306	30	72	19
21307	35	80	21
21308	40	90	23
21309	45	100	25
21310	50	110	27
21311	55	120	29
21312	60	130	31
21313	65	140	33
21314	70	150	35
21315	75	160	37
21316	80	170	39
21317	85	180	41
21318	90	190	43
21319	95	200	45
21320	100	215	47
21321	105	225	49
21322	110	240	50

NILOS-Ring	a	c	d	h	s
21304 AV	44.8	33	20	2	0.3
21305 AV	54.8	40	25	2.5	0.3
21306 AV	64.8	48	30	2.5	0.3
21307 AV	70.7	54	35	2.5	0.3
21308 AV	80.5	60	40	3	0.3
21309 AV	90.8	75	45	3	0.3
21310 AV	98.9	80	50	3	0.3
21311 AV	108	89	55	3	0.3
21312 AV	118	95	60	3	0.3
21313 AV	128	100	65	3.5	0.5
21314 AV	137	110	70	3.5	0.5
21315 AV	147	110	75	3.5	0.5
21316 AV	158	130	80	3.5	0.5
21317 AV	164	135	85	4	0.5
21318 AV	174	140	90	4	0.5
21319 AV	184	150	95	4	0.5
21320 AV	199	165	100	4	0.5
21321 AV	208	174	105	4	0.5
21322 AV	219	179	110	4	0.5

NILOS-Ring	i	c	D	h	s
21304 JV	27.2	40	52	2	0.3
21305 JV	32.2	47	62	2.5	0.3
21306 JV	37.2	56	72	2.5	0.3
21307 JV	45	65	80	2.5	0.3
21308 JV	51	70	90	3	0.3
21309 JV	56	80	100	3	0.3
21310 JV	62	86	110	3	0.3
21311 JV	67	93	120	3	0.3
21312 JV	73	102	130	3	0.5
21313 JV	77.5	110	140	3.5	0.5
21314 JV	82.6	120	150	3.5	0.5
21315 JV	87.2	125	160	3.5	0.5
21316 JV	95	138	170	3.5	0.5
21317 JV	100	140	180	4	0.5
21318 JV	106	150	190	4	0.5
21319 JV	115	160	200	4	0.5
21320 JV	118	170	215	4	0.5
21321 JV	127	180	225	4	0.5
21322 JV	133	197	240	4	0.5

22205	25	52	18
22206	30	62	20
22207	35	72	23
22208	40	80	23
22209	45	85	23
22210	50	90	23
22211	55	100	25
22212	60	110	28
22213	65	120	31
22214	70	125	31
22215	75	130	31
22216	80	140	33
22217	85	150	36
22218	90	160	40
22219	95	170	43
22220	100	180	46
22222	110	200	53
22224	120	215	58
22226	130	230	64
22228	140	250	68
22230	150	270	73
22232	160	290	80
22234	170	310	86
22236	180	320	86
22238	190	340	92
22240	200	360	98
22244	220	400	108
22248	240	440	120

22205 AV	47	36	25	2.5	0.3
22206 AV	56.2	44	30	2.5	0.3
22207 AV	64.8	43	35	2.5	0.3
22208 AV	72.7	57	40	3	0.3
22209 AV	77.8	61	45	3	0.3
22210 AV	82.8	67	50	3	0.3
22211 AV	90.8	75	55	3	0.3
22212 AV	101	85	60	3	0.3
22213 AV	111	90	65	3	0.3
22214 AV	116	95	70	3.5	0.3
22215 AV	121	100	75	3.5	0.5
22216 AV	129	106	80	3.5	0.5
22217 AV	139	115	85	3.5	0.5
22218 AV	148	124	90	3.5	0.5
22219 AV	157.5	130	95	3.5	0.5
22220 AV	167	135	100	4	0.5
22222 AV	184	150	110	4	0.5
22224 AV	199	165	120	4	0.5
22226 AV	214	173	130	4	0.5
22228 AV	229	183	140	4	0.5
22230 AV	248	200	150	4	0.5
22232 AV	267	220	160	5	0.5
22234 AV	286	235	170	5	0.5
22236 AV	295	237	180	5	0.5
22238 AV	314	260	190	5	0.5
22240 AV	335	280	200	5	0.5
22244 AV	369	285	220	5.8	0.7
22248 AV	390	345	240	5.3	0.7

22205 JV	28	42	52	2.5	0.3
22206 JV	36.3	47	62	2.5	0.3
22207 JV	43	56	72	2.5	0.3
22208 JV	48	62	80	3	0.3
22209 JV	53	68	85	3	0.3
22210 JV	57.5	73	90	3	0.3
22211 JV	64.5	80	100	3	0.3
22212 JV	70	85	110	3	0.3
22213 JV	74.5	95	120	3	0.3
22214 JV	79.5	102	125	3.5	0.3
22215 JV	85	105	130	3.5	0.5
22216 JV	92	112	140	3.5	0.5
22217 JV	98	125	150	3.5	0.5
22218 JV	103	125	160	3.5	0.5
22219 JV	110	137	170	3.5	0.5
22220 JV	115	145	180	4	0.5
22222 JV	125.5	165	200	4	0.5
22224 JV	134	175	215	4	0.5
22226 JV	147	190	230	4	0.5
22228 JV	160	200	250	4	0.5
22230 JV	172	220	270	4	0.5
22232 JV	184	240	290	5	0.5
22234 JV	200	261	310	5	0.5
22236 JV	205	265	320	5	0.5
22238 JV	212	285	340	5	0.5
22240 JV	220	305	360	5	0.5
22244 JV	260	380	400	7	0.7
22248 JV	260	380	440	7	0.7

For E type sphericals only, use AV style NILOS-Rings

NILOS-Rings for double row self-aligning roller bearings

Series 223
Series 230
Series 231

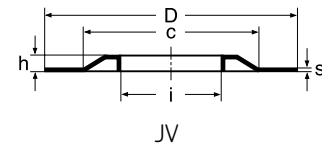
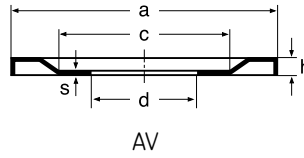
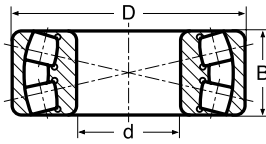

Bearing	d	D	B
22308	40	90	33
22309	45	100	36
22310	50	110	40
22311	55	120	43
22312	60	130	46
22313	65	140	48
22314	70	150	51
22315	75	160	55
22316	80	170	58
22317	85	180	60
22318	90	190	64
22319	95	200	67
22320	100	215	73
22322	110	240	80
22324	120	260	86
22326	130	280	93
22328	140	300	102
22330	150	320	108
22332	160	340	114
22334	170	360	120
22336	180	380	126
22338	190	400	132
22340	200	420	138

NILOS-Ring	a	c	d	h	s
22308 AV	80.5	60	40	3	0.3
22309 AV	90.8	75	45	3	0.3
22310 AV	98.9	80	50	3	0.3
22311 AV	108	89	55	3	0.3
22312 AV	118	95	60	3	0.3
22313 AV	127.5	100	65	3.5	0.5
22314 AV	137	110	70	3.5	0.5
22315 AV	147	110	75	3.5	0.5
22316 AV	158	130	80	3.5	0.5
22317 AV	164	135	85	4	0.5
22318 AV	174	140	90	4	0.5
22319 AV	184	150	95	4	0.5
22320 AV	199	165	100	4	0.5
22322 AV	219	179	110	4	0.5
22324 AV	239	190	120	4	0.5
22326 AV	251	200	130	5	0.5
22328 AV	267	220	140	5	0.5
22330 AV	286	235	150	5	0.5
22332 AV	314	260	160	5	0.5
22334 AV	320	268	170	5	0.5
22336 AV	335	280	180	5	0.5
22338 AV	369	285	190	5.8	0.7
22340 AV	369	285	200	5.8	0.7

NILOS-Ring	i	c	D	h	s
22308 JV	47.5	70	90	3	0.3
22309 JV	56	80	100	3	0.3
22310 JV	62	86	110	3	0.3
22311 JV	67	93	120	3	0.3
22312 JV	73	102	130	3	0.5
22313 JV	77.5	110	140	3.5	0.5
22314 JV	82.6	120	150	3.5	0.5
22315 JV	87.2	125	160	3.5	0.5
22316 JV	95	138	170	3.5	0.5
22317 JV	100	140	180	4	0.5
22318 JV	106	150	190	4	0.5
22319 JV	115	160	200	4	0.5
22320 JV	118	170	215	4	0.5
22322 JV	133	197	240	4	0.5
22324 JV	142	205	260	4	0.5
22326 JV	148	225	280	5	0.5
22328 JV	165	235	300	5	0.5
22330 JV	172	255	320	5	0.5
22332 JV	185	276	340	5	0.5
22334 JV	200	295	360	5	0.5
22336 JV	222	330	380	6.5	0.7
22338 JV	222	330	400	6.5	0.7
22340 JV	260	380	420	7	0.7

23022	110	170	45
23024	120	180	46
23026	130	200	52
23028	140	210	53
23030	150	225	56
23032	160	240	60
23034	170	260	67
23036	180	280	74
23038	190	290	75
23040	200	310	82
23044	220	340	90
23048	240	360	92
23052	260	400	104
23056	280	420	106
23060	300	460	118

23022 AV	158	124	110	4	0.5
23024 AV	169	140	120	4	0.5
23026 AV	188	155	130	4	0.5
23028 AV	199	165	140	4	0.5
23030 AV	214	173	150	4	0.5
23032 AV	229	183	160	4	0.5
23034 AV	248	200	170	4	0.5
23036 AV	267	220	180	5	0.5
23038 AV	275	220	190	5	0.5
23040 AV	286	235	200	5	0.5
23044 AV	314	260	220	5	0.5
23048 AV	335	280	240	5	0.5
23052 AV	369	285	260	5.8	0.7
23056 AV	390	345	280	5.3	0.7
23060 AV	440	388	300	8	0.7

23022 JV	120	145	170	3.5	0.5
23024 JV	128	165	180	4	0.5
23026 JV	140	170	200	4	0.5
23028 JV	152	175	210	4	0.5
23030 JV	164	185	225	4	0.5
23032 JV	174	200	240	4	0.5
23034 JV	185	215	260	4	0.5
23036 JV	200	230	280	5	0.5
23038 JV	203	243	290	5	0.5
23040 JV	220	255	310	5	0.5
23044 JV	245	285	340	5.5	0.5
23048 JV	260	315	360	6	0.5
23052 JV	290	342	400	6.2	0.7
23056 JV	310	360	420	7.7	0.7
23060 JV	330	406	460	6.7	0.7

23120	100	165	52
23122	110	180	56
23124	120	200	62
23126	130	210	64
23128	140	225	68
23130	150	250	80
23132	160	270	86
23134	170	280	88
23136	180	300	96
23138	190	320	104
23140	200	340	112
23144	220	370	120
23148	240	400	128
23152	260	440	144

23120 AV	148	124	100	3.5	0.5
23122 AV	164	135	110	4	0.5
23124 AV	184	150	120	4	0.5
23126 AV	192	155	130	4	0.5
23128 AV	208	174	140	4	0.5
23130 AV	229	183	150	4	0.5
23132 AV	248	200	160	4	0.5
23134 AV	257	215	170	4	0.5
23136 AV	267	220	180	5	0.5
23138 AV	195	237	190	5	0.5
23140 AV	314	260	200	5	0.5
23144 AV	335	280	220	5	0.5
23148 AV	369	285	240	5.8	0.7
23152 AV	390	345	260	5.3	0.7

23120 JV	111.5	137	165	3.5	0.5
23122 JV	123	165	180	4	0.5
23124 JV	134	175	200	4	0.5
23126 JV	144	190	210	4	0.5
23128 JV	155	200	225	4	0.5
23130 JV	165	235	250	5	0.5
23132 JV	180	240	270	5	0.5
23134 JV	190	240	280	5	0.5
23136 JV	200	261	300	5	0.5
23138 JV	212	285	320	5	0.5
23140 JV	220	305	340	5	0.5

For E type sphericals only, use AV style NILOS-Rings

NILOS-Rings for single row taper roller bearings

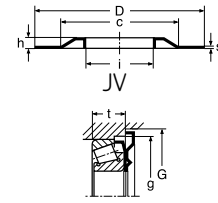
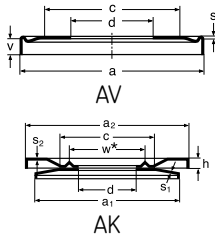
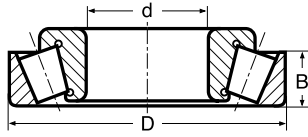

Series 320 x

Bearing	d	D	B
32004 X	20	42	12
32022 X	22	44	11.5
32005 X	25	47	11.5
32028 X	28	52	12
32006 X	30	55	13
32032 X	32	58	13
32007 X	35	62	14
32008 X	40	68	14.5
32009 X	45	75	15.5
32010 X	50	80	15.5
32011 X	55	90	17.5
32012 X	60	95	17.5
32013 X	65	100	17.5
32014 X	70	110	19
32015 X	75	115	19
32016 X	80	125	22
32017 X	85	130	22
32018 X	90	140	24
32019 X	95	145	24
32020 X	100	150	24
32021 X	105	160	26
32022 X	110	170	29
32024 X	120	180	29
32026 X	130	200	34
32028 X	140	210	34
32030 X	150	225	36
32032 X	160	240	38
32034 X	170	260	57
32036 X	180	280	64
32038 X	190	290	64
32040 X	200	310	70
32044 X	220	340	76
32048 X	240	360	76

NILOS-Ring	a	c	d	s	v
32004 XAV	40.5	33	20	0.3	3.2
32022 XAV	43	36	22	0.3	3.7
32005 XAV	46	39	25	0.3	3.7
32028 XAV	51	42	28	0.3	4.2
32006 XAV	53.8	44	30	0.3	4.2
32032 XAV	56.5	47	32	0.3	4.2
32007 XAV	60	53	35	0.3	4.2
32008 XAV	66.5	56	40	0.3	4.7
32009 XAV	73.5	63	45	0.3	4.7
32010 XAV	78.6	68	50	0.3	4.7
32011 XAV	88.4	76	55	0.3	5.7
32012 XAV	93.2	80	60	0.3	5.7
32013 XAV	98.4	86	65	0.3	5.7
32014 XAV	107.5	92	70	0.3	6.2
32015 XAV	113	98	75	0.5	6.2
32016 XAV	122.5	105	80	0.5	7.2
32017 XAV	128	110	85	0.5	7.2
32018 XAV	137	116	90	0.5	8.2
32019 XAV	142	122	95	0.5	8.2
32020 XAV	147	127	100	0.5	8.2
32021 XAV	156	133	105	0.5	9.2
32022 XAV	165.5	142	110	0.5	9.2
32024 XAV	174.5	152	120	0.5	9.2
32026 XAV	195	175	130	0.5	11.3
32028 XAV	206	180	140	0.5	11.3
32030 XAV	220	198	150	0.5	12.3
32032 XAV	235	208	160	0.5	13.3
32034 XAV	255	235	170	0.5	14.8
32036 XAV	274	235	180	0.5	16.5
32038X AV	280	255	190	0.5	16.8
32040X AV	300	260	200	0.5	17.9
32044X AV	330	290	220	0.5	19.9
32048X AV	350	310	240	0.7	19.9

NILOS-Ring	i	c	D	h	s
32004 JV	23.2	34	42	2	0.3
32022 JV	24.7	37	44	2	0.3
32005 JV	28.1	38	47	2.5	0.3
32028 JV	31.5	42	52	2.5	0.3
32006 JV	32.2	47	55	2.5	0.3
32032 JV	35	48	58	2.5	0.3
32007 JV	37	51	62	2.5	0.3
32008 JV	43	58	68	3	0.3
32009 JV	48	64	75	3	0.3
32010 JV	53	68	80	3	0.3
32011 JV	60	80	90	3	0.3
32012 JV	63	82	95	3	0.3
32013 JV	70	88	100	3.5	0.3
32014 JV	74.5	95	110	3.5	0.3
32015 JV	79.5	102	115	3.5	0.3
32016 JV	85	112	125	3.5	0.5
32017 JV	90	114	130	3.5	0.5
32018 JV	95	122	140	3.5	0.5
32019 JV	97.8	130	145	3.5	0.5
32020 JV	105	132	150	4	0.5
32021 JV	110	140	160	4	0.5
32022 JV	116	148	170	4	0.5
32024 JV	125.5	165	180	4	0.5
32026 JV	134	175	200	4	0.5
32028 JV	144	190	210	4	0.5
32030 JV	155	200	225	4	0.5
32032 JV	172	220	240	4	0.5
32034 XAV	N/A				
32036 JV	190	240	280	5	0.5
32038X AV	N/A				
32040 JV	205	265	310	5	0.5
32044X AV	N/A				
32048X AV	N/A				

Bearing	d	D	B
32004	20	42	12
32005	25	47	11.5
32006	30	55	13
32007	35	62	14
32008	40	68	14.5
32009	45	75	15.5
32010	50	80	15.5
32011	55	90	17.5
32012	60	95	17.5
32013	65	100	17.5
32014	70	110	19
32015	75	115	19
32016	80	125	22
32017	85	130	22
32018	90	140	24
32019	95	145	24
32020	100	150	24
32021	105	160	26
32022	110	170	29
32024	120	180	29
32026	130	200	34
32028	140	210	34
32030	150	225	36
32032	160	240	38

NILOS-Ring	a ₁	a ₂	c	d	w*	h	s ₁	s ₂	G	g	t
32004 XAK	40.5	45	30	20	25	3	0.3	0.5	46	42	15.4
32005 XAK	46	50	36	25	31	3	0.3	0.5	51	47	15.4
32006 XAK	53.8	58	43	30	37	3	0.3	0.5	59	55	17.4
32007 XAK	60	65	47	35	41	3	0.3	0.5	66	62	18.4
32008 XAK	66.5	71	54	40	47	4	0.3	0.5	72	68	19.4
32009 XAK	73.5	78	63	45	54	4	0.3	0.5	79	75	20.4
32010 XAK	78.6	83	64	50	57	4	0.3	0.5	84	80	20.4
32011 XAK	88.4	93	71	55	63	4	0.3	0.5	94	90	23.4
32012 XAK	93.2	98	80	60	70	4.5	0.3	0.5	99	95	23.4
32013 XAK	98.4	103	82	65	73	4.5	0.3	0.5	105	100	23.4
32014 XAK	107.5	113	91	70	80	4.5	0.3	0.5	115	110	25.4
32015 XAK	113	118	98	75	86	4.5	0.5	0.5	120	115	25.6
32016 XAK	122.5	128	103	80	91	5	0.5	0.5	130	125	29.6
32017 XAK	128	133	108	85	96	5	0.5	0.5	135	130	29.6
32018 XAK	137	143	115	90	102	5	0.5	0.5	145	140	32.6
32019 XAK	142	148	120	95	107	5	0.5	0.5	150	145	32.6
32020 XAK	147	153	124	100	112	5	0.5	0.5	155	150	32.6
32021 XAK	156	164	135	105	118	5	0.5	0.5	166	160	35.6
32022 XAK	168	174	139	110	124	5	0.5	0.5	176	170	38.6
32024 XAK	177	184	150	120	134	5	0.5	0.5	186	180	38.6
32026 XAK	195	214	173	130	150	5	0.5	0.5	217	200	45.7
32028 XAK	206	219	179	140	160	5	0.5	0.5	222	210	45.7
32030 XAK	220	239	190	150	170	5	0.5	0.5	242	225	48.7
32032 XAK	235	248	200	160	180	5	0.5	0.5	251	240	51.7

*See page 5 for mounting instructions

NILOS-Rings for single row taper roller bearings

Series 302

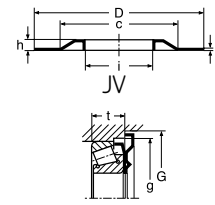
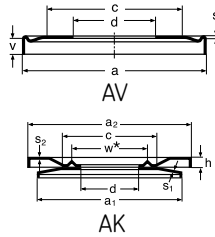
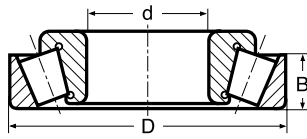

Bearing	d	D	B
30202	15	35	10
30203	17	40	11
30204	20	47	12
30205	25	52	13
30206	30	62	14
30207	35	72	15
30208	40	80	16
30209	45	85	16
30210	50	90	17
30211	55	100	18
30212	60	110	19
30213	65	120	20
30214	70	125	21
30215	75	130	22
30216	80	140	22
30217	85	150	24
30218	90	160	26
30219	95	170	27
30220	100	180	29
30221	105	190	30
30222	110	200	32
30224	120	215	34
30226	130	230	34
30228	140	250	36
30230	150	270	38
30232	160	290	40
30234	170	310	43
30236	180	320	43

NILOS-Ring	a	c	d	s	v
30202 AV	34	15	27	0.3	2.1
30203 AV	38	30	17	0.3	2.6
30204 AV	45	36	20	0.3	3.6
30205 AV	49	40	25	0.3	3.6
30206 AV	60	47	30	0.3	3.6
30207 AV	69.5	55	35	0.3	3.6
30208 AV	77.5	61	40	0.3	4.1
30209 AV	82	67	45	0.3	5.1
30210 AV	87.5	71	50	0.3	5.1
30211 AV	97	78	55	0.3	5.1
30212 AV	106.5	93	60	0.5	5.1
30213 AV	116.5	98	65	0.5	5.1
30214 AV	121	98	70	0.5	5.6
30215 AV	127	104	75	0.5	5.6
30216 AV	136	110	80	0.5	5.6
30217 AV	146	124	85	0.5	7.1
30218 AV	156	125	90	0.5	7.1
30219 AV	165	133	95	0.5	8.1
30220 AV	175	140	100	0.5	8.6
30221 AV	185	168	105	0.5	9.6
30222 AV	195	175	110	0.5	9.6
30224 AV	210	178	120	0.5	10.1
30226 AV	220	178	130	0.5	10.6
30228 AV	240	192	140	0.5	10.6
30230 AV	260	208	150	0.5	12.1
30232 AV	280	255	160	0.5	13.1
30234 AV	300	260	170	0.5	15.2
30236 AV	310	270	180	0.5	15.2

NILOS-Ring	i	c	D	h	s	v
30202 JV	17.3	27	35	2	0.3	1
30203 JV	20.2	31	40	2	0.3	1.6
30204 JV	23.6	37	47	2	0.3	1.6
30205 JV	27.2	40	52	2	0.3	1.6
30206 JV	33	49	62	2.5	0.3	1.6
30207 JV	41.9	56	72	3	0.3	1.6
30208 JV	45	65	80	2.5	0.3	2.1
30209 JV	49.4	68	85	3	0.3	2.1
30210 JV	53	82	90	2.5	0.3	2.1
30211 JV	85	84	100	4.6	0.5	2.1
30212 JV	67	93	110	3	0.5	2.1
30213 JV	74.5	108	120	5	0.5	2.1
30214 JV	76.5	108	125	5	0.5	2.6
30215 JV	81	105	130	3.5	0.5	2.6
30216 JV	87.2	120	140	3.5	0.5	2.6
30217 JV	92.3	127	150	3.5	0.5	3.1
30218 JV	97.8	130	160	3.5	0.5	3.1
30219 JV	103	150	170	3.5	0.5	3.1
30220 JV	109.5	160	180	4	0.5	3.6
30221 JV	115	160	190	4	0.5	3.6
30222 JV	120	170	200	4	0.5	3.6
30224 JV	130	180	215	4	0.5	4.1
30226 JV	136	215	230	4	0.5	3.75
30228 JV	148	225	250	5	0.5	3.8

Bearing	d	D	B
30203	17	40	11
30204	20	47	12
30205	25	52	13
30206	30	62	14
30207	35	72	15
30208	40	80	16
30209	45	85	16
30210	50	90	17
30211	55	100	18
30212	60	110	19
30213	65	120	20
30214	70	125	21
30215	75	130	22
30216	80	140	22
30217	85	150	24
30218	90	160	26
30219	95	170	27
30220	100	180	29
30221	105	190	30
30222	110	200	32
30224	120	215	34
30226	130	230	34
30228	140	250	36
30230	150	270	38
30234	170	310	43

NILOS-Ring	a ₁	a ₂	c	d	w*	h	s ₁	s ₂	G	g	t
30203 AK	38	43	30	17	24	3	0.3	0.5	44	41	13.8
30204 AK	45	50	36	20	27	3	0.3	0.5	51	48	15.8
30205 AK	49	55	40	25	33	3	0.3	0.5	56	53	16.8
30206 AK	60	65	47	30	38	3	0.3	0.5	66	63	17.5
30207 AK	69.5	75	55	35	45	4	0.3	0.5	76	73	18.8
30208 AK	77.5	83	61	40	50	4	0.3	0.5	84	81	20.3
30209 AK	82	88	67	45	55	4	0.3	0.5	89	86	21.3
30210 AK	87.5	93	71	50	60	4	0.3	0.5	94	91	22.3
30211 AK	97	103	78	55	68	4.5	0.3	0.5	104	101	23.3
30212 AK	106.5	113	85	60	73	4.5	0.5	0.5	114	111	24.5
30213 AK	116.5	123	93	65	78	4.5	0.5	0.5	124	121	25.5
30214 AK	121	128	98	70	83	5	0.5	0.5	129	126	27
30215 AK	127	133	104	75	88	5	0.5	0.5	134	131	28
30216 AK	136	143	110	80	95	5	0.5	0.5	144	141	29
30217 AK	146	153	117	85	100	5	0.5	0.5	154	151	31.5
30218 AK	156	163	125	90	103	5	0.5	0.5	164	161	33.5
30219 AK	165	173	113	95	115	5	0.5	0.5	174	171	35.5
30220 AK	175	183	140	100	120	5	0.5	0.5	184	181	38
30221 AK	185	193	148	105	125	5	0.5	0.5	194	191	40
30222 AK	195	203	156	110	135	5	0.5	0.5	204	201	42
30224 AK	210	218	165	120	145	5	0.5	0.5	219	216	44.5
30226 AK	220	233	178	130	160	5	0.5	0.5	234	231	45
30228 AK	240	253	192	140	170	5	0.5	0.5	254	251	47
30230 AK	260	273	208	150	180	5	0.5	0.5	274	271	50.5
30234 AK	300	314	260	170	205	5	0.5	0.5	315	311	58.6

*See page 5 for mounting instructions

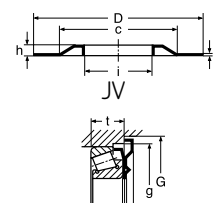
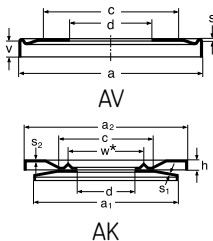
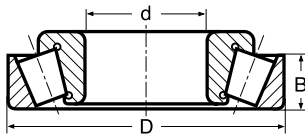

Bearing	d	D	B
33005	25	47	14
33006	30	55	16
33007	35	62	17
33008	40	68	18
33009	45	75	19
33010	50	80	19
33011	55	90	21
33012	60	95	21
33013	65	100	21
33014	70	110	25.5
33015	75	115	25.5
33016	80	125	29.5
33017	85	130	29.5
33018	90	140	32.5
33019	95	145	32.5
33020	100	150	32.5
33021	105	160	34
33022	110	170	37
33024	120	180	38
33026	130	200	43
33028	140	210	44
33030	150	225	46

NILOS-Ring	a	c	d	s	v
33005 AV	46	39	25	0.3	3.5
33006 AV	53.8	44	30	0.3	4.2
33007 AV	60	53	35	0.3	4.2
33008 AV	66.5	56	40	0.3	4.5
33009 AV	73.5	63	45	0.3	5.5
33010 AV	78.6	68	50	0.3	5.2
33011 AV	88.4	76	55	0.3	6.5
33012 AV	93.2	80	60	0.3	6.5
33013 AV	98.4	86	65	0.3	6.2
33014 AV	107.5	92	70	0.3	5.7
33015 AV	113	98	75	0.5	5.7
33016 AV	122.5	105	80	0.5	7
33017 AV	128	110	85	0.5	7
33018 AV	137	116	90	0.5	6.7
33019 AV	142	122	95	0.5	6.7
33020 AV	147	127	100	0.5	6.7
33021 AV	156	133	105	0.5	9.2
33022 AV	165.5	142	110	0.5	10.5
33024 AV	174.5	152	120	0.5	10.2
33026 AV	195	175	130	0.5	12
33028 AV	106	180	140	0.5	12.5
33030 AV	220	198	150	0.5	13.5

NILOS-Ring	i	c	D	h	s
33005 JV	28.1	38	47	2.5	0.3
33006 JV	32.2	47	55	2.5	0.3
33007 JV	37	51	62	2.5	0.3
33008 JV	43	58	68	3	0.3
33009 JV	48	64	75	3	0.3
33010 JV	53	68	80	3	0.3
33011 JV	60	80	90	3	0.3
33012 JV	63	82	95	3	0.3
33013 JV	70	88	100	3.5	0.3
33014 JV	74.5	95	110	3.5	0.3
33015 JV	79.5	102	115	3.5	0.3
33016 JV	85	112	125	3.5	0.5
33017 JV	90	114	130	3.5	0.5
33018 JV	95	122	140	3.5	0.5
33019 JV	97.8	130	145	3.5	0.5
33020 JV	105	132	150	4	0.5
33021 JV	110	140	160	4	0.5
33022 JV	116	148	170	4	0.5
33024 JV	125.5	165	180	4	0.5
33026 JV	134	175	200	4	0.5
33028 JV	144	190	210	4	0.5

Bearing	d	D	B
33005	25	47	14
33006	30	55	16
33007	35	62	17
33008	40	68	18
33009	45	75	19
33010	50	80	19
33011	55	90	21
33012	60	95	21
33013	65	100	21
33014	70	110	25.5
33015	75	115	25.5
33016	80	125	29.5
33017	85	130	29.5
33018	90	140	32.5
33019	95	145	32.5
33020	100	150	32.5
33021	105	160	34
33022	110	170	37
33024	120	180	38
33026	130	200	43
33028	140	210	44
33030	150	225	46

NILOS-Ring	a ₁	a ₂	c	d	w*	h	s ₁	s ₂	G	g	t
33005 AK	46	50	36	25	31	3	0.3	0.5	51	47	17.4
33006 AK	53.8	58	43	30	37	3	0.3	0.5	59	55	20.4
33007 AK	60	65	47	35	41	3	0.3	0.5	66	62	21.4
33008 AK	66.5	71	54	40	47	4	0.3	0.5	72	68	22.4
33009 AK	73.5	78	63	45	54	4	0.3	0.5	79	75	24.4
33010 AK	78.6	83	64	50	57	4	0.3	0.5	84	80	24.4
33011 AK	88.4	93	71	55	63	4	0.3	0.5	94	90	27.4
33012 AK	93.2	98	80	60	70	4.5	0.3	0.5	99	95	27.4
33013 AK	98.4	103	82	65	73	4.5	0.3	0.5	105	100	27.4
33014 AK	107.5	113	91	70	80	4.5	0.3	0.5	115	110	31.4
33015 AK	113	118	98	75	86	4.5	0.5	0.5	120	115	31.6
33016 AK	122.5	128	103	80	91	4.5	0.5	0.5	130	125	36.6
33017 AK	128	133	108	85	96	5	0.5	0.5	135	130	36.6
33018 AK	137	143	115	90	102	5	0.5	0.5	145	140	39.6
33019 AK	142	148	120	95	107	5	0.5	0.5	150	145	39.6
33020 AK	147	153	124	100	112	5	0.5	0.5	155	150	39.6
33021 AK	156	164	135	105	118	5	0.5	0.5	166	160	43.6
33022 AK	168	174	139	110	124	5	0.5	0.5	176	170	47.6
33024 AK	177	184	150	120	134	5	0.5	0.5	186	180	48.6
33026 AK	195	214	173	130	150	5	0.5	0.5	217	200	55.7
33028 AK	106	219	179	140	160	5	0.5	0.5	222	210	56.7
33030 AK	220	239	190	150	170	5	0.5	0.5	242	225	59.7

*See page 5 for mounting instructions

NILOS-Rings for single row taper roller bearings

Series 322

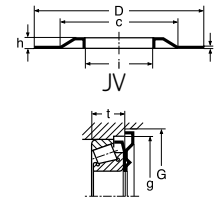
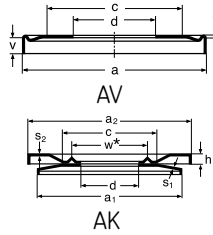
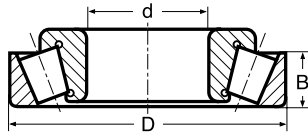

Bearing	d	D	B
32203	17	40	16
32204	20	47	15
32205	25	52	18
32206	30	62	17
32207	35	72	19
32208	40	80	19
32209	45	85	19
32210	50	90	19
32211	55	100	21
32212	60	110	24
32213	65	120	27
32214	70	125	27
32215	75	130	27
32216	80	140	28
32217	85	150	30
32218	90	160	34
32219	95	170	37
32220	100	180	39
32221	105	190	43
32222	110	200	46
32224	120	215	50
32226	130	230	54
32228	140	250	58
32230	150	270	60

NILOS-Ring	a	c	d	s	v
32203 AV	38	30	17	0.3	3.6
32204 AV	45	36	20	0.3	4.6
32205 AV	49	40	25	0.3	4.6
32206 AV	60	47	30	0.3	4.6
32207 AV	69.5	55	35	0.3	5.6
32208 AV	77.5	61	40	0.3	6.1
32209 AV	82	67	45	0.3	6.1
32210 AV	87.5	71	50	0.3	6.1
32211 AV	97	78	55	0.3	6.1
32212 AV	106.5	85	60	0.5	6.1
32213 AV	116.5	93	65	0.5	6.1
32214 AV	121	98	70	0.5	6.6
32215 AV	127	104	75	0.5	6.6
32216 AV	136	110	80	0.5	7.6
32217 AV	146	117	85	0.5	9.1
32218 AV	156	125	90	0.5	9.1
32219 AV	165	133	95	0.5	9.1
32220 AV	175	140	100	0.5	10.6
32221 AV	185	148	105	0.5	10.6
32222 AV	195	156	110	0.5	10.6
32224 AV	210	165	120	0.5	12.1
32226 AV	220	178	130	0.5	14.6
32228 AV	240	192	140	0.5	14.6
32230 AV	260	208	150	0.5	17.8

NILOS-Ring	i	c	D	h	s	v
32205 JV	27.2	40	52	2	0.3	1.6
32206 JV	33	49	62	2.5	0.3	1.6
32207 JV	41.9	56	72	3	0.3	1.6
32208 JV	45	65	80	2.5	0.3	2.1
32209 JV	49.4	68	85	3	0.3	2.1
32210 JV	53	82	90	2.5	0.3	2.1
32211 JV	85	84	100	4.6	0.5	2.1
32212 JV	67	93	110	3	0.5	2.1
32213 JV	74.5	108	120	5	0.5	2.1
32214 JV	76.5	108	125	5	0.5	2.6
32215 JV	81	105	130	3.5	0.5	2.6
32216 JV	87.2	120	140	3.5	0.5	2.6
32217 JV	92.3	127	150	3.5	0.5	3.1
32218 JV	97.8	130	160	3.5	0.5	3.1
32219 JV	103	150	170	3.5	0.5	3.1
32220 JV	109.5	160	180	4	0.5	3.6
32221 JV	115	160	190	4	0.5	3.6
32222 JV	120	170	200	4	0.5	3.6
32224 JV	130	180	215	4	0.5	4.1
32226 JV	136	215	230	4	0.5	3.75

Bearing	d	D	B
32206	30	62	17
32207	35	72	19
32208	40	80	19
32209	45	85	19
32210	50	90	19
32211	55	100	21
32212	60	110	24
32213	65	120	27
32214	70	125	27
32215	75	130	27
32216	80	140	28
32217	85	150	30
32218	90	160	34
32219	95	170	37
32220	100	180	39
32221	105	190	43
32222	110	200	46
32224	120	215	50
32226	130	230	54
32228	140	250	58
32230	150	270	60

NILOS-Ring	a ₁	a ₂	c	d	w*	h	s ₁	s ₂	G	g	t
32206 AK	60	65	47	30	38	3	0.5	0.3	66	63	21.8
32207 AK	69.5	75	55	35	45	4	0.5	0.3	76	73	24.8
32208 AK	77.5	83	61	40	50	4	0.5	0.3	84	81	25.3
32209 AK	82	88	67	45	55	4	0.5	0.3	89	86	25.3
32210 AK	87.5	93	71	50	60	4	0.5	0.3	94	91	25.3
32211 AK	97	103	78	55	68	4.5	0.5	0.3	104	101	27.3
32212 AK	106.5	113	85	60	73	4.5	0.5	0.5	114	111	30.5
32213 AK	116.5	123	93	65	78	4.5	0.5	0.5	124	121	33.5
32214 AK	121	128	98	70	83	5	0.5	0.5	129	126	34
32215 AK	127	133	104	75	88	5	0.5	0.5	134	131	34
32216 AK	136	143	110	80	95	5	0.5	0.5	144	141	36
32217 AK	146	153	117	85	100	5	0.5	0.5	154	151	39.5
32218 AK	156	163	125	90	105	5	0.5	0.5	164	161	43.5
32219 AK	165	173	133	95	115	5	0.5	0.5	174	171	46.5
32220 AK	175	183	140	100	120	5	0.5	0.5	184	181	50
32221 AK	185	193	148	105	125	5	0.5	0.5	194	191	54
32222 AK	195	203	156	110	135	5	0.5	0.5	204	201	57
32224 AK	210	218	165	120	145	5	0.5	0.5	219	216	62.5
32226 AK	220	233	178	130	160	5	0.5	0.5	234	231	68.5
32228 AK	240	253	192	140	170	5	0.5	0.5	254	251	72.5
32230 AK	260	273	208	150	180	5	0.5	0.5	274	271	78.5

*See page 5 for mounting instructions

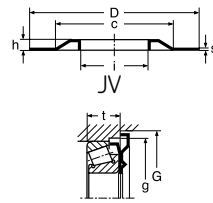
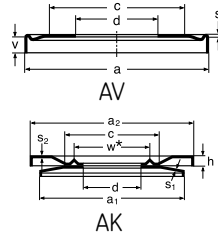
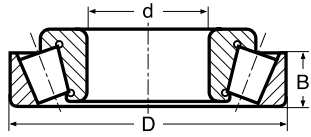

Bearing	d	D	B
30302	15	42	11
30303	17	47	12
30304	20	52	13
30305	25	62	15
30306	30	72	16
30307	35	80	18
30308	40	90	20
30309	45	100	22
30310	50	110	23
30311	55	120	25
30312	60	130	26
30313	65	140	28
30314	70	150	30
30315	75	160	31
30316	80	170	33
30317	85	180	34
30318	90	190	36
30319	95	200	38
30320	100	215	39
30321	105	225	41
30322	110	240	42
30324	120	260	46
30326	130	280	49
30328	140	300	53
30330	150	320	55
30332	160	340	58
30334	170	360	62
30336	180	380	64

NILOS-Ring	a	c	d	s	v
30302 AV	40	30	15	0.3	3.6
30303 AV	45	36	17	0.3	3.6
30304 AV	49	40	20	0.3	3.6
30305 AV	60	47	25	0.3	3.6
30306 AV	69.5	55	30	0.3	5.1
30307 AV	77.5	61	35	0.3	5.1
30308 AV	87.5	71	40	0.3	5.6
30309 AV	97	78	45	0.3	5.6
30310 AV	106.5	85	50	0.5	6.6
30311 AV	116.5	93	55	0.5	7.1
30312 AV	127	104	60	0.5	8.1
30313 AV	136	110	65	0.5	8.6
30314 AV	146	117	70	0.5	8.6
30315 AV	156	125	75	0.5	9.6
30316 AV	165	133	80	0.5	10.1
30317 AV	175	140	85	0.5	11.1
30318 AV	185	148	90	0.5	11.1
30319 AV	195	156	95	0.5	12.1
30320 AV	210	165	100	0.5	13.1
30321 AV	220	178	105	0.5	13.1
30322 AV	235	190	110	0.5	13.1
30324 AV	255	205	120	0.5	14.1
30326 AV	274	235	130	0.5	15.7
30328 AV	294	255	140	0.5	15.7
30330 AV	310	270	150	0.5	18.2
30332 AV	330	290	160	0.5	18.2
30334 AV	350	310	170	0.7	19.2
30336 AV	370	315	180	0.7	20.1

NILOS-Ring	i	c	D	h	s	v
30302 JV	19	32	42	2	0.3	1.6
30303 JV	20.5	36	47	2	0.3	1.6
30304 JV	24.5	40	52	2	0.3	1.6
30305 JV	30	49	62	2.5	0.3	1.6
30306 JV	37.2	56	72	2.5	0.3	2.1
30307 JV	41.9	63	80	3	0.3	2.1
30308 JV	47.5	70	90	3	0.3	2.6
30309 JV	52.3	80	100	3	0.5	2.6
30310 JV	57.5	87	110	3	0.5	2.6
30311 JV	64	95	120	3	0.5	3.1
30312 JV	69.3	104	130	3	0.5	3.1
30313 JV	75.3	110	140	3.5	0.5	3.6
30314 JV	81	125	150	3.5	0.5	3.6
30315 JV	87.2	128	160	3.5	0.5	3.6
30316 JV	92.3	135	170	3.5	0.5	4.1
30317 JV	97.8	144	180	4	0.5	4.1
30318 JV	106	150	190	4	0.5	4.1
30319 JV	110.5	160	200	4	0.5	5.1
30320 JV	116	170	215	4	0.5	5.1
30321 JV	121	160	225	4	0.5	5.1
30322 JV	126	195	240	4	0.5	5.1
30324 JV	136	215	260	4	0.5	5.1

Bearing	d	D	B
30302	15	42	11
30303	17	47	12
30304	20	52	13
30305	25	62	15
30306	30	72	16
30307	35	80	18
30308	40	90	20
30309	45	100	22
30310	50	110	23
30311	55	120	25
30312	60	130	26
30313	65	140	28
30314	70	150	30
30315	75	160	31
30316	80	170	33
30317	85	180	34
30318	90	190	36
30319	95	200	38
30320	100	215	39
30321	105	225	41
30322	110	240	42
30324	120	260	46
30326	130	280	49

NILOS-Ring	a ₁	a ₂	c	d	w*	h	s ₁	s ₂	G	g	t
30302 AK	40	45	30	15	21	3	0.3	0.5	46	43	14.8
30303 AK	45	50	36	17	24	3	0.3	0.5	51	48	15.8
30304 AK	49	55	40	20	28	3	0.3	0.5	56	53	16.8
30305 AK	60	65	47	25	33	3	0.3	0.5	66	63	18.8
30306 AK	69.5	75	55	30	39	4	0.3	0.5	76	73	21.3
30307 AK	77.5	83	61	35	46	4	0.3	0.5	84	81	23.3
30308 AK	87.5	93	71	40	52	4	0.3	0.5	94	91	25.8
30309 AK	97	103	78	45	57	4.5	0.3	0.5	104	101	27.8
30310 AK	106.5	113	85	50	63	4.5	0.5	0.5	114	111	30
30311 AK	116.5	123	93	55	70	4.5	0.5	0.5	124	121	32.5
30312 AK	127	133	104	60	80	5	0.5	0.5	134	131	34.5
30313 AK	136	143	110	65	85	5	0.5	0.5	144	141	37
30314 AK	146	153	117	70	90	5	0.5	0.5	154	151	39
30315 AK	156	163	125	75	95	5	0.5	0.5	164	161	41
30316 AK	165	173	133	80	100	5	0.5	0.5	174	171	43.5
30317 AK	175	183	140	85	105	5	0.5	0.5	184	181	45.5
30318 AK	185	193	148	90	115	5	0.5	0.5	194	191	47.5
30319 AK	195	203	156	95	120	5	0.5	0.5	204	201	50.5
30320 AK	210	218	165	100	125	5	0.5	0.5	219	216	52.5
30321 AK	220	228	178	105	130	5	0.5	0.5	229	226	54.5
30322 AK	235	243	190	110	140	5	0.5	0.5	244	241	55.5
30324 AK	255	263	205	120	150	5	0.5	0.5	264	261	60.5
30326 AK	274	286	235	130	160	5	0.5	0.5	287	281	65

*See page 5 for mounting instructions

NILOS-Rings for single row taper roller bearings

Series 313

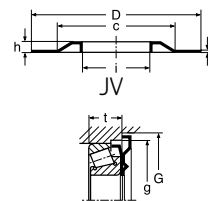
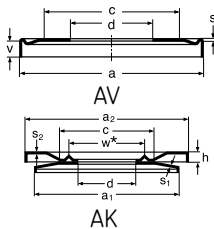
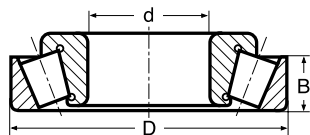

Bearing	d	D	B
31305	25	62	13
31306	30	72	14
31307	35	80	15
31308	40	90	17
31309	45	100	18
31310	50	110	19
31311	55	120	21
31312	60	130	22
31313	65	140	23
31314	70	150	25
31315	75	160	37
31316	80	170	39
31317	85	180	41
31318	90	190	43
31319	95	200	45

NILOS-Ring	a	c	d	s	v
31305 AV	60	47	25	0.3	5.6
31306 AV	69.5	55	30	0.3	7.1
31307 AV	77.5	61	35	0.3	8.7
31308 AV	87.5	71	40	0.3	8.6
31309 AV	97	78	45	0.3	9.6
31310 AV	106.5	85	50	0.5	10.6
31311 AV	116.5	98	55	0.5	11.1
31312 AV	127	104	60	0.5	12.1
31313 AV	136	110	65	0.5	13.6
31314 AV	146	124	70	0.5	13.6
31315 AV	156	125	75	0.5	14.6
31316 AV	165	133	80	0.5	16.1
31317 AV	175	140	85	0.5	17.1
31318 AV	185	148	90	0.5	17.1
31319 AV	195	156	95	0.5	18.1

NILOS-Ring	i	c	D	h	s	v
31305 JV	30	49	62	2.5	0.3	1.6
31306 JV	37.2	56	72	2.5	0.3	2.1
31307 JV	41.9	63	80	3	0.3	2.1
31308 JV	47.5	70	90	3	0.3	2.6
31309 JV	52.3	80	100	3	0.5	2.6
31310 JV	57.5	87	110	3	0.5	2.6
31311 JV	64	95	120	3	0.5	3.1
31312 JV	69.3	104	130	3	0.5	3.1
31313 JV	75.3	110	140	3.5	0.5	3.6
31314 JV	81	125	150	3.5	0.5	3.6
31315 JV	87.2	128	160	3.5	0.5	3.6
31316 JV	92.3	135	170	3.5	0.5	4.1
31317 JV	97.8	144	180	4	0.5	4.1
31318 JV	106	150	190	4	0.5	4.1
31319 JV	110.5	160	200	4	0.5	5.1

Bearing	d	D	B
31305	25	62	13
31306	30	72	14
31307	35	80	15
31308	40	90	17
31309	45	100	18
31310	50	110	19
31311	55	120	21
31312	60	130	22
31313	65	140	23
31314	70	150	25

NILOS-Ring	a ₁	a ₂	c	d	w*	h	s ₁	s ₂	G	g	t
31305 AK	60	65	47	25	33	3	0.3	0.5	66	63	18.8
31306 AK	69.5	75	55	30	39	4	0.3	0.5	76	73	21.3
31307 AK	77.5	83	61	35	46	4	0.3	0.5	84	81	23.3
31308 AK	87.5	93	71	40	52	4	0.3	0.5	94	91	25.8
31309 AK	97	103	78	45	57	4.5	0.3	0.5	104	101	27.8
31310 AK	106.5	113	85	50	63	4.5	0.5	0.5	114	111	30
31311 AK	116.5	123	98	55	70	4.5	0.5	0.5	124	121	32.5
31312 AK	127	133	104	60	80	5	0.5	0.5	134	131	34.5
31313 AK	136	143	110	65	85	5	0.5	0.5	144	141	37
31314 AK	146	153	124	70	90	5	0.5	0.5	154	151	39

*See page 5 for mounting instructions

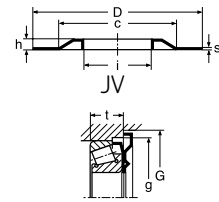
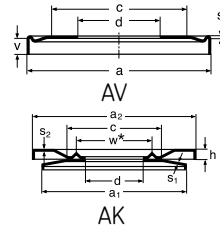
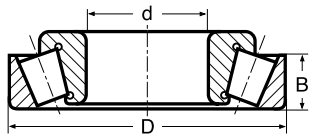

Bearing	d	D	B
32303	17	47	16
32304	20	52	18
32305	25	62	20
32306	30	72	23
32307	35	80	25
32308	40	90	27
32309	45	100	30
32310	50	110	33
32311	55	120	35
32312	60	130	37
32313	65	140	39
32314	70	150	42
32315	75	160	45
32316	80	170	48
32317	85	180	49
32318	90	190	53
32319	95	200	55
32320	100	215	60
32321	105	225	63
32322	110	240	65
32324	120	260	69

NILOS-Ring	a	c	d	s	v
32303 AV	45	36	17	0.3	4.6
32304 AV	49	40	20	0.3	4.6
32305 AV	60	47	25	0.3	5.6
32306 AV	69.5	55	30	0.3	6.1
32307 AV	77.5	61	35	0.3	8.1
32308 AV	87.5	71	40	0.3	8.6
32309 AV	97	78	45	0.3	8.6
32310 AV	106.5	85	50	0.5	9.6
32311 AV	116.5	93	55	0.5	11.1
32312 AV	127	104	60	0.5	12.1
32313 AV	136	110	65	0.5	12.6
32314 AV	146	117	70	0.5	12.6
32315 AV	156	125	75	0.5	13.6
32316 AV	165	133	80	0.5	14.1
32317 AV	175	140	85	0.5	15.1
32318 AV	185	148	90	0.5	15.1
32319 AV	195	156	95	0.5	17.1
32320 AV	210	165	100	0.5	18.1
32321 AV	220	178	105	0.5	19.1
32322 AV	235	190	110	0.5	20.1
32324 AV	255	205	120	0.5	22.1

NILOS-Ring	i	c	D	h	s	v
32304 JV	24.5	40	52	2	0.3	1.6
32305 JV	30	49	62	2.5	0.3	1.6
32306 JV	37.2	56	72	2.5	0.3	2.1
32307 JV	41.9	63	80	3	0.3	2.1
32308 JV	47.5	70	90	3	0.3	2.6
32309 JV	52.3	80	100	3	0.5	2.6
32310 JV	57.5	87	110	3	0.5	2.6
32311 JV	64	95	120	3	0.5	3.1
32312 JV	69.3	104	130	3	0.5	3.1
32313 JV	75.3	110	140	3.5	0.5	3.6
32314 JV	81	125	150	3.5	0.5	3.6
32315 JV	87.2	128	160	3.5	0.5	3.6
32316 JV	92.3	135	170	3.5	0.5	4.1
32317 JV	97.8	144	180	4	0.5	4.1
32318 JV	106	150	190	4	0.5	4.1
32319 JV	110.5	160	200	4	0.5	5.1
32320 JV	116	170	215	4	0.5	5.1
32321 JV	121	160	225	4	0.5	5.1
32322 JV	126	195	240	4	0.5	5.1
32324 JV	136	215	260	4	0.5	5.1

Bearing	d	D	B
32304	20	52	18
32305	25	62	20
32306	30	72	23
32307	35	80	25
32308	40	90	27
32309	45	100	30
32310	50	110	33
32311	55	120	35
32312	60	130	37
32313	65	140	39
32314	70	150	42
32315	75	160	45
32316	80	170	48
32317	85	180	49
32318	90	190	53
32319	95	200	55
32320	100	215	60
32321	105	225	63
32322	110	240	65
32324	120	260	69

NILOS-Ring	a ₁	a ₂	c	d	w*	h	s ₁	s ₂	G	g	t
32304 AK	49	55	40	20	28	3	0.3	0.5	56	53	22.8
32305 AK	60	65	47	25	33	3	0.3	0.5	66	63	25.8
32306 AK	69.5	75	55	30	39	4	0.3	0.5	76	73	29.3
32307 AK	77.5	83	61	35	46	4	0.3	0.5	84	81	33.3
32308 AK	87.5	93	71	40	52	4	0.3	0.5	94	91	35.8
32309 AK	97	103	78	45	57	4.5	0.3	0.5	104	101	38.8
32310 AK	106.5	113	85	50	63	4.5	0.5	0.5	114	111	43
32311 AK	116.5	123	93	55	70	4.5	0.5	0.5	124	121	46.5
32312 AK	127	133	104	60	80	5	0.5	0.5	134	131	49.5
32313 AK	136	143	110	65	85	5	0.5	0.5	144	141	52
32314 AK	146	153	117	70	90	5	0.5	0.5	154	151	55
32315 AK	156	163	125	75	95	5	0.5	0.5	164	161	59
32316 AK	165	173	133	80	100	5	0.5	0.5	174	171	62.5
32317 AK	175	183	140	85	105	5	0.5	0.5	184	181	64.5
32318 AK	185	193	148	90	115	5	0.5	0.5	194	191	68.5
32319 AK	195	203	156	95	120	5	0.5	0.5	204	201	72.5
32320 AK	210	218	165	100	125	5	0.5	0.5	219	216	78.5
32321 AK	220	228	178	105	130	5	0.5	0.5	229	226	82.5
32322 AK	235	243	190	110	140	5	0.5	0.5	244	241	85.5
32324 AK	255	263	205	120	150	5	0.5	0.5	261	261	91.5

*See page 5 for mounting instructions

NILOS-Rings for single row taper roller bearings

Series 332

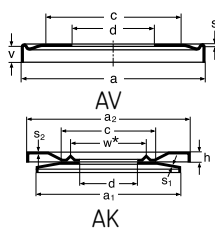
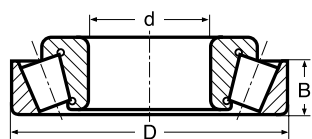

Bearing	d	D	B
33205	25	52	18
33206	30	62	19.5
33207	35	72	22
33208	40	80	25
33209	45	85	25
33210	50	90	24.5
33211	55	100	27
33212	60	110	29
33213	65	120	32
33214	70	125	32
33215	75	130	31
33216	80	140	35
33217	85	150	37
33218	90	160	42
33219	95	170	44
33220	100	180	48
33221	105	190	52

NILOS-Ring	a	c	d	s	v
33205 AV	51	42	25	0.5	4.2
33206 AV	60	47	30	0.5	5.7
33207 AV	69.5	55	35	0.5	6.2
33208 AV	77.5	61	40	0.5	7.2
33209 AV	82	67	45	0.5	7.2
33210 AV	87.5	72	50	0.5	7.7
33211 AV	97	78	55	0.5	8.2
33212 AV	106.5	85	60	0.5	9.2
33213 AV	116.5	98	65	0.5	9.2
33214 AV	121	98	70	0.5	9.2
33215 AV	127	104	75	0.5	10.2
33216 AV	136	110	80	0.5	11.2
33217 AV	146	124	85	0.5	12.2
33218 AV	156	125	90	0.5	13.2
33219 AV	165	133	95	0.5	14.2
33220 AV	175	140	100	0.5	15.2
33221 AV	185	168	105	0.5	16.2

Bearing	d	D	B
33205	25	52	18
33206	30	62	19.5
33207	35	72	22
33208	40	80	25
33209	45	85	25
33210	50	90	24.5
33211	55	100	27
33212	60	110	29
33213	65	120	32
33214	70	125	32
33215	75	130	31
33216	80	140	35
33217	85	150	37
33218	90	160	42
33219	95	170	44
33220	100	180	48
33221	105	190	52

NILOS-Ring	a ₁	a ₂	c	d	w*	h	s ₁	s ₂	G	g	t
33205 AK	51	55	40	25	34	3	0.3	0.5	56	52	22.4
33206 AK	60	65	47	30	38	3	0.3	0.5	66	62	25.4
33207 AK	69.5	75	55	35	45	4	0.3	0.5	76	72	28.4
33208 AK	77.5	83	61	40	50	4	0.3	0.5	84	80	32.4
33209 AK	82	88	67	45	55	4	0.3	0.5	89	85	32.4
33210 AK	87.5	93	71	50	60	4	0.3	0.5	94	90	32.4
33211 AK	97	103	78	55	68	4.5	0.3	0.5	105	100	35.4
33212 AK	106.5	113	85	60	73	4.5	0.5	0.5	115	110	38.6
33213 AK	116.5	123	93	65	78	4.5	0.5	0.5	125	120	41.6
33214 AK	121	128	98	70	83	5	0.5	0.5	130	125	41.6
33215 AK	127	133	104	75	88	5	0.5	0.5	135	130	41.6
33216 AK	136	143	110	80	95	5	0.5	0.5	145	140	41.6
33217 AK	146	153	117	85	100	5	0.5	0.5	155	150	49.6
33218 AK	156	163	125	90	105	5	0.5	0.5	165	160	55.6
33219 AK	165	173	133	95	115	5	0.5	0.5	175	170	58.6
33220 AK	175	183	140	100	120	5	0.5	0.5	185	180	63.6
33221 AK	185	193	148	105	125	5	0.5	0.5	195	190	68.6

*See page 5 for mounting instructions

NILOS-Rings for taper roller bearings, inch size

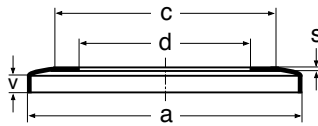
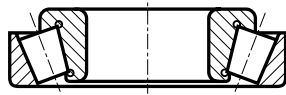

NILOS-Ring	a		c		d		s		v	
	inch	mm	inch	mm	inch	mm	inch	mm	inch	mm
A2047/A2126 AV	1.1417	29.0	0.9843	25	0.4720	11.99	0.0118	0.3	0.0866	2.2
00050/00152 AV	1.4055	35.7	0.9843	25	0.5000	12.70	0.0118	0.3	0.1142	2.9
A4050/A4138 AV	1.2795	32.5	1.0630	27	0.5000	12.70	0.0118	0.3	0.1024	2.6
A4059/A4138 AV	1.2795	32.5	1.0630	27	0.5898	14.98	0.0118	0.3	0.1024	2.6
A4050/A4138B AV	1.2795	32.5	1.0630	27	0.5898	14.98	0.0118	0.3	0.1024	2.6
09062/09196 AV	1.8425	46.8	1.5748	40	0.6248	15.87	0.0118	0.3	0.2402	6.1
17580/17520 AV	1.5748	40.0	1.1811	30	0.6248	15.87	0.0118	0.3	0.1457	3.7
A6062/A6157 AV	1.4961	38.0	1.1811	30	0.6248	15.87	0.0118	0.3	0.1142	2.9
03062/03162 AV	1.4961	38.0	1.1811	30	0.6252	15.88	0.0118	0.3	0.1457	3.7
L21549/L21511 AV	1.2795	32.5	1.0630	27	0.6252	15.88	0.0118	0.3	0.1024	2.6
03066X/03157X AV	1.4961	38.0	1.1811	30	0.6693	17.00	0.0118	0.3	0.1457	3.7
A6157/A6067 AV	1.4961	38.0	1.1811	30	0.6693	17.00	0.0118	0.3	0.1142	2.9
LM11749/LM11710 AV	1.4961	38.0	1.1811	30	0.6874	17.46	0.0118	0.3	0.1457	3.7
05066/5185 AV	1.6929	43.0	1.3386	34	0.7500	19.05	0.0118	0.3	0.1496	3.8
05075/05185S AV	1.6929	43.0	1.3386	34	0.7500	19.05	0.0118	0.3	0.1496	3.8
05075/05185 AV	1.6929	43.0	1.3386	34	0.7500	19.05	0.0118	0.3	0.1496	3.8
05075X/05185 AV	1.6929	43.0	1.3386	34	0.7500	19.05	0.0118	0.3	0.1496	3.8
05075X/05185S AV	1.6929	43.0	1.3386	34	0.7500	19.05	0.0118	0.3	0.1496	3.8
09067/09195 AV	1.8425	46.8	1.5748	40	0.7500	19.05	0.0118	0.3	0.1693	4.3
09067/09196 AV	1.8425	46.8	1.5748	40	0.7500	19.05	0.0118	0.3	0.1693	4.3
09074/09196 AV	1.8425	46.8	1.5748	40	0.7500	19.05	0.0118	0.3	0.2402	6.1
09074/09194 AV	1.8425	46.8	1.5748	40	0.7500	19.05	0.0118	0.3	0.2402	6.1
09078X/09194 AV	1.8425	46.8	1.5748	40	0.7500	19.05	0.0118	0.3	0.2402	6.1
09078X/09196 AV	1.8425	46.8	1.5748	40	0.7500	19.05	0.0118	0.3	0.2402	6.1
21075/21212 AV	2.0472	52.0	1.6929	43	0.7500	19.05	0.0118	0.3	0.2717	6.9
A6075/A6157 AV	1.4961	38.0	1.1811	30	0.7500	19.05	0.0118	0.3	0.1142	2.9
LM11949/LM11910 AV	1.6929	43.0	1.3386	34	0.7500	19.05	0.0118	0.3	0.1535	3.9
05079/05185S AV	1.6929	43.0	1.3386	34	0.7866	19.98	0.0118	0.3	0.1496	3.8
05079/05185 AV	1.6929	43.0	1.3386	34	0.7866	19.98	0.0118	0.3	0.1496	3.8
07079/07196 AV	1.9016	48.3	1.5748	40	0.7894	20.05	0.0118	0.3	0.1772	4.5
12580/12520 AV	1.8425	46.8	1.5748	40	0.8122	20.63	0.0118	0.3	0.1772	4.5
M12649/M12610 AV	1.8425	46.8	1.5748	40	0.8437	21.43	0.0118	0.3	0.1614	4.1
LM12749/LM12710 AV	1.6929	43.0	1.3386	34	0.8661	21.998	0.0118	0.3	0.1535	3.9
LM12749/LM12711 AV	1.6929	43.0	1.3386	34	0.8661	21.998	0.0118	0.3	0.1535	3.9
LL52549/LL52510 AV	1.5748	40.0	1.2992	33	0.8752	22.23	0.0118	0.3	0.1181	3.0
07093/07196AV	1.9016	48.3	1.5748	40	0.9374	23.81	0.0118	0.3	0.1772	4.5
1779/1729 AV	2.1654	55.0	1.7717	45	0.9374	23.81	0.0118	0.3	0.1575	4.0
23092/23256 AV	2.4803	63.0	2.0866	53	0.9394	23.86	0.0118	0.3	0.2717	6.9
07097/07204 AV	1.9291	49.0	1.5748	40	0.9843	25.00	0.0118	0.3	0.1063	2.7
07097/07205 AV	1.9291	49.0	1.5748	40	0.9843	25.00	0.0118	0.3	0.1063	2.7
17098/17244 AV	2.3622	60.0	2.0866	53	0.9843	25.00	0.0118	0.3	0.0866	2.2
07100S/07210X AV	1.9016	48.3	1.5748	40	1.0000	25.40	0.0118	0.3	0.1102	2.8
07100/07204B AV	1.9016	48.3	1.5748	40	1.0000	25.40	0.0118	0.3	0.1102	2.8
07100SL/07196 AV	1.9016	48.3	1.5748	40	1.0000	25.40	0.0118	0.3	0.1772	4.5
07100/07196 AV	1.9016	48.3	1.5748	40	1.0000	25.40	0.0118	0.3	0.1772	4.5
15101/15245 AV	2.3622	60.0	2.0866	53	1.0000	25.40	0.0118	0.3	0.2087	5.3
15100/15245 AV	2.3622	60.0	2.0866	53	1.0000	25.40	0.0118	0.3	0.2087	5.3
15100S/15245 AV	2.3622	60.0	2.0866	53	1.0000	25.40	0.0118	0.3	0.2087	5.3
1985/1922 AV	2.1654	55.0	1.7717	45	1.0000	25.40	0.0118	0.3	0.1772	4.5
1985/1932 AV	2.1654	55.0	1.7717	45	1.0000	25.40	0.0118	0.3	0.1772	4.5
1888/1920 AV	2.1654	55.0	1.7717	45	1.0000	25.40	0.0118	0.3	0.1772	4.5
1988/1922 AV	2.1654	55.0	1.7717	45	1.0000	25.40	0.0118	0.3	0.1772	4.5
1988/1932 AV	2.1654	55.0	1.7717	45	1.0000	25.40	0.0118	0.3	0.1772	4.5
15590/15520 AV	2.1654	55.0	1.7717	45	1.0000	25.40	0.0118	0.3	0.1772	4.5

NILOS-Rings for taper roller bearings, inch size

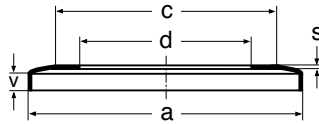
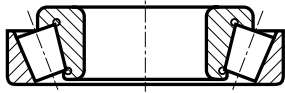

NILOS-Ring	a		c		d		s		v	
	inch	mm	inch	mm	inch	mm	inch	mm	inch	mm
15590/15520B AV	2.1654	55.0	1.7717	45	1.0000	25.40	0.0118	0.3	0.1772	4.5
1986/1932 AV	2.1654	55.0	1.7717	45	1.0000	25.40	0.0118	0.3	0.1772	4.5
1986/1922 AV	2.1654	55.0	1.7717	45	1.0000	25.40	0.0118	0.3	0.1772	4.5
1994X/1922 AV	2.1654	55.0	1.7717	45	1.0000	25.40	0.0118	0.3	0.1772	4.5
23100/23256 AV	2.4803	63.0	2.0866	53	1.0000	25.40	0.0118	0.3	0.2717	6.9
41100/41286 AV	2.7362	69.5	2.1654	55	1.0000	25.40	0.0118	0.3	0.3031	7.7
HM88630/HM88610 AV	2.7520	69.9	2.3228	59	1.0000	25.40	0.0118	0.3	0.2362	6.0
L44643/L44610 AV	1.9016	48.3	1.5748	40	1.0000	25.40	0.0118	0.3	0.1614	4.1
M84548/M84510 AV	2.1654	55.0	1.7717	45	1.0000	25.40	0.0118	0.3	0.2047	5.2
L44649/L44610 AV	1.9016	48.3	1.5748	40	1.0626	26.99	0.0118	0.3	0.1614	4.1
15113/15245 AV	2.3622	60.0	2.0866	53	1.1248	28.57	0.0118	0.3	0.2087	5.3
41125/41286 AV	2.7362	69.5	2.1654	55	1.1248	28.57	0.0118	0.3	0.2992	7.6
41126/41286 AV	2.7362	69.5	2.1654	55	1.1248	28.57	0.0118	0.3	0.2992	7.6
HH46349/HH46310 AV	2.9134	74.0	2.4803	63	1.1248	28.57	0.0118	0.3	0.2717	6.9
L45449/L45410 AV	1.9016	48.3	1.6535	42	1.1417	29.00	0.0118	0.3	0.1575	4.0
17118/17245D AV	2.3622	60.0	2.0866	53	1.1803	29.98	0.0118	0.3	0.0866	2.2
17118/17244 AV	2.3622	60.0	2.0866	53	1.1803	29.98	0.0118	0.3	0.0866	2.2
17118/17244B AV	2.3622	60.0	2.0866	53	1.1803	29.98	0.0118	0.3	0.0866	2.2
17118S/17244 AV	2.3622	60.0	2.0866	53	1.1803	29.98	0.0118	0.3	0.0866	2.2
17119/17244 AV	2.3622	60.0	2.0866	53	1.1874	30.16	0.0118	0.3	0.0866	2.2
17119/17244B AV	2.3622	60.0	2.0866	53	1.1874	30.16	0.0118	0.3	0.0866	2.2
2558/2523 AV	2.6378	67.0	2.1654	55	1.1874	30.16	0.0118	0.3	0.2087	5.3
2558/2523S AV	2.6378	67.0	2.1654	55	1.1874	30.16	0.0118	0.3	0.2087	5.3
M86649/M86610 AV	2.4016	61.0	2.0866	53	1.1874	30.16	0.0118	0.3	0.2087	5.3
2687/2630 AV	2.4016	61.0	2.0866	53	1.1874	30.16	0.0118	0.3	0.2087	5.3
M88043/M88011 AV	2.5709	65.3	2.1260	54	1.1874	30.16	0.0118	0.3	0.2087	5.3
15120/15245 AV	2.3622	60.0	2.0866	53	1.1894	30.21	0.0118	0.3	0.2087	5.3
14116/14276B AV	2.6378	67.0	2.1654	55	1.1898	30.22	0.0118	0.3	0.1772	4.5
02475/02420 AV	2.5394	64.5	2.1260	54	1.2500	31.75	0.0118	0.3	0.2087	5.3
2475/2420 AV	2.5394	64.5	2.1260	54	1.2500	31.75	0.0118	0.3	0.2087	5.3
2580/2520 AV	2.5394	64.5	2.1260	54	1.2500	31.75	0.0118	0.3	0.2087	5.3
08125/08231B AV	2.2441	57.0	1.8504	47	1.2500	31.75	0.0118	0.3	0.1772	4.5
08125/08231 AV	2.2441	57.0	1.8504	47	1.2500	31.75	0.0118	0.3	0.1772	4.5
14125A/14274 AV	2.6378	67.0	2.1654	55	1.2500	31.75	0.0118	0.3	0.1772	4.5
14125A/14276 AV	2.6378	67.0	2.1654	55	1.2500	31.75	0.0118	0.3	0.1772	4.5
15123/15245 AV	2.3622	60.0	2.0866	53	1.2500	31.75	0.0118	0.3	0.1732	4.4
15123/15243 AV	2.3622	60.0	2.0866	53	1.2500	31.75	0.0118	0.3	0.1732	4.4
15126/15245 AV	2.3622	60.0	2.0866	53	1.2500	31.75	0.0118	0.3	0.2087	5.3
15125/15245 AV	2.3622	60.0	2.0866	53	1.2500	31.75	0.0118	0.3	0.2087	5.3
2580/2523S AV	2.6378	67.0	2.1654	55	1.2500	31.75	0.0118	0.3	0.2087	5.3
2580/2523 AV	2.6378	67.0	2.1654	55	1.2500	31.75	0.0118	0.3	0.2087	5.3
2582/2523 AV	2.6378	67.0	2.1654	55	1.2500	31.75	0.0118	0.3	0.2087	5.3
3193/3120 AV	2.7362	69.5	2.1654	55	1.2500	31.75	0.0118	0.3	0.2717	6.9
43125/43312 AV	2.9134	74.0	2.4803	63	1.2500	31.75	0.0118	0.3	0.3346	8.5
43125/43300 AV	2.9134	74.0	2.4803	63	1.2500	31.75	0.0118	0.3	0.3346	8.5
HM88542/HM88510 AV	2.7913	70.9	2.4409	62	1.2500	31.75	0.0118	0.3	0.2717	6.9
LM67048/LM67010 AV	2.2441	57.0	1.8504	47	1.2500	31.75	0.0118	0.3	0.1811	4.6
LM67047/LM67010 AV	2.2441	57.0	1.8504	47	1.2500	31.75	0.0118	0.3	0.1811	4.6
M88046/M88010 AV	2.5709	65.3	2.1260	54	1.2500	31.75	0.0118	0.3	0.2087	5.3
2585/2523 AV	2.6378	67.0	2.1654	55	1.3122	33.33	0.0118	0.3	0.2087	5.3
43131/43312 AV	2.9134	74.0	2.4803	63	1.3122	33.33	0.0118	0.3	0.3346	8.5
43132/43312 AV	2.9134	74.0	2.4803	63	1.3122	33.33	0.0118	0.3	0.3346	8.5
M88048/M88010 AV	2.5709	65.3	2.1260	54	1.3122	33.33	0.0118	0.3	0.2087	5.3
M88048/M88011 AV	2.5709	65.3	2.1260	54	1.3122	33.33	0.0118	0.3	0.2087	5.3

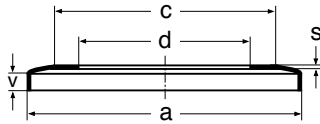
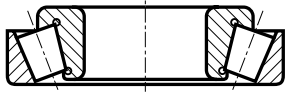

NILOS-Ring	a		c		d		s		v	
	inch	mm	inch	mm	inch	mm	inch	mm	inch	mm
25877/25820 AV	2.7362	69.5	2.1654	55	1.3748	34.92	0.0118	0.3	0.2087	5.3
31593/31520 AV	2.9134	74.0	2.4803	63	1.3748	34.92	0.0118	0.3	0.2402	6.1
31594/31520 AV	2.9134	74.0	2.4803	63	1.3748	34.92	0.0118	0.3	0.2402	6.1
3478/3420 AV	3.0512	77.5	2.4016	61	1.3748	34.92	0.0118	0.3	0.2402	6.1
3872/3820 AV	3.2283	82.0	2.6378	67	1.3748	34.92	0.0118	0.3	0.2717	6.9
HM88649/HM88610 AV	2.7520	69.9	2.3228	59	1.3748	34.92	0.0118	0.3	0.2362	6.0
HM89446/HM89410 AV	2.9134	74.0	2.4803	63	1.3748	34.92	0.0118	0.3	0.2717	6.9
LM48548/LM48510 AV	2.4803	63.0	2.0866	53	1.3748	34.92	0.0118	0.3	0.1811	4.6
M38549/M38510 AV	2.5394	64.5	2.1260	54	1.3752	34.93	0.0118	0.3	0.1772	4.5
14139X/14282 AV	2.6378	67.0	2.1654	55	1.3780	35.00	0.0118	0.3	0.1772	4.5
14139/14276B AV	2.6378	67.0	2.1654	55	1.3780	35.00	0.0118	0.3	0.1772	4.5
14137A/14274 AV	2.6378	67.0	2.1654	55	1.3780	35.00	0.0118	0.3	0.1772	4.5
14137A/14276 AV	2.6378	67.0	2.1654	55	1.3780	35.00	0.0118	0.3	0.1772	4.5
14138/14276 AV	2.6378	67.0	2.1654	55	1.3780	35.00	0.0118	0.3	0.1772	4.5
14138A/14276 AV	2.6378	67.0	2.1654	55	1.3780	35.00	0.0118	0.3	0.1772	4.5
23691/23621 AV	2.7362	69.5	2.1654	55	1.3799	35.05	0.0118	0.3	0.2087	5.3
31597/31521 AV	2.9134	74.0	2.4803	63	1.4374	36.51	0.0118	0.3	0.2402	6.1
3479/3420 AV	3.0512	77.5	2.4803	63	1.4374	36.51	0.0118	0.3	0.2402	6.1
HM89449/HM89411 AV	2.9134	74.0	2.4803	63	1.4374	36.51	0.0118	0.3	0.2717	6.9
HM89449/HM89410 AV	2.9134	74.0	2.4803	63	1.4374	36.51	0.0118	0.3	0.2717	6.9
JL69349/JL69310 AV	2.4016	61.0	2.0866	53	1.4961	38.00	0.0118	0.3	0.1496	3.8
13685/13621 AV	2.6378	67.0	2.1654	55	1.5000	38.10	0.0118	0.3	0.1772	4.5
13687/13621 AV	2.6378	67.0	2.1654	55	1.5000	38.10	0.0118	0.3	0.1772	4.5
13889/13830 AV	2.4016	61.0	2.0866	53	1.5000	38.10	0.0118	0.3	0.1457	3.7
13889/13836 AV	2.6378	67.0	2.1654	55	1.5000	38.10	0.0118	0.3	0.1772	4.5
16150/16282 AV	2.7362	69.5	2.1654	55	1.5000	38.10	0.0118	0.3	0.2087	5.3
16150/16284 AV	2.7362	69.5	2.1654	55	1.5000	38.10	0.0118	0.3	0.2087	5.3
16150/16284B AV	2.7362	69.5	2.1654	55	1.5000	38.10	0.0118	0.3	0.2087	5.3
19150/19268 AV	2.5709	65.3	2.1260	54	1.5000	38.10	0.0118	0.3	0.1772	4.5
2788/2720 AV	2.9134	74.0	2.4803	63	1.5000	38.10	0.0118	0.3	0.2087	5.3
NA24776SW/24720D AV	2.9134	74.0	2.4803	63	1.5000	38.10	0.0118	0.3	0.2087	5.3
2788/2729 AV	2.9134	74.0	2.4803	63	1.5000	38.10	0.0118	0.3	0.2087	5.3
2788/2735X AV	2.7913	70.9	2.4409	62	1.5000	38.10	0.0118	0.3	0.2087	5.3
27880/27820 AV	3.0512	77.5	2.4016	61	1.5000	38.10	0.0118	0.3	0.2598	6.6
27881/27820 AV	3.0512	77.5	2.4016	61	1.5000	38.10	0.0118	0.3	0.2598	6.6
3490/3420 AV	3.0512	77.5	2.4016	61	1.5000	38.10	0.0118	0.3	0.2402	6.1
415/414 AV	3.4055	86.5	2.7953	71	1.5000	38.10	0.0118	0.3	0.2087	5.3
418/414 AV	3.4055	86.5	2.7953	71	1.5000	38.10	0.0118	0.3	0.2087	5.3
44150/44348 AV	3.4055	86.5	2.7953	71	1.5000	38.10	0.0118	0.3	0.3346	8.5
525/522 AV	3.8189	97.0	3.0709	78	1.5000	38.10	0.0118	0.3	0.3346	8.5
527/520X AV	3.8189	97.0	3.0709	78	1.5000	38.10	0.0118	0.3	0.3346	8.5
527/522X AV	3.8189	97.0	3.0709	78	1.5000	38.10	0.0118	0.3	0.3346	8.5
HM801346/HM801310 AV	3.1496	80.0	2.5591	65	1.5000	38.10	0.0118	0.3	0.2717	6.9
LM29749/LM29710 AV	2.4803	63.0	2.0866	53	1.5000	38.10	0.0118	0.3	0.1811	4.6
LM29748/LM297710 AV	2.4803	63.0	2.0866	53	1.5000	38.10	0.0118	0.3	0.1811	4.6
3320/3381 AV	3.0512	77.5	2.4016	61	1.5020	38.15	0.0118	0.3	0.2362	6.0
53150/53375 AV	3.6220	92.0	3.1496	80	1.5020	38.15	0.0118	0.3	0.4252	10.8
2789/2735X AV	2.7913	70.9	2.4409	62	1.5622	39.68	0.0118	0.3	0.2087	5.3
344/332 AV	3.0512	77.5	2.4016	61	1.5748	40.00	0.0118	0.3	0.1457	3.7
HM801349/HM801310 AV	3.1496	80.0	2.5591	65	1.5937	40.48	0.0118	0.3	0.2717	6.9
LM300849/LM300811 AV	2.6181	66.5	2.2441	57	1.6142	41.00	0.0118	0.3	0.1772	4.5
18590/18520 AV	2.7520	69.9	2.3228	59	1.6248	41.27	0.0118	0.3	0.1772	4.5
24780/24720 AV	2.9134	74.0	2.4803	63	1.6248	41.27	0.0118	0.3	0.2087	5.3
24780/24721 AV	2.9134	74.0	2.4803	63	1.6248	41.27	0.0118	0.3	0.2087	5.3

NILOS-Rings for taper roller bearings, inch size

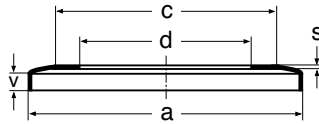
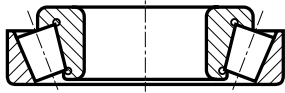

NILOS-Ring	a		c		d		s		v	
	inch	mm	inch	mm	inch	mm	inch	mm	inch	mm
26882/26822 AV	3.0512	77.5	2.4016	61	1.6248	41.27	0.0118	0.3	0.2087	5.3
26882/820 AV	3.0512	77.5	2.4016	61	1.6248	41.27	0.0118	0.3	0.2087	5.3
3576/3525B AV	3.2283	82.0	2.6378	67	1.6248	41.27	0.0118	0.3	0.2717	6.9
3877/3820 AV	3.2283	82.0	2.6378	67	1.6248	41.27	0.0118	0.3	0.2717	6.9
3577/3525B AV	3.2283	82.0	2.6378	67	1.6248	41.27	0.0118	0.3	0.2717	6.9
3585/3520 AV	3.2283	82.0	2.6378	67	1.6248	41.27	0.0118	0.3	0.2717	6.9
3585/3525 AV	3.2283	82.0	2.6378	67	1.6248	41.27	0.0118	0.3	0.2717	6.9
44162/44348 AV	3.4055	86.5	2.7953	71	1.6248	41.27	0.0118	0.3	0.3346	8.5
53162/53375 AV	3.6220	92.0	3.1496	80	1.6248	41.27	0.0118	0.3	0.4291	10.9
11162/11300 AV	2.9134	74.0	2.4803	63	1.6252	41.28	0.0118	0.3	0.1654	4.2
HM803146/HM803110 AV	3.4055	86.5	2.7953	71	1.6252	41.28	0.0118	0.3	0.3031	7.7
HM903245/HM903210 AV	3.6220	92.0	3.1496	80	1.6252	41.28	0.0118	0.3	0.3661	9.3
LM501349/LM501310 AV	2.7913	70.9	2.4409	62	1.6252	41.28	0.0118	0.3	0.2087	5.3
25577/25520 AV	3.1496	80.0	2.5591	65	1.6878	42.87	0.0118	0.3	0.2087	5.3
25576/25520 AV	3.1496	80.0	2.5591	65	1.6878	42.87	0.0118	0.3	0.2087	5.3
25577/25523 AV	3.1496	80.0	2.5591	65	1.6878	42.87	0.0118	0.3	0.2087	5.3
18685/18620 AV	2.9724	75.5	2.6378	67	1.7500	44.45	0.0118	0.3	0.1772	4.5
25580/25522 AV	3.1496	80.0	2.5591	65	1.7500	44.45	0.0118	0.3	0.2087	5.3
35175/35326 AV	3.1496	80.0	2.5591	65	1.7500	44.45	0.0118	0.3	0.2087	5.3
25580/25520 AV	3.1496	80.0	2.5591	65	1.7500	44.45	0.0118	0.3	0.2087	5.3
25580/25523 AV	3.1496	80.0	2.5591	65	1.7500	44.45	0.0118	0.3	0.2087	5.3
25581/25520 AV	3.1496	80.0	2.5591	65	1.7500	44.45	0.0118	0.3	0.2087	5.3
25581/25522AV	3.1496	80.0	2.5591	65	1.7500	44.45	0.0118	0.3	0.2087	5.3
3578/3525 AV	3.2283	82.0	2.6378	67	1.7500	44.45	0.0118	0.3	0.2717	6.9
354A/355A AV	3.2283	82.0	2.6378	67	1.7500	44.45	0.0118	0.3	0.2717	6.9
3578/3525B AV	3.2283	82.0	2.6378	67	1.7500	44.45	0.0118	0.3	0.2717	6.9
435/432 AV	3.6220	92.0	3.1496	80	1.7500	44.45	0.0118	0.3	0.2402	6.1
49175/49368 AV	3.5630	90.5	2.8346	72	1.7500	44.45	0.0118	0.3	0.2717	6.9
3720/3782 AV	3.5630	90.5	2.8346	72	1.7500	44.45	0.0118	0.3	0.2717	6.9
527/522 AV	3.8189	97.0	3.0709	78	1.7500	44.45	0.0118	0.3	0.3346	8.5
53176/53375 AV	3.6220	92.0	3.1496	80	1.7500	44.45	0.0118	0.3	0.4252	10.8
53177/53375 AV	3.6220	92.0	3.1496	80	1.7500	44.45	0.0118	0.3	0.4252	10.8
53176/53387 AV	3.7402	95.0	3.2677	83	1.7500	44.45	0.0118	0.3	0.4291	10.9
5356/5335 AV	3.9764	101.0	3.1496	80	1.7500	44.45	0.0118	0.3	0.3031	7.7
59175/59412 AV	3.9764	101.0	3.1496	80	1.7500	44.45	0.0118	0.3	0.3346	8.5
HM803149/HM803110 AV	3.4055	86.5	2.7953	71	1.7500	44.45	0.0118	0.3	0.3031	7.7
HM903249/HM903210 AV	3.6220	92.0	3.1496	80	1.7500	44.45	0.0118	0.3	0.3661	9.3
L102849/L102810 AV	2.7913	70.9	2.4409	62	1.7500	44.45	0.0118	0.3	0.1457	3.7
LL103049/LL103010 AV	2.7362	69.5	2.3228	59	1.7500	44.45	0.0118	0.3	0.1457	3.7
55175/55437 AV	4.1929	106.5	3.3465	85	1.7520	44.50	0.0197	0.5	0.3976	10.1
3776/3720 AV	3.5630	90.5	2.8346	72	1.7709	44.98	0.0118	0.3	0.2717	6.9
3776/3720B AV	3.5630	90.5	2.8346	72	1.7709	44.98	0.0118	0.3	0.2717	6.9
25584/25518AV	3.0945	78.6	2.6772	68	1.7717	45.00	0.0118	0.3	0.2087	5.3
25584A/25518 AV	3.0945	78.6	2.6772	68	1.7717	45.00	0.0118	0.3	0.2087	5.3
25584/25526 AV	3.2283	82.0	2.6378	67	1.7717	45.00	0.0118	0.3	0.2087	5.3
LM603049/LM603011 AV	2.9724	75.5	2.6378	67	1.7811	45.24	0.0118	0.3	0.2087	5.3
LM603049/LM603012 AV	2.9724	75.5	2.6378	67	1.7811	45.24	0.0118	0.3	0.2087	5.3
LM102949/LM102910 AV	2.7913	70.9	2.4409	62	1.7831	45.29	0.0118	0.3	0.1693	4.3
25590/25520 AV	3.1496	80.0	2.5591	65	1.7961	45.62	0.0118	0.3	0.2087	5.3
LM503349/LM503310 AV	2.8740	73.0	2.4803	63	1.8110	46.00	0.0118	0.3	0.1772	4.5
18690/18620 AV	2.9724	75.5	2.6378	67	1.8122	46.03	0.0118	0.3	0.1772	4.5
436/432 AV	3.6220	92.0	3.1496	80	1.8122	46.03	0.0118	0.3	0.2402	6.1
3777/3720 AV	3.5630	90.5	2.8346	72	1.8146	46.09	0.0118	0.3	0.2717	6.9
3695/362A AV	3.4055	86.5	2.7953	71	1.8748	47.62	0.0118	0.3	0.185	4.7

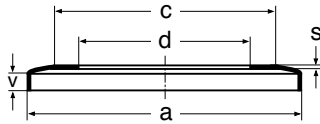
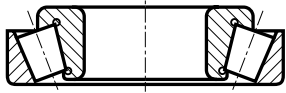

NILOS-Ring	a		c		d		s		v	
	inch	mm	inch	mm	inch	mm	inch	mm	inch	mm
55187C/55443 AV	4.2323	107.5	3.5433	90	1.8750	47.63	0.0197	0.5	0.3937	10.0
55187/55443 AV	4.2323	107.5	3.5433	90	1.8750	47.63	0.0197	0.5	0.3937	10.0
HM804846/HM804810 AV	3.6220	92.0	3.1496	80	1.8756	47.64	0.0118	0.3	0.2992	7.6
72187/72487 AV	4.6850	119.0	3.8583	98	1.8772	47.68	0.0197	0.5	0.4567	11.6
HM804848/HM804810 AV	3.6220	92.0	3.1496	80	1.9059	48.41	0.0118	0.3	0.2992	7.6
3781/3720 AV	3.5630	90.5	2.8346	72	1.9374	49.21	0.0118	0.3	0.2717	6.9
5395/5335 AV	3.9764	101.0	3.1496	80	1.9374	49.21	0.0118	0.3	0.3031	7.7
HM807044/HM807010 AV	3.9764	101.0	3.1496	80	1.9378	49.22	0.0118	0.3	0.3346	8.5
365/362 AV	3.4449	87.5	2.7953	71	1.9685	50.00	0.0118	0.3	0.185	4.7
366/362B AV	3.4449	87.5	2.7953	71	1.9685	50.00	0.0118	0.3	0.185	4.7
365/363D AV	3.4449	87.5	2.7953	71	1.9685	50.00	0.0118	0.3	0.1772	4.5
465/453A AV	4.1142	104.5	3.5433	90	1.9685	50.00	0.0118	0.3	0.2402	6.1
JHM807045/JHM807012 AV	3.9764	101.0	3.1496	80	1.9685	50.00	0.0118	0.3	0.3228	8.2
JLM104948/JLM104910 AV	3.0945	78.6	2.6772	68	1.9685	50.00	0.0118	0.3	0.185	4.7
JLM704649/JLM704610 AV	3.2283	82.0	2.6378	67	1.9685	50.00	0.0118	0.3	0.185	4.7
JM205149/JM205110 AV	3.4449	87.5	2.7953	71	1.9685	50.00	0.0118	0.3	0.2047	5.2
18337/18200 AV	3.2283	82.0	2.6378	67	2.0000	50.80	0.0118	0.3	0.2717	6.9
18790/18720 AV	3.2283	82.0	2.6378	67	2.0000	50.80	0.0118	0.3	0.1772	4.5
33889/33821 AV	3.6220	92.0	3.1496	80	2.0000	50.80	0.0118	0.3	0.2402	6.1
368/362A AV	3.4055	86.5	2.7953	71	2.0000	50.80	0.0118	0.3	0.1811	4.6
368A/362A AV	3.4055	86.5	2.7953	71	2.0000	50.80	0.0118	0.3	0.1811	4.6
368A/362 AV	3.4449	87.5	2.7953	71	2.0000	50.80	0.0118	0.3	0.1811	4.6
368/362 AV	3.4449	87.5	2.7953	71	2.0000	50.80	0.0118	0.3	0.1811	4.6
368A/363D AV	3.4449	87.5	2.7953	71	2.0000	50.80	0.0118	0.3	0.1772	4.5
368/363D AV	3.4449	87.5	2.7953	71	2.0000	50.80	0.0118	0.3	0.1772	4.5
375/372A AV	3.6220	92.0	3.1496	80	2.0000	50.80	0.0118	0.3	0.1457	3.7
3780/3720 AV	3.5630	90.5	2.8346	72	2.0000	50.80	0.0118	0.3	0.2717	6.9
NA3780SW/3729D AV	3.5630	90.5	2.8346	72	2.0000	50.80	0.0118	0.3	0.2717	6.9
3780/3720B AV	3.5630	90.5	2.8346	72	2.0000	50.80	0.0118	0.3	0.2717	6.9
3775/3720 AV	3.5630	90.5	2.8346	72	2.0000	50.80	0.0118	0.3	0.2717	6.9
39573/39520 AV	4.3307	110.0	3.7795	96	2.0000	50.80	0.0197	0.5	0.2717	6.9
45285/45220 AV	3.9764	101.0	3.1496	80	2.0000	50.80	0.0118	0.3	0.2717	6.9
49585/49520 AV	3.8189	97.0	3.0709	78	2.0000	50.80	0.0118	0.3	0.2717	6.9
529X/522 AV	3.8189	97.0	3.0709	78	2.0000	50.80	0.0118	0.3	0.3346	8.5
529/522 AV	3.8189	97.0	3.0709	78	2.0000	50.80	0.0118	0.3	0.3346	8.5
529/522B AV	3.8189	97.0	3.0709	78	2.0000	50.80	0.0118	0.3	0.3346	8.5
537/532A AV	3.9764	101.0	3.1496	80	2.0000	50.80	0.0118	0.3	0.3346	8.5
HM807046/HM807010 AV	3.9764	101.0	3.1496	80	2.0000	50.80	0.0118	0.3	0.3346	8.5
HM807046/HM807011 AV	3.9764	101.0	3.1496	80	2.0000	50.80	0.0118	0.3	0.3346	8.5
55200/55437 AV	4.1929	106.5	3.3465	85	2.0000	50.80	0.0197	0.5	0.3976	10.1
HM907643/HM907614 AV	4.1929	106.5	3.3465	85	2.0000	50.80	0.0197	0.5	0.3976	10.1
619/612 AV	4.5866	116.5	3.8583	98	2.0000	50.80	0.0197	0.5	0.3976	10.1
LL205449/LL205410 AV	2.9724	75.5	2.6378	67	2.0000	50.80	0.0118	0.3	0.1417	3.6
LM104949/LM104911 AV	3.1496	80.0	2.5591	65	2.0000	50.80	0.0118	0.3	0.2205	5.6
LM104949/LM104912 AV	3.1496	80.0	2.5591	65	2.0000	50.80	0.0118	0.3	0.2205	5.6
28521/28584 AV	3.5630	90.5	2.8346	72	2.0622	52.38	0.0118	0.3	0.2087	5.3
33891/33821 AV	3.6220	92.0	3.1496	80	2.0622	52.38	0.0118	0.3	0.2402	6.1
4595/4535 AV	3.9764	101.0	3.1496	80	2.1248	53.97	0.0118	0.3	0.2717	6.9
539/532XAV	4.1142	104.5	3.5433	90	2.1248	53.97	0.0118	0.3	0.3346	8.5
6280/6220 AV	4.8819	124.0	4.5276	115	2.1248	53.97	0.0197	0.5	0.3976	10.1
72212/72487 AV	4.6850	119.0	3.8583	98	2.1248	53.97	0.0197	0.5	0.4606	11.7
66212/66462 AV	4.4488	113.0	3.8583	98	2.1252	53.98	0.0197	0.5	0.3976	10.1
HM807049/HM807010 AV	3.9764	101.0	3.1496	80	2.1252	53.98	0.0118	0.3	0.3346	8.5
LM806649/LM806610 AV	3.4055	86.5	2.7953	71	2.1268	54.02	0.0118	0.3	0.2402	6.1

NILOS-Rings for taper roller bearings, inch size

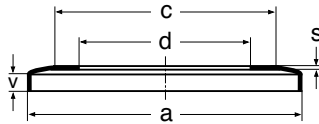
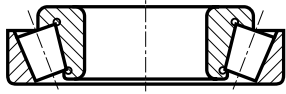

NILOS-Ring	a		c		d		s		v	
	inch	mm	inch	mm	inch	mm	inch	mm	inch	mm
HM807048/HM807010 AV	3.9764	101.0	3.1496	80	2.1457	54.50	0.0118	0.3	0.3346	8.5
JH307749/JH307710 AV	4.1929	106.5	3.3465	85	2.1654	55.00	0.0197	0.5	0.2835	7.2
JLM506849/JLM506810 AV	3.4803	88.4	2.9921	76	2.1654	55.00	0.0118	0.3	0.1850	4.7
JM207049/JM207010 AV	3.6220	92.0	3.1496	80	2.1654	55.00	0.0118	0.3	0.2244	5.7
28682/28622 AV	3.7402	95.0	3.2677	83	2.2500	57.15	0.0118	0.3	0.2244	5.7
387/382A AV	3.7402	95.0	3.2677	83	2.2500	57.15	0.0118	0.3	0.2244	5.7
387A/382A AV	3.7402	95.0	3.2677	83	2.2500	57.15	0.0118	0.3	0.2244	5.7
387/382 AV	3.7402	95.0	3.2677	83	2.2500	57.15	0.0118	0.3	0.1457	3.7
387A/382 AV	3.7402	95.0	3.2677	83	2.2500	57.15	0.0118	0.3	0.1457	3.7
39581/39520 AV	4.3307	110.0	3.7795	96	2.2500	57.15	0.0197	0.5	0.2717	6.9
3979/3920 AV	4.3307	110.0	3.7795	96	2.2500	57.15	0.0197	0.5	0.2717	6.9
462/453X AV	3.9763	101.0	3.1496	80	2.2500	57.15	0.0118	0.3	0.2402	6.1
623/612 AV	4.5866	116.5	3.8583	98	2.2500	57.15	0.0197	0.5	0.3976	10.1
66225/66462 AV	4.4488	113.0	3.8583	98	2.2500	57.15	0.0197	0.5	0.3976	10.1
L507949/L507910 AV	3.3268	84.5	2.9528	75	2.2500	57.15	0.0118	0.3	0.1772	4.5
L507949/L507910B AV	3.3268	84.5	2.9528	75	2.2500	57.15	0.0118	0.3	0.1772	4.5
388A/382A AV	3.7402	95.0	3.2677	83	2.2650	57.53	0.0118	0.3	0.2244	5.7
388A/383A AV	3.8189	97.0	3.0709	78	2.2650	57.53	0.0118	0.3	0.1457	3.7
397/394A AV	4.2323	107.5	3.5433	90	2.3622	60.00	0.0197	0.5	0.1457	3.7
3977/3920 AV	4.3307	110.0	3.7795	96	2.3622	60.00	0.0197	0.5	0.2717	6.9
66585/66520 AV	4.6850	119.0	3.8583	98	2.3622	60.00	0.0197	0.5	0.3976	10.1
JLM508748/JLM508710 AV	3.6220	92.0	3.1496	80	2.3622	60.00	0.0118	0.3	0.2047	5.2
28985/28920 AV	3.8189	97.0	3.3465	85	2.3748	60.32	0.0118	0.3	0.2402	6.1
28985/28921 AV	3.8189	97.0	3.3465	85	2.3748	60.32	0.0118	0.3	0.2402	6.1
3980/3920 AV	4.3307	110.0	3.7795	96	2.3748	60.32	0.0197	0.5	0.2717	6.9
3980/3925 AV	4.3307	110.0	3.7795	96	2.3748	60.32	0.0197	0.5	0.2717	6.9
65500/65237 AV	4.7638	121.0	4.1732	106	2.3748	60.32	0.0197	0.5	0.3976	10.1
HM911245/HM911210 AV	5.0000	127.0	4.0945	104	2.3752	60.33	0.0197	0.5	0.5197	13.2
HM911249/HM911210 AV	5.0000	127.0	4.0945	104	2.4374	61.91	0.0197	0.5	0.5197	13.2
29585/29520B AV	4.1142	104.5	3.5433	90	2.5000	63.50	0.0118	0.3	0.2717	6.9
29585/29520 AV	4.1142	104.5	3.5433	90	2.5000	63.50	0.0118	0.3	0.2717	6.9
39250/39412 AV	3.9764	101.0	3.1496	80	2.5000	63.50	0.0118	0.3	0.2402	6.1
395/394A AV	4.2323	107.5	3.5433	90	2.5000	63.50	0.0197	0.5	0.1457	3.7
3982/3920 AV	4.3307	110.0	3.7795	96	2.5000	63.50	0.0197	0.5	0.2717	6.9
39585/39520 AV	4.3307	110.0	3.7795	96	2.5000	63.50	0.0197	0.5	0.2717	6.9
39585/39521 AV	4.3307	110.0	3.7795	96	2.5000	63.50	0.0197	0.5	0.2717	6.9
3982/3920B AV	4.3307	110.0	3.7795	96	2.5000	63.50	0.0197	0.5	0.2717	6.9
3982/3925 AV	4.3307	110.0	3.7795	96	2.5000	63.50	0.0197	0.5	0.2717	6.9
5584/5535 AV	4.6850	119.0	3.8583	98	2.5000	63.50	0.0197	0.5	0.3031	7.7
565/563 AV	4.7638	121.0	4.1732	106	2.5000	63.50	0.0197	0.5	0.3346	8.5
78551/78250 AV	5.3543	136.0	4.3307	110	2.5000	63.50	0.0197	0.5	0.5315	13.5
78550/78250 AV	5.3543	136.0	4.3307	110	2.5000	63.50	0.0197	0.5	0.5315	13.5
L610549/L610510 AV	3.5630	90.5	3.1496	80	2.5000	63.50	0.0118	0.3	0.1772	4.5
LL510749/LL510710 AV	3.5630	90.5	3.1496	80	2.5000	63.50	0.0118	0.3	0.1772	4.5
01/02/2513 AV	3.6220	92.0	3.1496	80	2.5591	65.00	0.0118	0.3	0.1713	4.4
399/394A AV	4.2323	107.5	3.5433	90	2.5591	65.00	0.0197	0.5	0.1457	3.7
JH211749/JH211710 AV	4.5866	116.5	3.8583	98	2.5591	65.00	0.0197	0.5	0.2835	7.2
JLM710949/JLM710910 AV	4.0551	103.0	3.3465	85	2.5591	65.00	0.0197	0.5	0.2244	5.7
JM511946/JM511910 AV	4.2323	107.5	3.5433	90	2.5591	65.00	0.0197	0.5	0.2244	5.7
478/472A AV	4.5866	116.5	3.8583	98	2.5610	65.05	0.0197	0.5	0.2402	6.1
478/472 AV	4.5866	116.5	3.8583	98	2.5610	65.05	0.0197	0.5	0.2402	6.1
29590/29520B AV	4.1142	104.5	3.5433	90	2.6248	66.67	0.0118	0.3	0.2717	6.9
29590/29520 AV	4.1142	104.5	3.5433	90	2.6248	66.67	0.0118	0.3	0.2717	6.9
29590/29521 AV	4.1142	104.5	3.5433	90	2.6248	66.67	0.0118	0.3	0.2717	6.9

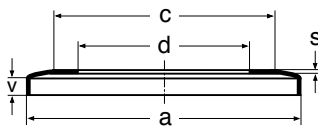

NILOS-Ring	a		c		d		s		v	
	inch	mm	inch	mm	inch	mm	inch	mm	inch	mm
3984/3920 AV	4.3307	110.0	3.7795	96	2.6248	66.67	0.0197	0.5	0.2717	6.9
3984/3920B AV	4.3307	110.0	3.7795	96	2.6248	66.67	0.0197	0.5	0.2717	6.9
3994/3920 AV	4.3307	110.0	3.7795	96	2.6248	66.67	0.0197	0.5	0.2717	6.9
39590/39520 AV	4.3307	110.0	3.7795	96	2.6248	66.67	0.0197	0.5	0.2717	6.9
6389/6320 AV	5.1969	132.0	4.3307	110	2.6248	66.67	0.0197	0.5	0.3976	10.1
6386/6320 AV	5.1969	132.0	4.3307	110	2.6248	66.67	0.0197	0.5	0.3976	10.1
6389/6320B AV	5.1969	132.0	4.3307	110	2.6248	66.67	0.0197	0.5	0.3976	10.1
H715341/H715311 AV	5.1969	132.0	4.3307	110	2.6248	66.67	0.0197	0.5	0.3976	10.1
HM212049/HM212010 AV	4.6850	119.0	3.8583	98	2.6248	66.67	0.0197	0.5	0.3504	8.9
395S/394A AV	4.2323	107.5	3.5433	90	2.6250	66.68	0.0197	0.5	0.1457	3.7
395A/394A AV	4.2323	107.5	3.5433	90	2.6250	66.68	0.0197	0.5	0.1457	3.7
560/552A AV	4.6850	119.0	3.8583	98	2.6252	66.68	0.0197	0.5	0.3346	8.5
399A/394D AV	4.2323	107.5	3.5433	90	2.6875	68.26	0.0197	0.5	0.1457	3.7
399A/394A AV	4.2323	107.5	3.5433	90	2.6875	68.26	0.0197	0.5	0.1457	3.7
399SA/394A AV	4.2323	107.5	3.5433	90	2.6875	68.26	0.0197	0.5	0.1457	3.7
29675/29620 AV	4.3307	110.0	3.7795	96	2.7500	69.85	0.0197	0.5	0.2717	6.9
47487/47420 AV	4.5866	116.5	3.8583	98	2.7500	69.85	0.0197	0.5	0.2717	6.9
482/472 AV	4.5866	116.5	3.8583	98	2.7500	69.85	0.0197	0.5	0.2402	6.1
482/472A AV	4.5866	116.5	3.8583	98	2.7500	69.85	0.0197	0.5	0.2402	6.1
482/472B AV	4.5866	116.5	3.8583	98	2.7500	69.85	0.0197	0.5	0.2402	6.1
482/472X AV	4.7638	121.0	4.1732	106	2.7500	69.85	0.0197	0.5	0.2402	6.1
566/563 AV	4.7638	121.0	4.1732	106	2.7500	69.85	0.0197	0.5	0.3346	8.5
643/632 AV	5.1969	132.0	4.3307	110	2.7500	69.85	0.0197	0.5	0.3976	10.1
HM914545/HM914510 AV	5.5906	142.0	4.5669	116	2.7500	69.85	0.0197	0.5	0.5197	13.2
LM613449/LM613410 AV	4.2323	107.5	3.5433	90	2.7500	69.85	0.0197	0.5	0.2717	6.9
745A/742 AV	5.7480	146.0	4.8819	124	2.7520	69.90	0.0197	0.5	0.3346	8.5
124070/124112XC AV	4.3307	110.0	3.7795	96	2.7559	70.00	0.0197	0.5	0.2638	6.7
484/472A AV	4.5866	116.5	3.8583	98	2.7559	70.00	0.0197	0.5	0.2402	6.1
484/472 AV	4.5866	116.5	3.8583	98	2.7559	70.00	0.0197	0.5	0.2402	6.1
484/472D AV	4.5866	116.5	3.8583	98	2.7559	70.00	0.0197	0.5	0.2402	6.1
JLM813049/JLM813010 AV	4.2323	107.5	3.6220	92	2.7559	70.00	0.0197	0.5	0.2244	5.7
33281/33462 AV	4.4488	113.0	3.8583	98	2.8122	71.43	0.0197	0.5	0.2717	6.9
H715345/H715311 AV	5.1969	132.0	4.3307	110	2.8122	71.43	0.0197	0.5	0.3976	10.1
645/632 AV	5.1969	132.0	4.3307	110	2.8122	71.43	0.0197	0.5	0.3976	10.1
H414249/H414210 AV	5.1969	132.0	4.3307	110	2.8122	71.43	0.0197	0.5	0.3976	10.1
29685/29620 AV	4.3307	110.0	3.7795	96	2.8748	73.02	0.0197	0.5	0.2717	6.9
33287/33462 AV	4.4488	113.0	3.8583	98	2.8748	73.02	0.0197	0.5	0.2717	6.9
33287/33461 AV	4.4488	113.0	3.8583	98	2.8748	73.02	0.0197	0.5	0.2717	6.9
567/563 AV	4.7638	121.0	4.1732	106	2.8750	73.03	0.0197	0.5	0.3346	8.5
568/563 AV	4.7638	121.0	4.1732	106	2.9062	73.82	0.0197	0.5	0.3307	8.4
JH415647/JH415610 AV	5.5906	142.0	4.7244	120	2.9528	75.00	0.0197	0.5	0.3622	9.2
JLM714149/JLM714110 AV	4.4488	113.0	3.8583	98	2.9528	75.00	0.0197	0.5	0.2441	6.2
JM714249/JM714210 AV	4.5866	116.5	3.8583	98	2.9528	75.00	0.0197	0.5	0.2441	6.2
HM215249/HM215210 AV	5.0000	127.0	4.0945	104	2.9921	76.00	0.0197	0.5	0.2953	7.5
34300/34478 AV	4.6850	119.0	3.8583	98	3.0000	76.20	0.0197	0.5	0.3031	7.7
34300/34481B AV	4.7638	121.0	4.1732	106	3.0000	76.20	0.0197	0.5	0.1457	3.7
42688/42620 AV	4.8819	124.0	4.5276	115	3.0000	76.20	0.0197	0.5	0.3346	8.5
42687/42620 AV	4.8819	124.0	4.5276	115	3.0000	76.20	0.0197	0.5	0.3346	8.5
495A/493 AV	5.1969	132.0	4.3307	110	3.0000	76.20	0.0197	0.5	0.3346	8.5
NA495SW/493D AV	5.1969	132.0	4.3307	110	3.0000	76.20	0.0197	0.5	0.3346	8.5
495AX/493 AV	5.1969	132.0	4.3307	110	3.0000	76.20	0.0197	0.5	0.3346	8.5
575/572 AV	5.3543	136.0	4.3307	110	3.0000	76.20	0.0197	0.5	0.3346	8.5
575/572X AV	5.3543	136.0	4.3307	110	3.0000	76.20	0.0197	0.5	0.3346	8.5
6576/6535 AV	6.1417	156.0	4.9213	125	3.0000	76.20	0.0197	0.5	0.4528	11.5

NILOS-Rings for taper roller bearings, inch size

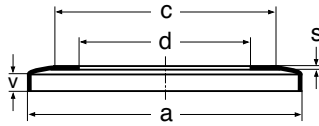
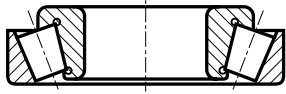

NILOS-Ring	a		c		d		s		v	
	inch	mm	inch	mm	inch	mm	inch	mm	inch	mm
6575/6535 AV	6.1417	156.0	4.9213	125	3.0000	76.20	0.0197	0.5	0.4528	11.5
659/654D AV	5.7480	146.0	4.8819	124	3.0000	76.20	0.0197	0.5	0.3976	10.1
NA659SW/654D AV	5.7480	146.0	4.8819	124	3.0000	76.20	0.0197	0.5	0.3976	10.1
659/652 AV	5.7480	146.0	4.8819	124	3.0000	76.20	0.0197	0.5	0.3976	10.1
659SW/654D AV	5.7480	146.0	4.8819	124	3.0000	76.20	0.0197	0.5	0.3976	10.1
6461/6420 AV	5.7480	146.0	4.8819	124	3.0000	76.20	0.0197	0.5	0.3976	10.1
748S/742 AV	5.7480	146.0	4.8819	124	3.0000	76.20	0.0197	0.5	0.3346	8.5
748S/742D AV	5.7480	146.0	4.8819	124	3.0000	76.20	0.0197	0.5	0.3346	8.5
755/752 AV	6.1417	156.0	4.9213	125	3.0000	76.20	0.0197	0.5	0.3976	10.1
HH221430/HH221410 AV	7.2835	185.0	6.6142	168	3.0000	76.20	0.0197	0.5	0.4567	11.6
JM612949/JM612910 AV	4.4488	113.0	3.8583	98	3.0000	76.20	0.0197	0.5	0.2441	6.2
L814749/L814710 AV	4.1929	106.5	3.8583	98	3.0000	76.20	0.0197	0.5	0.1772	4.5
5760/5735 AV	5.1969	132.0	4.3307	110	3.0020	76.25	0.0197	0.5	0.3898	9.9
LL714649/LL714610 AV	4.0551	103.0	3.7402	95	3.0020	76.25	0.0197	0.5	0.1772	4.5
42690/42620 AV	4.8819	124.0	4.5276	115	3.0622	77.78	0.0197	0.5	0.3346	8.5
495AS/493 AV	5.1969	132.0	4.3307	110	3.0622	77.78	0.0197	0.5	0.3346	8.5
HH221431/HH221410 AV	7.2835	185.0	6.6142	168	3.1252	79.38	0.0197	0.5	0.4567	11.6
578/572 AV	5.3543	136.0	4.3307	110	3.1496	80.00	0.0197	0.5	0.3346	8.5
748/743 AV	5.7480	146.0	4.8819	124	3.1496	80.00	0.0197	0.5	0.3937	10.0
JM515649/JM515610 AV	5.0000	127.0	4.0945	104	3.1496	80.00	0.0197	0.5	0.2638	6.7
496/492A AV	5.1969	132.0	4.3307	110	3.1874	80.96	0.0197	0.5	0.3346	8.5
496/493 AV	5.1969	132.0	4.3307	110	3.1874	80.96	0.0197	0.5	0.3346	8.5
496/493S AV	5.1969	132.0	4.3307	110	3.1874	80.96	0.0197	0.5	0.3346	8.5
740/742 AV	5.7480	146.0	4.8819	124	3.1874	80.96	0.0197	0.5	0.3346	8.5
27687/27620 AV	4.7638	121.0	4.1732	106	3.2500	82.55	0.0197	0.5	0.2402	6.1
47685/47620B AV	5.1969	132.0	4.3307	110	3.2500	82.55	0.0197	0.5	0.3031	7.7
47685/47620 AV	5.1969	132.0	4.3307	110	3.2500	82.55	0.0197	0.5	0.3031	7.7
47686/47620 AV	5.1969	132.0	4.3307	110	3.2500	82.55	0.0197	0.5	0.3031	7.7
495/493 AV	5.1969	132.0	4.3307	110	3.2500	82.55	0.0197	0.5	0.3307	8.4
495/492A AV	5.1969	132.0	4.3307	110	3.2500	82.55	0.0197	0.5	0.3307	8.4
580/572B AV	5.3543	136.0	4.3307	110	3.2500	82.55	0.0197	0.5	0.3346	8.5
580/572A AV	5.3543	136.0	4.3307	110	3.2500	82.55	0.0197	0.5	0.3346	8.5
580/572 AV	5.3543	136.0	4.3307	110	3.2500	82.55	0.0197	0.5	0.3346	8.5
580/572X AV	5.3543	136.0	4.3307	110	3.2500	82.55	0.0197	0.5	0.3346	8.5
663/653 AV	5.5906	142.0	4.5669	116	3.2500	82.55	0.0197	0.5	0.3976	10.1
749A/742 AV	5.7480	146.0	4.8819	124	3.2500	82.55	0.0197	0.5	0.3346	8.5
L116149/L116110 AV	4.4488	113.0	4.0551	103	3.2500	82.55	0.0197	0.5	0.1772	4.5
6559/6535 AV	6.1417	156.0	4.9213	125	3.2520	82.60	0.0197	0.5	0.4528	11.5
757/752 AV	6.1417	156.0	4.9213	125	3.2520	82.60	0.0197	0.5	0.3976	10.1
27690/27620 AV	4.7638	121.0	4.1732	106	3.2811	83.34	0.0197	0.5	0.2402	6.1
27689/27620 AV	4.7638	121.0	4.1732	106	3.2811	83.34	0.0197	0.5	0.2402	6.1
498/493B AV	5.1969	132.0	4.3307	110	3.3126	84.14	0.0197	0.5	0.3346	8.5
498/493 AV	5.1969	132.0	4.3307	110	3.3126	84.14	0.0197	0.5	0.3346	8.5
9385/9321 AV	6.4961	165.0	5.2362	133	3.3126	84.14	0.0197	0.5	0.7087	18.0
JH217249/JH217210 AV	5.7480	146.0	4.8819	124	3.3465	85.00	0.0197	0.5	0.3228	8.2
JHM516849/JHM516810 AV	5.3543	136.0	4.3307	110	3.3465	85.00	0.0197	0.5	0.3031	7.7
JM716649/JM716610 AV	5.0000	127.0	4.5669	116	3.3465	85.00	0.0197	0.5	0.2441	6.2
JM716648/JM716610 AV	5.0000	127.0	4.5669	116	3.3465	85.00	0.0197	0.5	0.2441	6.2
749/742 AV	5.7480	146.0	4.8819	124	3.3476	85.03	0.0197	0.5	0.3346	8.5
749/742A AV	5.7480	146.0	4.8819	124	3.3476	85.03	0.0197	0.5	0.3346	8.5
749/742B AV	5.7480	146.0	4.8819	124	3.3476	85.03	0.0197	0.5	0.3346	8.5
596/592A AV	5.7480	146.0	4.8819	124	3.3748	85.72	0.0197	0.5	0.3976	10.1
665/653 AV	5.5906	142.0	4.5669	116	3.3748	85.72	0.0197	0.5	0.3976	10.1
497/493 AV	5.1969	132.0	4.3307	110	3.3752	85.73	0.0197	0.5	0.3346	8.5

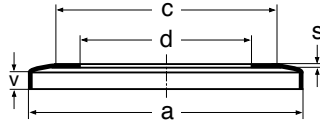
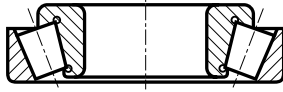

NILOS-Ring	a		c		d		s		v	
	inch	mm	inch	mm	inch	mm	inch	mm	inch	mm
497/492A AV	5.1969	132.0	4.3307	110	3.3752	85.73	0.0197	0.5	0.3346	8.5
HM617049/HM617010 AV	5.3937	137.0	4.5669	116	3.3752	85.73	0.0197	0.5	0.3622	9.2
HM617048/HM617010 AV	5.3937	137.0	4.5669	116	3.3752	85.73	0.0197	0.5	0.3622	9.2
593/592A AV	5.7480	146.0	4.8819	124	3.5000	88.90	0.0197	0.5	0.3937	10.0
6580/6535 AV	6.1417	156.0	4.9213	125	3.5000	88.90	0.0197	0.5	0.4567	11.6
6580/6536 AV	6.1417	156.0	4.9213	125	3.5000	88.90	0.0197	0.5	0.4567	11.6
759/752 AV	6.1417	156	4.9213	125	3.5000	88.90	0.0197	0.5	0.3976	10.1
NA759SW/752D AV	6.1417	156	4.9213	125	3.5000	88.90	0.0197	0.5	0.3976	10.1
759/753X AV	6.1417	156	4.9213	125	3.5000	88.90	0.0197	0.5	0.3976	10.1
77350/77675 AV	6.4961	165	5.2362	133	3.5000	88.90	0.0197	0.5	0.3976	10.1
775/772 AV	6.8898	175	5.8268	148	3.5000	88.90	0.0197	0.5	0.3976	10.1
850/832 AV	6.3386	161	5.5118	140	3.5000	88.90	0.0197	0.5	0.5197	13.2
855/854 AV	7.2835	185	6.6142	168	3.5000	88.90	0.0197	0.5	0.5197	13.2
98350/98788 AV	7.6772	195	6.8898	175	3.5000	88.90	0.0197	0.5	0.7205	18.3
L217849/L217810 AV	4.7638	121	4.2913	109	3.5000	88.90	0.0197	0.5	0.1772	4.5
LL217849/LL217810 AV	4.6850	119	4.2913	109	3.5000	88.90	0.0197	0.5	0.1772	4.5
LM117949/LM117910 AV	5.0000	127	4.5669	116	3.5000	88.90	0.0197	0.5	0.1457	3.7
NA596SW/592D AV	5.7480	146	4.8819	124	3.5000	88.90	0.0197	0.5	0.5827	14.8
42350/42587 AV	5.7480	146	4.8819	124	3.5020	88.95	0.0197	0.5	0.3031	7.7
593/592 AV	5.7480	146	4.8819	124	3.5020	88.95	0.0197	0.5	0.2717	6.9
593A/592 AV	5.7480	146	4.8819	124	3.5020	88.95	0.0197	0.5	0.2717	6.9
6581X/6525X AV	6.1417	156	4.9213	125	3.5433	90.00	0.0197	0.5	0.3937	10.0
69354/69630 AV	6.1417	156	4.9213	125	3.5433	90.00	0.0197	0.5	0.3307	8.4
HM218248/HM218210 AV	5.5906	142	4.7244	120	3.5433	90.00	0.0197	0.5	0.3150	8.0
JHH221436/JHH221413 AV	7.2835	185	6.6142	168	3.5433	90.00	0.0197	0.5	0.4567	11.6
JHM318448/JHM318410 AV	6.0236	153	5.1969	132	3.5433	90.00	0.0197	0.5	0.3425	8.7
JM718149/JM718110 AV	5.5906	142	4.8031	122	3.5433	90.00	0.0197	0.5	0.3228	8.2
598/592A AV	5.7480	146	4.8819	124	3.6248	92.07	0.0197	0.5	0.3976	10.1
598X/592A AV	5.7480	146	4.8819	124	3.6248	92.07	0.0197	0.5	0.3976	10.1
857/854 AV	7.2835	185	6.6142	168	3.6248	92.07	0.0197	0.5	0.5197	13.2
JL819349/JL819310 AV	5.1969	132	4.8425	123	3.7402	95.00	0.0197	0.5	0.2559	6.5
JM719149/JM719113 AV	5.7480	146	4.8819	124	3.7402	95.00	0.0197	0.5	0.3228	8.2
42375/42584 AV	5.7480	146	4.8819	124	3.7500	95.25	0.0197	0.5	0.3031	7.7
42376/42587 AV	5.7480	146	4.8819	124	3.7500	95.25	0.0197	0.5	0.3031	7.7
47896/47820 AV	5.5906	142	4.7244	120	3.7500	95.25	0.0197	0.5	0.3031	7.7
52375/52618 AV	6.0236	153	5.1969	132	3.7500	95.25	0.0197	0.5	0.4252	10.8
594A/592A AV	5.7480	146	4.8819	124	3.7500	95.25	0.0197	0.5	0.3976	10.1
594/592D AV	5.7480	146	4.8819	124	3.7500	95.25	0.0197	0.5	0.3976	10.1
594A/592D AV	5.7480	146	4.8819	124	3.7500	95.25	0.0197	0.5	0.3976	10.1
77375/77676X AV	6.4961	165	5.2362	133	3.7500	95.25	0.0197	0.5	0.3976	10.1
L319249/L319210 AV	5.0000	127	4.5669	116	3.7500	95.25	0.0197	0.5	0.1772	4.5
LL319349/LL319310 AV	4.8819	124	4.5276	115	3.7500	95.25	0.0197	0.5	0.1772	4.5
NA776SW/774D AV	6.8898	175	5.8268	148	3.7500	95.25	0.0197	0.5	0.3976	10.1
683/672 AV	6.3386	161	5.5118	140	3.7520	95.30	0.0197	0.5	0.4567	11.6
864/854 AV	7.2835	185	6.6142	168	3.7520	95.30	0.0197	0.5	0.5197	13.2
42381/42584 AV	5.7480	146	4.8819	124	3.8126	96.84	0.0197	0.5	0.3031	7.7
779/772 AV	6.8898	175	5.8268	148	3.8748	98.42	0.0197	0.5	0.3976	10.1
866/854 AV	7.2835	185	6.6142	168	3.8752	98.43	0.0197	0.5	0.5197	13.2
HH221442/HH221410 AV	7.2835	185	6.6142	168	3.8768	98.47	0.0197	0.5	0.4567	11.6
HH221447/HH221410 AV	7.2835	185	6.6142	168	3.9363	99.98	0.0197	0.5	0.4567	11.6
HH221447/HH221413 AV	7.2835	185	6.6142	168	3.9363	99.98	0.0197	0.5	0.4567	11.6
HM220149/HM220110 AV	6.0236	153	5.1969	132	3.9370	100.00	0.0197	0.5	0.3346	8.5
JHM720249/JHM720210 AV	6.1417	156	5.4331	138	3.9370	100.00	0.0197	0.5	0.3622	9.2
JM720249/JM720210 AV	6.0236	153	5.1969	132	3.9370	100.00	0.0197	0.5	0.3228	8.2

NILOS-Rings for taper roller bearings, inch size

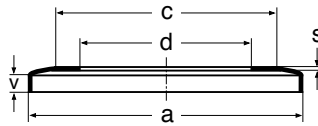

NILOS-Ring	a		c		d		s		v	
	inch	mm	inch	mm	inch	mm	inch	mm	inch	mm
JP10049/JP10010 AV	5.5906	142	4.8031	122	3.9370	100.00	0.0197	0.5	0.2756	7.0
52400/52618 AV	6.0236	153	5.1969	132	4.0000	101.60	0.0197	0.5	0.4252	10.8
52400/52637 AV	6.0236	153	5.1969	132	4.0000	101.60	0.0197	0.5	0.4252	10.8
52400/52637D AV	6.0236	153	5.1969	132	4.0000	101.60	0.0197	0.5	0.4252	10.8
52401/52618 AV	6.0236	153	5.1969	132	4.0000	101.60	0.0197	0.5	0.4252	10.8
687/672 AV	6.3386	161	5.5118	140	4.0000	101.60	0.0197	0.5	0.4606	11.7
NA691/672 AV	6.3386	161	5.5118	140	4.0000	101.60	0.0197	0.5	0.4606	11.7
780/772 AV	6.8898	175	5.8268	148	4.0000	101.60	0.0197	0.5	0.3976	10.1
780/772B AV	6.8898	175	5.8268	148	4.0000	101.60	0.0197	0.5	0.3976	10.1
861/854D AV	7.2835	185	6.6142	168	4.0000	101.60	0.0197	0.5	0.5197	13.2
861/854 AV	7.2835	185	6.6142	168	4.0000	101.60	0.0197	0.5	0.5197	13.2
98400/98788 AV	7.6772	195	6.8898	175	4.0000	101.60	0.0197	0.5	0.7205	18.3
HH221449/HH221410 AV	7.2835	185	6.6142	168	4.0000	101.60	0.0197	0.5	0.4567	11.6
L420449/L420410 AV	5.1969	132	4.8425	123	4.0000	101.60	0.0197	0.5	0.2087	5.3
LL420549/LL420510 AV	5.1969	132	4.8425	123	4.0000	101.60	0.0197	0.5	0.1772	4.5
LM720648/LM720610 AV	5.5906	142	5.1181	130	4.0000	101.60	0.0197	0.5	0.2717	6.9
67389/67320 AV	7.6772	195	6.8898	175	4.0622	103.18	0.0197	0.5	0.3346	8.5
782/772B AV	6.8898	175	5.8268	148	4.1248	104.77	0.0197	0.5	0.3976	10.1
782/772 AV	6.8898	175	5.8268	148	4.1248	104.77	0.0197	0.5	0.3976	10.1
NA782/773D AV	6.8898	175	5.8268	148	4.1248	104.77	0.0197	0.5	0.3976	10.1
782/774 AV	6.8898	175	5.8268	148	4.1248	104.77	0.0197	0.5	0.3976	10.1
71412/71750 AV	7.2835	185	6.6142	168	4.1268	104.82	0.0197	0.5	0.5197	13.2
37425/37625 AV	6.0236	153	5.1969	132	4.2500	107.95	0.0197	0.5	0.3031	7.7
48190/48120 AV	6.1417	156	5.4331	138	4.2500	107.95	0.0197	0.5	0.3346	8.5
56425/56650 AV	6.3386	161	5.5118	140	4.2500	107.95	0.0197	0.5	0.3976	10.1
71750/71425 AV	7.2835	185	6.6142	168	4.2500	107.95	0.0197	0.5	0.5197	13.2
HH224340/HH224310 AV	8.2677	210	7.0079	178	4.2500	107.95	0.0197	0.5	0.5197	13.2
LM522546/LM522510 AV	6.1417	156	5.4331	138	4.2500	107.95	0.0197	0.5	0.3346	8.5
NA56425SW/56650D AV	6.3386	161	5.5118	140	4.2500	107.95	0.0197	0.5	0.5157	13.1
NA56425SW/56650 AV	6.3386	161	5.5118	140	4.2500	107.95	0.0197	0.5	0.5157	13.1
56425/566520 AV	6.3386	161	5.5118	140	4.2500	107.95	0.0197	0.5	0.5157	13.1
37431/37625 AV	6.0236	153	5.1969	132	4.3142	109.58	0.0197	0.5	0.3031	7.7
LM522549/LM522510 AV	6.1417	156	5.4331	138	4.3302	109.99	0.0197	0.5	0.3346	8.5
64433/64700 AV	6.8898	175	5.8268	148	4.3304	109.99	0.0197	0.5	0.4567	11.6
JHM522649/JHM522610 AV	6.8898	175	5.8268	148	4.3307	110.00	0.0197	0.5	0.3622	9.2
JM822049/JM822010 AV	6.3386	161	5.5118	140	4.3307	110.00	0.0197	0.5	0.3425	8.7
67675/67437 AV	6.6142	168	5.5906	142	4.3748	111.12	0.0197	0.5	0.3661	9.3
71750/71437 AV	7.2835	185	6.6142	168	4.3748	111.12	0.0197	0.5	0.5197	13.2
64450/64700 AV	6.8898	175	5.8268	148	4.5000	114.30	0.0197	0.5	0.4567	11.6
64450/64701X AV	6.8898	175	5.8268	148	4.5000	114.30	0.0197	0.5	0.4567	11.6
68450/68712 AV	6.8898	175	5.8268	148	4.5000	114.30	0.0197	0.5	0.3976	10.1
71750/71450 AV	7.2835	185	6.6142	168	4.5000	114.30	0.0197	0.5	0.5197	13.2
NA71450/71751D AV	7.2835	185	6.6142	168	4.5000	114.30	0.0197	0.5	0.5197	13.2
938/932 AV	7.6772	195	6.8898	175	4.5000	114.30	0.0197	0.5	0.5197	13.2
NA938/932D AV	7.6772	195	6.8898	175	4.5000	114.30	0.0197	0.5	0.5197	13.2
HH224346/HH224310AV	8.2677	210	7.0079	178	4.5000	114.30	0.0197	0.5	0.5197	13.2
HH224346/HH224310D AV	8.2677	210	7.0079	178	4.5000	114.30	0.0197	0.5	0.5197	13.2
L623149/L623110 AV	5.7874	147	5.3150	135	4.5000	114.30	0.0197	0.5	0.2087	5.3
68462/68712 AV	6.8898	175	5.8268	148	4.6250	117.48	0.0197	0.5	0.3937	10.0
68462/68709 AV	6.8898	175	5.8268	148	4.6250	117.48	0.0197	0.5	0.3937	10.0
L724348/L724314 AV	6.4961	165	5.6299	143	4.7240	119.99	0.0197	0.5	0.2677	6.8
JM624649/JM624610 AV	6.8898	175	5.8268	148	4.7244	120.00	0.0197	0.5	0.4134	10.5
795/792 AV	7.6772	195	6.8898	175	4.7500	120.65	0.0197	0.5	0.5197	13.2
95475/95925 AV	9.0551	230	8.4252	214	4.7500	120.65	0.0197	0.5	0.5827	14.8

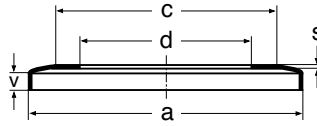
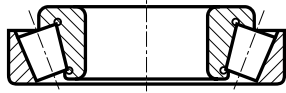

NILOS-Ring	a		c		d		s		v	
	inch	mm	inch	mm	inch	mm	inch	mm	inch	mm
48286/48220 AV	7.0079	178	6.2992	160	4.8750	123.83	0.0197	0.5	0.2717	6.9
48290/48220 AV	7.0079	178	6.2992	160	5.0000	127.00	0.0197	0.5	0.2717	6.9
67388/67320 AV	7.6772	195	6.8898	175	5.0000	127.00	0.0197	0.5	0.3346	8.5
74500/74850 AV	8.2677	210	7.0079	178	5.0000	127.00	0.0197	0.5	0.5197	13.2
95500/95925 AV	9.0551	230	8.4252	214	5.0000	127.00	0.0197	0.5	0.5827	14.8
NA95500/95927D AV	9.0551	230	8.4252	214	5.0000	127.00	0.0197	0.5	0.5827	14.8
95500/95927D AV	9.0551	230	8.4252	214	5.0000	127.00	0.0197	0.5	0.5827	14.8
97500/97900 AV	8.6614	220	7.0079	178	5.0000	127.00	0.0197	0.5	0.6457	16.4
HH228349/HH228310 AV	9.6457	245	8.6614	220	5.0000	127.00	0.0197	0.5	0.6457	16.4
L725349/L725311 AV	6.6142	168	6.1024	155	5.0000	127.00	0.0197	0.5	0.2992	7.6
NA48290SW/48220D AV	7.0079	178	6.2992	160	5.0000	127.00	0.0197	0.5	0.4252	10.8
HM926747/HM926710 AV	8.8583	225	8.4646	215	5.0020	127.05	0.0197	0.5	0.6457	16.4
HM926749/HM926710 AV	8.8583	225	8.4646	215	5.0331	127.84	0.0197	0.5	0.6457	16.4
48385/48320 AV	7.2835	185	6.6142	168	5.2500	133.35	0.0197	0.5	0.2717	6.9
67390/67322 AV	7.6772	195	6.8898	175	5.2500	133.35	0.0197	0.5	0.3346	8.5
67391/67322 AV	7.6772	195	6.8898	175	5.2500	133.35	0.0197	0.5	0.3346	8.5
74525/74850 AV	8.2677	210	7.0079	178	5.2500	133.35	0.0197	0.5	0.5197	13.2
NA74525/74851 AV	8.2677	210	7.0079	178	5.2500	133.35	0.0197	0.5	0.5197	13.2
74525/74851 AV	8.2677	210	7.0079	178	5.2500	133.35	0.0197	0.5	0.5197	13.2
95528/95925 AV	9.0551	230	8.4252	214	5.2500	133.35	0.0197	0.5	0.5827	14.8
48393/48320 AV	7.2835	185	6.6142	168	5.3748	136.52	0.0197	0.5	0.2717	6.9
74537/74850 AV	8.2677	210	7.0079	178	5.3748	136.52	0.0197	0.5	0.5197	13.2
74537/74850B AV	8.2677	210	7.0079	178	5.3748	136.52	0.0197	0.5	0.5197	13.2
896/892 AV	8.6614	220	7.0079	178	5.3768	136.57	0.0197	0.5	0.5197	13.2
74550/74850 AV	8.2677	210	7.0079	178	5.5000	139.70	0.0197	0.5	0.5197	13.2
898/892 AV	8.6614	220	7.0079	178	5.5000	139.70	0.0197	0.5	0.5197	13.2
898/892B AV	8.6614	220	7.0079	178	5.5000	139.70	0.0197	0.5	0.5197	13.2
899/892 AV	8.6614	220	7.0079	178	5.5000	139.70	0.0197	0.5	0.5197	13.2
99550/99100 AV	9.6457	245	8.6614	220	5.5000	139.70	0.0197	0.5	0.7795	19.8
99600/99098X AV	9.6457	245	8.6614	220	5.5000	139.70	0.0197	0.5	0.7795	19.8
LM328448/LM328410 AV	7.2835	185	6.6142	168	5.5000	139.70	0.0197	0.5	0.2402	6.1
48685/48620 AV	7.6772	195	6.8898	175	5.6248	142.87	0.0197	0.5	0.3031	7.7
48684/48620 AV	7.6772	195	6.8898	175	5.6248	142.87	0.0197	0.5	0.3031	7.7
NA48685SW/48620D AV	7.6772	195	6.8898	175	5.6248	142.87	0.0197	0.5	0.4252	10.8
82576/82931 AV	9.0551	230	8.4252	214	5.7500	146.05	0.0197	0.5	0.5197	13.2
HM231140/HM231110 AV	9.0551	230	8.4252	214	5.7500	146.05	0.0197	0.5	0.5197	13.2
82576/82950 AV	9.0551	230	8.4252	214	5.7500	146.05	0.0197	0.5	0.5197	13.2
36690/36620 AV	7.4409	189	6.8898	175	5.7520	146.10	0.0197	0.5	0.2402	6.1
36690/36620D AV	7.4409	189	6.8898	175	5.7520	146.10	0.0197	0.5	0.2402	6.1
99600/99100 AV	9.6457	245	8.6614	220	6.0000	152.40	0.0197	0.5	0.7795	19.8
HH234048/HH234010 AV	11.5748	294	10.0394	255	6.0000	152.40	0.0197	0.5	0.8937	22.7
M231649/M231610D AV	8.6614	220	7.7953	198	6.0000	152.40	0.0197	0.5	0.4921	12.5
M231649/M231610 AV	8.6614	220	7.7953	198	6.0000	152.40	0.0197	0.5	0.4921	12.5
46780/46720 AV	8.6614	220	7.7953	198	6.2500	158.75	0.0197	0.5	0.3346	8.5
L432349/L432310 AV	7.8740	200	7.2835	185	6.2520	158.80	0.0197	0.5	0.2362	6.0
HM237532/HM237510 AV	11.0236	280	10.0394	255	6.3122	160.33	0.0197	0.5	0.6457	16.4
46790/46720 AV	8.6614	220	7.7953	198	6.5000	165.10	0.0197	0.5	0.3346	8.5
67780/67720 AV	9.6457	245	8.6614	220	6.5000	165.10	0.0197	0.5	0.3976	10.1
94649/94113 AV	11.0236	280	10.0394	255	6.5000	165.10	0.0197	0.5	0.6457	16.4
HM237535/HM237510D AV	11.0236	280	10.0394	255	6.5000	165.10	0.0197	0.5	0.6457	16.4
HM237535/HM237510 AV	11.0236	280	10.0394	255	6.5000	165.10	0.0197	0.5	0.6457	16.4
94650/94113 AV	11.0236	280	10.0394	255	6.5000	165.10	0.0197	0.5	0.6457	16.4
NA46790SW/46720D AV	8.6614	220	7.7953	198	6.5000	165.10	0.0197	0.5	0.5157	13.1
86669/86100 AV	9.6457	245	8.6614	220	6.6929	170.00	0.0197	0.5	0.5197	13.2

NILOS-Rings for taper roller bearings, inch size

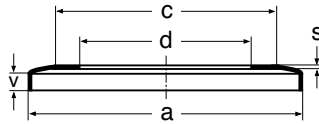
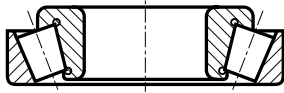

NILOS-Ring	a		c		d		s		v	
	inch	mm	inch	mm	inch	mm	inch	mm	inch	mm
JHM534149/JHM534110 AV	8.8583	225	8.4646	215	6.6929	170.00	0.0197	0.5	0.3268	8.3
JM734449/JM734410 AV	9.3307	237	8.6614	220	6.6929	170.00	0.0197	0.5	0.3661	9.3
JP17049/JP17010 AV	8.8583	225	8.4646	215	6.6929	170.00	0.0197	0.5	0.3661	9.3
HM535349/HM535310 AV	10.0394	255	9.2520	235	6.7500	171.45	0.0197	0.5	0.5827	14.8
94675/94113 AV	11.0236	280	10.0394	255	6.7520	171.50	0.0197	0.5	0.6457	16.4
67790/67720B AV	9.6457	245	8.6614	220	7.0000	177.80	0.0197	0.5	0.3976	10.1
67790/67720 AV	9.6457	245	8.6614	220	7.0000	177.80	0.0197	0.5	0.3976	10.1
NA67791/67720AV	9.6457	245	8.6614	220	7.0000	177.80	0.0197	0.5	0.3976	10.1
NA67791SW/67720D AV	9.6457	245	8.6614	220	7.0000	177.80	0.0197	0.5	0.3976	10.1
67791/67720 AV	9.6457	245	8.6614	220	7.0000	177.80	0.0197	0.5	0.3976	10.1
94700/94113 AV	11.0236	280	10.0394	255	7.0000	177.80	0.0197	0.5	0.6457	16.4
HM237545/HM237510 AV	11.0236	280	10.0394	255	7.0000	177.80	0.0197	0.5	0.6457	16.4
94700/94114 AV	11.0236	280	10.0394	255	7.0000	177.80	0.0197	0.5	0.6457	16.4
94700/94114D AV	11.0236	280	10.0394	255	7.0000	177.80	0.0197	0.5	0.6457	16.4
JM736149/JM736110 AV	9.6457	245	8.6614	220	7.0866	180.00	0.0197	0.5	0.4055	10.3
LL537649/LL537610 AV	9.0551	230	8.4252	214	7.2500	184.15	0.0197	0.5	0.3031	7.7
LM236749/LM236710 AV	9.0551	230	8.4252	214	7.2500	184.15	0.0197	0.5	0.2559	6.5
67884/67835 AV	11.0236	280	10.0394	255	7.3768	187.37	0.0197	0.5	0.4331	11.0
JM738249/JM738210 AV	10.0394	255	9.2520	235	7.4803	190.00	0.0197	0.5	0.3858	9.8
67885/67820 AV	10.2362	260	9.2913	236	7.5000	190.50	0.0197	0.5	0.3976	10.1
93750/93125 AV	11.8110	300	10.2362	260	7.5000	190.50	0.0197	0.5	0.7087	18.0
NA67885SW/67820D AV	10.2362	260	9.2913	236	7.5000	190.50	0.0197	0.5	0.5197	13.2
LL639249/LL639210 AV	9.3307	237	8.6614	220	7.7520	196.90	0.0197	0.5	0.2717	6.9
LM739749/LM739710 AV	9.9213	252	9.2520	235	7.7520	196.90	0.0197	0.5	0.3976	10.1
LM739749/LM739719 AV	10.0394	255	9.2520	235	7.7520	196.90	0.0197	0.5	0.3976	10.1
JHM840449/JHM840410 AV	11.5748	294	10.0394	255	7.8740	200.00	0.0197	0.5	0.5630	14.3
67983/67920B AV	11.0236	280	9.6457	245	8.0000	203.20	0.0197	0.5	0.3937	10.0
93800/93125 AV	11.8110	300	10.2362	260	8.0000	203.20	0.0197	0.5	0.7087	18.0
67985/67920B AV	11.0236	280	9.6457	245	8.1248	206.37	0.0197	0.5	0.3937	10.0
93825/93125 AV	11.8110	300	10.2362	260	8.2520	209.60	0.0197	0.5	0.7087	18.0
93825/93127D AV	12.2047	310	10.6299	270	8.2520	209.60	0.0197	0.5	0.7205	18.3
LM742749/LM742710B AV	11.0236	280	10.0394	255	8.5000	215.90	0.0197	0.5	0.4567	11.6
M244249/M244210 AV	12.2047	310	10.6299	270	8.6875	220.66	0.0197	0.5	0.5197	13.2
M249734/M249710 AV	13.7795	350	12.2047	310	9.0000	228.60	0.0276	0.7	0.7087	18.0
88925/88128 AV	12.2047	310	10.6299	270	9.2500	234.95	0.0197	0.5	0.7047	17.9
M246949/M246910 AV	12.9921	330	11.4173	290	9.3465	237.40	0.0197	0.5	0.5827	14.8
M249736/M249710 AV	13.7795	350	12.2047	310	9.3465	237.40	0.0276	0.7	0.7087	18.0
M249749/M249710 AV	13.7795	350	12.2047	310	10.0000	254.00	0.0276	0.7	0.7087	18.0
M249749/M249710D AV	13.7795	350	12.2047	310	10.0000	254.00	0.0276	0.7	0.7087	18.0
K38880/K38820 AV	12.5197	318	12.0472	306	10.3760	263.55	0.0197	0.5	0.1457	3.7
L853049/L853010 AV	13.7795	350	12.2047	310	10.8752	276.23	0.0197	0.5	0.5197	13.2

SKF USA Inc.
800-541-3624
www.skfusa.com/NILOSrings



- ® SKF is a registered trademark of SKF USA Inc.
- ® Seeger is a registered trademark of Seeger-Orbis, an Associated Spring Company.
- ® NILOS-Ring is a registered trademark of Ziller GmbH & Co. KG

The contents of this publication are the copyright of the publisher and may not be reproduced (even extracts) unless permission is granted. Every care has been taken to ensure the accuracy of the information contained in this publication but no liability can be accepted for any loss or damage whether direct, indirect or consequential arising out of use of the information contained herein.

© 2003 SKF USA Inc.

Publication 950-710

(3M/AN 10/2008)

Version 10/2008

Printed in U.S.A.

