

**SEALMASTER**<sup>®</sup>

# HF & HFT

## High Temperature Furnace Bearings



A Regal Brand

**REGAL**

## Sealmaster® High Temperature Furnace Bearings

All Sealmaster bearings are designed and manufactured to high quality and performance standards. However, not all bearings are suitable for highly specialized applications, such as high operating temperatures. These applications are unique and require enhanced designed features not available on standard or factory modified units.

### High Temperature Bearings... The Design and Application Parameters

After extensive research into various market segments and industries, Sealmaster bearing engineers have developed a uniquely designed ball bearing series that is well matched to these high temperature applications. To support proper selection for those severe services, consider these basic application parameters:

#### Temperature

A high temperature bearing is designed to operate in ambient temperatures up to 400° F (200°C). Standard bearings (or slightly modified bearings) are not designed to operate in temperatures much above 200° F (100°C).

### Contents:

|   |    |
|---|----|
| Design and Application Parameters .....               | 2  |
| Temperature .....                                     | 2  |
| Application .....                                     | 3  |
| Features .....  | 3  |
| Lubrication System .....                              | 3  |
| Details of Parts .....                                | 4  |
| Four Bolt Flange Units .....                          | 6  |
| Two Bolt Flange Units .....                           | 7  |
| Non-Expansion Bearing Installation Instructions ..... | 8  |
| Expansion Bearing Installation Instructions .....     | 9  |
| Shaft Growth Calculation .....                        | 10 |
| Lubrication Information .....                         | 11 |



---

## Application

These bearings support conveyor rolls that are designed to transport a variety of materials through industrial furnaces or ovens. Generally, they are operated at slow speeds (up to 800 RPM). These bearings are usually located on the outside of the furnace/oven with the shaft extending through the heated area. In a rare instance, bearings are located inside the furnace or oven. Typical applications include:

- Heat treat equipment
- Kilns, curing furnaces, etc.
- Food processing conveyors (bakeries, etc.)

## Features

Sealmaster Series HF and HFT high temperature bearings have been engineered to meet the special requirements of industrial furnace/oven applications, and they incorporate several unique design features. Bearings are offered in both fixed and float unit arrangements. Note: It is highly recommended that furnace applications utilize a fixed and float bearing arrangement to accept the axial shaft expansion encountered at elevated operating temperatures. Bearings are standard with increased internal clearances to allow for inner/outer ring expansion from elevated operating temperatures. Bearings incorporate specialized sealing arrangements and two types of steel end caps, which act in tandem to help prevent the hot furnace gases from escaping through the bearing-shaft interface. Both caps, rugged in design, bolt directly onto the face of the bearing casting.

**HEC (Expansion) Closed End Cap** – designed to be installed on the non-drive side of the shaft; cap arrangement also allows for shaft expansion (see page 4)

**HFC (Fixed) Open End Cap** – designed to be installed on the through shaft, driven side.

A VITON\* V-ring seal is included with the (HFC) open end cap which helps to seal off furnace gases and retain the lubricant within the bearings. Users concerned with facility cleanliness will especially appreciate this end cap/seal design.

## Customized lubrication system for optimal bearing performance.

All bearings are supplied with a high quality / high temperature synthetic lubricant selected to provide reliable operation at temperatures up to 400°F (200°C). For optimum bearing life relubrication is strongly recommended. As in many cases, experience will determine the best relubrication interval for each specific application. The units are equipped with two pipe plugs inserted into two drilled and tapped holes in the casting located 180° from each other. This allows the user to remove the pipe plugs and add pipe extensions or lube lines in order to add additional lubricant to the top hole while purging (draining, forcing out) old lubricant out of the bottom hole. Contact bearing application engineering for specific lubrication recommendations at 1-800-626-2120 or email to: [ApplicationEngineering.PTSolutions@regalbeloit.com](mailto:ApplicationEngineering.PTSolutions@regalbeloit.com)

*\* VITON is believed to be the trademark and/or trade name of The Chemours Company FC, and is not owned or controlled by Regal Beloit America, Inc.*

## Details of Parts

### Relubrication Hole Plugs

The units are equipped with two pipe plugs in the lubrication holes in the housing. Remove the plugs and attach pipe extensions or lube lines in order to add fresh lubricant to the unit.



### Retainer

Brass land riding retainer helps to improve lubrication circulation compared to ball riding retainers and provides proper ball retention at elevated temperatures (brass has a melting point of 1250°F).

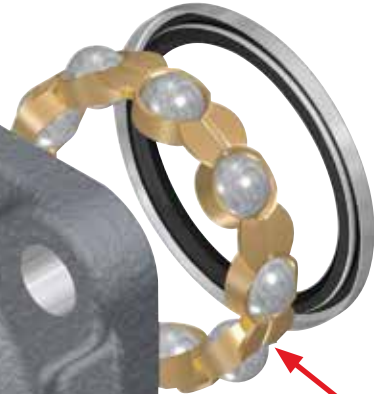

### High Temperature Seals

High Temperature HeatGard Ultra Seals withstand the severe operating environment and help retain lubricant within the bearing chamber.



### Lock Pin

Key to the design of the Sealmaster HF/HFT Furnace Bearings is a specified anti-rotation lock nut, which helps to prevent outer ring "creep".

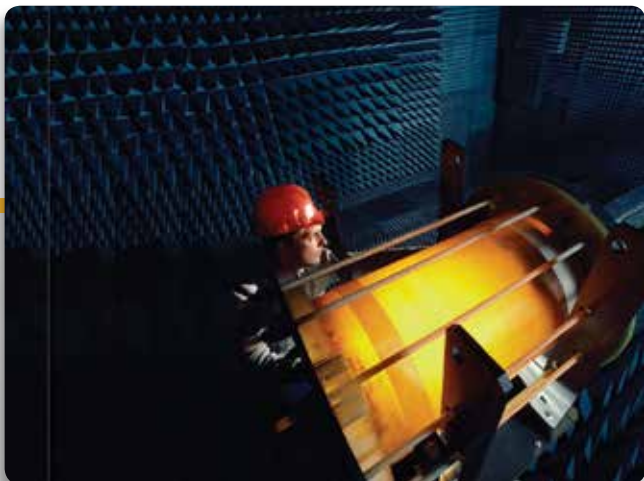



**V-Ring Seal**

The VITON\* V-ring seal, included with the (HFC) open end cap, helps to seal off furnace gases and retain the lubricant within the bearing. V-ring supplied with open end cap.

**Open End Caps (Fixed)**

HFC caps have an opening to allow the shaft to pass through to the customer's drive system. End caps must be ordered separately.



**Closed End Caps (Expansion)**

HEC caps are closed, which when used with a square head setscrew (supplied with the cap) and a customer machined keyway in the shaft, allows the shaft to expand axially through the bore of the bearing when the shaft temperature rises. End caps must be ordered separately.

**Square Head Setscrew**

Closed end caps utilize a square head setscrew that fits into a machined keyway in the shaft to allow the shaft to expand axially through the bore.

\* VITON is believed to be the trademark and/or trade name of The Chemours Company FC, and is not owned or controlled by Regal Beloit America, Inc.

## HF Series High Temperature Four Bolt Flange Units

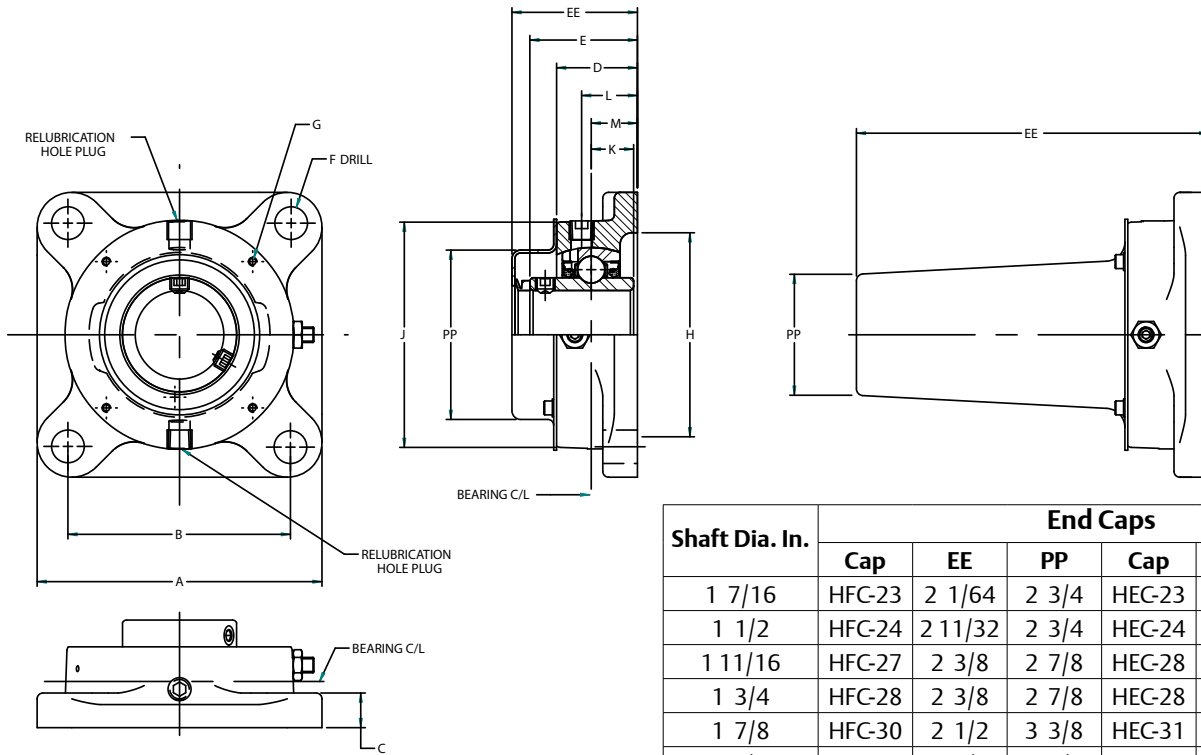

| Shaft Dia. In. | End Caps |         |       |        |         |         |
|----------------|----------|---------|-------|--------|---------|---------|
|                | Cap      | EE      | PP    | Cap    | EE      | PP      |
| 1 7/16         | HFC-23   | 2 1/64  | 2 3/4 | HEC-23 | 5 23/32 | 1 31/32 |
| 1 1/2          | HFC-24   | 2 11/32 | 2 3/4 | HEC-24 | 5 15/32 | 1 13/16 |
| 1 11/16        | HFC-27   | 2 3/8   | 2 7/8 | HEC-28 | 5 17/32 | 2 1/16  |
| 1 3/4          | HFC-28   | 2 3/8   | 2 7/8 | HEC-28 | 5 17/32 | 2 1/16  |
| 1 7/8          | HFC-30   | 2 1/2   | 3 3/8 | HEC-31 | 5 17/32 | 2 17/64 |
| 1 15/16        | HFC-31   | 2 1/2   | 3 3/8 | HEC-31 | 5 17/32 | 2 17/64 |

| Dimensions in Inches |          |         |       |       |      |         |        |       |       |        |        |       |        |       |
|----------------------|----------|---------|-------|-------|------|---------|--------|-------|-------|--------|--------|-------|--------|-------|
| Shaft Dia. In.       | Part No. | Brg No. | A SQ. | B     | C    | D       | E      | F     | G UNF | H Core | J      | K     | L      | M     |
| 1 7/16               | HF-23    | HT-23   | 4 5/8 | 3 5/8 | 9/16 | 1 5/16  | 1 3/4  | 17/32 | 6-32  | 3 5/16 | 3 3/4  | 11/16 | 29/32  | 3/4   |
| 1 1/2                | HF-24    | HT-24   | 5 1/8 | 4     | 9/16 | 1 15/32 | 2 1/64 | 17/32 | 10-24 | 3 1/2  | 4 1/8  | 3/4   | 1 1/32 | 53/64 |
| 1 11/16              | HF-27    | HT-27   | 5 3/8 | 4 1/8 | 9/16 | 1 17/32 | 2 3/64 | 19/32 | 10-24 | 3 7/8  | 4 3/8  | 3/4   | 1 1/16 | 55/64 |
| 1 3/4                | HF-28    | HT-28   | 5 3/8 | 4 1/8 | 9/16 | 1 17/32 | 2 3/64 | 19/32 | 10-24 | 3 7/8  | 4 3/8  | 3/4   | 1 1/16 | 55/64 |
| 1 7/8                | HF-30    | HT-30   | 5 5/8 | 4 3/8 | 9/16 | 1 17/32 | 2 5/32 | 19/32 | 10-24 | 4      | 4 9/16 | 3/4   | 1 5/32 | 7/8   |
| 1 15/16              | HF-31    | HT-31   | 5 5/8 | 4 3/8 | 9/16 | 1 17/32 | 2 5/32 | 19/32 | 10-24 | 4      | 4 9/16 | 3/4   | 1 5/32 | 7/8   |

\* End Caps sold separately



HF-23



HF-23 HFC CAP



HF-23 HEC CAP

# HFT Series High Temperature Two Bolt Flange Units

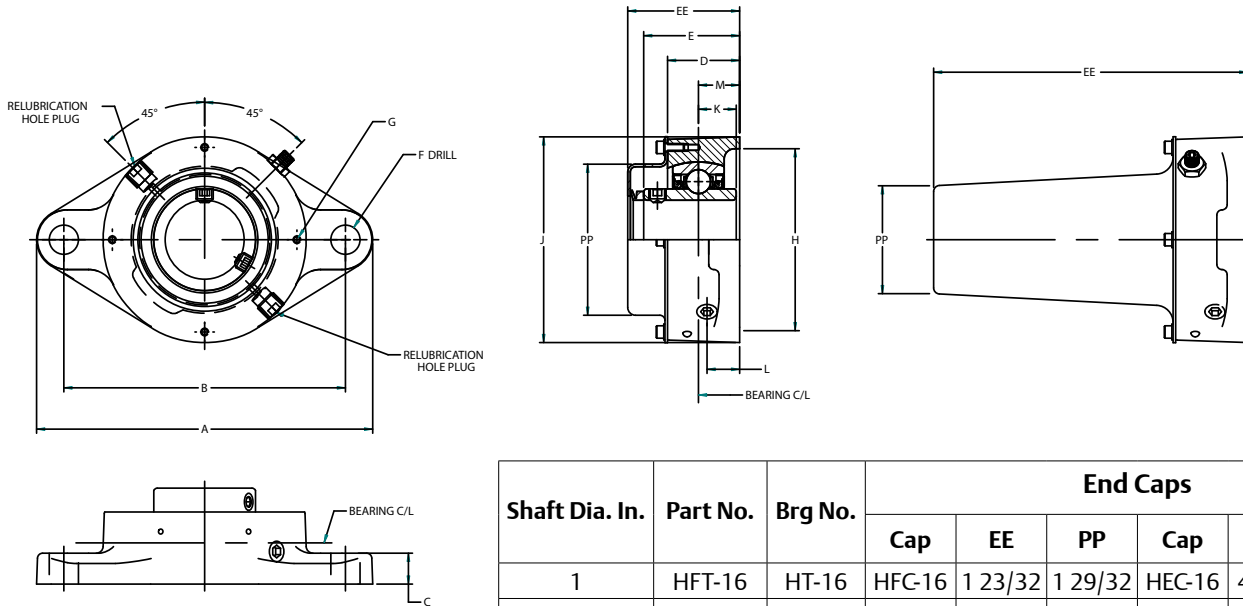

| Shaft Dia. In. | Part No. | Brg No. | End Caps |         |         |        |         |         |
|----------------|----------|---------|----------|---------|---------|--------|---------|---------|
|                |          |         | Cap      | EE      | PP      | Cap    | EE      | PP      |
| 1              | HFT-16   | HT-16   | HFC-16   | 1 23/32 | 1 29/32 | HEC-16 | 4 7/32  | 1 7/16  |
| 1 3/16         | HFT-19   | HT-19   | HFC-19   | 1 27/32 | 2 3/8   | HEC-19 | 4 63/64 | 1 45/64 |
| 1 1/4R         | HFT-20R  | HT-20R  | HFC-20R  | 1 27/32 | 2 3/8   | HEC-19 | 4 63/64 | 1 45/64 |
| 1 7/16         | HFT-23   | HT-23   | HFC-23   | 2 3/64  | 2 3/4   | HEC-23 | 5 23/32 | 1 31/32 |
| 1 1/2          | HFT-24   | HFT-24  | HFC-24   | 2 11/32 | 2 3/4   | HEC-24 | 5 15/32 | 1 13/16 |

| Dimensions in Inches |          |         |        |         |       |         |        |       |       |        |       |       |       |       |
|----------------------|----------|---------|--------|---------|-------|---------|--------|-------|-------|--------|-------|-------|-------|-------|
| Shaft Dia. In.       | Part No. | Brg No. | A SQ.  | B       | C     | D       | E      | F     | G UNF | H Core | J     | K     | L     | M     |
| 1                    | HFT-16   | HT-16   | 4 7/8  | 3 57/64 | 17/32 | 1       | 1 7/16 | 15/32 | 6-32  | 2 5/16 | 2 3/4 | 9/16  | 17/32 | 5/8   |
| 1 3/16               | HFT-19   | HT-19   | 5 9/16 | 4 19/32 | 17/32 | 1 5/32  | 1 9/16 | 15/32 | 6-32  | 2 7/8  | 3 1/4 | 5/8   | 9/16  | 11/16 |
| 1 1/4R               | HFT-20R  | HT-20R  | 5 9/16 | 4 19/32 | 17/32 | 1 5/32  | 1 9/16 | 15/32 | 6-32  | 2 7/8  | 3 1/4 | 5/8   | 9/16  | 11/16 |
| 1 7/16               | HFT-23   | HT-23   | 6 1/8  | 5 1/8   | 9/16  | 1 5/16  | 1 3/4  | 17/32 | 6-32  | 3 5/16 | 3 3/4 | 11/16 | 19/32 | 3/4   |
| 1 1/2                | HFT-24   | HFT-24  | 6 3/4  | 5 21/32 | 9/16  | 1 15/32 | 2 1/64 | 17/32 | 10-24 | 3 1/2  | 4 1/8 | 3/4   | 5/8   | 53/64 |

\* End Caps sold separately



HFT-23



HFT-23 HFC CAP



HFT-23 HEC CAP

## Non-Expansion Bearing Installation Instructions

### 1 Inspect Shaft

- Clean/remove burrs.
- Check shaft diameter: See Table 1.
- Mounting surfaces must be flat.



### 2 Place Bearing On Shaft

- Apply light film of oil on shaft.
- Slide, do not hammer, bearing into shaft.



### 3 Bolt Housing To Structure

- Install housing mounting bolts.
- Align bearing and shaft (1 1/2° max.)
- Check shaft for freedom of rotation.
- Tighten bolts to recommended fastener torque.

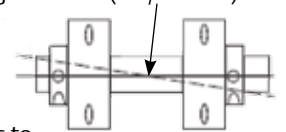

### 4a Setscrew Locking (Alignment)

- Align setscrew positions on both bearings.

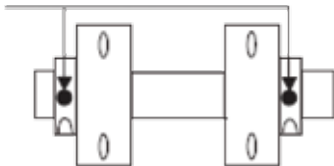

### 4b Setscrew Locking (Tighten Screws)

- Step 1: Torque setscrew "A" to 1/2 recommended torque. See Table 2.
- Step 2: Torque setscrew "B" to full recommended torque. See Table 2.
- Step 3: Torque setscrew "A" to full recommended torque. See Table 2.

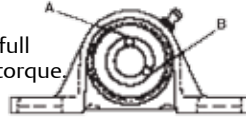

### 5 End Cap Installation

- Slide V-Ring Seal on shaft and position next to inner ring (HFC only)
- Position cap so it lines up with holes in housing.
- Place lock washers at hole locations.
- Torque cap screws to fix cap in place.

**Table 1**

| Shaft Diameter (Inches) | Tolerance (Inches) |
|-------------------------|--------------------|
| 1 - 1 15/16             | +0.0000 / -0.0005  |

**Table 2**

| Shaft Diameter (Inches) | Setscrew Diameter | Hex Size Across Flats (Inches) | Recommended (In-Lbs) |
|-------------------------|-------------------|--------------------------------|----------------------|
| 1 - 1 1/4R              | 1/4 - 28          | 1/8                            | 66 - 85              |
| 1 7/16 - 1 3/4          | 5/16 - 24         | 5/32                           | 128 - 164            |
| 1 7/8 - 1 15/16         | 3/8 - 24          | 3/16                           | 228 - 296            |

**Table 3**

| Shaft Diameter (Inches) | Keyway Width (Inches) | Keyway Depth (Inches) | Square Head Width (Inches) |
|-------------------------|-----------------------|-----------------------|----------------------------|
| 1 - 1 1/4R              | 9/32                  | 9/32                  | 1/4                        |
| 1 7/16 - 1 3/4          | 11/32                 | 11/32                 | 5/16                       |
| 1 7/8 - 1 15/16         | 13/32                 | 13/32                 | 3/8                        |



# Expansion Bearing Installation Instructions

## 1 Inspect Shaft

- Clean/remove burrs.
- Check shaft diameter: See Table 1.
- Mounting surfaces must be flat.



## 2 Square Head Setscrew Installation

- Remove both setscrews from bearing inner ring.
- Install Square Head Setscrew, supplied with HEC End Cap, into one of the setscrew holes. (square end in bore.)

## 3 Place Bearing On Shaft

- Apply light film of oil on shaft.
- Align Square Head Setscrew with keyway in shaft.
- Slide, do not hammer, bearing into shaft.



## 4 Bolt Housing To Structure

- Install housing mounting bolts.
- Align bearing and shaft ( $1\ 1/2^\circ$  max.)
- Check shaft for freedom of rotation.
- Tighten bolts to recommended fastener torque.

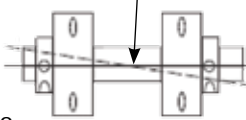

## 5 End Cap Installation

- Position cap so it lines up with holes in housing.
- Place lock washers at hole locations.
- Torque cap screws to fix cap in place.

Table 4

| 2-Bolt  | 4-Bolt | Max Recommended Speed (RPM) | Max Recommended Load (Lbs) |
|---------|--------|-----------------------------|----------------------------|
| HFT-16  | -      | 800                         | 150                        |
| HFT-19  | -      | 700                         | 250                        |
| HFT-20R | -      | 700                         | 250                        |
| HFT-23  | HF-23  | 600                         | 350                        |
| HFT-24  | HF-24  | 500                         | 450                        |
| -       | HF-27  | 500                         | 550                        |
| -       | HF-28  | 500                         | 550                        |
| -       | HF-30  | 400                         | 650                        |
| -       | HF-31  | 400                         | 650                        |

## Expansion Bearings

Most furnace applications require a fixed and float bearing design to accept the axial shaft expansion encountered at the elevated operating temperatures. A square head setscrew (supplied with the HEC cap) and a customer-machined keyway in the shaft, allows the shaft to expand through the bore of the bearing when the shaft temperature rises. (See Picture)

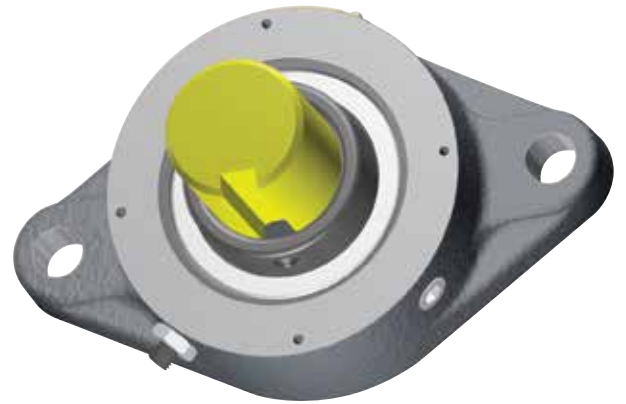

## Calculating Shaft Growth\*

### Carbon Steel

Shaft growth (in) = .0000063 x Shaft Length (in) x Change in Temperature (°F)

### Stainless Steel

Shaft growth (in) = .0000097 x Shaft Length (in) x Change in Temperature (°F)

\*Shaft Length = Shaft Length Between Bearings

\*Temperature change = The maximum temperature difference between the shaft and bearing support structure.



## Lubrication

Sealmaster HF and HFT bearings are supplied with a high quality/high temperature synthetic lubricant with temperature operating range up to 400°F. The units are equipped with plugs in the lubrication holes in the housing. Bearing life may be extended by addition of fresh lubricant to the unit. Frequent relubrication is recommended as temperatures approach 400°F.

## Other High Temperature Products

**Sealmaster also offers a variety of other High Temperature bearings, including:**

HT: Nomex\* Seal, Synthetic High Temperature Grease, Increased Internal Clearance

HI: Nomex Seal, Krytox\* 226 Grease, Increased Internal Clearance

HIY: Nomex Seal, Krytox 226 Grease, Increased Internal Clearance,  
1/2 Dog And Wire Setscrew For Expansion

HTA: Nomex Seal, Synthetic High Temperature Grease, Increased Internal Clearance,  
Air Handling Housing Fit, Noise Tested

HTC: High Temperature Contact Seals, Synthetic High Temperature Grease,  
Increased Internal Clearance

*\* NOMEX and KRYTOX are believed to be the trademarks and/or trade names of E.I. du Pont de Nemours and Company and are not owned or controlled by Regal Beloit America, Inc.*

| Environment | Temperature (F°) | Speed % Catalog Max (1) | Frequency (2)      |
|-------------|------------------|-------------------------|--------------------|
| Dirty       | -20 to 400       | 0 - 100%                | Daily to 1 Week    |
| Clean       | 200 to 300       | 0 - 25%                 | 1 to 3 Month       |
|             |                  | 26 - 50 %               | 2 to 6 Weeks       |
|             |                  | 51 - 75%                | Daily to 1 Week    |
|             |                  | 76 - 100%               | Daily to 1 Week    |
|             | 300 to 400       | 0 - 25%                 | 2 Weeks to 1 Month |
|             |                  | 26 - 50 %               | 1 to 2 Weeks       |
|             |                  | 51 - 75%                | Daily to 1 Week    |
|             |                  | 76 - 100%               | Daily to 1 Week    |

(1) Maximum speed per Table 4, page 9

(2) Use high quality lithium complex grease, NGLI#2 and synthetic hydrocarbon oil with ISO 220 viscosity.





Regal Power Transmission Solutions  
7120 New Buffington Road  
Florence, KY 41042  
Customer Service: 800-626-2120  
Fax: 800-262-3292  
Technical Service: 800-626-2093

[www.RegalPTS.com](http://www.RegalPTS.com)

#### APPLICATION CONSIDERATIONS

The proper selection and application of power transmission products and components, including the related area of product safety, is the responsibility of the customer. Operating and performance requirements and potential associated issues will vary appreciably depending upon the use and application of such products and components. The scope of the technical and application information included in this publication is necessarily limited. Unusual operating environments and conditions, lubrication requirements, loading supports, and other factors can materially affect the application and operating results of the products and components and the customer should carefully review its requirements. Any technical advice or review furnished by Regal Beloit America, Inc. and its affiliates with respect to the use of products and components is given in good faith and without charge, and Regal assumes no obligation or liability for the advice given, or results obtained, all such advice and review being given and accepted at customer's risk.

For a copy of our Standard Terms and Conditions of Sale, Disclaimers of Warranty, Limitation of Liability and Remedy, please contact Customer Service at 1-800-626-2120. These terms and conditions of sale, disclaimers and limitations of liability apply to any person who may buy, acquire or use a Regal Beloit America Inc. product referred to herein, including any person who buys from a licensed distributor of these branded products.

Sealmaster is a trademark of Regal Beloit Corporation or one of its affiliated companies.  
©2015 Regal Beloit Corporation. All Rights Reserved. MCB15054E • Form9202E • Printed in USA

A Regal Brand



[www.regalbeloit.com](http://www.regalbeloit.com)