



MEGAFLEX



MEGADYNE

Introduction to truly endless belts	2	AT5 - AT5 DL	19
Product range	3	AT10 - AT10 DL	20
Classifications	4	AT15	21
Technical calculation	6	AT20 - AT20 DL	22
Calculation example	7	MTD8	23
Belt selection tables	8	RPP5 - RPP5 DL	24
Safety factor	9	RPP8 - RPP8 DL	25
Belt installation	10	RPP14 - RPP14 DL	26
Position and transmission precision	11	ATG10	27
Belt data		P2	28
XL - XL DL	12	Measuring lengths	29
L - L DL	13	Cleats	30
H - H DL	14	Antistatic polyurethane timing belts	39
XH - XH DL	15	Cover properties	40
T5 - T5 DL	16	Megaflex feasibility table	42
T10 - T10 DL	17	Special execution feasibility	43
T20 - T20 DL	18	Special execution photos	44

INTRODUCTION TO TRULY ENDLESS BELT

MEGADYNE commenced manufacturing transmission belts in 1957 and extruding polyurethane endless belts in 1990. Megaflex belts are manufactured in thermoplastic polyurethane, that gives superior wear and abrasion resistance. Various grade of steel cords offer good running characteristics even with high tractive load. Great production flexibility grant to designers possibility to match any technical requirement and solution. By selecting different components and material, Megaflex belts can be manufactured to meet every customer requirement.

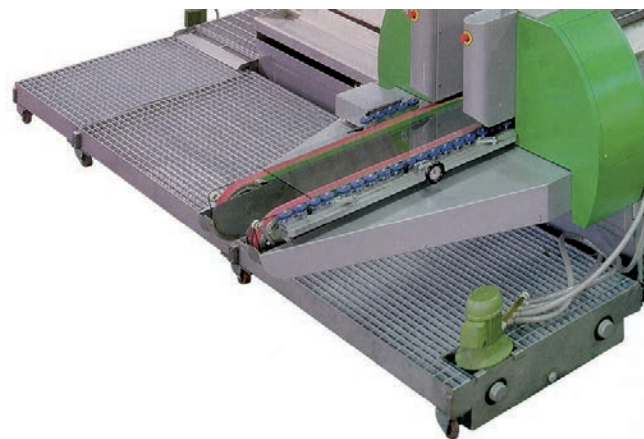
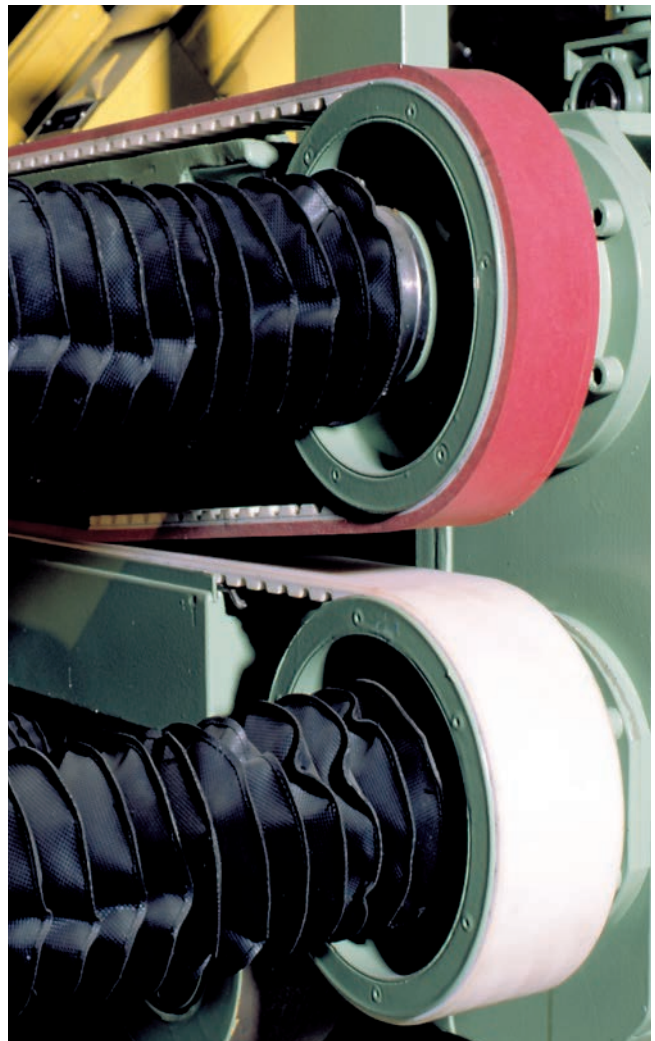
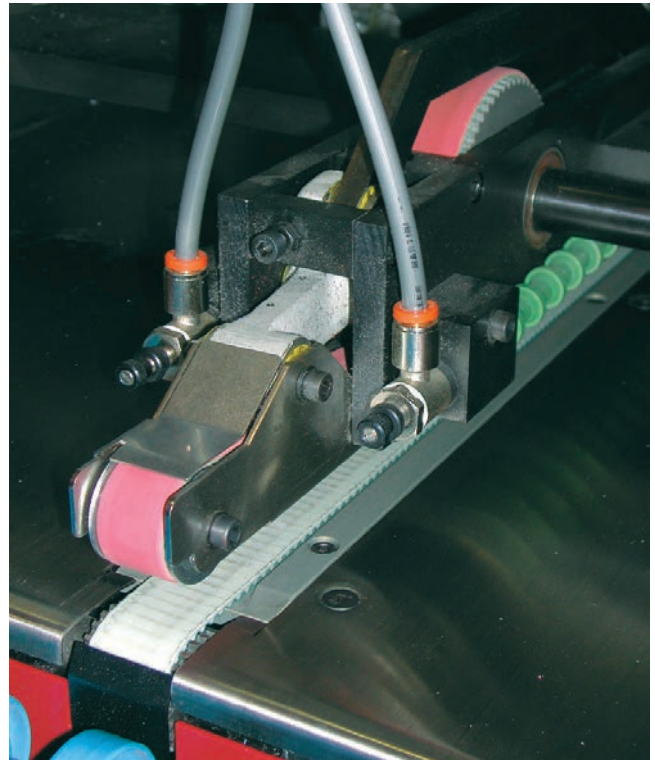
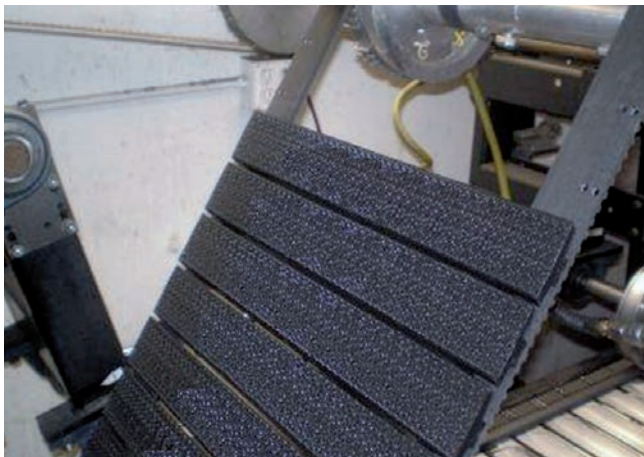

PRODUCT RANGE

Thanks to their features, Megaflex belts can be successfully used in a wide range of application such as:

- High Power Transmissions
- Ceramic industry
- Marble & Stone industry
- Glass Industry
- Painting Mixer machines
- Heavy Transport systems
- Wood industry
- Food industry

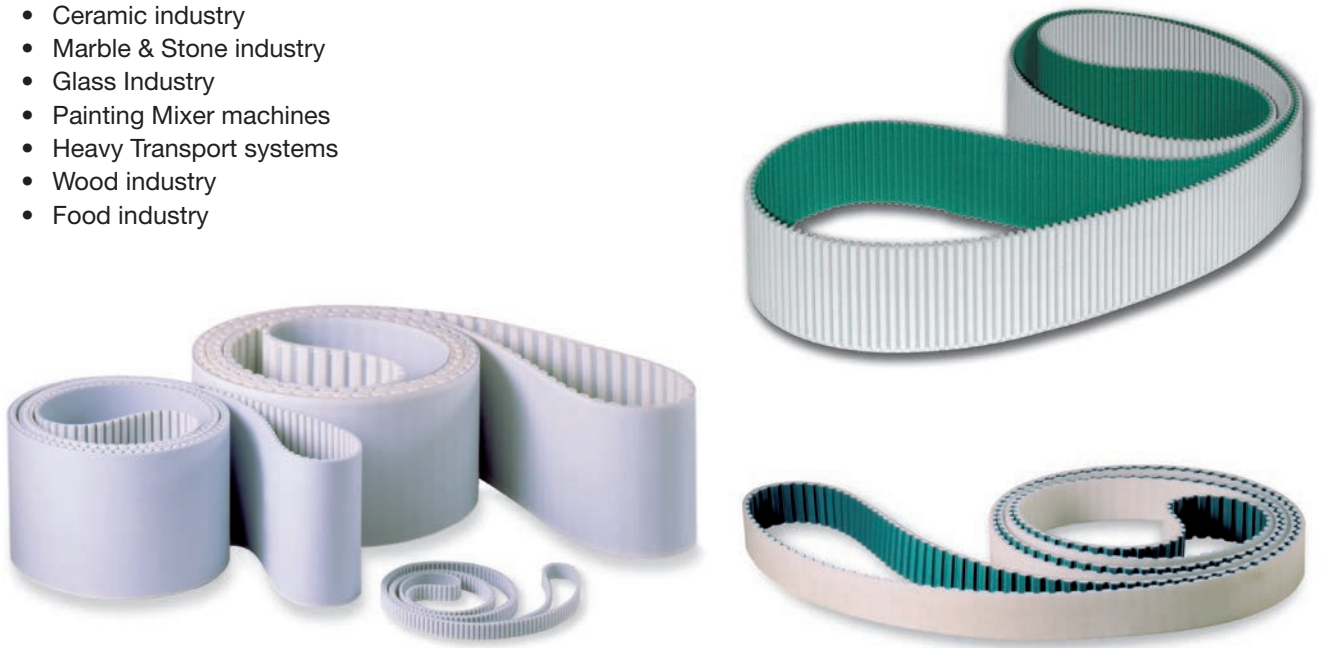

Megadyne has developed a very wide range of solutions with numerous tooth designs, tensile members and compound, suitable for all the applications.

STANDARD RANGE

STANDARD

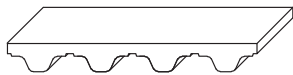

XL - L - H - XH



T5 - T10 - T20

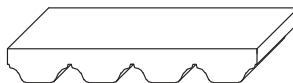

AT5 - AT10 - AT20

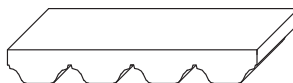

AT15

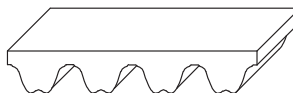

RPP5 - RPP8 - RPP14

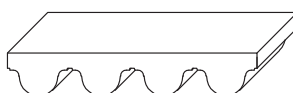

MTD8



ATG10

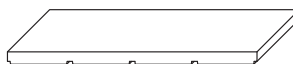

P2

DOUBLE SIDED

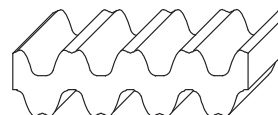
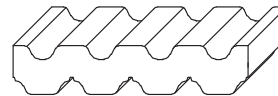

CLASSIFICATIONS

CLASSIFICATIONS

Megaflex Timing Belts are manufactured in thermoplastic polyurethane, with single helicoidal steel cords. This type of belts, developed by our Research & Development, offers good running characteristics and high traction loads. They are especially suited for power transmissions and conveying with high loads and speeds. The addition of a nylon coating on the teeth during production enhances the running properties for specific applications and reduces the noise due to a lower frictional coefficient. On the back of the belt an extra thickness of special coating is also possible, offering extra protection against aggressive or heavy products.

1) The body of the belts is white thermoplastic polyurethane 92 ShA, characterized by high levels of wear resistance even in the presence of shock and surge loading.

2) High strength helicoidal zinked steel tension members allow high breaking load and extremely low elongation.

The combination of these high grade materials improves belt performances which can be summarised as follows:

- exceptional resistance to abrasion and tooth shear
- low coefficient of friction
- high flexibility
- ozone and temperature resistance (-25 °C / +80 °C)
- oil, grease and gasoline resistance.

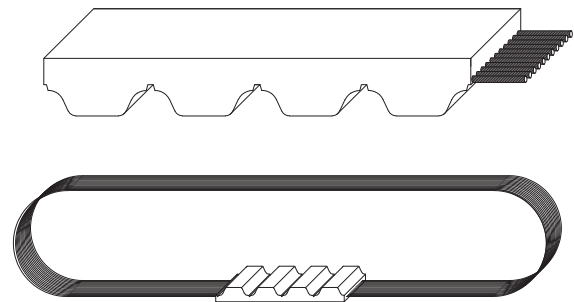

MECHANICAL AND CHEMICAL CHARACTERISTICS

- Constant dimensions
- Noiseless
- Free maintenance
- High flexibility
- High resistance steel traction cords, with little stretching and top flexibility
- Linear speeds up to 20 m/s
- Low pretension
- Constant length
- High abrasion resistance
- Ageing, Hydrolysis, Ozone resistant
- Working temperature -25 °C / +80 °C
- High resistance to Oils, Greases and Gasoline
- Fairly Acid-proof and Alkali-proof

BODY

Megaflex belts are manufactured with white thermoplastic Polyurethane 92 ShA as standard.

Special compounds (different hardnesses, special properties) are available on request. Special compound and cords have to be tested and homologated on the application. Megadyne is not responsible for wrong functioning of special product. Here under some PU characteristics:

Water

No problem in normal or sea clean water, at room temperature.

Over 60 °C there is a fast decrement of breaking strength.

Acids

In acid diluted proportions, at room temperature, this PU is moderately attacked.

In high concentration acid solutions, this PU has a very short lifespan.

Over 50 °C, acids are always dangerous for Thermoplastic PU.

Alkalis

In alkalis diluted proportions, at room temperature, this PU is moderately attacked.

In high concentration alkaline solutions, this PU has a very short lifespan.

Over 50 °C, alkalis are always dangerous for Thermoplastic PU.

Solvents

Thermoplastic PU is insoluble in the greater part of solvents. Only the very polar solvents (like tetrahydrofuran, dimethylformamide, n-methylpyrrolidone) can dissolve or tight damage PU.

The Esters or the Ketons (same as ethyl acetate or methylethylketene) can usually produce a bulge, decreasing mechanical characteristics. Aromatic Hydrocarbons and aliphatic Hydrocarbons produce very high bulge.

All the effects increase by increasing temperature.

Oils

PU has a high resistance to mineral pure oils (lubricants, engine oils, combustible oils).

Usually, high performance syntetic oils, due to special additives contained, can be incompatible with Thermoplastic PU, especially at high temperature.

Greases	PU has a high resistance to mineral pure greases (lubricating greases). Usually, high performance syntetic greases, due to special additives contained, can be incompatible with Thermoplastic PU, especially at high temperature.
Fuels	Good resistance to petrols without Alcohols. In presence of Alcohols, Thermoplastic PU can suffer deterioration. Fuels including Aromatic stuffs can produce reversible bulges.
Microorganisms	In presence of grime, containing humidity, microorganisms can develop. In case that microbial attack can produce danger, you have to use a special kind of PU.
Weather agents	Good resistance to atmospheric agents. White colour can change into light yellow under long UV exposure. In any case this hasn't influence on mechanical properties.

CORDS

Standard cord Megaflex is manufactured with helicoidal zinked steel cords as standard.

Kevlar Kevlar tension cords are suggested in:

- Non magnetic, for use in drives with metal detectors
- Food industry.



HP High performance cords have 25% strength capacity more than standard cords.

They are recommended for high repeatability applications.

HF High flexibility cords can accept smaller pulley and idler diameters than standard cords.

They are suitable for multi-shaft drives with severe reverse bending.

HPF High Performance and Flexibility cords have 25% strength capacity more like the HP cords, but they are more flexible than the HP cords. They are suggested for high performance and multi-shaft drives.

Stainless steel Stainless steel cords have 25% strength capacity less than standard cords.

They are recommended for water applications.

COATING

Megaflex can be manufactured with special coating on the teeth or on the back. Please check on pages 40 and 41. Other covers on request.

IDENTIFICATION CODE

Using the information in the table below, it is possible to identify the correct belt for every application. The code is composed of letters and numbers as the following example:

1	2	3	4	5	6					
MFX	+	50	+	AT	+	10	+	10000	+	SPECIAL MANUFACTURES

- 1) **MFX** Megaflex.
- 2) **50** This number indicates the requested belt width. The value is in mm for a belt with pitch in mm, and in inches for a belt with pitch in inches.
- 3) **AT** This code composed by letters indicates the profile.
- 4) **10** This number indicates the standard pitch of the belt. It is expressed in mm.
- 5) **10000** The last number indicates the length of the belt always in mm regardless of pitch.
- 6) **SPECIAL MANUFACTURES:**
 - special cords as Kevlar or HP or HF or HPF or stainless steel;
 - special compound as different hardness (85 ShA) or different colours (black - red - yellow - blue);
 - extra coating (NFT or AVAFC or Tenax or Linatex or Honey comb or PU black cellulose or PU yellow or Neoprene rubber). Please see page 40 and 41.

TECHNICAL CALCULATION

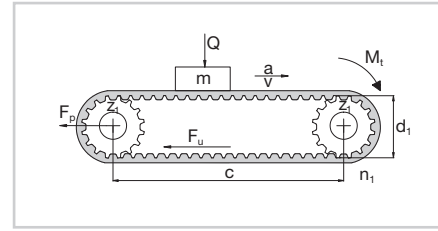
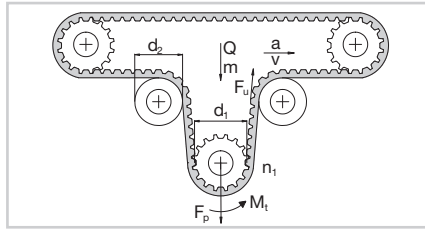
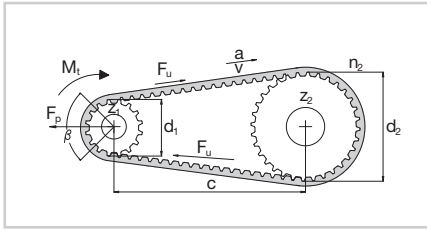

Symbol	Unit	Definition	Symbol	Unit	Definition
b	mm	belt width	F_p	N	pretension
L	mm	belt length	F_u	N	peripheral force
c	mm	centre distance	F_{p spec}	N/cm	transmittable force per tooth per unit
d_i	mm	pitch diameter of pulley i	M_t	Nm	drive torque
m	kg	total conveyed mass	n_i	1/min	revs/min (RPM) on pulley i
a	m/s ²	acceleration	P	kW	drive power
v	m/s	belt speed	Q	N	force exerted by mass (m)
C_s	-	safety factor	z_i		number of teeth on pulley i
g	m/s ²	gravity (9.81)	z_m		number of teeth in mesh on drive pulley
μ	-	coefficient of friction between belt and guide	z_s		number of teeth on small pulley
p	-	belt pitch	z_L		number of teeth on largest pulley
MTL	N	Max Traction Load	BS	N	Breaking Strength

Max Traction Load is maximum acceptable traction on cords

Breaking Strength is necessary load to break belt cords

CHOICE OF BELT PITCH, LENGTH AND PULLEY

For optimal belt pitch see tables on page 8.

For optimal choice of pulley size, it is desirable to have as nearest to 12 teeth in mesh as possible.

Belt length will be approximately $L = 2c + 1,57 (d_1 + d_2) + \frac{(d_2 - d_1)^2}{4c}$

Please always check available lengths in belt data pages, considering you must have an integer number of teeth. The actual center distance will be:

$$c = \frac{1}{4} \left[L - \frac{p}{2} (z_1 + z_2) + \sqrt{\left[L - \frac{p}{2} (z_1 + z_2) \right]^2 - 2 \left[\frac{p}{\pi} (z_2 - z_1) \right]^2} \right]$$

CALCULATION OF THE PERIPHERAL FORCE ON THE TIMING BELT

Knowing mass \longrightarrow For horizontal & conveying drives $F_u = (m \cdot a) + (m \cdot g \cdot \mu)$

(Note: values of μ can be found in table 3 on page 9).

\longrightarrow For vertical drives $F_u = (m \cdot a) + (m \cdot g)$

Knowing drive torque

$$F_u = 2000 \frac{M_t}{d_1}$$

Knowing drive power

$$F_u = 19,1 \cdot 10^6 \cdot \frac{P}{(d_1 \cdot n_1)}$$

DETERMINATION OF THE BELT WIDTH

The belt width b should be calculated using the following formula:

$$b = \frac{(F_u \cdot C_s \cdot 10)}{(F_{p spec} \cdot z_m)}$$

C_s = safety factor from page 9 table number 4

F_u = from above calculation

z_m = number of teeth in mesh on driver pulley (the nearest lower integer number)

$$z_m = \left[0,5 - \left(\frac{4 \cdot p}{79 \cdot c} \right) \cdot (z_L + z_s) \right] \cdot z_s \text{ (if calculated } z_m > 12, \text{ use } z_m = 12)$$

$F_{p spec}$ = transmittable force per tooth per unit width (see table on belt data pages)

PRE-TENSIONING

The suggested installation tension, see page 10.

CORD CHECK (Especially for power transmission, check carefully according procedure)

The maximum allowable tensile load of the belt pitch/width combination selected (see tables on belt data pages):

$$\text{Max traction load of chosen belt} > \frac{F_p}{2} + (F_u \cdot C_s)$$

SPROCKET AND IDLER DIAMETER CHECK

Ensure that all selected pulley and idler diameters are equal to or greater than the minimum value specified in corresponding belt data page.

MACHINE DATA

$P = 2\text{ kW}$
 Revolution = 1500 1/min
 Center distance = 900 mm
 Speed ratio (request) = 1:2
 Max radial space = 55 mm in the driven pulley
 Rotary presses
 Engine type B

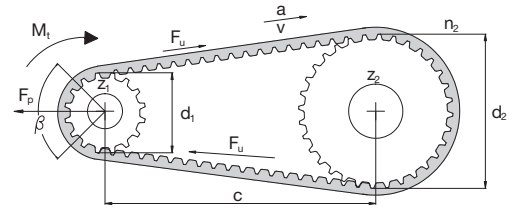

CHOICE OF BELT PITCH, LENGTH AND PULLEY

According belt pitch selection table n.1 on page 8, considering the value of P and RPM, we select RPP5.
 Then we consider the nearest pulley diameter to the requested value and the corresponding n. of the teeth (see technical information on page 24). Therefore $z_1 = 30$ teeth ($d_1 = 47,75$ mm) and $z_2 = z_1 \cdot 2 = 60$ ($d_2 = 95,49$ mm).
 Belt length is $L = 2c + 1,57(d_1 + d_2) + [(d_2 - d_1)^2 / 4c] = 2 \cdot 900 + 1,57 \cdot (47,75 + 95,49) + (95,49 - 47,75)^2 / (4 \cdot 900) = 2025,5$ mm.

Because of this, the actual center distance will be:

$$\begin{aligned}
 c &= \left[\frac{1}{4} \left[L - \frac{p}{2} (z_1 + z_2) + \sqrt{\left[L - \frac{p}{2} (z_1 + z_2) \right]^2 - 2 \left[\frac{p}{\pi} (z_2 - z_1) \right]^2} \right] \right] = \\
 &= \left[\frac{1}{4} \left[2025 - \frac{5}{2} (30 + 60) + \sqrt{\left[2025 - \frac{5}{2} (30 + 60) \right]^2 - 2 \left[\frac{5}{\pi} (60 - 30) \right]^2} \right] \right] = 899,68 \text{ mm}
 \end{aligned}$$

CALCULATION OF THE PERIPHERAL FORCE ON THE TIMING BELT

Knowing the drive power $F_u = 19,1 \cdot 10^6 \cdot \frac{P}{(d_1 \cdot n_1)} = 19,1 \cdot 10^6 \cdot \frac{2}{(47,75 \cdot 1500)} = 534\text{ N}$

DETERMINATION OF BELT WIDTH

$$b = \frac{(F_u \cdot C_s \cdot 10)}{(F_{p \text{ spec}} \cdot z_m)} = \frac{(534 \cdot 1,5 \cdot 10)}{(24 \cdot 12)} = 27,8 \text{ mm}$$

F_u from before (534N)
 C_s from page 9 Table n.4, $C_s = 1,5$
 $z_m = 14,6 > 12$ so $z_m = 12$
 $F_{p \text{ spec}} = 24\text{ N/cm}$ (refer page 24 at 1500 RPM)

Since the next closest width is 30mm: 30RPP5 is chosen.

PRE-TENSIONING

$F_p = F_u$ so $F_p = 534\text{ N}$

CORD CHECK (Especially for power transmission, check carefully according procedure)

From page 24 max traction load is 2100N

$$\text{MTL} > \frac{F_p}{2} + (F_u \cdot C_s) \quad \frac{F_p}{2} + (F_u \cdot C_s) = \frac{709}{2} + (534 \cdot 1,5) = 1155\text{ N}$$

2100N > 1155N selected belt is acceptable.

SPROCKET AND IDLER DIAMETER CHECK

Checking data on page 24 for pulleys and idlers, it can be seen that the drive has acceptable pulley diameter.

Selected belt is **30 RPP5 2025**.

BELT SELECTION TABLES

BELT PITCH SELECTION

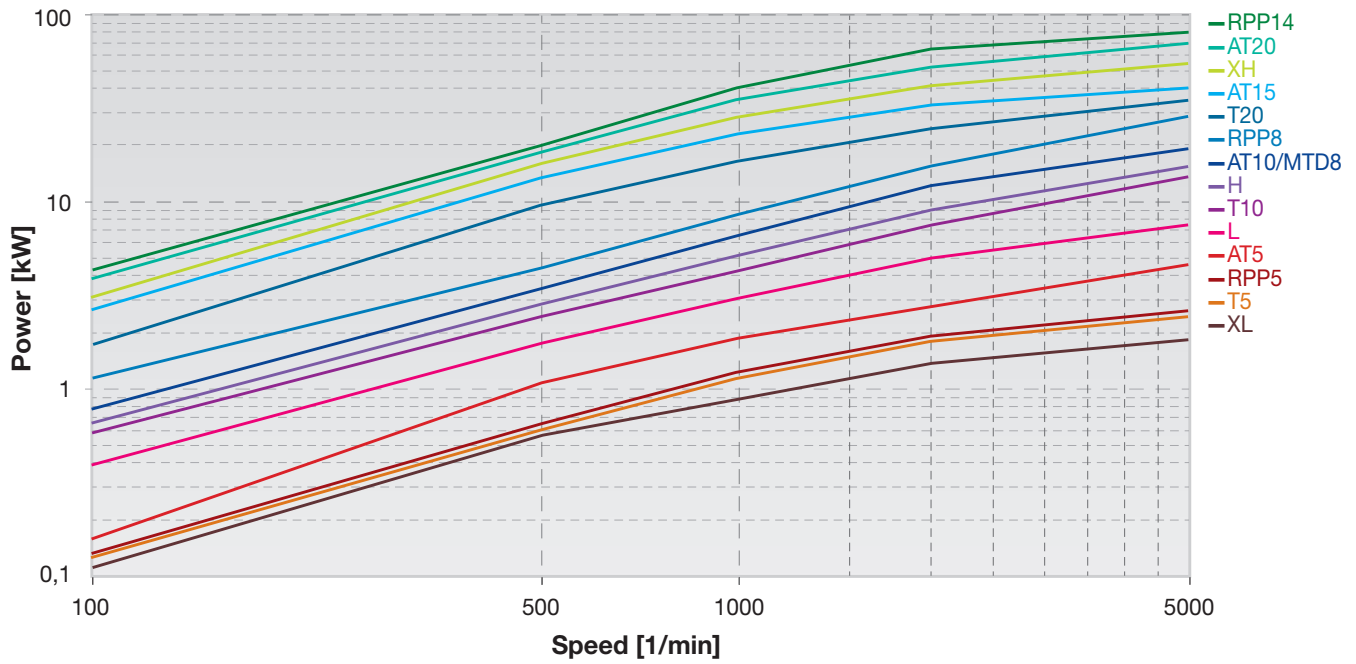

Table 1

BELT WIDTH SELECTION

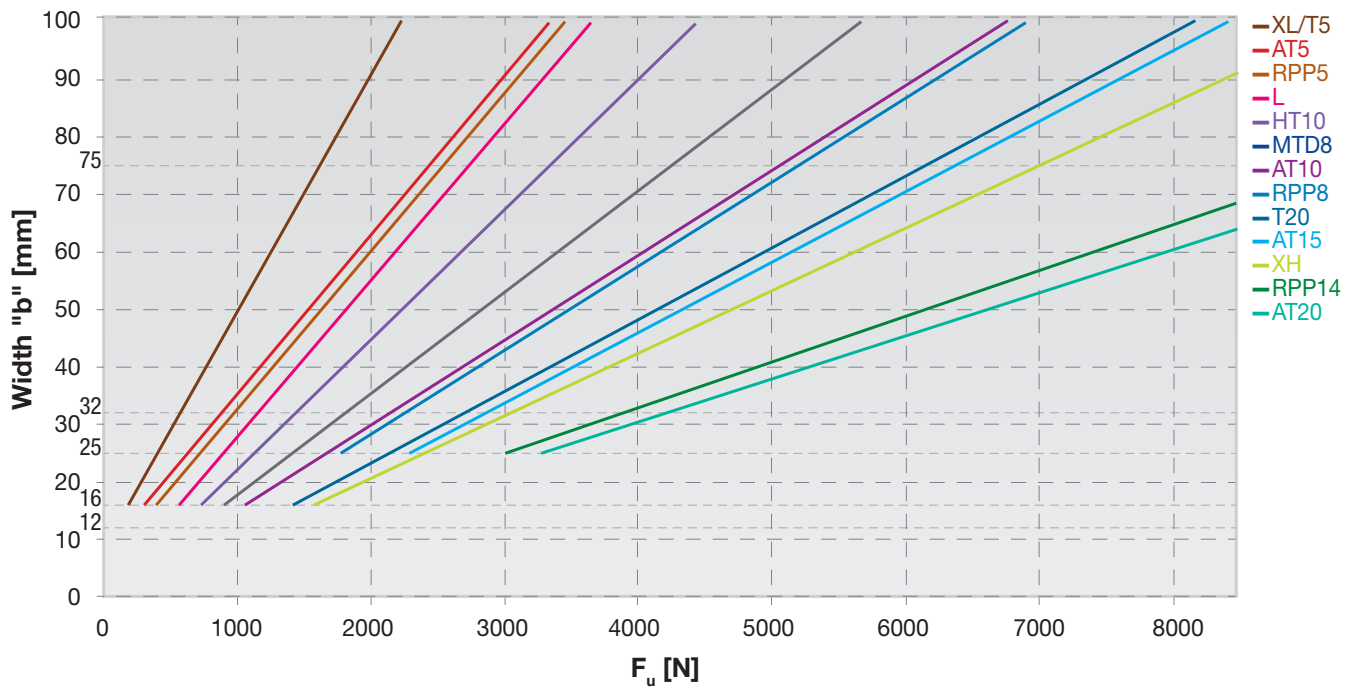

Table 2

TABLE 3 - FRICTION COEFFICIENT BETWEEN BELT AND GUIDE

Polyurethane / smooth steel	$\mu = 0,5$	Polyurethane NFT / nylon	$\mu = 0,15$
Polyurethane / rough steel	$\mu = 0,7$	Polyurethane / aluminium	$\mu = 0,8$
Polyurethane / abrasive steel	$\mu = 0,9$	Polyurethane NFT / aluminium	$\mu = 0,45$
Polyurethane NFT / smooth steel	$\mu = 0,25$	Volvent friction on dry surface	
Polyurethane NFT / rough steel	$\mu = 0,35$	Bearing	$\mu = 0,015$
Polyurethane NFT / abrasive steel	$\mu = 0,6$	Roller / polyurethane belt	$\mu = 0,03 / 0,06$
Polyurethane / nylon	$\mu = 0,35$	Bush	$\mu = 0,15$

TABLE 4 - SAFETY FACTOR

The choice of the SAFETY FACTOR C_s , depends on the operating condition. The following table shows the value to be used:

Driven Machine	Driver			Driven Machine	Driver		
	Type A	Type B	Type C		Type A	Type B	Type C
Office machinery				Sawmill machinery	1,4	1,6	1,8
Typewriters	1	1,1	1,2	Brick machinery			
Computers, printers	1,1	1,2	1,3	Mixers	1,4	1,6	1,8
Teleprinters, photocopiers	1,1	1,2	1,3	Pug mills	1,6	1,8	2
Motion-picture projectors and cameras	1	1,2	1,2	Textile machinery			
Domestic machinery				Spoolers and warping machines	1,2	1,4	1,6
Centrifuges	1	1,1	1,2	Spinning and twisting machines	1,3	1,5	1,7
Kitchen appliances, universal slicers	1,1	1,2	1,3	Paper machinery			
Sewing machines				Agitators, calenders, driers	1,2	1,4	1,6
Domestic sewing machines	1,1	1,2	1,3	Pumps, beaters, pulpers	1,4	1,6	1,8
Industrial sewing machines	1,2	1,3	1,4	Printing machinery			
Laundry machinery				Linotype machines, cutters, folders	1,2	1,4	1,6
Driers	1,2	1,4	1,6	Rotary presses	1,3	1,5	1,7
Washing machines	1,4	1,6	1,8	Screens			
Bakery machinery and dough mixers	1,2	1,4	1,6	Drum screens	1,2	1,4	1,6
Conveyors				Vibrating screens	1,3	1,5	1,7
Light-duty belt conveyors	1,1	1,2	1,3	Fans, Blowers			
Belt conveyor for ore, coal, sand	1,2	1,4	1,6	Exhauster, radial blowers	1,4	1,6	1,8
Heavy duty conveyors	1,4	1,6	1,8	Mine ventilators, axial blowers	1,6	1,8	2
Elevators, screw conveyors	1,4	1,6	1,8	Compressors			
Bucket elevators	1,4	1,6	1,8	Helical compressors	1,4	1,5	1,6
Agitators				Piston compressors	1,6	1,8	2
Mixers for liquids	1,2	1,4	1,6	Pumps			
Mixers for semi-liquids	1,3	1,5	1,7	Centrifugal and gear pumps	1,2	1,4	1,6
Machine tools				Reciprocating pumps	1,7	1,9	2,1
Lathes	1,2	1,4	1,6	Generators and exciters	1,4	1,6	1,8
Drills and grinders	1,3	1,5	1,7	Elevators and hoists	1,4	1,6	1,8
Millers and planers	1,3	1,5	1,7	Centrifuges	1,5	1,7	1,9
Woodworking machinery				Rubber machinery	1,5	1,7	1,9
Lathes and band saws	1,2	1,3	1,5	Mills			
Planers and disk saws	1,2	1,4	1,6	Hammer mills	1,5	1,7	1,9
				Ball, roller and gravel mills	1,7	1,9	2,1

Type A: electric motors with low starting torque (up to 1,5 times the rated torque).

Type B: electric motors with normal starting torque (1,5 to 2,5 times the rated torque).

Type C: electric motors with high starting and breaking torque (over 2,5 times the related torque).

BELT INSTALLATION

A major difficulty installing transmission belt is to achieve correct belt tension. Lifetime of support bearings and transmission belts and therefore reliability of the complete system largely depend on an optimally adjusted belt tension. Pretension is the force needed to put tension into the system to avoid the belt jumping the pulleys as in the example below:

Not correct belt installation

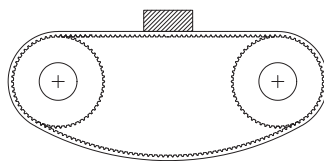

For a correct system installation, all applications with Megaflex belt can be summarized according the following cases:

1) Power transmission

2) Conveyor transmission

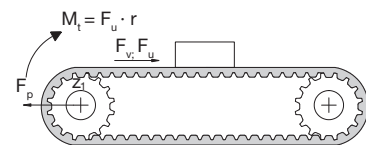
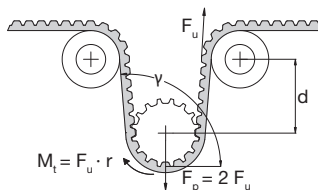
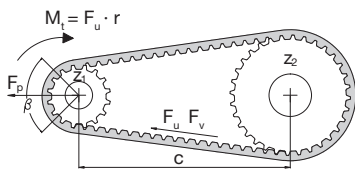

In power transmission application, the pretension force is the load which has to be applied to the center of one of the driving system's pulleys in static conditions to avoid the derailing of the belt:

For:	$z < 60$	$F_v = \frac{1}{3} \cdot F_u$	$z =$ belt teeth number
	$60 < z < 150$	$F_v = \frac{1}{2} \cdot F_u$	$F_p =$ pretension
	$z > 150$	$F_v = \frac{2}{3} \cdot F_u$	$F_u =$ peripheral force
			$F_v =$ pretension on belt span
			$\beta = \pi - 2 \arcsin \left[\frac{p(z_L - z_S)}{2 \cdot c} \right]$

For omega and conveyor transmission: $F_p = F_u$

In omega application to grant good mesh between pulley and teeth and to respect belt flexibility avoiding excessive stress on the cord, we suggest $d = 4 \cdot$ belt width and angle $\gamma = 120^\circ$.

PROCEDURE TO MEASURE

The procedure to measure the tension of the belt is to use a Belt Tensioning Gauging Equipment. This device consists of a small sensing head which is held across the belt to be measured. The belt is then tapped to induce the belt to vibrate at its natural frequency. The vibrations are detected by the sensing head and the frequency of vibration is the displayed on the measuring unit. The relation between belt static tension (T_s) and frequency of vibration (f) may be calculated using the following formula:



$$f = \frac{1}{2t} \cdot \sqrt{\frac{T_s}{m}} \quad \text{or} \quad T_s = 4 \cdot m \cdot t^2 \cdot f^2$$

Where:	
$T_s =$ Static tension (N)	$f =$ Frequency of vibration in Hertz (Hz)
$m =$ Belt mass per unit length (kg/m)	$t =$ Free belt span length in meters (m)

For a correct system functioning and to increase belt life, it is necessary a correct pulley installation: pulleys have to be parallel and aligned as shown in drawing 1 (correct configuration). If pulleys are not parallel as in drawing 2, belt could fall during functioning and this can damages to complete equipment.

To grant a correct belt running α and Δx must be as smaller as possible. For more information, please contact our technical staff.

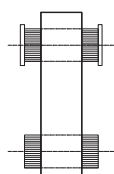

Drawing 1

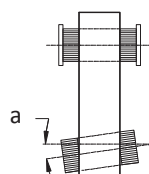

Drawing 2

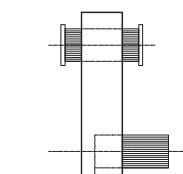

Drawing 3

POSITIONING AND TRANSMISSION PRECISION

Backlash between belt and pulley teeth is very important for positioning precision and transmission synchronism

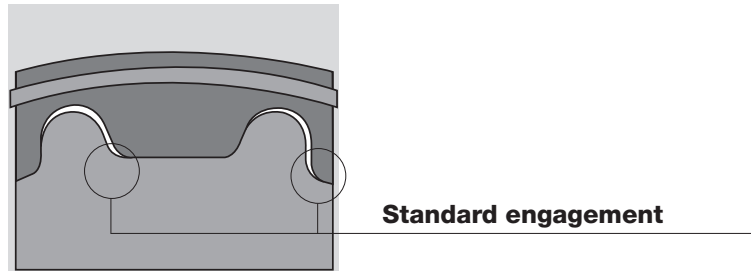

To improve transmission precision, it is possible to use zero or reduced backlash pulleys. Please note that these pulleys don't reduce the elasticity of belt teeth or cords.

Maximum recommended pulley teeth is:

Till 100 1/min $z = 40$

Till 500 1/min $z = 30$

Till 1000 1/min $z = 20$

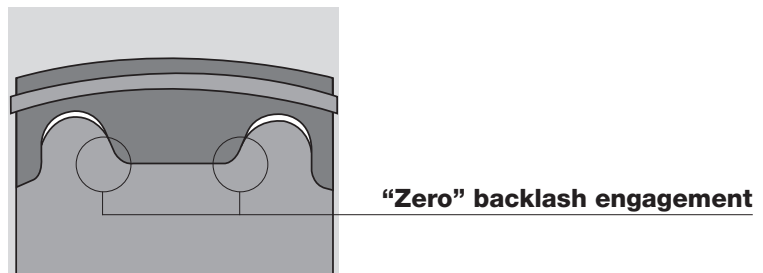

In following table, there is a list of average values for backlashes:

Available pitch for 'zero' backlash pulleys	T5 XL	T10 L H	T20 XH	AT5	AT10	AT20
Average backlash value for standard	0,6	1,2	2,4	0,2	0,4	0,8

RPP belts and pulleys offer great solution for positioning systems because their parabolic profile reduces backlash and improves meshing quality.

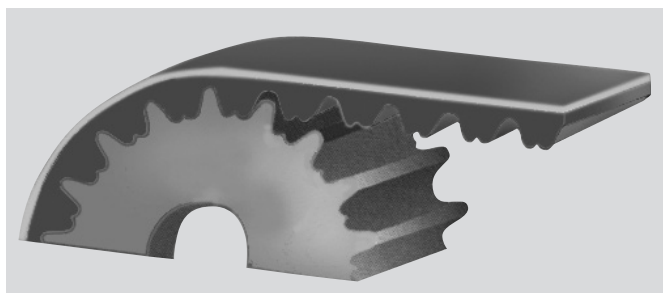

MEGAFLEX XL - XL DL

BELT CHARACTERISTICS

STANDARD WIDTHS (inch)	050	075	100	150	200	300	400	600
STANDARD WIDTHS (mm)	12,7	19,05	25,4	38,1	50,8	76,2	101,6	152,4
Weight for standard belt (gr/m)	28	42	56	85	112	170	224	340
Weight for DL belt (gr/m)	32	47	63	95	127	190	253	380

Standard compound: **white polyurethane thermoplastic 92ShA**

Standard back cover: **none**

Standard tooth cover: **none**

Standard cord: **zinc plated steel**

Standard width tolerance: **+/-0,5 mm**

Standard thickness tolerance: **+/-0,3 mm**

Standard length: **from 1503,68 mm (1905 mm with NFT) till 22768,56 mm**

Standard length tolerance: See page 29

Special version belt on request: See page 42

Tooth profile according ISO 5296-1

DL belt available only with standard steel, HF and stainless cord.

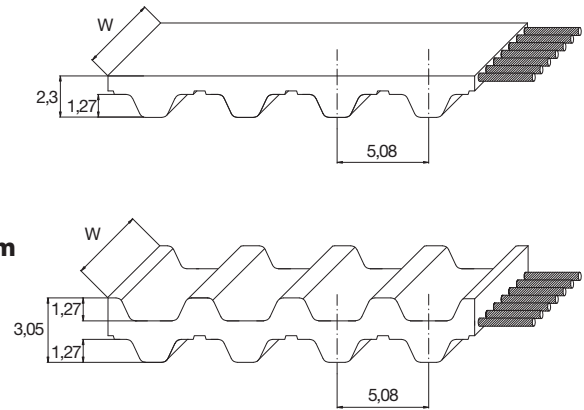

TOOTH RESISTANCE

RPM (1/min)	0	20	40	60	80	100	200	300	400	500	750	1000	1500	2000	3000	4000	5000	8000
F _{p spec} (N/cm)	19	19	18	18	17	17	16	15	15	14	13	13	12	11	10	9	8	7

TRACTION RESISTANCE

Belt width (inch)	050		075		100		150		200		300		400		600	
	M.T.L.	B.S.	M.T.L.	B.S.	M.T.L.	B.S.	M.T.L.	B.S.	M.T.L.	B.S.	M.T.L.	B.S.	M.T.L.	B.S.	M.T.L.	B.S.
Steel	385	1540	620	2490	830	3325	1275	5105	1720	6885	2750	10450	4000	14010	6035	21135
Kevlar	545	2195	885	3550	1180	4730	1815	7270	2450	9805	3915	14880	5700	19950	8595	30095
HF	505	2025	815	3270	1090	4360	1670	6695	2255	9035	3605	13710	5250	18380	7920	27730
Stainless	275	1110	445	1795	595	2390	915	3675	1235	4955	1980	7520	2880	10085	4345	15215

Average values in N (M.T.L.=Max Traction Load, B.S.=Breaking Strength)

FLEXION RESISTANCE

	Z _{min}		Z _{minDL}	
	Out. id.	Ins. id.	Outside idler (mm)	Inside idler (mm)
Steel	10	15	30	30
Kevlar	10	-	30	20
HF	10	15	30	30
Stainless	13	18	35	35

PULLEYS (for more details please see our pulley catalogue)

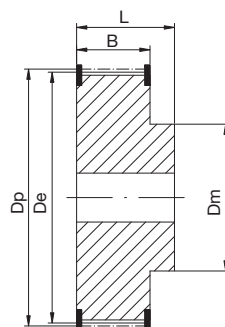

N° of teeth	Dp	De	N° of teeth	Dp	De
10	16,17	15,66	28	45,28	44,77
12	19,40	18,89	30	48,51	48,00
13	21,02	20,51	32	51,74	51,23
16	25,87	25,36	34	54,98	54,47
18	29,11	28,60	36	58,21	57,70
20	32,34	31,83	38	61,45	60,94
22	35,57	35,07	40	64,68	64,17
24	38,81	38,30	44	71,15	70,64

BELT CHARACTERISTICS

STANDARD WIDTHS (inch)	050	075	100	150	200	300	400	600
STANDARD WIDTHS (mm)	12,7	19,05	25,4	38,1	50,8	76,2	101,6	152,4
Weight for standard belt (gr/m)	53	71	95	143	190	285	380	570
Weight for DL belt (gr/m)	50	75	100	150	200	300	400	600

Standard compound: **white polyurethane thermoplastic 92ShA**

Standard back cover: **none**

Standard tooth cover: **none**

Standard cord: **zinc plated steel**

Standard width tolerance: **+/-0,5 mm**

Standard thickness tolerance: **+/-0,3 mm**

Standard length: **from 1504,95 mm (1905 mm with NFT) till 22764,75 mm**

Standard length tolerance: See page 29

Special version belt on request: See page 42

Tooth profile according ISO 5296-1

DL belt available only with standard steel, HF and stainless cord.

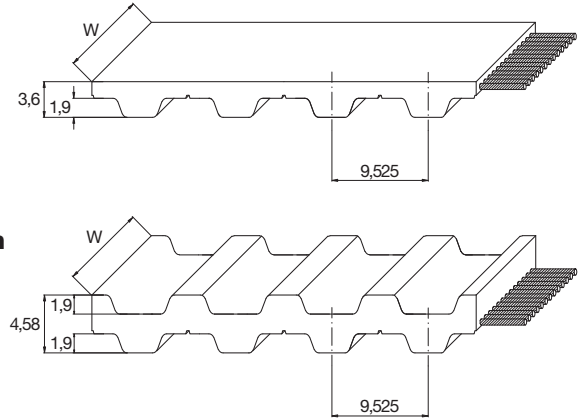

TOOTH RESISTANCE

RPM (1/min)	0	20	40	60	80	100	200	300	400	500	750	1000	1500	2000	3000	4000	5000	8000
F _{p spec} (N/cm)	37	36	35	35	34	33	31	29	28	27	24	23	20	19	16	15	13	11

TRACTION RESISTANCE

Belt width (inch)	050		075		100		150		200		300		400		600	
	M.T.L.	B.S.	M.T.L.	B.S.	M.T.L.	B.S.	M.T.L.	B.S.	M.T.L.	B.S.	M.T.L.	B.S.	M.T.L.	B.S.	M.T.L.	B.S.
Steel	825	3305	1335	5345	1780	7125	2735	10945	3690	14765	5895	22400	8580	30040	12945	45315
HF	770	3085	1245	4985	1660	6650	2550	10210	3440	13775	5500	20900	8005	28025	12075	42275
Stainless	675	2715	1095	4385	1460	5850	2245	8985	3030	12120	4840	18390	7045	24660	10625	37200

Average values in N (M.T.L.=Max Traction Load, B.S.=Breaking Strength)

FLEXION RESISTANCE

	Out. Id.		Ins. Id.	
	Z _{min}	Z _{minDL}	Outside idler (mm)	Inside idler (mm)
Steel	15	20	60	60
HF	12	18	40	40
Stainless	18	22	65	65

PULLEYS (for more details please see our pulley catalogue)

N° of teeth	Dp	De	N° of teeth	Dp	De
15	45,48	44,72	32	97,02	96,26
18	54,57	53,81	34	103,08	102,32
20	60,64	59,88	36	109,15	108,39
22	66,70	65,94	40	121,28	120,52
24	72,77	72,01	44	133,40	132,64
26	78,83	78,07	48	145,53	144,76
28	84,89	84,13	56	169,79	169,03

MEGAFLEX H - H DL

BELT CHARACTERISTICS

STANDARD WIDTHS (inch)	050	075	100	150	200	300	400	600
STANDARD WIDTHS (mm)	12,7	19,05	25,4	38,1	50,8	76,2	101,6	152,4
Weight for standard belt (gr/m)	61	91	122	182	243	365	487	730
Weight for DL belt (gr/m)	66	99	132	197	263	395	527	790

Standard compound: **white polyurethane thermoplastic 92ShA**

Standard back cover: **none**

Standard tooth cover: **none**

Standard cord: **zinc plated steel**

Standard width tolerance: **+/-0,5 mm**

Standard thickness tolerance: **+/-0,3 mm**

Standard length: **from 1511,3 mm (1905 mm with NFT) till 22758,4 mm**

Standard length tolerance: See page 29

Special version belt on request: See page 42

Tooth profile according ISO 5296-1

DL belt available only with standard steel, HF and stainless cord.

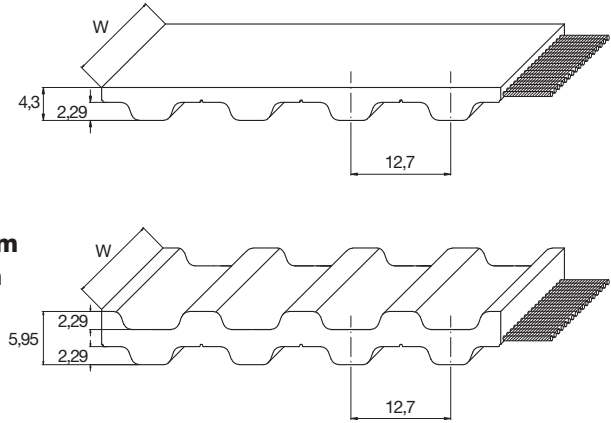

TOOTH RESISTANCE

RPM (1/min)	0	20	40	60	80	100	200	300	400	500	750	1000	1500	2000	3000	4000	5000	8000
F _{p spec} (N/cm)	44	43	42	41	40	39	36	34	33	31	29	27	24	22	19	17	16	12

TRACTION RESISTANCE

Belt width (inch)	050		075		100		150		200		300		400		600	
	M.T.L.	B.S.	M.T.L.	B.S.	M.T.L.	B.S.	M.T.L.	B.S.	M.T.L.	B.S.	M.T.L.	B.S.	M.T.L.	B.S.	M.T.L.	B.S.
Steel	995	3990	1695	6780	2290	9175	3490	13965	4785	19150	7665	29125	11170	39100	17100	59850
Kevlar	640	2565	1025	4100	1410	5640	2180	8720	3075	12310	4860	18465	6480	24620	10845	37760
HF	1045	4180	1775	7105	2400	9610	3655	14630	5015	20060	8030	30510	11700	40960	17910	62700
Stainless	805	3230	1370	5490	1855	7425	2825	11305	3875	15500	6205	23575	9040	31650	13840	48450

Average values in N (M.T.L.=Max Traction Load, B.S.=Breaking Strength)

FLEXION RESISTANCE

Belt width (inch)	Z _{min}		Outside idler (mm)	Inside idler (mm)
	Z _{min}	Z _{minDL}		
Steel	14	20	80	60
Kevlar	14	-	80	60
HF	14	18	50	50
Stainless	18	24	80	65

PULLEYS (for more details please see our pulley catalogue)

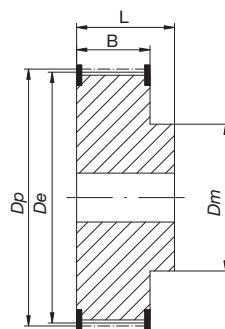

N° of teeth	Dp	De	N° of teeth	Dp	De
14	56,60	55,23	30	121,28	119,91
16	64,68	63,31	32	129,36	127,99
18	72,77	71,40	38	153,62	152,25
20	80,85	79,48	40	161,70	160,33
22	88,94	87,57	44	177,87	176,50
24	97,02	95,65	48	194,04	192,67
26	105,11	103,74	52	210,21	208,84
28	113,19	111,82	60	242,55	241,18

BELT CHARACTERISTICS

STANDARD WIDTHS (inch)	100	150	200	300	400	600
STANDARD WIDTHS (mm)	25,4	38,1	50,8	76,2	101,6	152,4
Weight for standard belt (gr/m)	267	400	533	800	1067	1600
Weight for DL belt (gr/m)	300	450	600	900	1200	1800

Standard compound: **white polyurethane thermoplastic 92ShA**

Standard back cover: **none**

Standard tooth cover: **none**

Standard cord: **zinc plated steel**

Standard width tolerance: **+/-1 mm**

Standard thickness tolerance: **+/-0,5 mm**

Standard length: **from 1511,3 mm (1911,35 mm with NFT) till 22758,4 mm**

Standard length tolerance: See page 29

Special version belt on request: See page 42

Tooth profile according ISO 5296-1

DL belt available only with standard steel, HF and stainless cord.

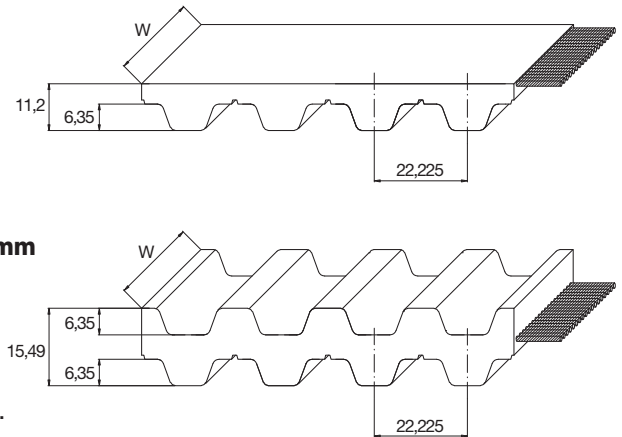

TOOTH RESISTANCE

RPM (1/min)	0	20	40	60	80	100	200	300	400	500	750	1000	1500	2000	3000	4000	5000	8000
$F_{p\ spec}$ (N/cm)	115	111	108	105	103	101	92	86	81	78	70	65	57	51	43	37	-	-

TRACTION RESISTANCE

Belt width (inch)	100		150		200		300		400		600	
	M.T.L.	B.S.	M.T.L.	B.S.	M.T.L.	B.S.	M.T.L.	B.S.	M.T.L.	B.S.	M.T.L.	B.S.
Steel	3155	12635	5185	20755	7220	28880	11400	43320	16760	58660	25525	89345
HF	3520	14095	5790	23160	8055	32220	12720	48335	18700	65455	28480	99690
Stainless	2510	10040	4120	16495	5735	22950	9060	34425	13320	46620	20285	71005

Average values in N (M.T.L.=Max Traction Load, B.S.=Breaking Strength)

FLEXION RESISTANCE

	Z_{min}		Z_{minDL}		Outside idler (mm)	Inside idler (mm)
	Steel	HF	Steel	HF		
Steel	18	25	180	150		
HF	18	22	120	120		
Stainless	24	28	180	165		

PULLEYS (for more details please see our pulley catalogue)

N° of teeth	Dp	De	Diagram Dimensions		
			L	B	D
18	127,34	124,55			
20	141,49	138,70			
22	155,64	152,83			
24	169,79	167,00			
26	183,92	181,13			
28	198,08	195,29			
30	212,23	209,44			
32	226,38	223,59			

MEGAFLEX T5 - T5 DL

BELT CHARACTERISTICS

STANDARD WIDTHS (mm)	10	16	25	32	50	75	100	150
Weight for standard belt (gr/m)	24	38	59	88	118	177	237	355
Weight for DL belt (gr/m)	27	44	68	87	137	205	274	410

Standard compound: **white polyurethane thermoplastic 92ShA**

Standard back cover: **none**

Standard tooth cover: **none**

Standard cord: **zinc plated steel**

Standard width tolerance: **+/-0,5 mm**

Standard thickness tolerance: **+/-0,15 mm**

Standard length: **from 1500 mm (1900 mm with NFT) till 22770 mm**

Standard length tolerance: See page 29

Special version belt on request: See page 42

Tooth profile according DIN 7721-1

DL belt available only with standard steel, HF and standard stainless cord.

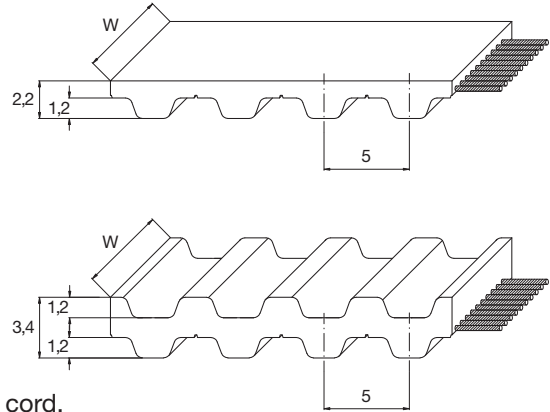

TOOTH RESISTANCE

RPM (1/min)	0	20	40	60	80	100	200	300	400	500	750	1000	1500	2000	3000	4000	5000	8000
F _{p spec} (N/cm)	24	23	23	22	22	22	20	19	19	18	17	16	15	14	12	11	11	9

TRACTION RESISTANCE

Belt width (mm)	10		16		25		32		50		75		100		150	
	M.T.L.	B.S.	M.T.L.	B.S.	M.T.L.	B.S.	M.T.L.	B.S.	M.T.L.	B.S.	M.T.L.	B.S.	M.T.L.	B.S.	M.T.L.	B.S.
Steel	265	1065	475	1900	800	3205	1035	4155	1660	6650	2685	10210	3590	13655	5900	20660
Kevlar	595	2390	1060	4255	1795	7180	2325	9310	3720	14895	6020	22875	8050	30590	13220	46280
HP	415	1665	740	2960	1250	5000	1620	6480	2590	10370	4190	15930	5605	21300	9205	32230
HF	350	1400	620	2490	1050	4205	1360	5450	2180	8720	3525	13395	4715	17915	7745	27105
HPF	530	2135	950	3800	1600	6410	2075	8310	3325	13300	5375	20425	7185	27310	11805	41325
Stainless	190	765	340	1365	575	2305	745	2990	1195	4785	1935	7353	2585	9830	4250	14875
HP stainless	470	1880	835	3340	1410	5640	1825	7315	2925	11700	4490	17970	6005	24035	9090	36365

Average values in N (M.T.L.=Max Traction Load, B.S.=Breaking Strength)

FLEXION RESISTANCE

	Z _{min}		Z _{minDL}	
	Out. Id.	Ins. Id.	Outside idler (mm)	Inside idler (mm)
Steel	10	15	30	30
Kevlar	12	-	30	30
HP	15	-	40	60
HF	10	15	30	30
HPF	12	-	40	40
Stainless	15	20	40	40
HP stainless	18	-	65	60

PULLEYS (for more details please see our pulley catalogue)

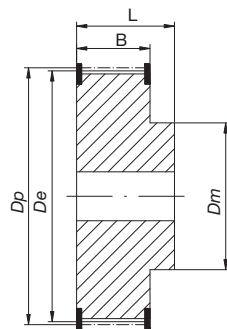

N° of teeth	Dp	De	N° of teeth	Dp	De
10	15,92	15,09	28	44,56	43,73
12	19,10	18,27	30	47,75	46,92
14	22,28	21,45	32	50,93	50,10
15	23,87	23,04	36	57,30	56,47
16	25,46	24,64	40	63,66	62,93
18	28,65	27,82	44	70,03	69,20
20	31,83	31,00	48	76,39	75,57
24	38,20	37,37	60	95,49	94,67

BELT CHARACTERISTICS

STANDARD WIDTHS (mm)	12	16	25	32	50	75	100	150
Weight for standard belt (gr/m)	60	80	125	160	250	375	500	750
Weight for DL belt (gr/m)	70	94	147	188	293	440	586	880

Standard compound: **white polyurethane thermoplastic 92ShA**

Standard back cover: **none**

Standard tooth cover: **none**

Standard cord: **zinc plated steel**

Standard width tolerance: **+/-0,5 mm**

Standard thickness tolerance: **+/-0,3 mm**

Standard length: **from 1500 mm (1900 mm with NFT) till 22770 mm**

Standard length tolerance: See page 29

Special version belt on request: See page 42

Tooth profile according DIN 7721-1

DL belt available only with standard steel, HF and standard stainless cord.

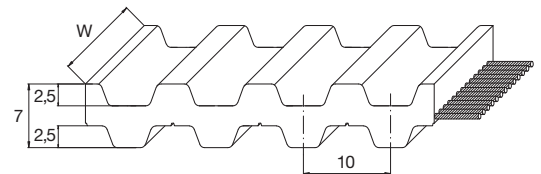
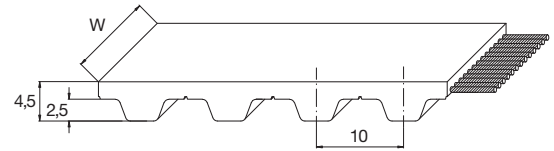

TOOTH RESISTANCE

RPM (1/min)	0	20	40	60	80	100	200	300	400	500	750	1000	1500	2000	3000	4000	5000	8000
F _{p spec} (N/cm)	51	49	48	47	46	45	41	39	37	36	33	31	28	25	22	20	18	14

TRACTION RESISTANCE

Belt width (mm)	12		16		25		32		50		75		100		150	
	M.T.L.	B.S.	M.T.L.	B.S.	M.T.L.	B.S.	M.T.L.	B.S.	M.T.L.	B.S.	M.T.L.	B.S.	M.T.L.	B.S.	M.T.L.	B.S.
Steel	995	3990	1395	5585	2290	9175	2990	11970	4785	19150	7665	29125	10290	39100	16870	59050
Kevlar	765	3075	1025	4100	1795	7180	2435	9745	3975	15900	6480	24620	8640	32830	14510	50785
HP	1350	5415	1805	7220	3155	12635	4285	17145	6990	27975	11400	43320	15200	57760	25525	89345
HF	1045	4180	1460	5850	2400	9610	3135	12540	5015	20060	8030	30510	10780	40960	17675	61860
HPF	1510	6040	2010	8055	3520	14095	4780	19130	7800	31215	12720	48335	16960	64445	28480	99690
Stainless	805	3230	1130	4520	1855	7425	2420	9690	3875	15500	6205	23575	8330	31650	13655	47800
HP stainless	1075	4300	1430	5735	2510	10040	3405	13625	5555	22230	9060	34425	12080	45900	20285	71005

Average values in N (M.T.L.=Max Traction Load, B.S.=Breaking Strength)

FLEXION RESISTANCE

	Z _{min}		Z _{minDL}		Outside idler (mm)	Inside idler (mm)
	Out. Id.	Ins. Id.	Out. Id.	Ins. Id.		
Steel	12	20	60	60		
Kevlar	15	-	60	60		
HP	15	-	100	100		
HF	12	20	50	50		
HPF	14	-	80	80		
Stainless	15	24	70	70		
HP stainless	20	-	150	150		

PULLEYS (for more details please see our pulley catalogue)

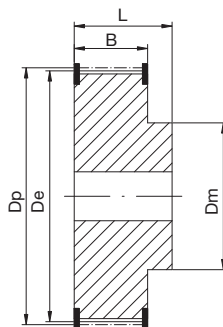

N° of teeth	Dp	De	N° of teeth	Dp	De
12	38,20	36,35	28	89,13	87,28
14	44,56	42,71	30	95,49	93,65
15	47,75	45,90	32	101,86	100,01
16	50,93	49,08	36	114,59	112,74
18	57,30	55,45	40	127,32	125,48
20	63,66	61,81	44	140,06	138,21
24	76,39	74,55	48	152,79	150,94
26	82,76	80,91	60	190,99	189,14

MEGAFLEX T20 - T20 DL

BELT CHARACTERISTICS

STANDARD WIDTHS (mm)	25	32	50	75	100	150
Weight for standard belt (gr/m)	200	256	400	600	800	1200
Weight for DL belt (gr/m)	250	320	500	750	1000	1500

Standard compound: **white polyurethane thermoplastic 92ShA**

Standard back cover: **none**

Standard tooth cover: **none**

Standard cord: **zinc plated steel**

Standard width tolerance: **+/- 1 mm**

Standard thickness tolerance: **+/-0,45 mm**

Standard length: **from 1500 mm (1900 mm with NFT) till 22760 mm**

Standard length tolerance: See page 29

Special version belt on request: See page 42

Tooth profile according DIN 7721-1

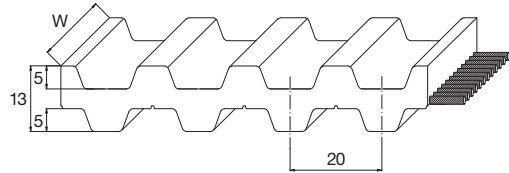
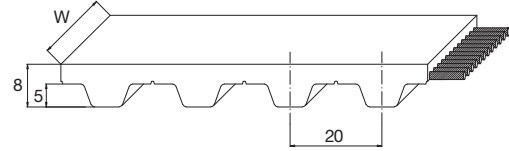

DL belt available only with standard steel, HF and standard stainless cord.

TOOTH RESISTANCE

RPM (1/min)	0	20	40	60	80	100	200	300	400	500	750	1000	1500	2000	3000	4000	5000	8000
F _{p spec} (N/cm)	102	98	95	93	91	89	81	76	72	68	62	57	50	45	38	33	29	-

TRACTION RESISTANCE

Belt width (mm)	25		32		50		75		100		150	
	M.T.L.	B.S.	M.T.L.	B.S.	M.T.L.	B.S.	M.T.L.	B.S.	M.T.L.	B.S.	M.T.L.	B.S.
Steel	3155	12635	4285	17145	6990	27975	11400	43320	15200	57760	25525	89345
Kevlar	2035	8150	2775	11115	4630	18525	7605	28895	10335	39270	17145	60020
HP	4515	18075	6160	24650	10270	41085	16865	64095	22920	87105	38035	133120
HF	3520	14095	4780	19130	7800	31215	12720	48335	16960	64445	28480	99690
HPF	5025	20115	6855	27430	11425	45715	18765	71320	25505	96920	42320	148125
Stainless	2510	10040	3405	13625	5555	22230	9060	34425	12080	45900	20285	71005
HP stainless	3840	15360	5235	20945	8725	34910	14330	54460	19475	74010	32315	113115

Average values in N (M.T.L.=Max Traction Load, B.S.=Breaking Strength)

FLEXION RESISTANCE

	Z _{min}	Z _{minDL}	Outside idler (mm)	Inside idler (mm)
Steel	15	25	120	120
Kevlar	15	-	120	120
HP	20	-	150	150
HF	15	25	120	120
HPF	18	-	120	120
Stainless	20	28	130	130
HP stainless	24	-	160	160

PULLEYS (for more details please see our pulley catalogue)

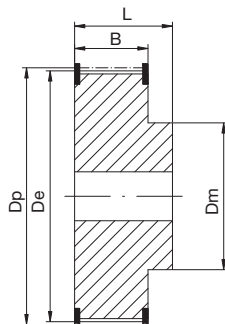

N° of teeth	Dp	De	N° of teeth	Dp	De
15	95,49	92,69	30	190,99	188,13
18	114,59	111,73	32	203,72	200,86
20	127,32	124,47	36	229,18	226,33
22	140,06	137,20	40	254,65	251,80
24	152,79	149,93	48	305,58	302,73
25	159,15	156,30	60	381,97	379,12

BELT CHARACTERISTICS

STANDARD WIDTHS (mm)	10	16	25	32	50	75	100	150
Weight for standard belt (gr/m)	37	59	92	117	183	275	367	550
Weight for DL belt (gr/m)	43	68	107	137	213	320	427	640

Standard compound: **white polyurethane thermoplastic 92ShA**

Standard back cover: **none**

Standard tooth cover: **none**

Standard cord: **zinc plated steel**

Standard width tolerance: **+/-0,5 mm**

Standard thickness tolerance: **+/-0,2 mm**

Standard length: **from 1500 mm (1900 mm with NFT) till 22770 mm**

Standard length tolerance: See page 29

Special version belt on request: See page 42

Tooth profile according ISO 17396.

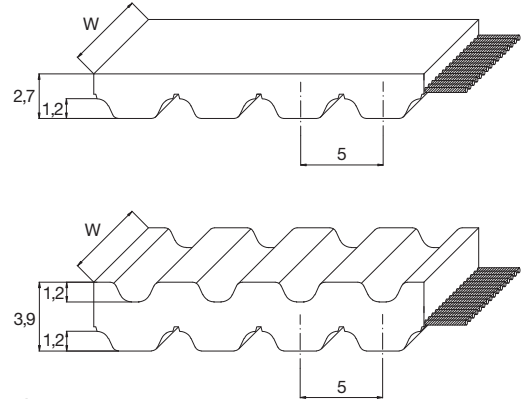

DL belt available only with standard steel, HF and standard stainless cord.

TOOTH RESISTANCE

RPM (1/min)	0	20	40	60	80	100	200	300	400	500	750	1000	1500	2000	3000	4000	5000	8000
F _{p spec} (N/cm)	35	35	35	34	34	34	32	31	30	29	27	26	24	22	19	18	16	13

TRACTION RESISTANCE

Belt width (mm)	10		16		25		32		50		75		100		150	
	M.T.L.	B.S.	M.T.L.	B.S.	M.T.L.	B.S.	M.T.L.	B.S.	M.T.L.	B.S.	M.T.L.	B.S.	M.T.L.	B.S.	M.T.L.	B.S.
Steel	570	2290	1015	4070	1715	6870	2225	8910	3560	14255	5760	21895	7705	29275	12655	44300
Kevlar	640	2565	1280	5130	2180	8720	2820	11285	4615	18465	7425	28215	9990	37960	16560	57965
HP	495	1995	995	3990	1695	6780	2195	8775	3590	14360	5775	21945	7770	29525	12880	45085
HF	530	2135	950	3800	1600	6410	2075	8310	3325	13300	5375	20425	7185	27310	11805	41325
HPF	520	2090	1045	4180	1775	7105	2295	9195	3760	15045	6050	22990	8140	30930	13495	47230
Stainless	470	1880	835	3340	1410	5640	1825	7310	2925	11700	4730	17970	6325	24035	10390	36365
HP stainless	400	1615	805	3230	1370	5490	1775	7105	2905	11625	4675	17765	6290	23900	10425	36495

Average values in N (M.T.L.=Max Traction Load, B.S.=Breaking Strength)

FLEXION RESISTANCE

	Z _{min}		Z _{minDL}		Outside idler (mm)	Inside idler (mm)
	Z _{min}	Z _{minDL}	Z _{min}	Z _{minDL}		
Steel	15	18	60	25		
Kevlar	15	-	60	25		
HP	25	-	80	80		
HF	12	15	40	25		
HPF	20	-	70	70		
Stainless	18	22	65	60		
HP stainless	25	-	80	80		

PULLEYS (for more details please see our pulley catalogue)

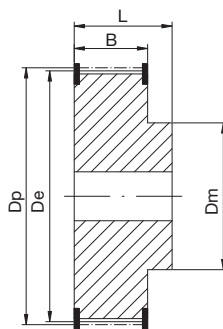

N° of teeth	Dp	De	N° of teeth	Dp	De
12	19,10	17,87	28	44,56	43,33
15	23,87	22,64	32	50,93	49,70
16	25,46	24,24	36	57,30	56,07
18	28,65	27,42	40	63,66	62,43
20	31,83	30,60	42	66,85	65,62
22	35,01	33,79	44	70,03	68,80
24	38,20	36,97	48	76,39	75,17
25	39,79	38,56	60	95,49	94,27

MEGAFLEX AT10 - AT10 DL

BELT CHARACTERISTICS

STANDARD WIDTHS (mm)	12	16	25	32	50	75	100	150
Weight for standard belt (gr/m)	72	97	150	190	300	450	600	900
Weight for DL belt (gr/m)	94	117	195	234	390	585	780	1170

Standard compound: **white polyurethane thermoplastic 92ShA**

Standard back cover: **none**

Standard tooth cover: **none**

Standard cord: **zinc plated steel**

Standard width tolerance: **+/-0,5 mm**

Standard thickness tolerance: **+/-0,3 mm**

Standard length: **from 1500 mm (1900 mm with NFT) till 22770 mm**

Standard length tolerance: See page 29

Standard length tolerance for HP, HPF, HP stainless, kevlar: **+0/-1 mm/m**

Special version belt on request: See page 42

Tooth profile according ISO 17396.

DL belt available only with standard steel, HF and standard stainless cord.

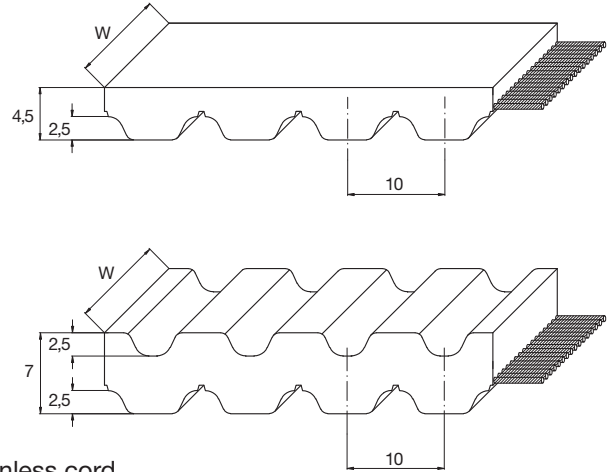

TOOTH RESISTANCE

RPM (1/min)	0	20	40	60	80	100	200	300	400	500	750	1000	1500	2000	3000	4000	5000	8000
F _{p spec} (N/cm)	74	72	71	71	70	69	65	62	60	58	53	50	44	40	35	30	27	20

TRACTION RESISTANCE

Belt width (mm)	12		16		25		32		50		75		100		150	
	M.T.L.	B.S.	M.T.L.	B.S.	M.T.L.	B.S.	M.T.L.	B.S.	M.T.L.	B.S.	M.T.L.	B.S.	M.T.L.	B.S.	M.T.L.	B.S.
Steel	1350	5415	1805	7220	3155	12635	4285	17145	6990	27975	11400	43320	15200	57760	25525	89345
Kevlar	1405	5620	2105	8435	3865	15465	5270	21090	8785	35150	14430	54830	19610	74515	32535	113885
HP	1640	6570	2465	9860	4515	18075	6160	24650	10270	41085	16865	64095	22920	87105	38035	133120
HF	1510	6040	2010	8055	3520	14095	4780	19130	7800	31215	12720	48335	16960	64445	28480	99690
HPF	1825	7315	2740	10970	5025	20115	6855	27430	11425	45715	18765	71320	25505	96920	42320	148125
Stainless	1075	4300	1430	5735	2510	10040	3405	13625	5555	22230	9060	34425	12080	45900	20285	71005
HP stainless	1395	5585	2090	8375	3840	15360	5235	20945	8725	34910	14330	54460	19475	74010	32315	113115

Average values in N (M.T.L.=Max Traction Load, B.S.=Breaking Strength)

FLEXION RESISTANCE

	Z _{min}	Z _{minDL}	Outside idler (mm)	Inside idler (mm)
Steel	15	25	120	50
Kevlar	15	-	120	50
HP	25	-	150	80
HF	15	25	80	50
HPF	16	-	100	60
Stainless	19	28	130	130
HP stainless	26	-	150	150

PULLEYS (for more details please see our pulley catalogue)

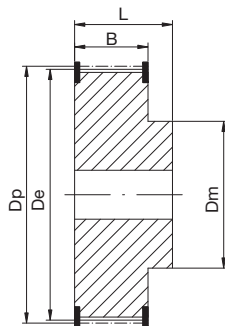

N° of teeth	Dp	De	N° of teeth	Dp	De
15	47,75	45,90	28	89,13	87,28
16	50,93	49,08	30	95,49	93,65
18	57,30	55,45	32	101,86	100,01
19	60,48	58,63	36	114,59	112,74
20	63,66	61,81	40	127,32	125,48
22	70,03	68,18	44	140,06	138,21
24	76,39	74,55	48	152,79	150,94
26	82,76	80,91	60	190,99	189,14

BELT CHARACTERISTICS

STANDARD WIDTHS (mm)	32	50	75	100	150
Weight for standard belt (gr/m)	363	567	750	1133	1700

Standard compound: **white polyurethane thermoplastic 92ShA**

Standard back cover: **none**

Standard tooth cover: **none**

Standard cord: **S&Z zinc plated steel**

Standard width tolerance: **+/-1 mm**

Standard thickness tolerance: **+/-0,45 mm**

Standard length: **from 1500 mm (1905 mm with NFT) till 22770 mm**

Standard length tolerance: **- 0,5 / -1,5 mm/m**

Special version belt on request: See page 42

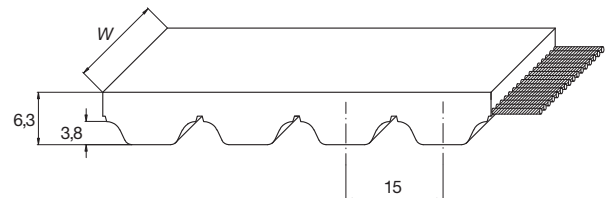

Tooth profile according ISO 17396.

TOOTH RESISTANCE

RPM (1/min)	0	20	40	60	80	100	200	300	400	500	750	1000	1500	2000	3000	4000	5000	8000
$F_{p\ spec}$ (N/cm)	110	109	106	104	102	101	94	87	84	80	72	66	57	50	39	32	26	-

TRACTION RESISTANCE

Belt width (mm)	32		50		75		100		150	
	M.T.L.	B.S.	M.T.L.	B.S.	M.T.L.	B.S.	M.T.L.	B.S.	M.T.L.	B.S.
Steel	9120	36480	14440	57760	23200	88160	31200	118560	51245	179360

Average values in N (M.T.L.=Max Traction Load, B.S.=Breaking Strength)

FLEXION RESISTANCE

	Z_{min}	Outside idler (mm)	Inside idler (mm)
Steel	25	250	120

PULLEYS (for more details please see our pulley catalogue)

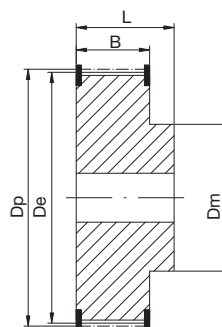

N° of teeth	Dp	De
25	119,37	116,89
28	133,69	131,21
30	143,24	140,76
34	162,34	159,86
40	190,99	188,51
42	200,54	198,05
48	229,18	226,70
54	257,83	255,35
60	286,48	284,00

MEGAFLEX AT20 - AT20 DL

BELT CHARACTERISTICS

STANDARD WIDTHS (mm)	25	32	50	75	100	150
Weight for standard belt (gr/m)	250	320	500	750	1000	1500
Weight for DL belt (gr/m)	317	405	633	950	1267	1900

Standard compound: **white polyurethane thermoplastic 92ShA**

Standard back cover: **none**

Standard tooth cover: **none**

Standard cord: **zinc plated steel**

Standard width tolerance: **+/-1 mm**

Standard thickness tolerance: **+/-0,45 mm**

Standard length: **from 1500 mm (1900 mm with NFT) till 22760 mm**

Standard length tolerance: See page 29

Standard length tolerance for HP, HP stainless, kevlar: **+0/-0,8 mm/m**

Special version belt on request: See page 42

Tooth profile according ISO 17396.

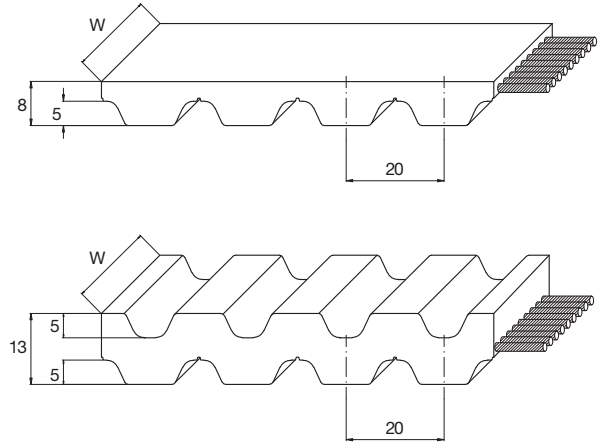

DL belt available only with standard steel, HF and standard stainless cord.

TOOTH RESISTANCE

RPM (1/min)	0	20	40	60	80	100	200	300	400	500	750	1000	1500	2000	3000	4000	5000	8000
F _{p spec} (N/cm)	147	144	142	139	137	135	126	119	112	107	97	88	76	67	58	43	35	-

TRACTION RESISTANCE

Belt width (mm)	25		32		50		75		100		150	
	M.T.L.	B.S.	M.T.L.	B.S.	M.T.L.	B.S.	M.T.L.	B.S.	M.T.L.	B.S.	M.T.L.	B.S.
Steel	4515	18075	6160	24650	10270	41085	16865	64095	22920	87105	38035	133120
Kevlar	2810	11245	3515	14060	6325	25305	10360	39365	14060	53425	23295	81545
HP	6080	24320	7600	30400	13680	54720	22400	85120	30400	115520	50375	176320
HF	5025	20115	6855	27430	11425	45715	18765	71320	25505	96920	42320	148125
Stainless	3840	15360	5235	20945	8725	34910	14330	54460	19475	74010	32315	113115
HP Stainless	4275	17100	5340	21375	9615	38475	15750	59850	21375	81225	35420	123975

Average values in N (M.T.L.=Max Traction Load, B.S.=Breaking Strength)

FLEXION RESISTANCE

	Z _{min}	Z _{minDL}	Outside idler (mm)	Inside idler (mm)
Steel	18	25	180	120
Kevlar	18	-	180	120
HP	25	-	250	160
HF	18	25	150	120
Stainless	20	26	200	150
HP stainless	26	-	260	180

PULLEYS (for more details please see our pulley catalogue)

N° of teeth	Dp		De		
	Dp	De	Dp	De	
18	114,59	111,73	32	203,72	200,86
20	127,32	124,47	36	229,18	226,33
22	140,06	137,20	40	254,65	251,80
24	152,79	149,93	48	305,58	302,73
25	159,15	156,30	60	381,97	379,12
30	190,99	188,13			

BELT CHARACTERISTICS

STANDARD WIDTHS (mm)	15	20	30	50	85	100	150
Weight for standard belt (gr/m)	90	120	180	300	510	600	900

Standard compound:	white polyurethane thermoplastic 92ShA
Standard back cover	none
Standard tooth cover	none
Standard cord	zinc plated steel
Standard width tolerance	+/-0,5 mm
Standard thickness tolerance	+/-0,3 mm
Standard length	from 1504 mm (1904 mm with NFT) till 22768 mm
Standard length tolerance	See page 29
Special version belt on request	See page 42
Tooth profile according ISO 13050	

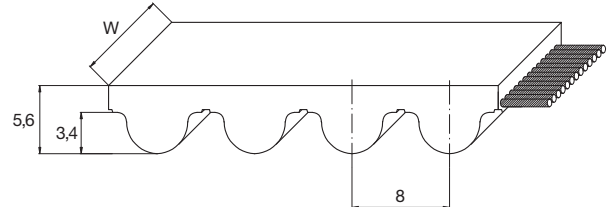

TOOTH RESISTANCE

RPM (1/min)	0	20	40	60	80	100	200	300	400	500	750	1000	1500	2000	3000	4000	5000	8000
$F_{p\ spec}$ (N/cm)	67	66	65	64	63	63	59	57	54	52	48	45	40	37	31	28	24	18

TRACTION RESISTANCE

Belt width (mm)	15		20		30		50		85		100		150	
	M.T.L.	B.S.	M.T.L.	B.S.	M.T.L.	B.S.	M.T.L.	B.S.	M.T.L.	B.S.	M.T.L.	B.S.	M.T.L.	B.S.
Steel	895	3590	1295	5185	2090	8375	3590	14360	6615	25135	7665	29125	12880	45085
Kevlar	1150	4615	1665	6665	2690	10770	4615	18465	8505	32315	9990	37960	16560	57965
HF	940	3760	1355	5430	2190	8775	3760	15045	6930	26330	8030	30510	13495	47230
Stainless	725	2905	1045	4195	1695	6780	2905	11625	5085	20345	5890	23575	9120	36495

Average values in N (M.T.L.=Max Traction Load, B.S.=Breaking Strength)

FLEXION RESISTANCE

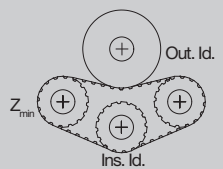

	Z_{min}	Outside idler (mm)	Inside idler (mm)
Steel	20	80	40
Kevlar	20	100	50
HF	20	80	40
Stainless	24	110	80

PULLEYS (for more details please see our pulley catalogue)

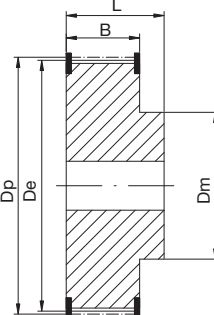

N° of teeth	Dp	De	N° of teeth	Dp	De
20	50,93	49,58	44	112,05	110,67
22	56,02	54,65	48	122,23	120,86
24	61,12	59,75	56	142,60	141,23
26	66,21	64,84	64	162,97	161,60
28	71,30	70,08	72	183,35	181,97
32	81,49	80,16	112	285,21	283,83
36	91,67	90,30	144	366,69	365,32
40	101,86	100,49			

MEGAFLEX RPP5 - RPP5 DL

BELT CHARACTERISTICS

STANDARD WIDTHS (mm)	10	15	25	30	50	85	100	150
Weight for standard belt (gr/m)	43	64	85	128	213	363	427	640
Weight for DL belt (gr/m)	47	71	118	142	237	402	473	710

Standard compound: **white polyurethane thermoplastic 92ShA**
 Standard back cover: **none**
 Standard tooth cover: **Nylon fabric (NFT)**
 Standard cord: **zinc plated steel**
 Standard width tolerance: **+/-0,5 mm**
 Standard thickness tolerance: **+/-0,2 mm**
 Standard length: **1900 mm till 22770 mm**
 Standard length tolerance: See page 29
 Special version belt on request: See page 42
 Tooth profile according ISO 13050
 DL belt available only with standard steel, HF and standard stainless cord.

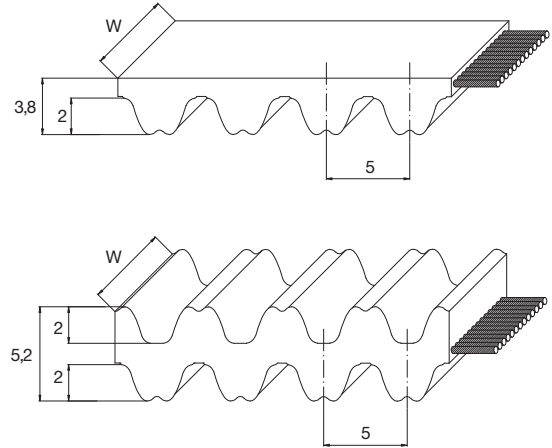

TOOTH RESISTANCE

RPM (1/min)	0	20	40	60	80	100	200	300	400	500	750	1000	1500	2000	3000	4000	5000	8000
F _{p spec} (N/cm)	37	36	36	36	35	35	33	32	30	30	27	26	24	23	21	19	18	15

TRACTION RESISTANCE

Belt width (mm)	10		15		25		30		50		85		100		150	
	M.T.L.	B.S.	M.T.L.	B.S.	M.T.L.	B.S.	M.T.L.	B.S.	M.T.L.	B.S.	M.T.L.	B.S.	M.T.L.	B.S.	M.T.L.	B.S.
Steel	570	2290	950	3815	1715	6870	2100	8400	3560	14255	6235	24950	7315	29275	11655	44300
HF	530	2135	890	3560	1600	6410	1955	7835	3325	13300	5815	23275	6825	27310	10875	41325
Stainless	470	1880	780	3135	1410	5640	1720	6895	2925	11700	5120	20480	6005	24035	9570	36365

Average values in N (M.T.L.=Max Traction Load, B.S.=Breaking Strength)

FLEXION RESISTANCE

	Z _{min}	Z _{minDL}	Outside idler (mm)	Inside idler (mm)
Steel	15	18	60	25
HF	15	18	40	25
Stainless	18	22	65	65

PULLEYS (for more details please see our pulley catalogue)

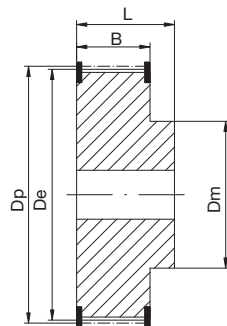

N° of teeth	Dp	De	N° of teeth	Dp	De
15	23,87	22,73	30	47,75	46,60
16	25,46	24,32	32	50,93	49,79
18	28,65	27,50	36	57,30	56,15
20	31,83	30,69	40	63,66	62,52
22	35,01	33,87	44	70,03	68,89
24	38,20	37,05	48	76,39	75,25
26	41,38	40,24	60	95,49	94,35
28	44,56	43,42	72	114,59	113,45

BELT CHARACTERISTICS

STANDARD WIDTHS (mm)	15	20	30	50	85	100	150
Weight for standard belt (gr/m)	98	131	196	327	555	653	980
Weight for DL belt (gr/m)	110	147	220	367	623	733	1100

Standard compound: **white polyurethane thermoplastic 92Sha**

Standard back cover: **none**

Standard tooth cover: **nylon fabric (NFT)**

Standard cord: **zinc plated steel**

Standard width tolerance: **+/-0,5 mm**

Standard thickness tolerance: **+/-0,3 mm**

Standard length: **1904 mm till 22768 mm**

Standard length tolerance: See page 29

Special version belt on request: See page 42

Tooth profile according ISO 13050

DL belt available only with standard steel, HF and standard stainless cord.

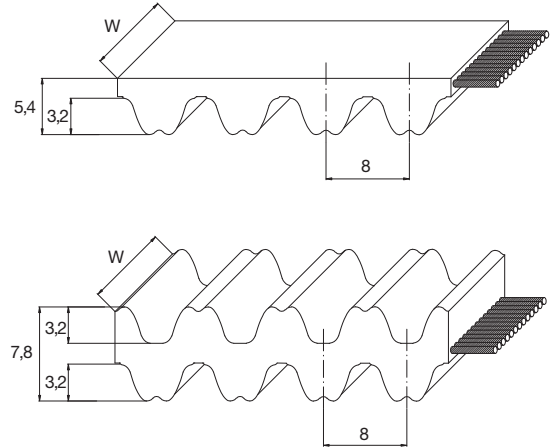

TOOTH RESISTANCE

RPM (1/min)	0	20	40	60	80	100	200	300	400	500	750	1000	1500	2000	3000	4000	5000	8000
F _{p spec} (N/cm)	76	75	74	73	72	71	65	62	60	57	53	50	45	42	38	35	32	25

TRACTION RESISTANCE

Belt width (mm)	15		20		30		50		85		100		150	
	M.T.L.	B.S.	M.T.L.	B.S.	M.T.L.	B.S.	M.T.L.	B.S.	M.T.L.	B.S.	M.T.L.	B.S.	M.T.L.	B.S.
Steel	1350	5415	2030	8120	3155	12635	5640	22560	10685	40610	12585	47830	20885	73100
Kevlar	2105	8435	3160	12650	4920	19680	8785	35150	16650	63270	19610	74515	32535	113885
HF	1510	6040	2265	9060	3520	14095	6290	25175	11925	45315	14045	53370	23300	81565
Stainless	1075	4300	1610	6455	2510	10040	17930	4480	8490	32275	10000	38010	16595	58095

Average values in N (M.T.L.=Max Traction Load, B.S.=Breaking Strength)

FLEXION RESISTANCE

	Z _{min}		Outside idler (mm)	Inside idler (mm)
	Z _{min}	Z _{minDL}		
Steel	18	25	100	45
Kevlar	18	-	100	45
HF	18	25	80	40
Stainless	20	28	110	60

PULLEYS (for more details please see our pulley catalogue)

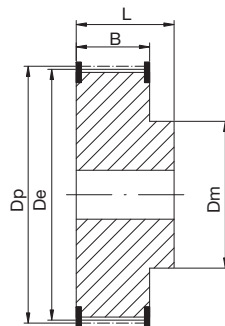

N° of teeth	Dp	De	N° of teeth	Dp	De
18	45,84	44,49	44	112,05	110,67
22	56,02	54,65	48	122,23	120,86
24	61,12	59,74	54	137,51	136,14
26	66,21	64,84	64	162,97	161,60
28	71,30	69,93	72	183,35	181,97
32	81,49	80,12	90	229,18	227,81
36	91,67	90,30	144	366,69	365,32
38	96,77	95,39	192	488,92	487,55

MEGAFLEX RPP14 - RPP14 DL

BELT CHARACTERISTICS

STANDARD WIDTHS (mm)	25	40	55	85	115	150
Weight for standard belt (gr/m)	308	493	678	1048	1418	1850
Weight for DL belt (gr/m)	350	560	770	1190	1610	2100

Standard compound: **white polyurethane thermoplastic 92Sha**
 Standard back cover: **none**
 Standard tooth cover: **Nylon fabric (NFT)**
 Standard cord: **zinc plated steel**
 Standard width tolerance: **+/-1 mm**
 Standard thickness tolerance: **+/-0,4 mm**
 Standard length: **1904 mm till 22764 mm**
 Standard length tolerance: See page 29
 Special version belt on request: See page 42
 Tooth profile according ISO 13050
 DL belt available only with standard steel and standard stainless cord.

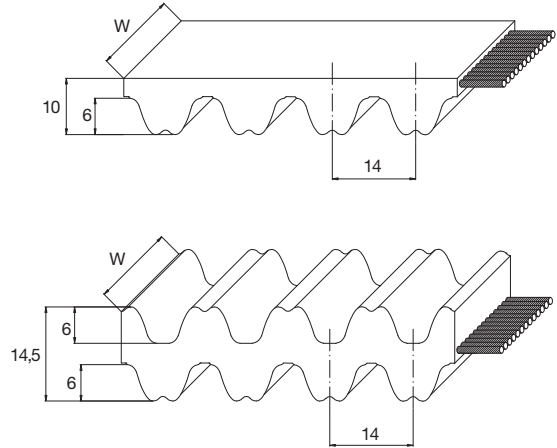

TOOTH RESISTANCE

RPM (1/min)	0	20	40	60	80	100	200	300	400	500	750	1000	1500	2000	3000	4000	5000	8000
F _{p spec} (N/cm)	140	137	135	133	131	128	118	111	105	101	91	84	75	62	52	40	30	-

TRACTION RESISTANCE

Belt width (mm)	25		40		55		85		115		150	
	M.T.L.	B.S.	M.T.L.	B.S.	M.T.L.	B.S.	M.T.L.	B.S.	M.T.L.	B.S.	M.T.L.	B.S.
Steel	6080	24320	10640	42560	16000	60800	26400	100320	39085	136800	52110	182400
Stainless	4275	17100	7480	29925	11250	42750	18560	70535	27480	96185	36640	128250

Average values in N (M.T.L.=Max Traction Load, B.S.=Breaking Strength)

FLEXION RESISTANCE

Belt width (mm)	Z _{min}		Z _{minDL}		Outside idler (mm)	Inside idler (mm)
	Steel	Stainless	Steel	Stainless		
25	32	38	40	44	250	145
40	32	38	40	44	250	145
55	32	38	40	44	250	145
85	32	38	40	44	250	145
115	32	38	40	44	250	145
150	32	38	40	44	250	145

PULLEYS (for more details please see our pulley catalogue)

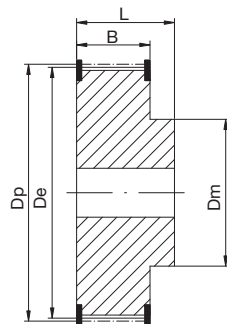

N° of teeth	Dp	De	N° of teeth	Dp	De
32	142,60	139,81	72	320,86	318,07
34	151,52	148,73	80	356,51	353,72
38	169,34	166,55	90	401,07	398,28
40	178,25	175,46	112	499,11	496,32
44	196,08	193,29	144	641,71	638,92
48	213,90	211,11	168	748,66	745,87
56	249,55	246,76	192	855,61	852,82
64	285,20	282,41	216	962,57	959,78

BELT CHARACTERISTICS

STANDARD WIDTHS (mm)	25	32	50	75	100	150
Weight for standard belt (gr/m)	180	220	330	480	630	930

Standard compound: **white polyurethane thermoplastic 92ShA**

Standard back cover: **none**

Standard tooth cover: **none**

Standard cord: **zinc plated steel**

Standard width tolerance: **+/-0,5 mm**

Standard thickness tolerance: **+/-0,3 mm**

Standard length: **from 1500 mm (1900 mm with NFT) till 22770 mm**

Standard length tolerance: See page 29

Special version belt on request: See page 42

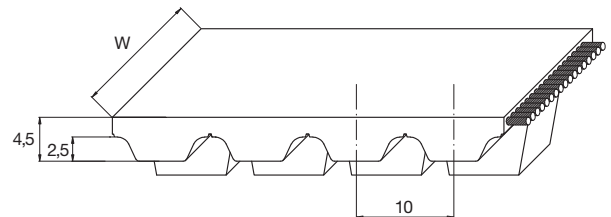
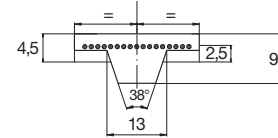

TOOTH RESISTANCE

RPM (1/min)	0	20	40	60	80	100	200	300	400	500	750	1000	1500	2000	3000	4000	5000	8000
F _{p spec} (N/cm)	74	72	71	71	70	69	65	62	60	58	53	50	44	40	35	30	27	20

TRACTION RESISTANCE

Belt width (mm)	25		32		50		75		100		150	
	M.T.L.	B.S.	M.T.L.	B.S.	M.T.L.	B.S.	M.T.L.	B.S.	M.T.L.	B.S.	M.T.L.	B.S.
Steel	3155	12635	4285	17145	6990	27975	11400	43320	15200	57760	25525	89345
Kevlar	2590	10370	3515	14075	5740	22970	9360	35565	12480	47420	20955	73355
HF	3520	14095	4780	19130	7800	31215	12720	48335	16960	64445	28480	99690
Stainless	2510	10040	3405	13625	5555	22230	9060	34425	12080	45900	20285	71005

Average values in N (M.T.L.=Max Traction Load, B.S.=Breaking Strength)

FLEXION RESISTANCE

	Z _{min}	Outside idler (mm)	Inside idler (mm)
Steel	25	120	100
Kevlar	25	120	100
HF	25	100	80
Stainless	31	130	130

PULLEYS (for more details please see our pulley catalogue)

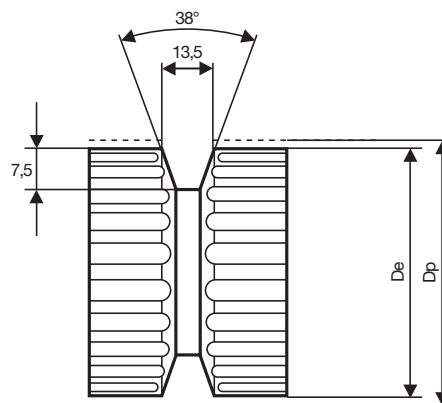

N° of teeth	Dp	De
25	79,58	77,73
27	85,94	84,10
30	95,49	93,65
32	101,86	100,01
36	114,59	112,74
40	127,32	125,48
48	152,79	150,94
60	190,99	189,14

MEGAFLEX P2

BELT CHARACTERISTICS

STANDARD WIDTHS (mm)	25	50	75	100	150
Weight for standard belt (gr/m)	105	210	315	420	630

Standard compound: **white polyurethane thermoplastic 92ShA**

Standard back cover: **none**

Standard tooth cover: **none**

Standard cord: **zinc plated steel**

Standard width tolerance: **+/-0,5 mm**

Standard thickness tolerance: **+/-0,3 mm**

Standard length: **from 1500 mm (1900 mm with NFT) till 22770 mm**

Standard length tolerance: See page 29

Special version belt on request: See page 42

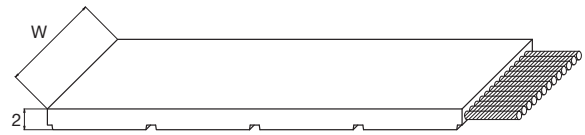

TRACTION RESISTANCE

Belt width (mm)	25		50		75		100		150	
	M.T.L.	B.S.	M.T.L.	B.S.	M.T.L.	B.S.	M.T.L.	B.S.	M.T.L.	B.S.
Steel	1125	4510	2255	9025	3800	14440	5460	20755	9025	31585
Stainless	895	3585	1790	7170	3020	11475	4340	16495	7170	25100

Average values in N (M.T.L.=Max Traction Load, B.S.=Breaking Strength)

FLEXION RESISTANCE

	Diam min	Outside idler (mm)	Inside idler (mm)
Steel	45	90	50
Stainless	60	150	80

PULLEYS (for more details please see our pulley catalogue)

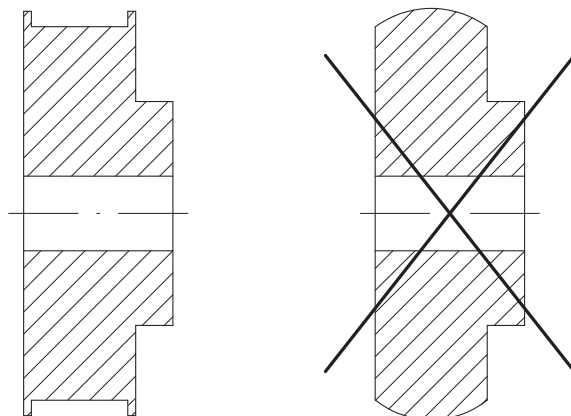

Not suggested

LENGTH TOLERANCES

MEGAFLEX are custom made manufactured belts, they are available tooth by tooth on the following range:
from 1500 mm to 22770 mm length

from 1900 mm to 22770 mm length for nylon fabric teeth version

For AT10 and AT20 with HP, HPF and Kevlar cords and for AT15, check length tolerance on belt data pages 20, 21 and 22.

LENGTH TOLERANCES (mm)							
UP TO		UP TO		UP TO		UP TO	
1700 mm	± 1,13	3150 mm	± 1,74	5600 mm	± 2,72	12000 mm on request	
1900 mm	± 1,22	3350 mm	± 1,82	6000 mm	± 2,92	13000 mm on request	
2120 mm	± 1,31	3550 mm	± 1,91	6300 mm	± 3,04	14000 mm on request	
2240 mm	± 1,36	3750 mm	± 2,03	6700 mm	± 3,19	15000 mm on request	
2360 mm	± 1,44	4000 mm	± 2,11	7100 mm	± 3,35	16000 mm on request	
2500 mm	± 1,49	4250 mm	± 2,24	7500 mm	± 3,51	17000 mm on request	
2650 mm	± 1,57	4500 mm	± 2,32	8000 mm	± 3,70	18000 mm on request	
2800 mm	± 1,61	4750 mm	± 2,40	9000 mm	± 4,09	19000 mm on request	
3000 mm	± 1,70	5300 mm	± 2,64	11000 mm	± 4,80	20000 mm on request	

The above length tolerance are tested with following system.

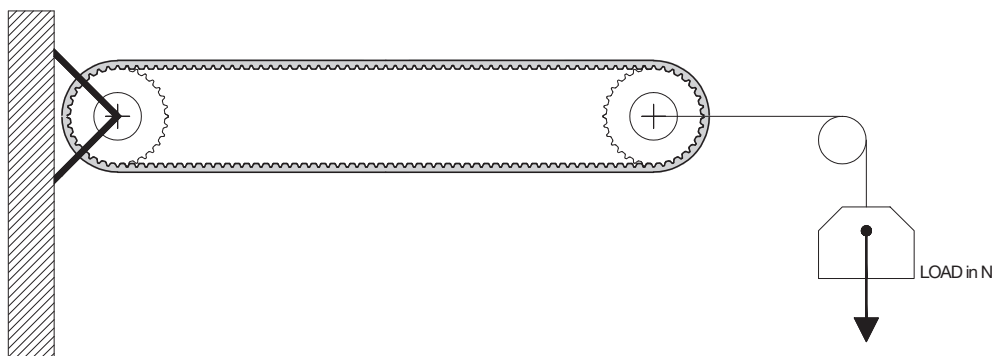

TYPE	WIDTH (mm)	MEASURING LOAD IN N FOR BELT WIDTH										
		6	10	12	16	20	25	32	50	75	100	150
T5		20	40		60		90	120	190	280		
T10					90		140	170	270	420		
T20							265	340	540	800	1100	
AT5			50		80		125	160	250	375		
AT10							270	340	540	800	1100	
AT15								640	1030	1570	2100	3150
AT20								500	800	1200	1600	
MTD8					170		270		540			
RPP5			50				94		240			
RPP8					170	220	270		540			
RPP14							800		1300			

TYPE	WIDTH (mm)	12,7	19,05	25,4	38,1	50,8	76,2	101,6	152,4
XL		40	69	90	140				
L		63	94	125	180				
H				140	200	260			
XH					600	800	1200		

Special length tolerance on request.

CLEATS

Megadyne timing belts can be customised with profiles welded on the backside. All the cleats are made using the same thermoplastic polyurethane as the MEGAFLEX body (white PU 92 ShA).

The profiles are attached with the best technology available, the High Vibration System.

The production process for these profiles is very flexible; Megadyne can design any profile to meet the specific requirement of the customer, in order to check and develop all the needed special profiles.

STANDARD PARALLELEPIPED PROFILES

Megadyne can produce, as standard cleats, the parallelepiped profiles, starting from a thermoplastic polyurethane strip roll and cutting until the requested profile dimension.

The t value (thickness) is available from 2 until 13 mm, the h value (height) can be from 3 until 120 mm and the width can be 150 mm maximum.

Megadyne recommends that the profile spacing is multiple of the belt pitch; in any case, for special inquiries and small quantities, it is possible to weld the profiles also in others positions; the feasible dimensions, with the standard process tolerances, are introduced in the following sketch.

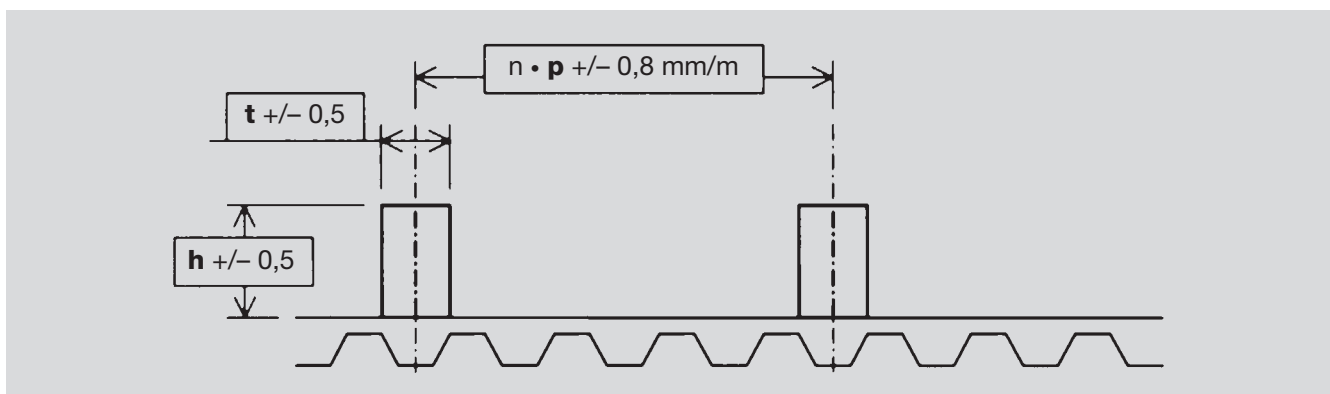

The tolerances on the position are $\pm 0,5$ mm.

The cumulative tolerance on the spacing of the profiles is the same of the length tolerance for our standard belts ($\pm 0,8$ mm/m) (tighter tolerances are available on request).

Due to the welding process, a bead of material develops at the meeting point of the profile and belt.

In any case, Megadyne always remove this welding bead.

PROFILE MECHANICAL RESISTANCE

In order to find the right cleat dimensions, please consider the following factors:

- Section base cleats resistance (**R**) becomes bigger, increasing:
 - Cleats width (**w**)
 - Cleats thickness (**t**)

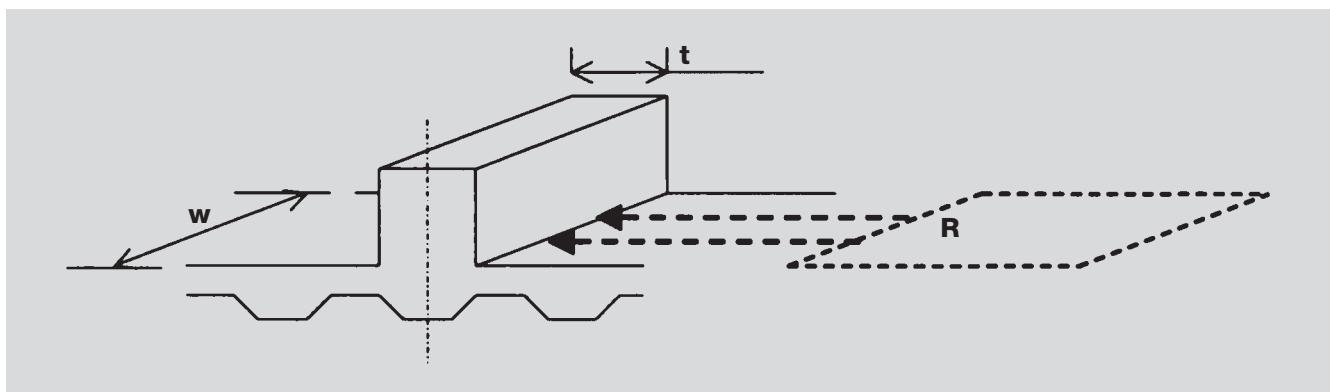

- Cleat stiffness is bigger:
 - Increasing cleat thickness (**t**)
 - Using special moulded profiles, like STDE0006, STDE0008, STDE0010 and STMI0012 types

MIN. N° OF PULLEY TEETH FOR BELTS WITH PROFILES

The profiles presence can change the belt flexibility properties; the two factors that affect the original flexibility are the following:

- Thickness of the cleat “foot” (size of the base). Flexibility decreases when welded area dimensions increase.
- Position of the welded profile on the belt. When the cleats are welded in axis with the teeth, belt flexibility is better than when cleats are welded in axis with the little nose.

Please find, in the following table, flexibility properties for the cleated belts.

MINIMUM NUMBER OF PULLEY TEETH													
CLEATS OVER A TOOTH							CLEATS NOT OVER A TOOTH						
CLEATS THICKNESS	4	5	6	8	10	12	CLEATS THICKNESS	4	5	6	8	10	12
XL	18	18	25	40	50	100	XL	45	45	50	60	100	-
L	12	12	18	30	40	60	L	40	40	45	55	60	80
H	14	14	14	18	25	45	H	25	25	30	45	50	65
XH	18	18	18	18	18	20	XH	20	20	30	40	45	54
T5 / AT5	18	18	25	40	50	100	T5 / AT5	45	45	50	60	100	-
T10 / AT10	14	14	14	18	25	45	T10 / AT10	30	30	40	45	50	65
AT15	16	16	16	18	25	40	AT15	20	20	30	40	45	54
T20 / AT20	18	18	18	18	18	20	T20 / AT20	20	20	30	40	45	54
RPP5	18	18	25	40	50	100	RPP5	45	45	50	60	100	-
RPP8 / MTD8	14	14	14	18	25	45	RPP8 / MTD8	30	30	40	45	50	65
RPP14	18	18	18	18	18	20	RPP14	20	20	30	40	45	54

STANDARD PARALLELEPIPED PROFILES WITH HOLES

Parallelepiped profiles are available also with holes, to satisfy specials applications; please find below the standard tolerances for this kind of cleats.

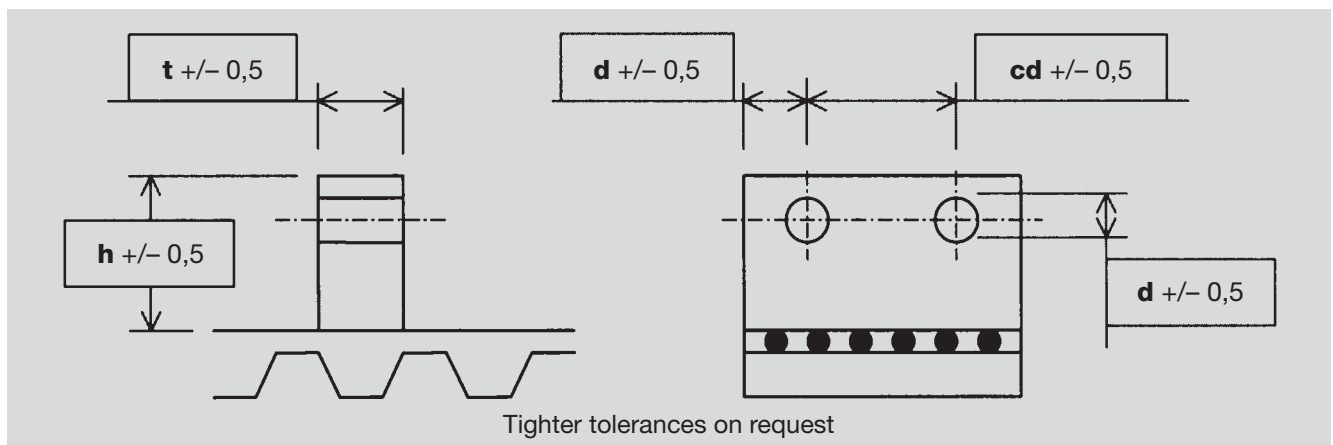

For belt flexibility and mechanical resistance, please kindly refer to values for cleats without holes.

MOULDED CLEATS

Using a high performance injection system, Megadyne can produce any profile designed by the customer. For cleats not yet present in following pages, Megadyne can produce dedicated mould according customer requirements. For belt flexibility and mechanical resistance, please kindly refer to standard parallelepiped profile section.

CLEATS

SPECIAL CLEATS DRAWING LIST

If the needed cleat wouldn't yet present in the following tables, please contact MEGADYNE staff.

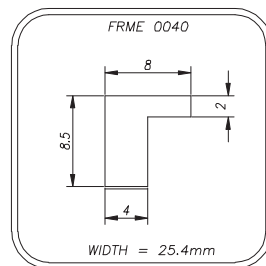
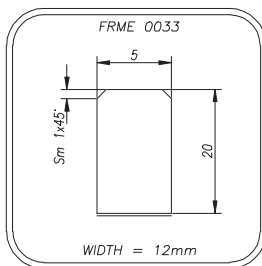
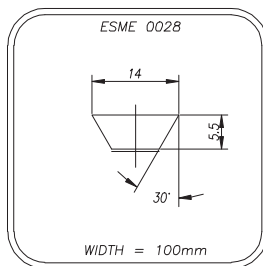
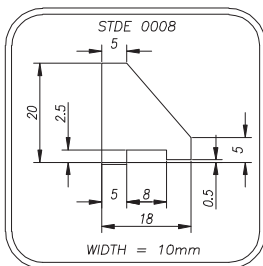
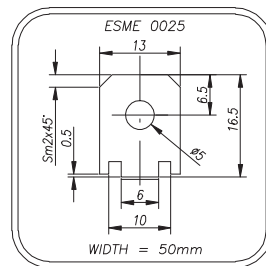
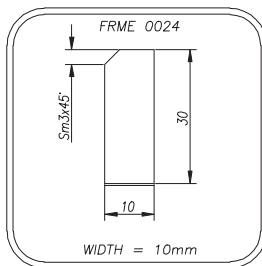
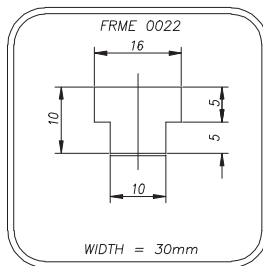
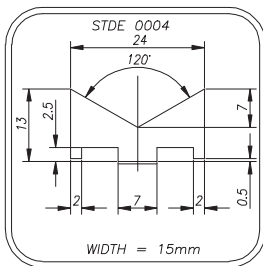
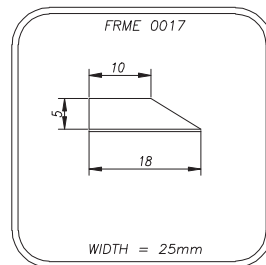
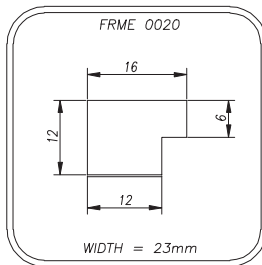
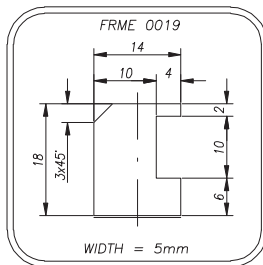
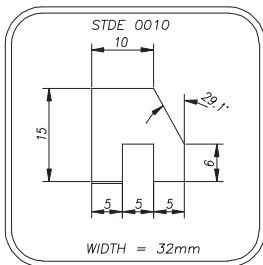
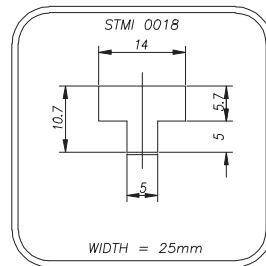
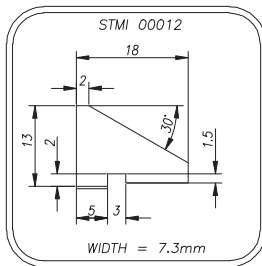
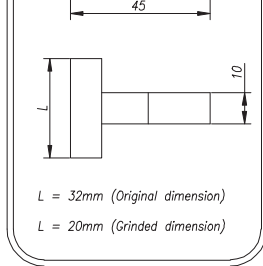
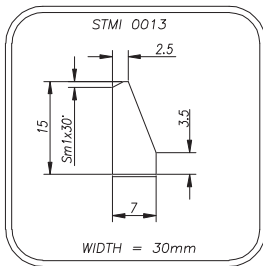
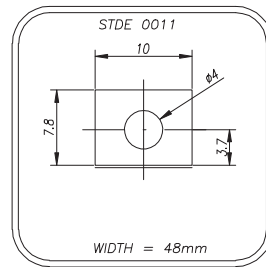
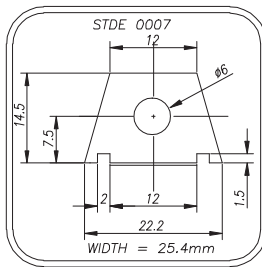
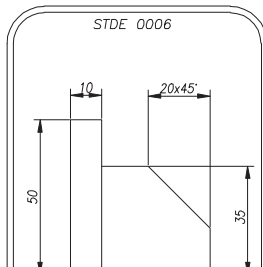
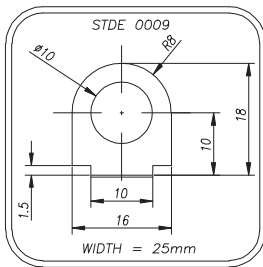
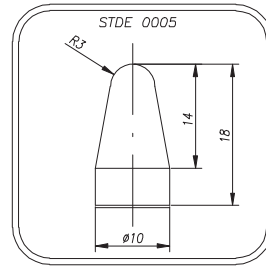
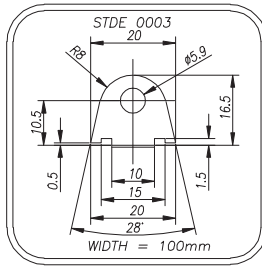
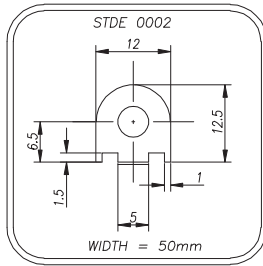
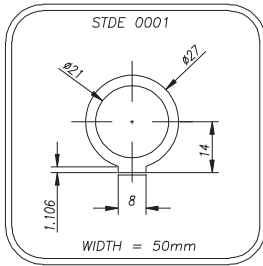

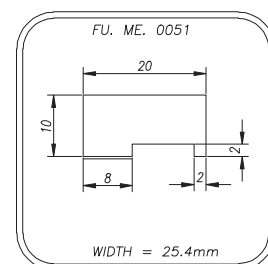
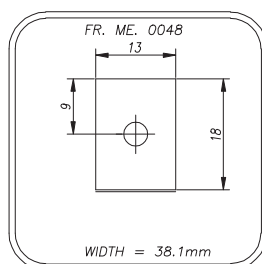
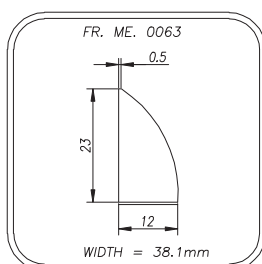
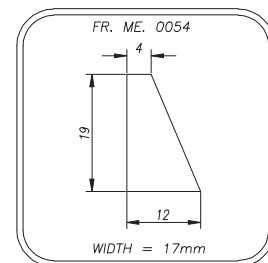
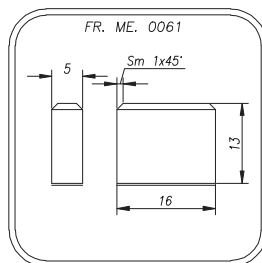
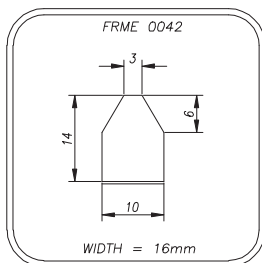
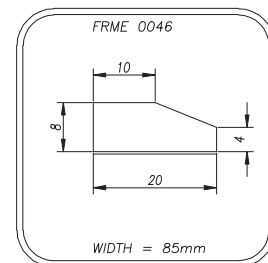
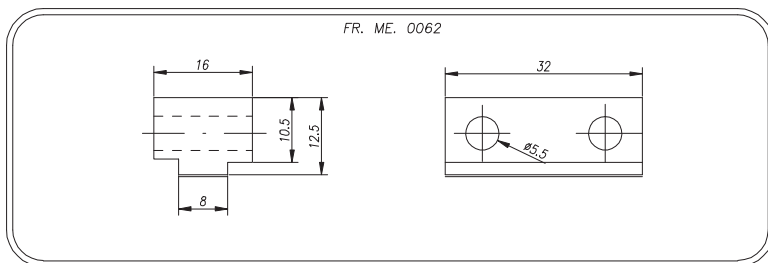
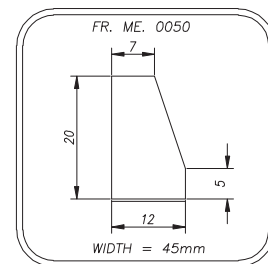
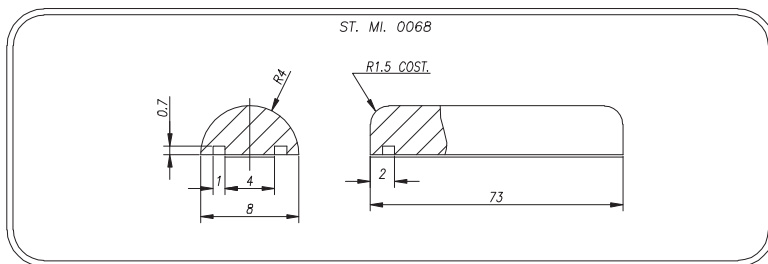
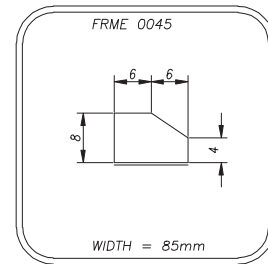
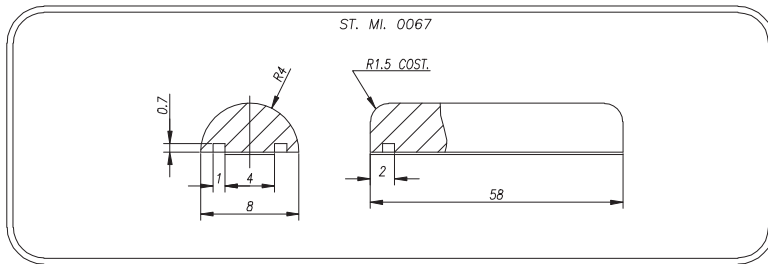
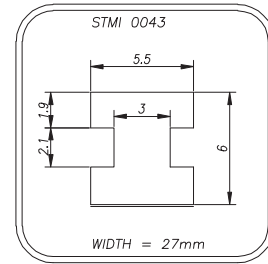
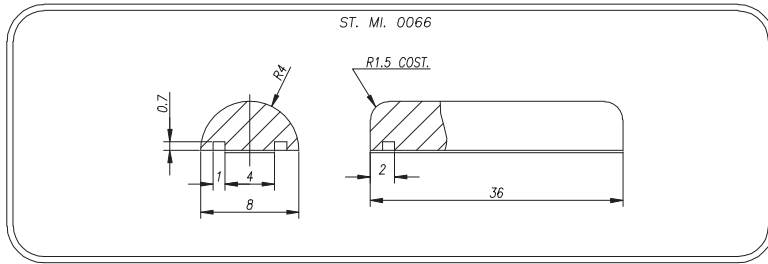

CLEATS

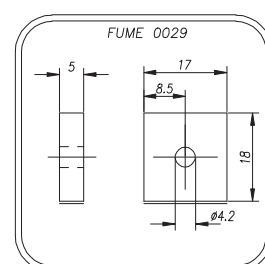
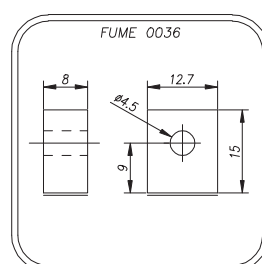
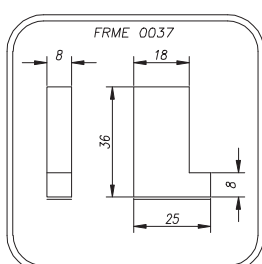
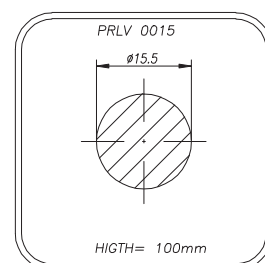
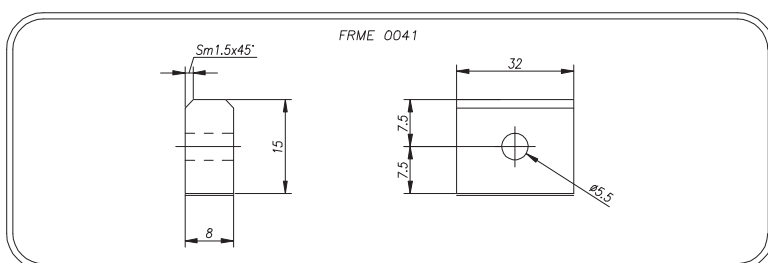
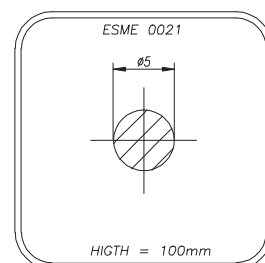
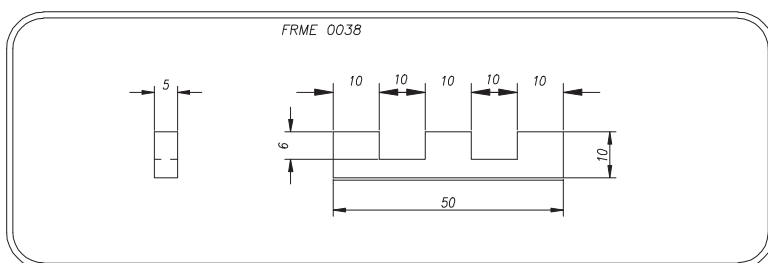
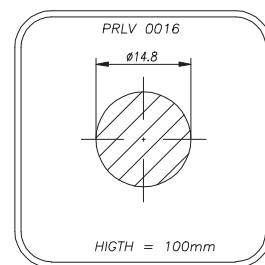
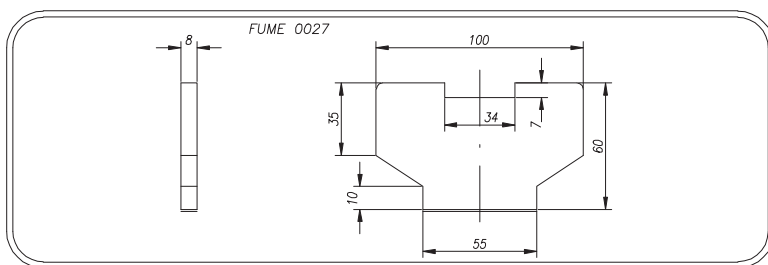
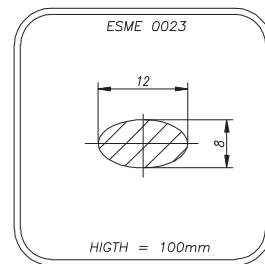
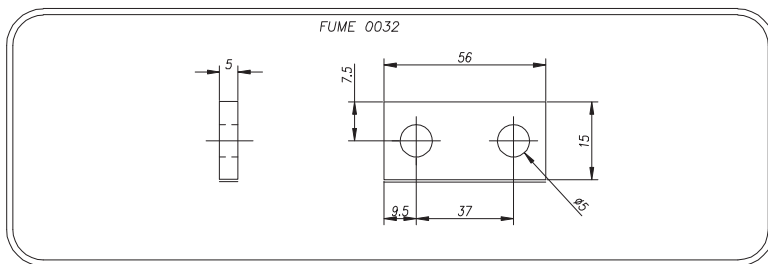
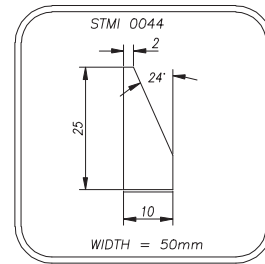
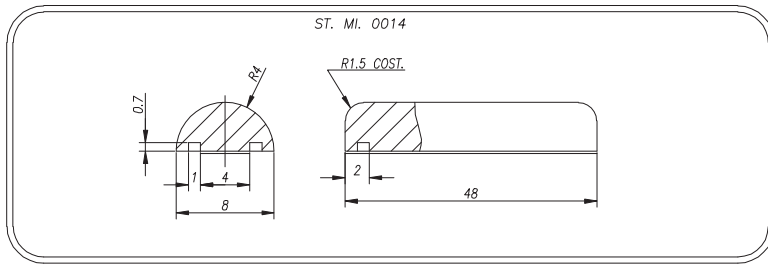

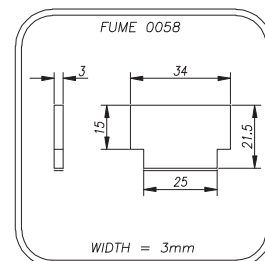
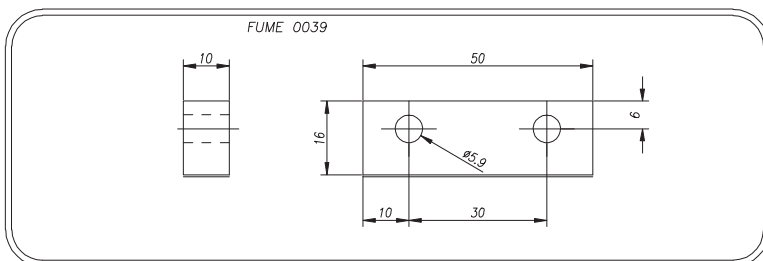
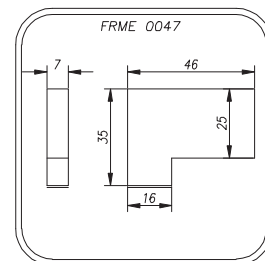
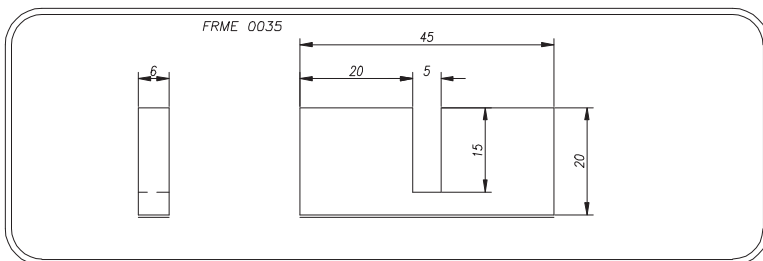
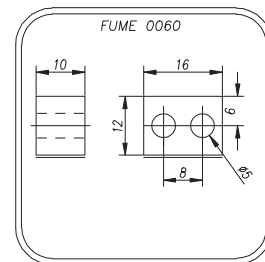
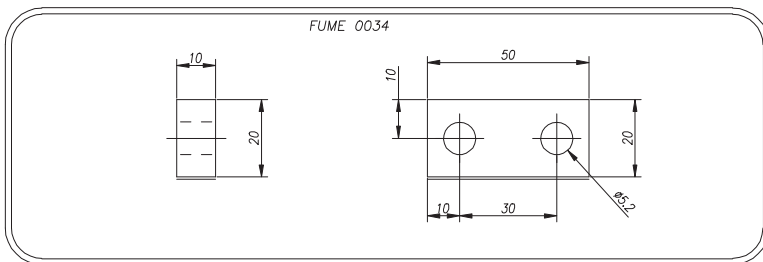
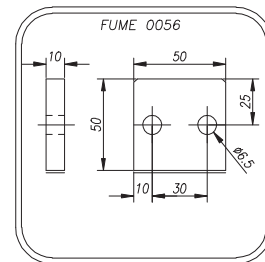
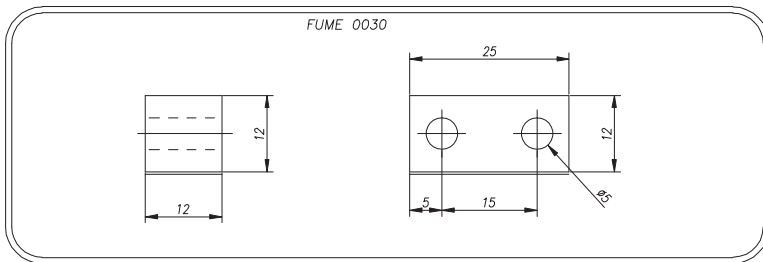
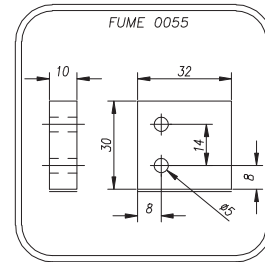
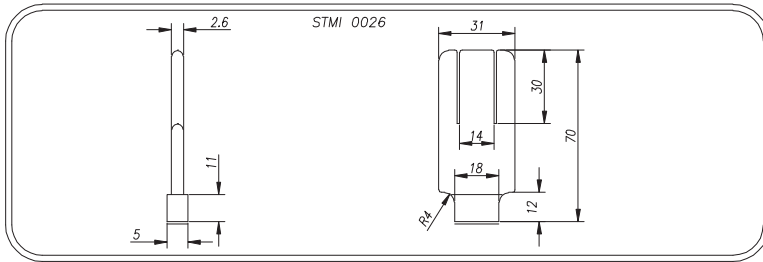

WIDTH = 3mm

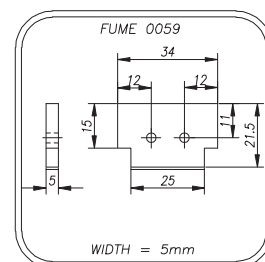
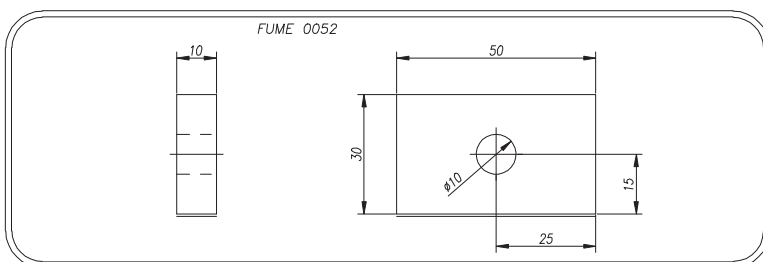

WIDTH = 5mm

CLEATS

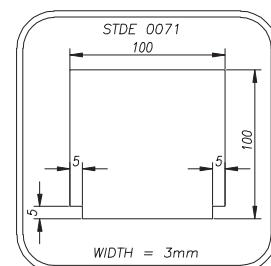
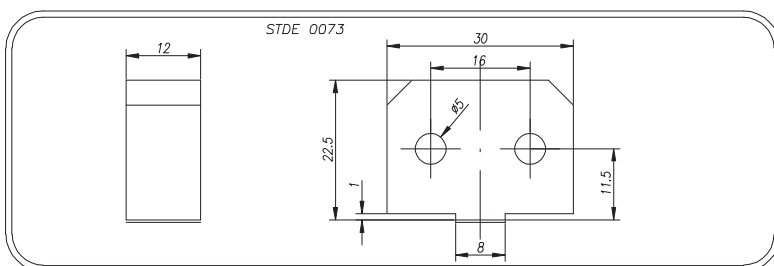
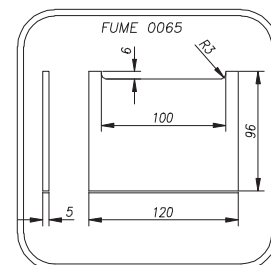
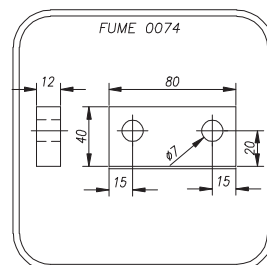
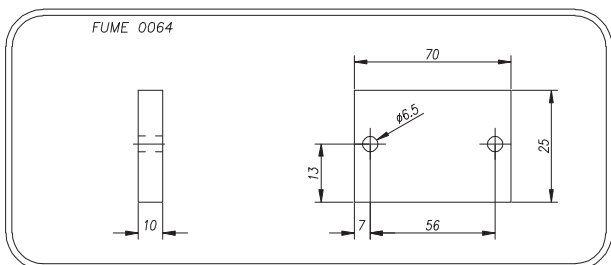
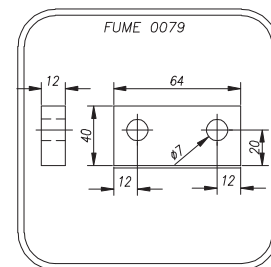
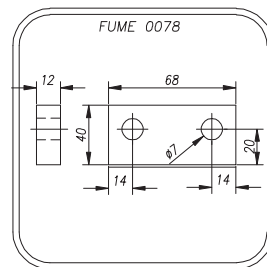
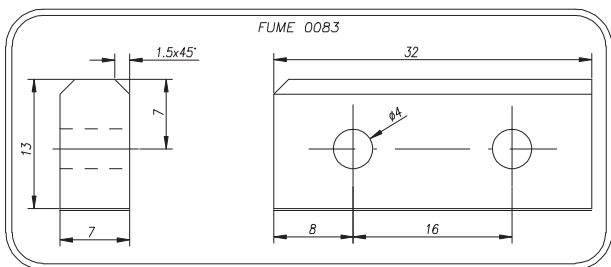
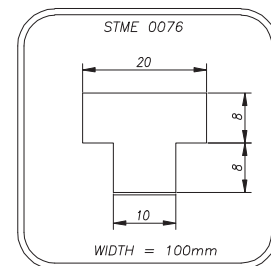
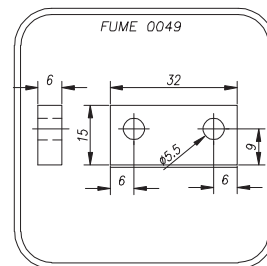
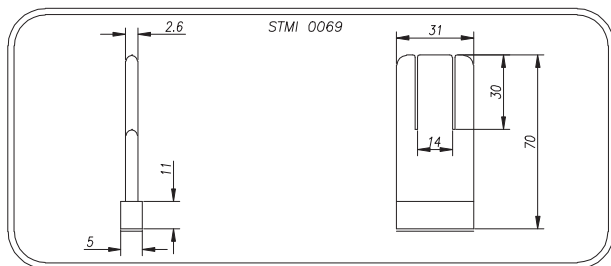
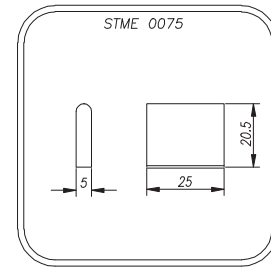
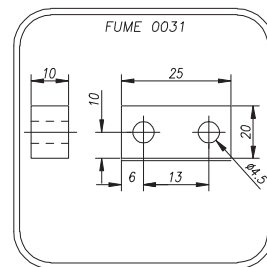
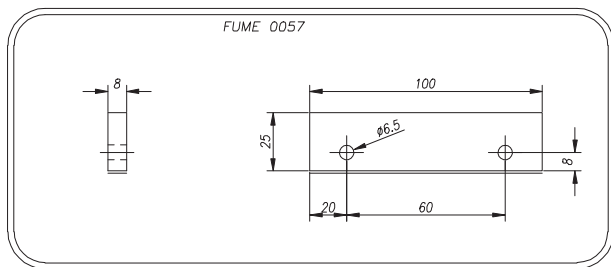
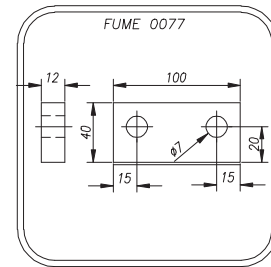
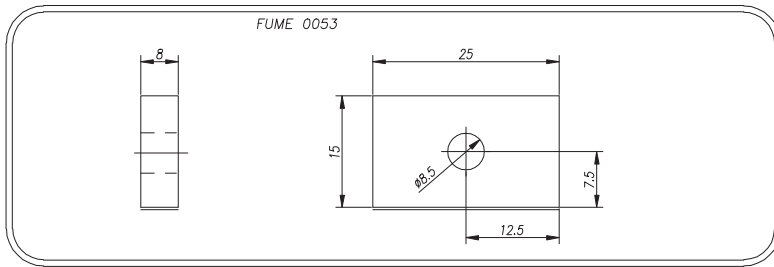

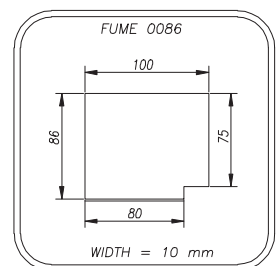
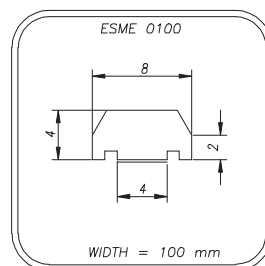
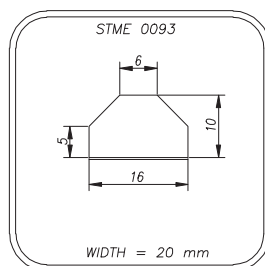
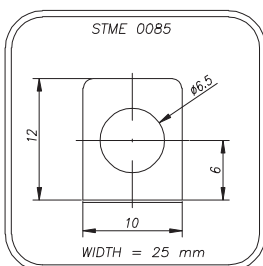
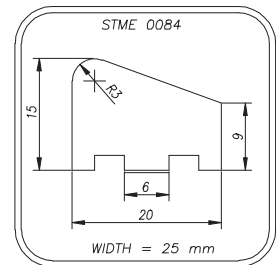
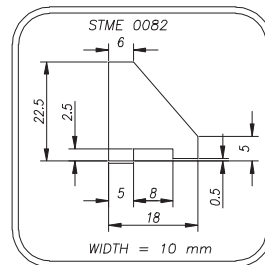
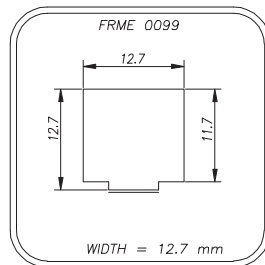
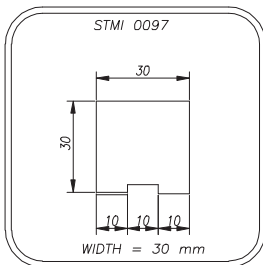
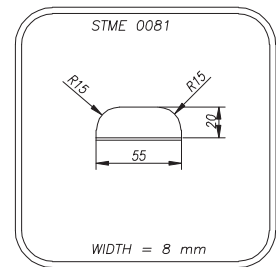
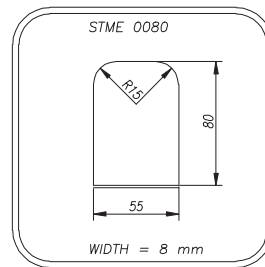
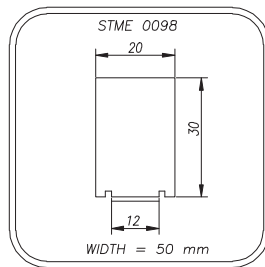
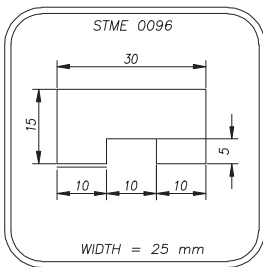
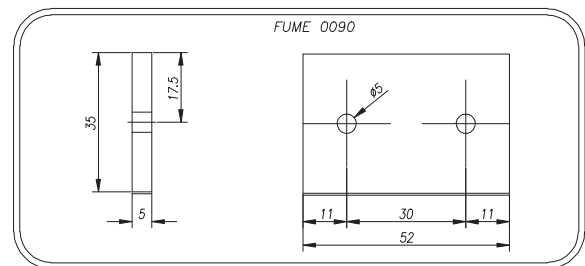
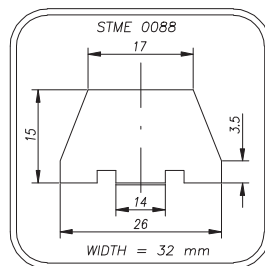
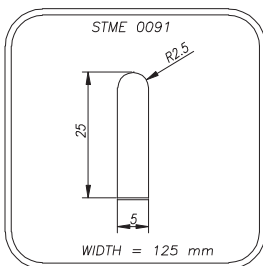
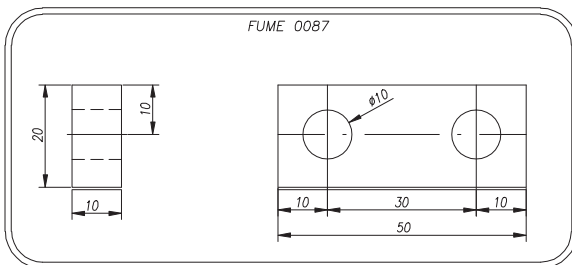
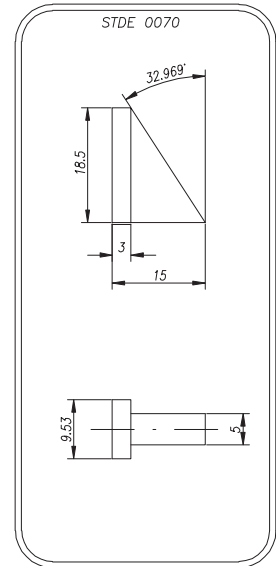
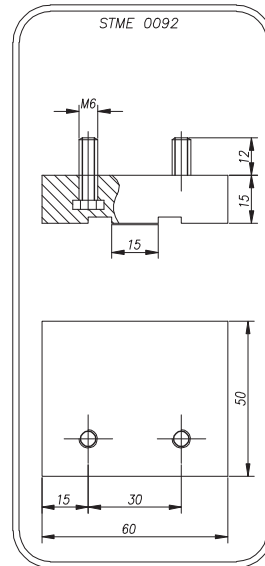
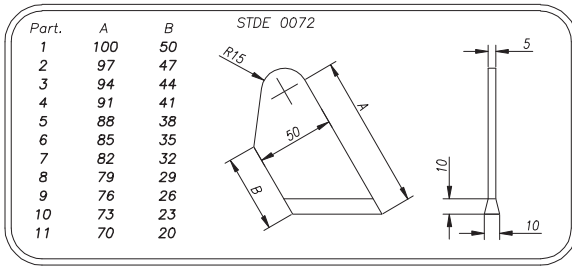

CLEATS

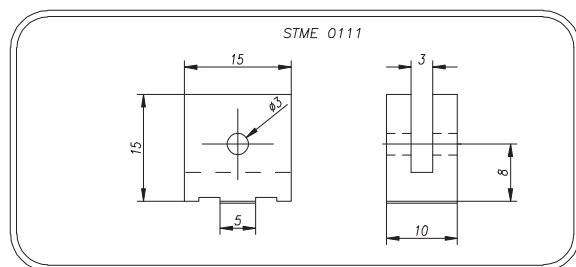
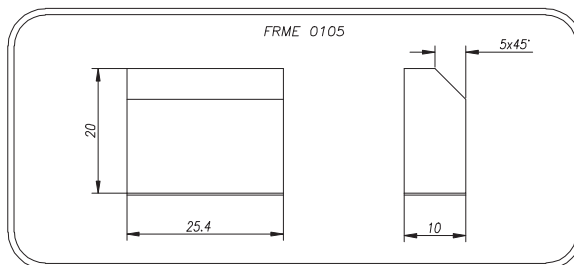
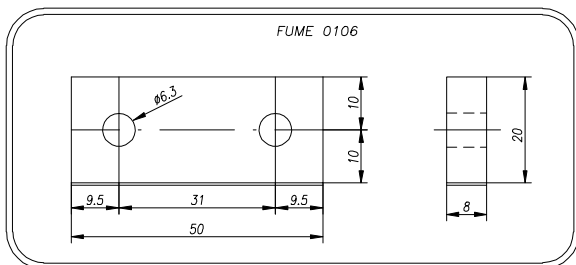
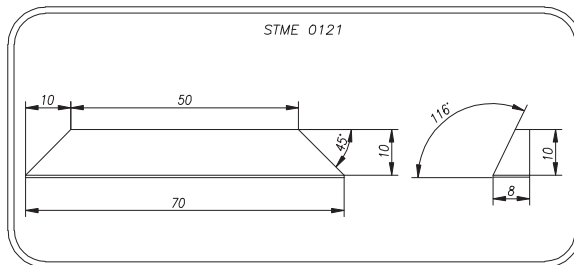
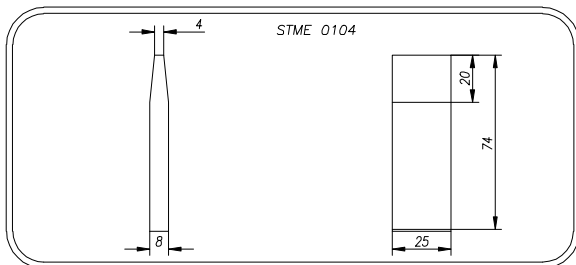
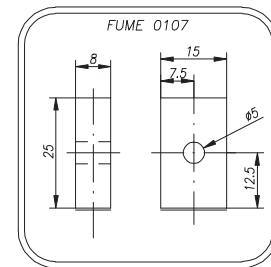
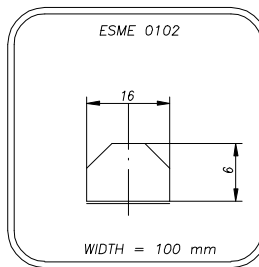
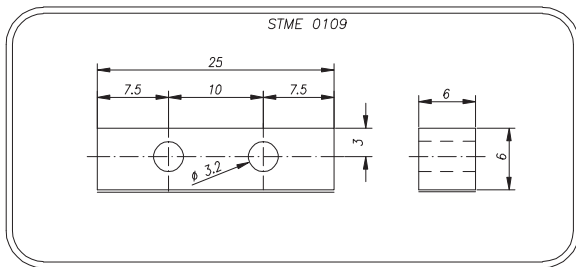
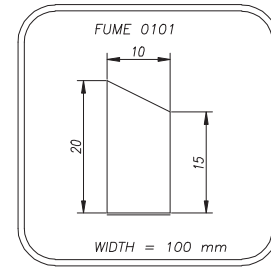
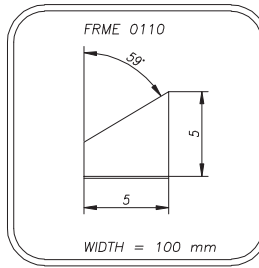
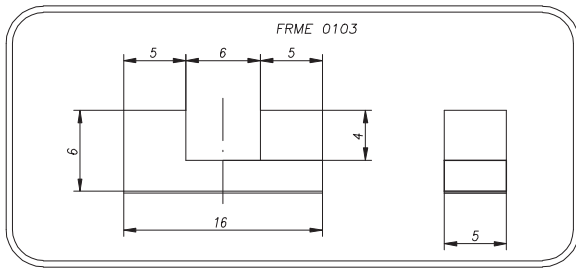
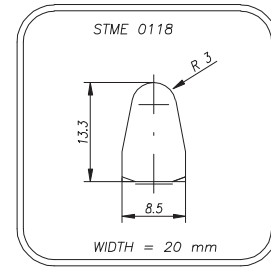
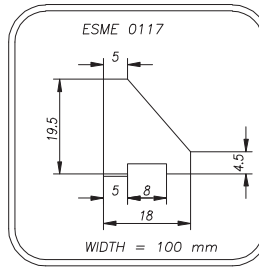
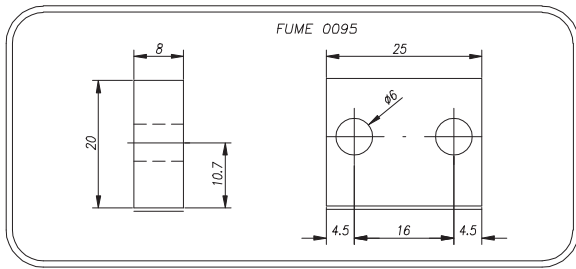

ANTISTATIC POLYURETHANE TIMING BELTS

Megadyne now offers antistatic belts. Under certain conditions, a polyurethane belt may build-up a significant static electric charge. For applications where belts are intended for operation in a potentially explosive atmosphere or near electrical components, polyurethane belts should be sufficiently conductive to dissipate this electrical charge. Belts can be constructed (using proper nylon fabric coating) with a relatively low electrical resistance characteristic and are typically referred to as “static conductive” surface or “antistatic” surface. The test methods for determining the surface resistive properties of a belt are based on ISO 9563, “Belt Drives - Electrical Conductivity of Anti-static Endless Synchronous Belts - Characteristics and Test Method”. To be antistatic the electrical resistance, in ohms, of a belt measured in accordance with test method of norm ISO 9563, should not exceed:

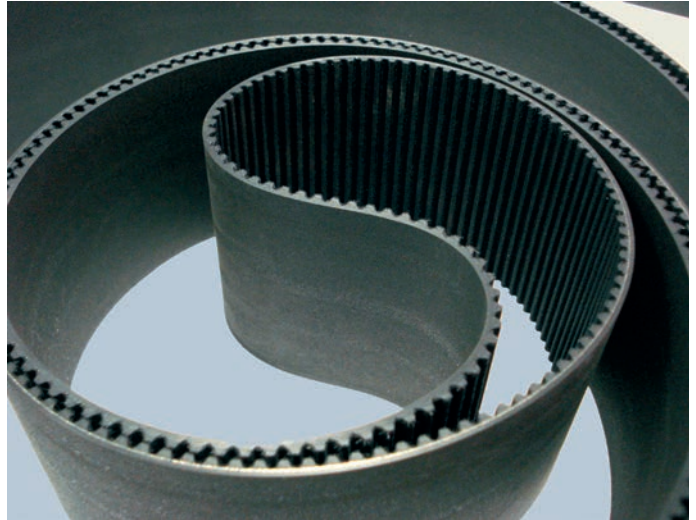

$$\text{Resistance} = \Omega = \frac{(6 \cdot 10^5) \cdot L}{W}$$

where: L = is dry distance between electrodes (7 grooves, 6 teeth between contacts)
W = is the width of the belt

L and W are expressed in the same units (mm or inches).

Megadyne antistatic belts are produced with black polyurethane as standard.

TYPICAL APPLICATIONS

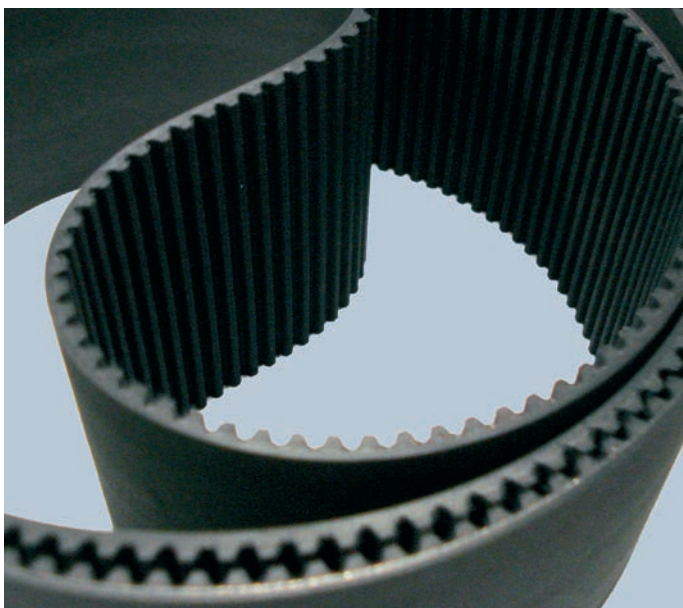

- PC boards or other electronic assemblies industry
- Semiconductor processing
- Paper industry
- Power transmission applications in textile industry
- Chemical environment power transmission
- Clean room power transmissions

COVER PROPERTIES

Megaflex belt can be coated with several materials. Those coatings are able to suit Megaflex belts to all applications. Main advantages for using coated belts are: reducing noise and modifying friction in conveying materials. Choice of correct coating depends on application field.

Megadyne is able to supply extruded coated belt, in this case coating method is same as belt production method and cohesion between belt and cover is guaranteed by welding without using glue.

Properties of extruded coating are followings:

	Cover Type					
	NFT nylon fabric teeth	AVAFC 60	AVAFC 70	AVAFC 85	Foamed polyurethane	Red grip
Raw material	nylon	polyurethane	polyurethane	polyurethane	foamed polyurethane	PU / sintetic rubber
Hardness (ShA)	—	60	70	85	50	50
Colour	green	transparent	transparent	transparent	yellow / grey	red
Coating and belt cohesion method	by extrusion	by extrusion	by extrusion	by extrusion	by spray	by extrusion
Thickness range (mm)	—	2/3/4	2/3/4	2/3/4	0,5 to 8	1 to 8
Tolerance on coating thickness	—	+/- 0,3	+/- 0,3	+/- 0,3	+/- 0,3	+/- 0,3
Working temperature range (°C)	-20 +80	-20 +80	-20 +80	-20 +80	-20 +60	-20 +60
Friction coefficient ⁽¹⁾	0,25	0,65	0,65	0,6	0,4	0,7
Water resistance	good	very good	very good	very good	good	good
Abrasion resistance	intermediate	very good	very good	very good	very good	very good
Oil resistance	intermediate	good	good	good	very good	very good
FDA approved	no	no	no	no	no	no
Min pulley dia = thickness • ... ⁽²⁾	std pulley	x 40	x 40	x 40	x 25	x 30



(1) Static Average values for steel guides.

(2) Suggested diameter is the biggest value between this calculated value and minumun pulley diameter on belt data page.

Megaflex belt can also be supplied with vulcanised or glued cover. Their technical properties are listed in following table:

Cover Type									
Porol mousse	Linatex	Tenax 40	Tenax standard	White Rubber for food industry	Neoprene	Gummy Correx ambra parablond	NBR	Hypalon	Honeycomb
open cell neo-prene rubber	natural rubber	natural rubber	natural rubber	synthetic rubber	synthetic rubber	natural rubber	nitrilic rubber	rubber	natural rubber
10	42	40	45	70	70	48	70	60	45
black	red	red	red	white	grey/black	light brown	white	white	red
by gluing	by gluing	by vulcanisation	by vulcanisation	by vulcanisation	by vulcanisation	by vulcanisation	by vulcanisation	by vulcanisation	by gluing
2 to 15	0,8 to 15	0,8 to 15	0,8 to 15	0,8 to 15	0,8 to 15	0,8 to 15	0,8 to 15	0,8 to 15	4,5 to 15
+/- 0,3	+/- 0,3	+/- 0,3	+/- 0,3	+/- 0,3	+/- 0,3	+/- 0,3	+/- 0,3	+/- 0,3	+/- 0,5
-10 +60	-20 +50	-20 +60	-20 +60	0 +120	-10 +100	-20 +60	0 +120	0 +160	-20 +60
0,7	0,75	0,75	0,7	0,65	0,6	0,6	0,6	0,6	0,6
good	very good	very good	very good	good	very good	very good	good	good	very good
intermediate	very good	very good	very good	intermediate	good	very good	intermediate	intermediate	very good
intermediate	low	low	low	good	good	low	good	good	low
no	no	no	no	no	no	no	no	no	no
x 25	x 30	x 30	x 30	x 35	x 35	x 30	x 35	x 35	x 30

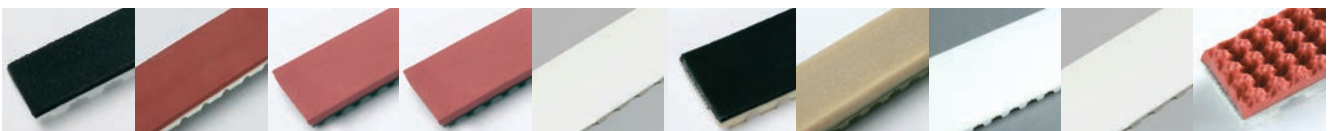

MEGAFLEX FLEASIBILITY TABLE

	XL	L	H	XH	T5	T10	T20	AT5	AT10	AT15	AT20	MTD8	RPP5	RPP8	RPP14	ATG10	P2	
Steel Cords	O	O	O	O	O	O	O	O	O	O	O	O	O	O	O	O	O	O
Kevlar Cords	M	X	M	X	M	M	M	M	M	X	M	M	X	M	X	M	X	
High Performance Cords	X	X	X	X	M	M	M	M	M	X	M	X	X	X	X	X	X	
High Flexibility Cords	M	M	M	M	M	M	M	M	M	X	M	M	M	M	X	M	X	
High Performance Flexibility	X	X	X	X	M	M	M	M	M	X	X	X	X	X	X	X	X	
Stainless Steel Cords	M	M	M	M	M	M	M	M	M	X	M	M	M	M	M	M	M	
High Performance Stainless Steel	X	X	X	X	M	M	M	M	M	X	M	X	X	X	X	X	X	
Fiberglass Cords	X	X	X	X	X	X	X	X	X	X	X	X	X	X	X	X	X	
Polyestere Cords	X	X	X	X	X	X	X	X	X	X	X	X	X	X	X	X	X	
Bifilar Twisting of Cords (S-Z)	M	M	M	M	M	M	M	M	M	M	M	M	M	M	M	M	M	
Nylon Fabric Teeth	M	M	M	M	M	M	M	M	M	M	M	M	O	O	O	M	M	
Nylon Fabric Back	X	X	X	X	X	X	X	X	X	X	X	X	X	X	X	X	X	
Nylon Fabric Teeth Antistatic	M	M	M	M	M	M	M	M	M	M	M	M	M	M	M	X	M	
FDA Compound	X	M	M	M	M	M	M	M	M	X	M	M	X	X	X	M	X	
AvaFc 2 / 4 mm 60° ShA Cover	M	M	M	M	M	M	M	M	M	M	M	M	M	M	M	M	M	
AvaFc 2 / 4 mm 70° ShA Cover	M	M	M	M	M	M	M	M	M	M	M	M	M	M	M	M	M	
AvaFc 2 / 4 mm 85° ShA Cover	M	M	M	M	M	M	M	M	M	M	M	M	M	M	M	M	M	
Pu Yellow Coating 50° ShA	M	M	M	M	M	M	M	M	M	M	M	M	M	M	M	M	M	
APL	X	X	X	X	X	X	X	X	X	X	X	X	X	X	X	X	X	
Fishbone Polyurethane Cover	X	X	X	X	X	X	X	X	X	X	X	X	X	X	X	X	X	
Ribbed Polyurethane Cover	X	X	X	X	X	X	X	X	X	X	X	X	X	X	X	X	X	
Red Grip	M	M	M	M	M	M	M	M	M	M	M	M	M	M	M	M	M	
NP385	X	X	X	X	X	X	X	X	X	X	X	X	X	X	X	X	X	
Supergrip	X	X	X	X	X	X	X	X	X	X	X	X	X	X	X	X	X	
Minigrip	X	X	X	X	X	X	X	X	X	X	X	X	X	X	X	X	X	
Porol Mousse Cover	M	M	M	M	M	M	M	M	M	M	M	M	M	M	M	M	M	
Linatex 42° ShA Cover	M	M	M	M	M	M	M	M	M	M	M	M	M	M	M	M	M	
Tenax 40° / 45° ShA Cover	M	M	M	M	M	M	M	M	M	M	M	M	M	M	M	M	M	
White Alimentary Rubber Cover	M	M	M	M	M	M	M	M	M	M	M	M	M	M	M	M	M	
Neoprene Rubber 70°ShA	M	M	M	M	M	M	M	M	M	M	M	M	M	M	M	M	M	
Gummy Correx Ambra Parablond Cover	M	M	M	M	M	M	M	M	M	M	M	M	M	M	M	M	M	
NBR Cover	M	M	M	M	M	M	M	M	M	M	M	M	M	M	M	M	M	
Hypalon Cover	M	M	M	M	M	M	M	M	M	M	M	M	M	M	M	M	M	
Honey Comb	M	M	M	M	M	M	M	M	M	M	M	M	M	M	M	M	M	
Cleats	M	M	M	M	M	M	M	M	M	M	M	M	M	M	M	M	M	
Double Teeth only for Steel Cords <small>(HF and Stainless Steel Cords whenever feasible, please check with our Staff)</small>	M	M	M	M	M	M	M	M	M	X	M	X	M	M	M	X	X	
Min Length (mm)	1504	1505	1511	1511	1500	1500	1500	1500	1500	1500	1500	1504	-	-	-	1500	1500	
Min Length with NFT (mm)	1905	1905	1905	1911	1900	1900	1900	1900	1900	1905	1900	1904	1900	1904	1904	1900	1900	
Max Length (mm)	22769	22765	22758	22758	22770	22770	22760	22770	22770	22770	22760	22768	22770	22768	22764	22770	22770	
Max Width for Belt (mm)	152,4	152,4	152,4	152,4	150	150	150	150	150	150	150	150	150	150	150	150	150	

O Ex stock
M On request with Minimum Quantity
X Not available

Megadyne can make special extrusion on customer request to improve belt properties and to suit better to special applications.

SPECIAL POLYURETHANE

On customer request and with minimum quantity, Megaflex belt can be produced with different hardness:

- 90ShA food quality polyurethane for contact with food and medical products
- PU blue FCM certified for contact with food
- 92ShA higher resistance to temperature
- 92ShA silicon free for painting system
- 95ShA glass reinforced
- 98ShA extra hard polyurethane

COLOUR

On customer request and with a minimum quantity it is possible to produce Megaflex with several colours. A different colour doesn't influence belt technical properties so mechanical features are the same as standard white belt.

Available colours are: • White • Black • Blue • Yellow • Transparent • Grey

BIFILAR CORDS

On request, all Megaflex range can be manufactured with bifilar twisting cords.

SPECIAL THICKNESS AND BACK GRINDING

All Megaflex belts back is grinded. Sometimes additional grinding may be required to achieve a precise belt thickness as an adjunction to drive's precision. When belt back grinding tolerance is required, the total thickness, including the tooth, must be specified. A grinding tolerance of $\pm 0,2$ mm is achievable with a good level finish (i.e. the thickness will not vary greatly around the belt). On request, it is possible to produce megaflex with extrathickness. Most widths and lengths are available.

LONGITUDINAL REWORK

Longitudinal rework along the belt back is possible on covered and uncovered belts. The profile can be machined precisely for required functions. The measurement is given as the depth in the belt back. Most widths and lengths are available.

REWORK ON BELT TEETH

The rework of the tooth profile can be very useful, i.e. improving the steering effect with guide rails. The rework dimension is given from the top of the tooth. Most belt widths and lengths are available.

HOLES IN BELTS

Holes in timing belts can be for vacuum or air film conveying or as clearance for assembly mechanisms. Stops and cams can be attached through the holes. Customized tooling may be required depending on the layout and dimensions of holes required.

SINGLE TOOTH REMOVAL

Single and multiple tooth removal is available to your requirement, for applications in handling and conveying technology.

SPECIAL EXECUTION PHOTOS

Automotive industry

Transport Skids applications for car industry.

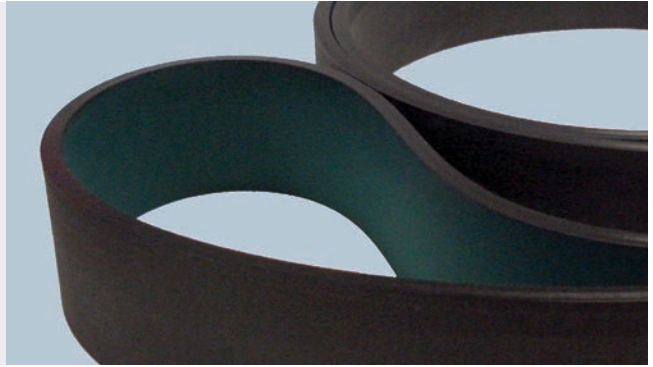

Marble industry

Custom made belt with special back grinding for cutting marble blocks.

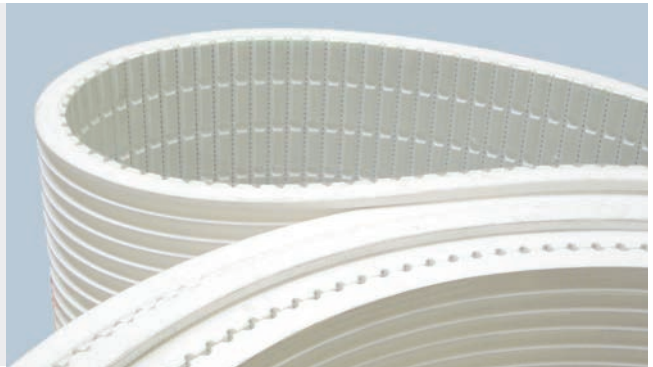

Fitness industry

Self tracking belt for treadmill.



Textile industry

High variety of cleats allow Megaflex to work in several fields.

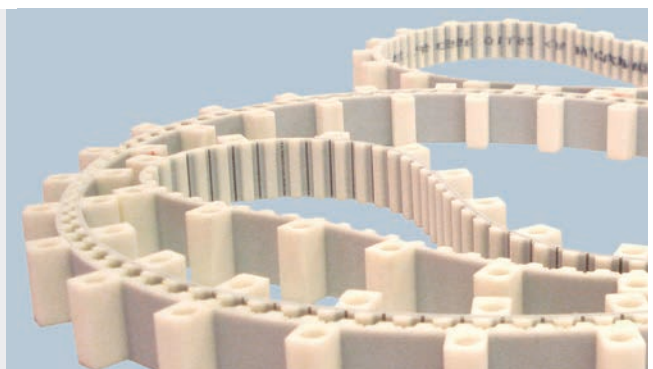

Food industry

High variety of compounds makes Megaflex belt suitable for different application.

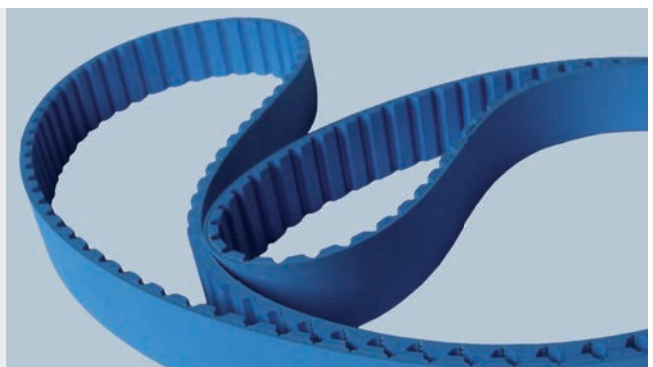

The data and information contained in the present catalogue are up-to-dated to the date of the catalogue's printing. Megadyne Spa reserves the right to modify the specifications, performances and other information relating to the belts described in the present catalogue, at any time at its own discretion, without any prior notice. For updating refer to our web site www.megadynegroup.com.

Technical specifications, performances and other information provided in the present catalogue are indicative and do not bound Megadyne unless such specifications, performances or other information are expressly agreed in the agreement with the customer.

We also recommend to read carefully the following documents in our web site www.megadynegroup.com:

- Megadyne General Conditions of Sale (comprising the warranty)
- Theoretical Belt Life
- Drive Components: Storage, Installation, Maintenance and Troubleshooting Handbook - Belts standard use condition and temperature.

Copyright Notice: Megadyne Spa copyright. All rights reserved. Megadyne is and shall remain the owner of all rights on drawings, technical specifications and any other information contained in the present catalogue or otherwise communicated by Megadyne Spa to the customer. The customer shall not disclose such information to third parties or use such information for purposes different from the definition of the order to Megadyne Spa, unless upon prior written authorization of Megadyne.



MEGADYNE S.p.A.
ITALY - MATHI

BELARUS

Minsk
Kuzme Chornogo 31 -901
220100 Minsk
Phone +375 17 2802486
Info.ee@megadynegroup.com

BRASIL

Sorocaba
Avenida Dr. Armando Pannunzio
610 CEP 18050-000
Sorocaba, São Paulo
Phone +55 15 2101 7700
inquiries@jasonindustrial.com

CANADA

Edmonton
10020 42nd Avenue Edmonton
Alberta T6E 5B4
Phone: +1 780 461 4400
inquiries@jasonindustrial.com

Montreal

9135 Cote De Liesse
Dorval, Quebec H9P 2N9
Phone: +1 514 31 2341
inquiries@jasonindustrial.com

Toronto

927 Matheson Boulevard East
Mississauga, Ontario L4W 2R7
Phone: +1 905 602 4400
inquiries@jasonindustrial.com

CHINA

Beijing
NO.37-344 Fudongyuan.Ciqu Street
Taihu town, Tongzhou
Beijing 101111
Phone +86 10 8150 7478
info.cn@megadynegroup.com

Foshan

n.5 Hedang Industrial Area
East Side Wu Gang Road
Changcheng district, Foshan
Guangdong 528031
Phone +86 757 83815530
info.cn@megadynegroup.com

Fujian

No.720 Marketing Comprehensive
Building, South Lingshui Street
Wuli Industrial Park,
Jinjiang City, Fujian, 362261
Phone +86 595 8816 0309
info.cn@megadynegroup.com

Ningbo

Industrial Chemical Area,
Fengxiang Road 777, Xiepu Town
Zhenghai District,
Ningbo City , Zhejiang Province,
315203
Phone +86 574 8650 2886
info.cn@megadynegroup.com

Qingdao

Longshan town office,
Nange backstreet Jimo city –
Qingdao – Shandong, 266100
Phone +86 532 8765 2117
info.cn@megadynegroup.com

Shanghai

Business Office A area,
6th Floor, 11th Building,
No.1588, Li an Road
Shanghai, 201105
Phone +86 21 5447 1473
info.cn@megadynegroup.com

Shenyang

Room303, Flat 3, No.131-9
Baogong South St.
Tiexi District
Shenyang,110074
Phone +86 24 2572 3238
Fax +86 24 2572 3238
info.cn@megadynegroup.com

COLOMBIA

Cartagena
Diag 22-56-112
Bario el Bosque
Cartagena, Colombia
NIT 900-648-909-6
Phone: 011 57 313 501 5397
inquiries@jasonindustrial.com

CZECH REPUBLIC

Praha
Karlovarska Business Park
Na Hurce 1077/4 (Budova C),
161 00 –
Praha 6 – Ruzyne
Phone +420 2 8481 7181
office.cz@megadynegroup.com

FRANCE

Paris
Logistic Center Zi Les Bordes - 15
Rue Gustave Madiot
91923 Bondoufle Cedex
Phone +33 1 6079 8200
info.fr@megadynegroup.com

St. Jean De Maurienne

le près de la Garde -Av. Italie-
73300 S. Jean de Maurienne
Phone +33 4 7964 0613
info.fr@megadynegroup.com

GERMANY

Borchen
Nikolaus Otto Straße 24
33178 Borchen
Phone +49 5251 8735 0
info.de@megadynegroup.com

Elchingen

Daimlerstraße 13
89275 Elchingen
Phone +49 7308 9665 0
produktion@megadynegroup.com

HUNGARY

Budapest
West Gate Business Park
Topark u. 9
2045 Torokbalint
Phone +36 23 428 628
info.hu@megadynegroup.com

MEXICO

Mexico C.P.
AV. Ceylan 959 Int. 9 Y 10
Industrial Vallejo Azcapotzalco,
Mexico C.P. 02300
Phone +52 55 5587 3680
inquiries@jasonindustrial.com

POLAND

Bydgoszcz
Ofowiana 10, 85-461 Bydgoszcz
POLAND
Phone +48 52 348 77 12
info.pl@megadynegroup.com

SOUTH AFRICA

Johannesburg
Unit 4 - 6, 24 Park Avenue South
- Highway Business Park -
Rooihuiskraal, Centurion
Phone +27 (0)12 661 1652
Fax +27 (0)12 661 1634
info.sa@megadynegroup.com

SPAIN

Barcelona
Ctra de l'Arboc, Km 1,7
08800 Vilanova I La Geltru
Barcelona
Phone +34 93 811 5450
info.sp@megadynegroup.com

SWEDEN

Kristianstad
Estrids Väg 15
291 65 Kristianstad
Phone +46 10 1309600
info.se@megadynegroup.com

THAILAND

Bangkok
S.S.P. Tower – 16th Floor –
Office 10 Soi Sukhumvit 63
(Ekamai) Klong Tan Nuea,
Vadhana Bangkok 10110
Phone: +66 (0) 27115477
info.apac@megadynegroup.com

TURKEY

Izmir
Mustafa Kemal Atatürk Mahallesi
Izmir Ankara Asfalti Caddesi
No:19, 35170 Ulucak Kemalpaşa
Phone +90 232 877 07 00
info@rultrans.com.tr

U.K.

Birmingham
Unit 1, The Washington Centre,
Halesowen Road, Netherton,
Dudley, West Midlands, DY2 9RE
Phone: +44 1384 215 021
sales@megadynegroup.com

U.S.A

California
5660-5680 Rickenbacker Road Bell
Los Angeles, CA 90201
Phone +1 323 265 8061
inquiries@jasonindustrial.com

Florida

5120-B East Adamo Drive Tampa,
FL 33619
Phone +1 813 241 4111
inquiries@jasonindustrial.com

Georgia

Belt Corporation of America
253 Castleberry Industrial Dr.
Cumming, GA 30040
Phone +770 887-9725
inquiries@jasonindustrial.com

Illinois

221 South Westgate Drive
Carol Stream, IL 60188
Phone: +1630 752 0600
inquiries@jasonindustrial.com

New Jersey Americas HQ

340 Kaplan Drive Fairfield
NJ 07004
Phone +1 973 227 4904
inquiries@jasonindustrial.com

North Carolina

11016 Granite Street, Charlotte,
NC 28273
Phone +1 704 583 5388
inquiries@jasonindustrial.com

Oregon

One SE Alder St., Portland,
OR 97214
Phone +1 888 231 7224
inquiries@jasonindustrial.com

South Carolina

101 Pelham Davis Cir, Greenville,
SC 29615-5752
Phone +1 864 288 9916
inquiries@jasonindustrial.com

Texas

8510 Ambassador Row, Dallas
TX 75247
Phone +1 972 438 6992
inquiries@jasonindustrial.com

HEADQUARTERS**ITALY Torino**

Via S. Lucia, 114
10075 Mathi (Torino)
Phone +39 011 926 8052
info@megadynegroup.com

www.megadynegroup.com
www.jasonindustrial.com

