

Link-Belt® Cylindrical Roller Bearings



These bearings require minimum space and provide maximum rated capacity.

Series M1000, 1200, 1300, 1900, 5200, 5300, 7300 Cylindrical Roller Bearings

Metric series cylindrical roller bearings are manufactured to ABMA boundary dimensions. These bearings require minimum space and provide

maximum rated capacity. Various configurations including separable inner or outer ring combinations offer ample application flexibility.



1. Rings of high quality bearing steel for strength, toughness and durability.
2. Microfinished raceways assure smooth operations.
3. Exclusive honed crown on roller profile for optimized raceway contact area and high capacity.
4. Structural design segmented retainer provides high strength, positive roller spacing and guidance.
5. One-piece formed steel retainer provides positive roller spacing and controlled roller guidance.
6. Polymeric retainer of glass fiber reinforced nylon 6/6 provides full roller guidance, superior lubrication and reduced noise.

Segmented Retainers

Rigid structural design segmented steel retainer provides high strength, positive roller spacing and guidance.

All contact surfaces are contoured to minimize the wiping action between retainer segments and rollers, assuring full roller lubrication. Precision spacer segments contact the rollers above and below pitch diameter resulting in low friction loss and positive roller control.



Polymeric Retainers

Made of glass fiber reinforced nylon 6/6, molded polymeric retainers provide close control of roller "drop," low noise, full roller guidance and superior lubrication, at a competitive price.

Extensive testing has established compatibility with a broad range of standard lubricants and satisfactory operation at sustained temperatures to 275°F.



Formed Steel Retainers

One-piece deep coined formed steel retainer combines strength with positive roller spacing and roller guidance.

The retainer guides the rollers below the pitch line and provides control of roller drop. Line contact of rollers on guidance surfaces minimizes wiping action and promotes hydrodynamic lubrication.



Optional Series and Configurations

Series M cylindrical roller bearings are available in seven series with segmented retainers, five series with formed steel retainers, several series with polymeric retainers, and five series of the full roller complement type. Various configurations, including separable inner or outer ring combinations are offered.



Rollers

Exclusively crowned honed rollers provide optimized contact at the raceway. This assures efficient bearing performance under load, provides controlled stress distribution under all loads

within the design capacity and compensates for shaft deflection.

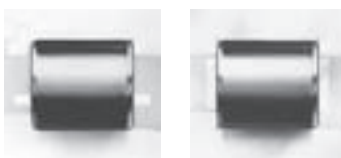

Rings

Rings are manufactured from high quality bearing steel to enhance fatigue resistance, strength, toughness and hardenability.

Bearings and ring and roller assemblies for omitted-ring applications are ABMA standard boundary plan for bore, outside

diameter, and width... standard tolerances are RBEC-1. Precision tolerances to RBEC-5 are available.



Nomenclature		M	A	1	2	05	GEA	X	CO
Symbol	Description								
M	Metric series designation								
A	Plain cylindrical inner ring	} Omitted if inner ring not furnished							
R	Single rib inner ring								
SN	Short, single rib w/inner ring side plate								
U	Double rib inner ring								
S	Metric bore size of next smaller bearing	} Omitted if inner ring not furnished							
None	Standard capacity								
6	High capacity series								
1	Narrow width	}							
5	Wide width								
7	Intermediate width								
0	Extra light series	}							
2	Light series								
3	Medium series								
9	Extra extra light series								
05	One-fifth of bore diameter (mm)								
G	Snap ring groove in outer ring O.D.	} Omitted if outer ring not furnished							
GG	Two snap ring grooves in outer ring O.D.								
R	Snap ring groove in outer ring O.D. snap ring included								
RR	Two snap ring grooves in outer ring O.D.; snap rings included								
C	Plain cylindrical outer ring								
D	Single rib outer ring								
E	Double rib outer ring								
SN	Short single rib w/outer ring side plate								
T	Outer ring w/two retaining rings in I.D.								
U	Single rib outer ring, one retaining ring in I.D.								
A	Oversize O.D. outer ring								
H	Blind dowel hole in outer ring O.D.								
X	Segmented retainer	}							
M	Full complement (no retainer)								
V	Formed steel retainer								
B	Polymeric retainer								
Wxxx	This suffix specifies special bearing features								
None	Standard commercial clearance	}							
C2	Less than basic clearance								
C0	Basic clearance								
C3	Greater than basic clearance								
C4	Greater than C3 clearance								
C5	Greater than standard clearance (STANDARD FOR ASSEMBLY WITH "A" OUTER RING AND OMITTED IN MODEL NUMBER)								
Cxxx	Special specific clearance or range—i.e./C002 or/C35-49 or C3549								

Cylindrical Roller Bearings

To select a bearing, determine the applied radial load, any applied thrust load, the desired Rating Life, and applicable operating conditions. The procedure shown here will aid in selecting a bearing to meet an L10 design life. The formulas for calculating life expectancy should be used to determine the Rating Life L10 for the bearing selected. Cylindrical roller bearings are available in various series with cylindrical bores for direct shaft mounting. Bearings in several series may fulfill the L10 life requirements. Speed limits, minimum shaft diameters, arrangement requirements and space

limitations may be determining factors in final bearing selection. The selection procedures and rating formulas shown here are in agreement with The American Bearing Manufacturers Association Standards and ANSI/ABMA STD 11. Ratings are based on fatigue life. The Rating Life L10 or fatigue life at 90% reliability is the usual basis for bearing selection. Cylindrical roller bearings are essentially radial bearings. Nevertheless those styles where integral ribs are in the proper location on inner and outer rings will also support thrust loading. In fact, most such styles do support incidental,

axial locating loads. Whenever applied thrust loading is known to exist, the guidelines given for Thrust Loads on the next page must be carefully followed. Selection and life expectancy formulas shown here are also valid for inner ring and roller assemblies and for outer ring and roller assemblies provided they are run directly on bearing quality steel shafts or housings properly hardened and ground. To assure a satisfactory bearing application, fitting practice, mounting, lubrication, sealing, static rating, housing strength, operating conditions and maintenance must be considered.

Selection

Step 1

Determine an appropriate L10 design life.

Type of service	Operating time, hours per year	Design life, years	L10 design life, hours
Light seasonal usage	500 to 750	3-5	3,000
Heavy seasonal usage	1,400 to 1,600	4-6	8,000
Industrial—8 hour shift	2,000	10	20,000
Industrial—16 hour shift	4,000	10	40,000
Industrial—continuous	8,700	10	80,000 to 100,000
Continuous—high reliability	—	—	120,000 to 300,000

Step 2

Determine a required $\left(\frac{C}{P}\right)$ from Table 1.

Step 3

Calculate the required C and select a cylindrical roller bearing.

$P = Fr$
 required $C = \left(\frac{C}{P}\right) P$ using $\left(\frac{C}{P}\right)$ from Step 2.

Select a cylindrical roller bearing of the desired type having a basic load rating C equal to or greater than the required C from the appropriate series. The life expectancy of other sizes and series of cylindrical roller bearings can be calculated. When thrust load is present, check the individual bearing thrust capacity and follow the requirements for lubrication under thrust conditions.

Step 4

Determine the permissible speed limit of the bearing through the following procedure:

Permissible speed limits are of practical value only when considered with other factors of bearing operation. Not every application functions satisfactorily at the listed speeds. Load, lubrication, and temperature factors influence the performance. Bearing operation at the listed speed limit demands excellent lubrication, moderate load, and reasonable temperature environment.

Permissible speed can be approximated from the limiting DN value, which is the product of the bearing bore in millimeters and the speed in RPM. The DN values shown below are nominal. For higher permissible speeds, consult Rexnord Bearing Division.

$$DN \text{ value} = \text{Bearing bore (mm)} \times \text{speed (RPM)}$$

Bearing series	Limit of DN Value*
Series 1900, 1000, 1200, 1300 & 7300	
with segmented or polymeric retainer	450,000
with formed steel retainer	250,000
Series 5200, 6200, and 5300	
with segmented or polymeric retainer (5200, 5300 only)	330,000
with formed steel retainer	180,000
Full complement	150,000

*These values assume oil lubrication

Symbols for formulas:

- C = basic load rating, pounds (or newtons)
- Co = static load rating, pounds (or newtons)
- Fr = radial load, pounds (or newtons)
- L10 = rating life, hours
- n = speed, revolutions per minute
- P = equivalent radial load, pounds (or newtons)

Basic Formulas

$$\left(\frac{C}{P}\right) = \left(\frac{L_{10} \times n \times 60}{1,000,000}\right)^{3/10}$$

$$L_{10} = \frac{\left(\frac{C}{P}\right)^{10/3} \times 1,000,000}{n \times 60}$$

Life Expectancy

To calculate the Rating Life L10 of any pair of selected or trial bearings:

Step 1

Determine the equivalent radial load P.

P = Fr

Step 2 Calculate the ratio of the bearing basic load rating C to the equivalent radial load.

$$\frac{C}{P}$$

Step 3

Approximate the bearing life from Table 1.

Thrust Loads

The integral guiding ribs on standard cylindrical roller bearing inner and outer rings will support limited thrust loads. In addition, special tolerances and processing can be used to substantially increase axial load capacity. In either case, excellent lubrication (preferably with an EP lubricant) and a stabilizing radial load are required. For standard bearings, the allowable thrust load is estimated as

$$TM = \frac{C_A}{3n^{0.3}}$$

- where TM Maximum allowable thrust load, pounds (or newtons)
- CA Load rating C (pounds or newtons) of the narrowest series for the given annulus (O.D. and bore) at 33 1/3 RPM and 500L10 hours.
- n Operating speed, RPM

In addition, the thrust load should be no greater than 25% of the radial load. Where application conditions exceed either of these limits, Rexnord Bearing Division should be consulted.

Life Adjustment

The Rating Life, L10, may be modified for some applications in accordance with the formula

$$Ln = a_1 a_2 a_3 L_{10}$$

- where Ln = Adjusted life for (100-n) % reliability,
- a1 = Life adjustment factor for reliability
- a2 = Life adjustment factor for material and processing
- a3 = Life adjustment factor for operating conditions.

For most normal applications, all factors will be taken as 1, and the Rating Life used as the selection basis or life estimate. In addition, as long as standard catalog bearings are used, a2 will be normally set equal to one. The factor a3 covers such things as lubrication, misalignment, and temperature. Some conditions that could yield a3 significantly different than unity include speeds less than 20000 DN or greater than 200000 DN, temperatures below -40°F (-40°C) or above 275°F (135°C), or misalignment greater than 0.0005 radians. For other possible conditions, as well as additional information on life adjustment factors, consult Rexnord Bearing Division.

Table 1 • Relation of L10 life and speed to $\left(\frac{C}{P}\right)$

Bearing life hours L10	Ratio $\left(\frac{C}{P}\right)$								
	Speed, n								
	50	100	200	300	400	500	600	700	800
3000	1.93	2.38	2.93	3.31	3.61	3.86	4.07	4.27	4.44
4000	2.11	2.59	3.19	3.61	3.93	4.20	4.44	4.65	4.84
5000	2.25	2.77	3.42	3.86	4.20	4.50	4.75	4.97	5.18
6000	2.38	2.93	3.61	4.07	4.44	4.75	5.02	5.25	5.47
8000	2.59	3.19	3.93	4.44	4.84	5.18	5.47	5.73	5.96
10000	2.77	3.42	4.20	4.75	5.18	5.54	5.85	6.12	6.37
12000	2.93	3.61	4.44	5.02	5.47	5.85	6.18	6.47	6.73
14000	3.07	3.78	4.65	5.25	5.73	6.12	6.47	6.77	7.05
16000	3.19	3.93	4.84	5.47	5.96	6.37	6.73	7.05	7.34
18000	3.31	4.07	5.02	5.66	6.18	6.60	6.97	7.30	7.60
20000	3.42	4.20	5.18	5.85	6.37	6.81	7.20	7.54	7.85
25000	3.65	4.50	5.54	6.25	6.81	7.29	7.70	8.06	8.39
30000	3.86	4.75	5.85	6.60	7.20	7.70	8.13	8.51	8.86
35000	4.04	4.97	6.12	6.92	7.54	8.06	8.51	8.92	9.28
40000	4.20	5.18	6.37	7.20	7.85	8.39	8.86	9.28	9.66
45000	4.36	5.36	6.60	7.46	8.13	8.69	9.18	9.61	10.00
50000	4.50	5.54	6.81	7.70	8.39	8.97	9.48	9.92	10.30
60000	4.75	5.85	7.20	8.13	8.86	9.48	10.00	10.5	10.90
70000	4.97	6.12	7.54	8.51	9.28	9.92	10.50	11.00	11.40
80000	5.18	6.37	7.85	8.86	9.66	10.30	10.90	11.40	11.90
90000	5.36	6.60	8.13	9.18	10.00	10.70	11.30	11.80	12.30
100000	5.54	6.81	8.39	9.48	10.30	11.00	11.70	12.20	12.70
150000	6.25	7.70	9.48	10.70	11.70	12.50	13.20	13.80	14.40
200000	6.81	8.39	10.30	11.70	12.70	13.60	14.40	15.00	15.70
	Speed, n								
	900	1000	1200	1500	1800	2400	3000	3600	6000
3000	4.60	4.75	5.02	5.36	5.66	6.18	6.60	6.97	8.13
4000	5.02	5.18	5.47	5.85	6.18	6.73	7.20	7.60	8.86
5000	5.36	5.54	5.85	6.25	6.60	7.20	7.70	8.13	9.48
6000	5.66	5.85	6.18	6.60	6.97	7.60	8.13	8.59	10.00
8000	6.18	6.37	6.73	7.20	7.60	8.29	8.86	9.36	10.90
10000	6.60	6.81	7.20	7.70	8.13	8.86	9.48	10.00	11.70
12000	6.97	7.20	7.60	8.13	8.59	9.36	10.00	10.60	12.30
14000	7.30	7.54	7.96	8.51	8.99	9.80	10.50	11.10	12.90
16000	7.60	7.85	8.29	8.86	9.36	10.20	10.90	11.50	13.40
18000	7.88	8.13	8.59	9.18	9.70	10.60	11.30	11.90	13.90
20000	8.13	8.39	8.86	9.48	10.00	10.90	11.70	12.30	14.40
25000	8.69	8.97	9.48	10.10	10.70	11.70	12.50	13.20	15.40
30000	9.18	9.48	10.00	10.70	11.30	12.30	13.20	13.90	16.20
35000	9.61	9.92	10.50	11.20	11.80	12.90	13.80	14.60	17.00
40000	10.00	10.30	10.90	11.70	12.30	13.40	14.40	15.20	17.70
45000	10.40	10.70	11.30	12.10	12.80	13.90	14.90	15.70	18.30
50000	10.70	11.00	11.70	12.50	13.20	14.40	15.40	16.20	18.90
60000	11.30	11.70	12.30	13.20	13.90	15.20	16.20	17.10	20.00
70000	11.80	12.20	12.90	13.80	14.60	15.90	17.00	17.90	20.90
80000	12.30	12.70	13.40	14.40	15.20	16.50	17.70	18.70	21.80
90000	12.80	13.20	13.90	14.90	15.70	17.10	18.30	19.40	22.60
100000	13.20	13.60	14.40	15.40	16.20	17.70	18.90	20.00	23.30
150000	14.90	15.40	16.20	17.30	18.30	20.00	21.40	22.60	26.30
200000	16.20	16.70	17.70	18.90	20.00	21.80	23.30	24.60	28.70

Ratings 25mm, 30mm, 35mm, 40mm Bores

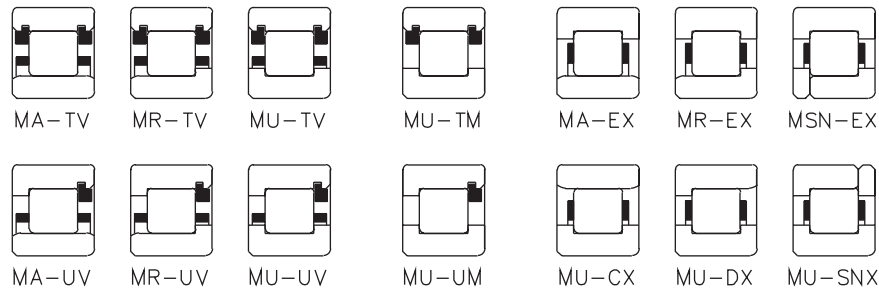

Separable
Non-Separable

Formed Steel Retainer
Full Roller Complement
Segmented Steel Retainer

pounds/newtons

Basic bearing number	Formed steel retainer						Segmented steel retainer			Full roller complement		
	Separable			Non-separable			C Basic load rating	Bearing Capacity 500 RPM, 3000 Hrs. L10	Co Basic static load rating	C Basic load rating	Bearing Capacity 500 RPM, 3000 Hrs. L10	Co Basic static load rating
	C basic load rating	Bearing Capacity 500 RPM, 3000 Hrs. L10	Co Basic Static load rating	C Basic load rating	Bearing Capacity 500 RPM, 3000 Hrs. L10	Co Basic static load rating						
1205	4330	1120	5220	5280	1370	5220	6170	1600	6430	7020	1820	7630
	19200	4980	23200	23500	6080	23200	27500	7110	28600	31200	8090	33900
5205	5930	1540	7830	7240	1880	7830	8460	2190	9640	9620	2490	11400
	26400	6830	34800	32200	8340	34800	37600	9750	42900	42800	11100	50900
1305	6310	1630	6690	7710	2000	6690	8840	2290	8030	9920	2570	9370
	28100	7270	29800	34300	8880	29800	39300	10200	35700	44100	11400	41700
7305	8070	2090	9180	9850	2550	9180	11300	2930	11000	12700	3280	12800
	35900	9300	40800	43800	11400	40800	50200	13000	49000	56400	14600	57100
5305	9720	2520	11700	11900	3070	11700	13600	3530	14000	15300	3960	16300
	43200	11200	51900	52800	13700	51900	60500	15700	62300	68100	17600	72500
1206	5990	1550	7170	7320	1900	7170	8150	2110	8270	9340	2420	9930
	26700	6910	31900	32600	8430	31900	36200	9390	36800	41600	10800	44200
5206	9040	2340	12200	11000	2860	12200	12300	3180	14000	14100	3650	16800
	40200	10400	54100	49100	12700	54100	54700	14200	62500	62700	16200	74900
1306	7970	2060	9270	9730	2520	9270	10300	2680	10000	12100	3130	12400
	35400	9180	41200	43300	11200	41200	45900	11900	44700	53700	13900	55000
7306	10500	2720	13200	12800	3320	13200	13600	3530	14400	15900	4130	17700
	46800	12100	58900	57100	14800	58900	60600	15700	63800	70700	18400	78700
5306	12800	3320	17100	15700	4060	17100	16600	4310	18500	19400	5030	22800
	57000	14800	76100	69600	18000	76100	74000	19200	82400	86400	22400	101000
1207	6840	1770	8030	8350	2160	8030	9290	2410	9270	10700	2760	11100
	30400	7870	35700	37100	9610	35700	41300	10700	41200	47400	12300	49500
5207	11300	2920	15300	13800	3570	15300	15300	3970	17700	17600	4560	21200
	50200	13000	68100	61300	15900	68100	68300	17700	78600	78300	20300	94300
1307	9840	2550	12000	12000	3110	12000	13500	3490	14000	15600	4040	17000
	43800	11300	53400	53400	13800	53400	60000	15500	62400	69400	18000	75700
7307	13800	3580	18700	16900	4380	18700	17900	4630	20100	20700	5350	24400
	61500	15900	83100	75100	19500	83100	79400	20600	89500	91900	23800	109000
5307	15900	4120	22400	19400	5030	22400	20500	5320	24100	23800	6150	29200
	70800	18300	99400	86400	22400	99400	91400	23700	107000	106000	27400	130000
1208	8270	2140	10200	10100	2620	10200	11200	2890	11600	12700	3290	13800
	36800	9530	45300	44900	11600	45300	49700	12900	51800	56500	14600	61500
5208	14300	3710	20700	17500	4530	20700	19400	5010	23600	22000	5700	28000
	63800	16500	91900	77900	20200	91900	86100	22300	105000	97900	25400	125000
1308	12600	3260	15200	15400	3980	15200	16300	4230	16400	19100	4940	20200
	56000	14500	67500	68400	17700	67500	72600	18800	73100	84800	22000	90000
7308	17900	4630	23800	21800	5660	23800	23200	6010	25800	27100	7020	31800
	79600	20600	106000	97200	25200	106000	103000	26700	115000	121000	31200	141000
5308	20000	5190	27600	24500	6330	27600	26000	6720	29900	30300	7860	36800
	89100	23100	123000	109000	28200	123000	115000	29900	133000	135000	35000	163000

Ratings 45mm, 50mm, 55mm Bores

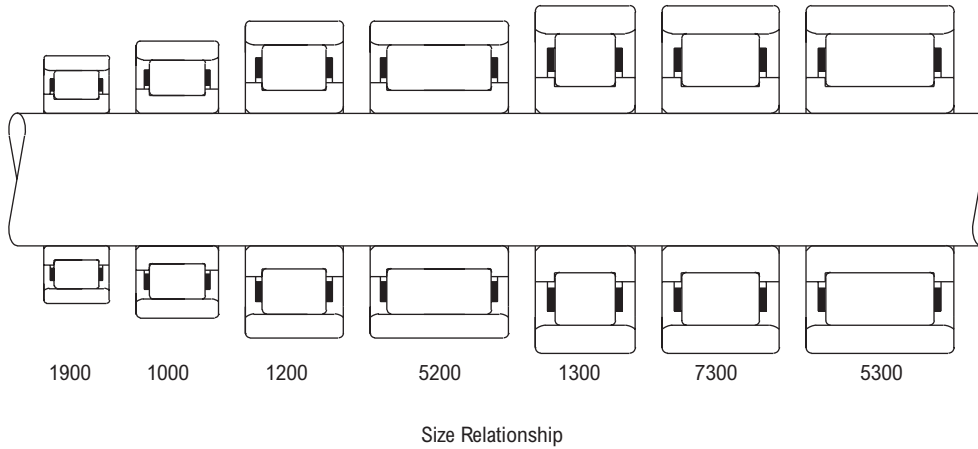

Size Relationship

pounds/newtons												
Basic bearing number	Formed steel retainer						Segmented steel retainer			Full roller complement		
	Separable			Non-separable			C Basic load rating	Bearing Capacity 500 RPM, 3000 Hrs. L10	Co Basic static load rating	C Basic load rating	Bearing Capacity 500 RPM, 3000 Hrs. L10	Co Basic static load rating
	C basic load rating	Bearing Capacity 500 RPM, 3000 Hrs. L10	Co Basic Static load rating	C Basic load rating	Bearing Capacity 500 RPM, 3000 Hrs. L10	Co Basic static load rating						
1209	9670	2500	12900	11800	3060	12900	12900	3340	14500	14500	3750	16900
5209	43000	11100	57300	52500	13600	57300	57400	14900	64500	64400	16700	75200
	15600	4030	23800	19000	4920	23800	20800	5380	26700	23300	6040	31200
1309	69200	17900	106000	84500	21900	106000	92300	23900	119000	104000	26800	139000
	15900	4120	20400	19400	5040	20400	20600	5320	22000	23800	6160	26700
7309	70800	18300	90900	86500	22400	90900	91400	23700	97900	106000	27400	119000
	20300	5260	28000	24800	6430	28000	26200	6790	30100	30300	7860	36600
5309	90400	23400	124000	110000	28600	124000	117000	30200	134000	135000	35000	163000
	24800	6440	36200	30300	7860	36200	32100	8310	39000	37100	9610	47400
1010	111000	28600	161000	135000	35000	161000	143000	37000	174000	165000	42700	211000
	8840	2290	11100
1210	39300	10200	49400
	9830	2550	13600	12000	3110	13600	13000	3380	15200	15100	3900	18400
5210	43700	11300	60600	53400	13800	60600	58000	15000	67700	67000	17300	82000
	15800	4100	25100	19300	5000	25100	21000	5440	28100	24200	6280	34000
1310	70400	18200	112000	85900	22300	112000	93400	24200	125000	108000	27900	151000
	18600	4810	24000	22700	5870	24000	23900	6200	25900	27700	7170	31400
7310	82500	21400	107000	101000	26100	107000	107000	27600	115000	123000	31900	140000
	24000	6220	33500	29300	7590	33500	31000	8030	36000	35900	9290	43800
5310	107000	27700	149000	130000	33800	149000	138000	35700	160000	159000	41300	195000
	29300	7600	43300	35800	9280	43300	37900	9810	46600	43800	11300	56600
1911	131000	33800	193000	159000	41300	193000	169000	43600	207000	195000	50500	252000
	6960	1800	9570
1011	31000	8020	42600
	11200	2890	14300
1211	49800	12900	63400
	11700	3040	16400	1430	3710	16400	15600	4030	18400	18000	4650	22300
5211	52200	13500	73200	63700	16500	73200	69200	17900	81800	79900	20700	99000
	19200	4960	30900	23400	6060	30900	25400	6590	34600	29400	7600	41900
1311	85300	22100	138000	104000	27000	138000	113000	29300	154000	131000	33800	186000
	21900	5680	28800	26800	6930	28800	26800	6930	28800	31000	8020	35000
7311	97500	25300	128000	119000	30800	128000	119000	30800	128000	138000	35700	156000
	29300	7590	41800	35800	9270	41800	35800	9270	41800	41400	10700	50800
5311	130000	33800	186000	159000	41200	186000	159000	41200	186000	184000	47700	226000
	38100	9860	58600	46500	12000	58600	46500	12000	58600	53800	13900	71100
	169000	43900	260000	207000	53500	260000	207000	53500	260000	239000	61900	316000

Ratings 60mm, 65mm, 70mm Bores

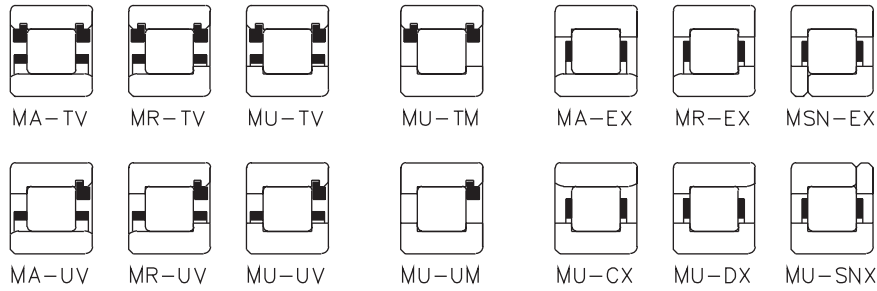

Separable
Non-Separable

Formed Steel Retainer
Full Roller Complement
Segmented Steel Retainer

pounds/newtons

Basic bearing number	Formed steel retainer			Segmented steel retainer			Full roller complement					
	Separable		Non-separable	Bearing		Co Basic static load rating	Bearing		Co Basic static load rating			
	C basic load rating	Bearing Capacity 500 RPM, 3000 Hrs. L10		C Basic load rating	Capacity 500 RPM, 3000 Hrs. L10		C Basic load rating	Capacity 500 RPM, 3000 Hrs. L10				
1912		
1012		
1212	14500	3760	19600	17700	4590	19600	19400	5020	22100	21700	5630	25800
5212	64600	16700	87400	78900	20400	87400	86100	22300	98300	96700	25000	115000
1312	24700	6390	38900	30100	7800	38900	32900	8520	43700	36900	9570	51000
7312	110000	28400	173000	134000	34700	173000	146000	37900	194000	164000	42600	227000
5312	24900	6450	32800	30400	7880	32800	32100	8330	35300	37200	9630	42900
	111000	28700	146000	135000	35500	146000	143000	37000	157000	165000	42800	191000
	32600	8450	46400	39800	10300	46400	42100	10900	50000	48700	12600	60700
	145000	37600	206000	177000	45900	206000	187000	48500	222000	217000	56100	270000
	43900	11400	68000	53600	13900	68000	56600	14700	73200	65500	17000	88900
	195000	50500	302000	238000	61700	302000	252000	65200	326000	291000	75500	395000
1913
1013
1213	16800	4360	24400	20500	5320	24400	21400	5540	25800	24700	6390	31200
5213	74800	19400	109000	91400	23700	109000	95100	24600	115000	110000	28400	139000
1313	26800	6930	44400	32700	8460	44400	34000	8810	46800	39300	10200	56700
7313	119000	30800	197000	145000	37600	197000	151000	39200	208000	175000	45200	252000
5313	30800	7970	41900	37600	9730	41900	37600	9730	41900	43400	11300	50900
	137000	35400	186000	167000	43300	186000	167000	43300	186000	193000	50100	226000
	39200	10100	57200	47800	12400	57200	47800	12400	57200	55300	14300	69400
	174000	45100	254000	213000	55100	254000	213000	55100	254000	246000	63700	309000
	54900	14200	88200	67000	17300	88200	67000	17300	88200	77500	20100	107000
	244000	63200	392000	298000	77200	392000	298000	77200	392000	345000	89300	476000
1914
1014
1214	18100	4700	26300	22100	5730	26300	24100	6230	29400	27900	7190	35600
5214	80600	20900	117000	98500	25500	117000	107000	27700	131000	124000	32000	158000
1314	29900	7750	50100	36600	9470	50100	39700	10300	56000	45900	11900	67800
7314	133000	34500	223000	163000	42100	223000	177000	45800	249000	204000	52800	302000
5314	35300	9130	48800	43000	11100	48800	43000	11100	48800	49800	12900	59200
	157000	40600	217000	191000	49600	217000	191000	49600	217000	221000	57400	263000
	43800	11300	64400	53500	13800	64400	53500	13800	64400	61800	16000	78200
	195000	50400	287000	238000	61600	287000	238000	61600	287000	275000	71300	348000
	57600	14900	91700	70400	18200	91700	70400	18200	91700	81400	21100	111000
	256000	66400	408000	313000	81100	408000	313000	81100	408000	362000	93800	495000

Ratings 75mm, 80mm, 85mm Bores

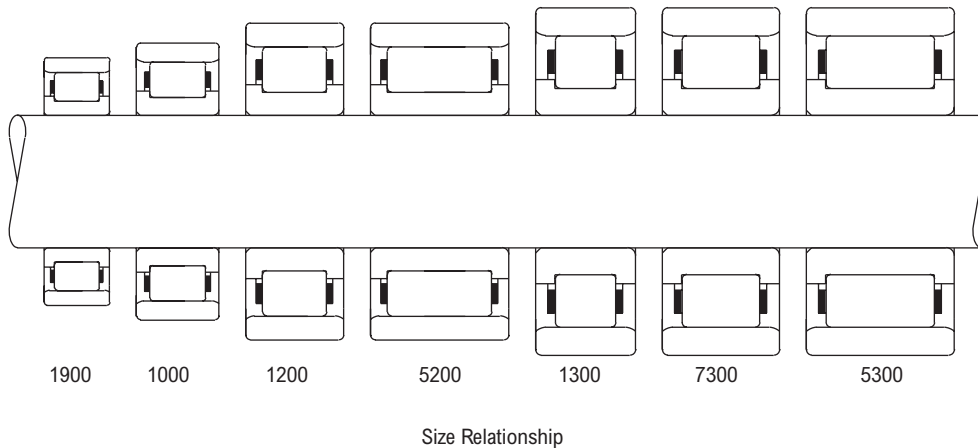

pounds/newtons												
Basic bearing number	Formed steel retainer						Segmented steel retainer			Full roller complement		
	Separable			Non-separable			C Basic load rating	Bearing Capacity 500 RPM, 3000 Hrs. L10	Co Basic static load rating	C Basic load rating	Bearing Capacity 500 RPM, 3000 Hrs. L10	Co Basic static load rating
	C basic load rating	Bearing Capacity 500 RPM, 3000 Hrs. L10	Co Basic Static load rating	C Basic load rating	Bearing Capacity 500 RPM, 3000 Hrs. L10	Co Basic static load rating						
1915	11200	2910	16900
1015	50000	13000	75200
1215	18800	4880	28000	23000	5960	28000	15300	3970	20300
5215	32500	8430	56600	39700	10300	56600	68200	17700	90300
1315	145000	37500	252000	177000	45800	252000	24900	6450	31100	28600	7390	37400
7315	83800	21700	125000	102000	26500	125000	43000	11100	62900	157000	32900	166000
5315	216000	55900	318000	264000	68300	318000	191000	49500	280000	49300	12800	75500
	315000	81700	518000	385000	99800	518000	199000	51400	221000	219000	56800	336000
	163000	42100	221000	199000	51400	221000	44600	11600	49700	51600	13400	60300
	163000	42100	221000	199000	51400	221000	199000	51400	221000	230000	59500	268000
	48500	12600	71500	59300	15400	71500	59300	15400	71500	68600	17800	86900
	216000	55900	318000	264000	68300	318000	264000	68300	318000	305000	79000	386000
	70900	18400	116000	86600	22400	116000	86600	22400	116000	100000	25900	141000
	315000	81700	518000	385000	99800	518000	385000	99800	518000	446000	115000	629000
1916	11600	3010	18000
1016	51700	13400	80000
1216	20600	5330	30100	25100	6500	30100	19200	4970	25800
5216	91500	23700	134000	112000	28900	134000	85300	22100	115000
1316	164000	42400	283000	200000	51800	283000	27200	7040	33400	30200	7820	38400
7316	185000	47900	255000	226000	58400	255000	121000	31300	149000	134000	34800	171000
5316	245000	63500	367000	299000	77500	367000	48700	12600	70700	54000	14000	81300
	326000	84400	528000	398000	103000	528000	216000	56100	315000	240000	62300	362000
	41500	10800	57300	50700	13100	57300	50700	13100	57300	58700	15200	69600
	185000	47900	255000	226000	58400	255000	226000	58400	255000	261000	67600	309000
	55100	14300	82400	67300	17400	82400	67300	17400	82400	77900	20200	100000
	245000	63500	367000	299000	77500	367000	299000	77500	367000	346000	89700	445000
	73300	19000	119000	89400	23200	119000	89400	23200	119000	103000	26800	144000
	326000	84400	528000	398000	103000	528000	398000	103000	528000	460000	119000	642000
1917	13700	3550	20900
1017	60900	15800	93100
1217	24800	6410	36700	30200	7830	36700	19700	5100	27000
5217	110000	28500	163000	134000	34800	163000	87500	22700	120000
1317	45300	11700	79700	55300	14300	79700	31500	8160	38700	36300	9410	46900
7317	201000	52200	354000	246000	63700	354000	140000	36300	172000	162000	41900	208000
5317	44600	11500	61200	54400	14100	61200	57600	14900	84100	66400	17200	102000
	198000	51300	272000	242000	62700	272000	356000	66300	374000	296000	76500	453000
	61700	16000	92900	75400	19500	92900	54400	14100	61200	63000	16300	74300
	275000	71100	413000	335000	86800	413000	242000	62700	272000	280000	72500	330000
	86300	22400	143000	105000	27300	143000	75400	19500	92900	87200	22600	113000
	384000	99500	636000	469000	121000	636000	335000	86900	413000	388000	100000	502000
	384000	99500	636000	469000	121000	636000	105000	27300	143000	122000	31600	174000
	384000	99500	636000	469000	121000	636000	469000	121000	636000	542000	140000	773000

Ratings 90mm, 95mm, 100mm Bores

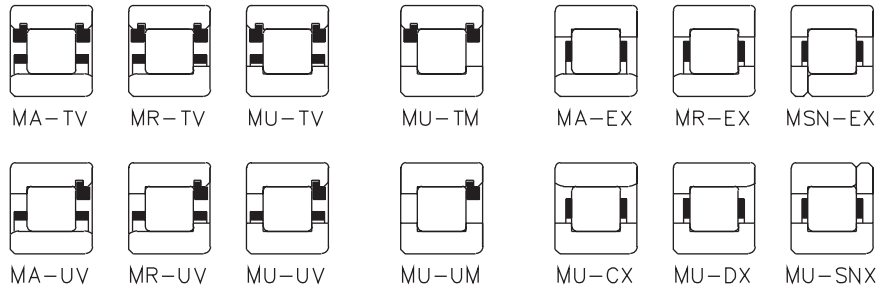

Separable
Non-Separable

Formed Steel Retainer
Full Roller Complement
Segmented Steel Retainer

pounds/newtons

Basic bearing number	Formed steel retainer						Segmented steel retainer			Full roller complement		
	Separable			Non-separable			C Basic load rating	Bearing Capacity 500 RPM, 3000 Hrs. L10	Co Basic static load rating	C Basic load rating	Bearing Capacity 500 RPM, 3000 Hrs. L10	Co Basic static load rating
	C basic load rating	Bearing Capacity 500 RPM, 3000 Hrs. L10	Co Basic Static load rating	C Basic load rating	Bearing Capacity 500 RPM, 3000 Hrs. L10	Co Basic static load rating						
1918	14200	3670	22200
1018	6300	16300	98900
1218	28700	7440	42600	35100	9090	42600	24900	6440	33500
5218	128000	33100	190000	156000	40400	190000	111000	28600	149000
1318	51000	13200	89100	62300	16100	89100	38100	9880	47600	42600	11000	55100
7318	227000	58700	396000	277000	71700	396000	170000	43900	212000	189000	49000	245000
5318	52600	13600	74200	64200	16600	74200	67700	17500	99600	75500	19600	115000
	234000	60600	330000	285000	73900	330000	301000	78000	443000	336000	87000	513000
	69000	17900	105000	84300	21800	105000	64200	16600	74200	74200	19200	90100
	307000	79500	469000	375000	97100	469000	285000	73900	330000	330000	85500	401000
	88400	22900	145000	108000	27900	145000	84300	21800	105000	97500	25300	128000
	393000	102000	644000	480000	124000	644000	375000	97100	469000	434000	112000	569000
							108000	27900	145000	125000	32300	176000
							480000	124000	644000	556000	144000	783000
1919	14600	3790	23600
1019	65100	16900	105000
1219	33400	8650	50000	40800	10600	50000	25500	6600	35100
5219	149000	38500	222000	181000	47000	222000	113000	29400	156000
1319	58500	15200	103000	71400	18500	103000	42600	11000	53000	49500	12800	64700
7319	260000	67400	457000	318000	82300	457000	42600	11000	53000	220000	57000	288000
5319	55300	14300	80500	67600	17500	80500	189000	49000	236000	86700	22400	133000
	246000	63700	358000	300000	77800	358000	74600	19300	109000	386000	99800	592000
	75800	19600	121000	92600	24000	121000	332000	85900	484000	386000	99800	592000
	337000	87400	537000	412000	107000	537000	67600	17500	80500	77400	20100	96600
	93000	24100	157000	114000	29400	157000	300000	77800	358000	344000	89200	430000
	414000	107000	698000	505000	131000	698000	92600	24000	121000	106000	27500	145000
							412000	107000	537000	472000	122000	644000
							114000	29400	157000	130000	33700	188000
							505000	131000	698000	579000	150000	838000
1920	17300	4470	25600
1020	76800	19900	114000
1220	36500	9470	54800	44600	11600	54800	26100	6760	36700
5220	163000	42100	244000	198000	51400	244000	116000	30100	163000
1320	65900	17100	117000	80500	20800	117000	46600	12100	58000	54100	14000	70900
7320	293000	76000	520000	358000	92700	520000	207000	53700	258000	241000	62400	315000
5320	60600	15700	88300	74000	19200	88300	84000	21800	124000	97700	25300	151000
	270000	69800	393000	329000	85300	393000	374000	96800	551000	434000	113000	674000
	82500	21400	131000	101000	26100	131000	74000	19200	88300	84800	22000	106000
	367000	95000	584000	448000	116000	584000	329000	85300	393000	377000	97700	472000
	111000	28700	192000	135000	35100	192000	101000	26100	131000	115000	29900	157000
	493000	128000	855000	602000	156000	855000	448000	116000	584000	513000	133000	700000
							135000	35100	192000	155000	40200	231000
							602000	156000	855000	691000	179000	1030000

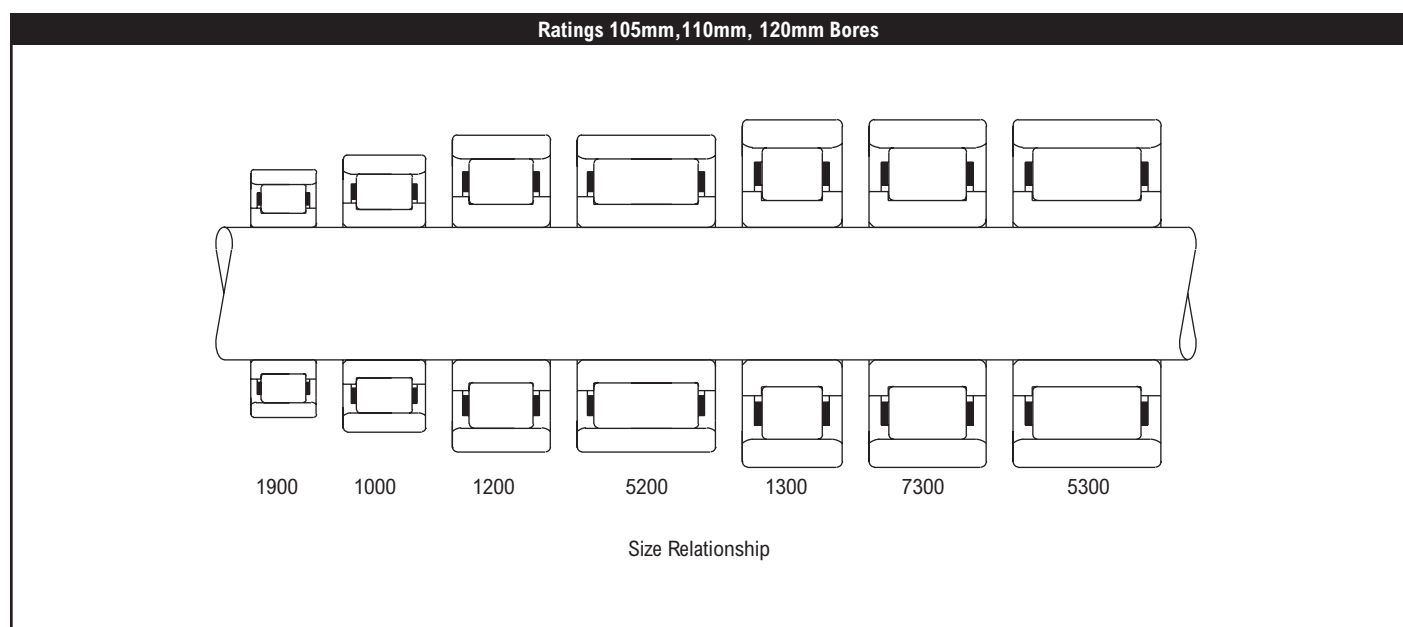

pounds/newtons												
Basic bearing number	Formed steel retainer						Segmented steel retainer			Full roller complement		
	Separable			Non-separable			C Basic load rating	Bearing Capacity 500 RPM, 3000 Hrs. L10	Co Basic static load rating	C Basic load rating	Bearing Capacity 500 RPM, 3000 Hrs. L10	Co Basic static load rating
	C basic load rating	Bearing Capacity 500 RPM, 3000 Hrs. L10	Co Basic Static load rating	C Basic load rating	Bearing Capacity 500 RPM, 3000 Hrs. L10	Co Basic static load rating						
1921	17900	4650	27300
1021	79800	20700	121000
1221	38600	9990	57800	47100	12200	57800	31000	8040	45000
5221	73400	19000	132000	89600	23200	132000	138000	35800	200000
1321	71700	18600	108000	87500	22700	108000	49200	12700	61200	57200	14800	74800
7321	319000	82500	479000	389000	101000	479000	219000	56600	272000	254000	65800	333000
5321	90500	23400	145000	110000	28600	145000	93600	24200	140000	109000	28200	171000
	403000	104000	647000	491000	127000	647000	416000	108000	622000	484000	125000	760000
	118000	30500	204000	144000	37200	204000	87500	22700	108000	100000	26000	129000
	523000	136000	906000	639000	165000	906000	389000	101000	479000	446000	116000	575000
1922	491000	127000	647000	563000	146000	776000
1022	118000	30500	204000	165000	42700	244000
1222	43600	11300	67300	53200	13800	67300	639000	165000	906000	734000	190000	1090000
5222	194000	50200	299000	237000	61300	299000	18200	4720	28200
1322	79900	20700	147000	97600	25300	147000	81200	21000	125000
7322	356000	92100	653000	434000	112000	653000	35300	9150	50600
5322	72800	18900	107000	88900	23000	107000	157000	40700	225000
	324000	83800	477000	395000	102000	477000	55400	14400	71100	61900	16000	82300
	99800	25800	161000	122000	31500	161000	247000	63900	316000	275000	71300	366000
	444000	115000	715000	542000	140000	715000	102000	26300	155000	113000	29400	179000
	138000	35700	244000	169000	43600	244000	452000	117000	689000	505000	131000	798000
	614000	159000	1090000	750000	194000	1090000	88900	23000	107000	102000	26400	129000
1924	395000	102000	477000	453000	117000	572000
1024	122000	31500	161000	140000	36200	193000
1224	49400	12800	77900	60300	15600	77900	122000	31500	161000	140000	36200	193000
5224	220000	56900	347000	268000	69500	347000	542000	140000	715000	621000	161000	858000
1324	97200	25200	186000	119000	30700	186000	169000	43600	244000	193000	50000	293000
7324	432000	112000	827000	528000	137000	827000	750000	194000	1090000	859000	223000	1300000
5324	84600	21900	126000	103000	26700	126000	23800	6160	37300
	376000	97400	562000	459000	119000	562000	106000	27400	166000
	118000	30500	193000	144000	37300	193000	37000	9590	55100
	524000	136000	861000	640000	166000	861000	165000	42700	245000
	170000	44100	310000	208000	53900	310000	62800	16300	82300	72500	18800	99600
	757000	196000	1380000	925000	240000	1380000	279000	72400	366000	323000	83500	443000
							124000	32000	196000	143000	36900	238000
							550000	142000	873000	634000	164000	1060000
							103000	26700	126000	118000	30700	151000
							459000	119000	562000	527000	136000	674000
							144000	37300	193000	165000	42700	232000
							640000	166000	861000	734000	190000	1030000
							208000	53900	310000	238000	61700	373000
							925000	240000	1380000	1060000	275000	1660000

Ratings 130mm, 140mm, 150mm Bores

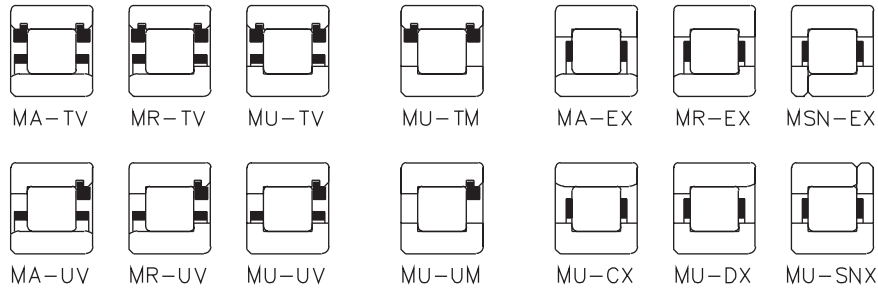

Separable
Non-Separable

Formed Steel Retainer
Full Roller Complement
Segmented Steel Retainer

pounds/newtons

Basic bearing number	Formed steel retainer			Segmented steel retainer			Full roller complement					
	Separable			Non-separable			C Basic load rating	Bearing Capacity 500 RPM, 3000 Hrs. L ₁₀	Co Basic static load rating	C Basic load rating	Bearing Capacity 500 RPM, 3000 Hrs. L ₁₀	Co Basic static load rating
	C basic load rating	Bearing Capacity 500 RPM, 3000 Hrs. L ₁₀	Co Basic Static load rating	C Basic load rating	Bearing Capacity 500 RPM, 3000 Hrs. L ₁₀	Co Basic static load rating						
1926	30100	7800	47600
1026	134000	34700	212000
1226	55300	14300	85200	67500	17500	85200	47500	12300	69100
5226	246000	63700	379000	300000	77800	379000	211000	54700	307000
1326	104000	26900	192000	127000	32800	192000	67500	17500	85200	78500	20300	104000
7326	462000	120000	852000	564000	146000	852000	300000	77800	379000	349000	90400	463000
5326	100000	25900	151000	122000	31700	151000	127000	32800	192000	147000	38200	234000
	446000	115000	674000	544000	141000	674000	564000	146000	852000	655000	170000	1040000
	138000	35700	228000	168000	43600	228000	122000	31700	151000	140000	36300	182000
	613000	159000	1020000	749000	194000	1020000	544000	141000	674000	624000	162000	808000
	190000	49300	346000	232000	60200	346000	168000	43600	228000	193000	50000	274000
	847000	219000	1540000	1030000	268000	1540000	749000	194000	1020000	858000	222000	1220000
							232000	60200	346000	267000	69000	415000
							1030000	268000	1540000	1190000	307000	1850000
1928	31100	8060	50800
1028	138000	35900	226000
1228	61700	16000	95000	75300	19500	95000	49900	12900	75100
5228	274000	71100	422000	335000	86800	422000	222000	57400	334000
1328	129000	33400	244000	157000	40700	244000	75300	19500	95000	87600	22700	116000
7328	573000	148000	1090000	699000	181000	1090000	335000	86800	422000	390000	101000	516000
5328	111000	28800	170000	136000	35200	170000	157000	40700	244000	183000	47300	299000
	495000	128000	756000	605000	157000	756000	699000	181000	1090000	813000	211000	1330000
	158000	40800	266000	192000	49800	266000	136000	35200	170000	156000	40400	204000
	701000	182000	1180000	856000	222000	1180000	605000	157000	756000	693000	180000	907000
	209000	54200	383000	256000	66200	383000	192000	49800	266000	221000	57100	319000
	931000	241000	1700000	1140000	295000	1700000	856000	222000	1180000	981000	254000	1420000
							256000	66200	383000	293000	75900	460000
							1140000	295000	1700000	1300000	338000	2050000
1930	41800	10800	68600
1030	186000	48100	305000
1230	71000	18400	111000	86700	22500	111000	56700	14700	85800
5230	316000	81800	492000	386000	99900	492000	252000	65300	382000
	150000	38900	289000	183000	47500	289000	86700	22500	111000	101000	26100	135000
	668000	173000	1290000	815000	211000	1290000	386000	99900	492000	448000	116000	601000
							183000	47500	289000	213000	55200	354000
							815000	211000	1290000	948000	245000	1570000

Ratings 160mm, 170mm, 180mm, 190mm, 200mm Bores

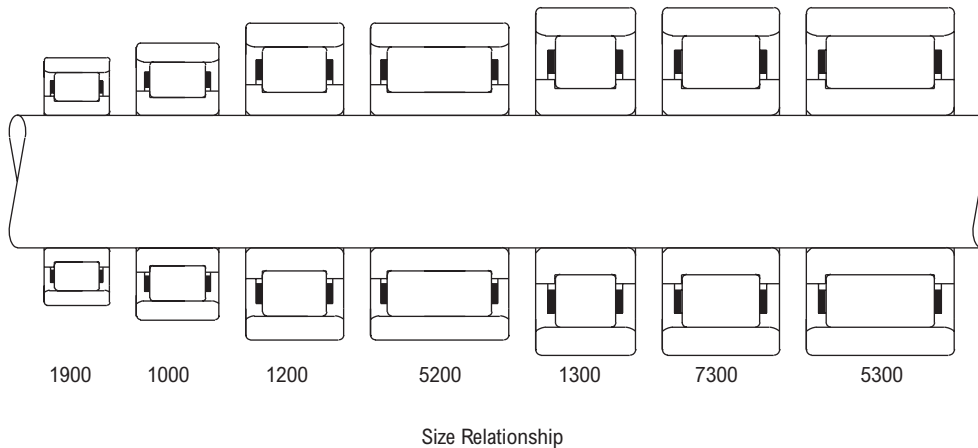

Size Relationship

Basic bearing number	pounds/newtons											
	Formed steel retainer						Segmented steel retainer			Full roller complement		
	Separable			Non-separable			C Basic load rating	Bearing Capacity 500 RPM, 3000 Hrs. L10	Co Basic static load rating	C Basic load rating	Bearing Capacity 500 RPM, 3000 Hrs. L10	Co Basic static load rating
	C basic load rating	Bearing Capacity 500 RPM, 3000 Hrs. L10	Co Basic Static load rating	C Basic load rating	Bearing Capacity 500 RPM, 3000 Hrs. L10	Co Basic static load rating						
1932	43200	11200	73100
1032	192000	49800	325000
1232	78300	20300	120000	95600	24800	120000	289000	74800	444000	112000	29000	148000
5232	348000	90200	534000	425000	110000	534000	99800	25800	127000	498000	129000	660000
	174000	45100	336000	213000	55100	336000	222000	57500	356000	249000	64600	415000
	775000	201000	1490000	946000	245000	1490000	988000	256000	1580000	1110000	287000	1850000
1934	43700	11300	75500
1034	195000	50400	336000
1234	95700	24800	149000	117000	30300	149000	81400	21100	130000	137000	35500	184000
5234	426000	110000	664000	520000	135000	664000	362000	93800	577000	609000	158000	820000
	202000	52400	391000	247000	64000	391000	122000	31600	158000	290000	75000	483000
	900000	233000	1740000	1100000	285000	1740000	543000	141000	703000	1290000	334000	2150000
1936	56000	14500	93700
1036	249000	64500	417000
1236	99600	25800	159000	122000	31500	159000	97900	25400	154000	136000	35300	186000
5236	443000	115000	708000	541000	140000	708000	436000	113000	685000	607000	157000	826000
	195000	50600	379000	239000	61800	379000	541000	140000	708000	268000	69400	442000
	870000	225000	1690000	1060000	275000	1690000	1060000	275000	1690000	1190000	309000	1970000
1938	56800	14700	97000
1038	253000	65500	431000
1238	143200	37000	239400	175400	45600	239400	100000	26000	161000	205000	53000	299000
5238	637000	164900	1065000	780000	203000	1065000	446000	115000	716000	912000	236000	1330000
	242000	62800	489000	296000	76600	489000	190600	49300	267700	332000	86000	570000
	1080000	279000	2170000	1320000	341000	2170000	848000	219500	1191000	1480000	383000	2540000
1940	73700	19100	125000
1040	328000	84900	556000
1240	123000	31900	201000	150000	38900	201000	121000	31300	193000	175000	45200	246000
5240	547000	142000	893000	668000	173000	893000	538000	139000	859000	777000	201000	1090000
	270000	69900	551000	329000	85300	551000	150000	38900	201000	383000	99200	673000
	1200000	311000	2450000	1460000	379000	2450000	668000	173000	893000	1700000	441000	2990000

Shaft Bearing Seat Diameters

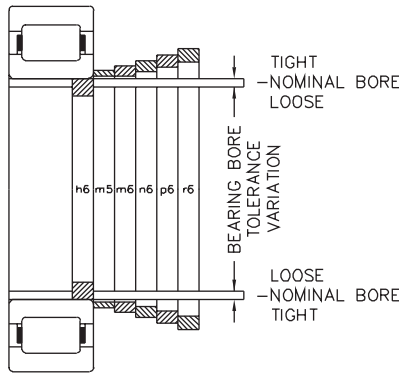

Bearing bore tolerances are in accord with the system of tolerancing established by the International Standards Organization (ISO) and adopted by the American Bearing Manufacturers Association (ABMA) and the American National Standards Institute (ANSI). A system of limits and fits has been established by ISO for shafts. A portion of this system has been adopted by ABMA to provide flexibility in selecting shaft fits. Shaft fits are designated by a lower case letter and a number, such as h6. The letter indicates the location of the shaft tolerance limits with respect to the nominal bearing bore. The number indicates the size of the tolerance zone. Shaft fits recommended for various types of applications are listed in the table at right.

A graphic relationship of various shaft fits is illustrated in the figure at the left. Many factors influence the proper fit of the bearing inner ring on a shaft. The magnitude of the load and its direction with respect to bearing inner or outer rings are generally the first factors considered in shaft fit selection. The effects of other factors such as vibration, shock, temperature, speed, etc., are of secondary importance but sometimes need to be considered. Where assembly or disassembly requirements are of prime importance special shaft fits may be required. Appropriate diameter shafting is determined (as shown) from the tables below.

Class of fit and shaft diameters (inches/um)

Bearing Series, 1000, 1200, 1300, 1900, 5200, 5300, 7300	Nominal bearing bore and shaft diameter		Bearing bore tolerance ▲	Bearing/shaft diameter fits ▲				
				h6		m5		
				Tolerance		Tolerance		
Basic Size	mm	inches	um	inches	Fit	Shaft Dia.	Fit	Shaft Dia.
04	20.000	0.7874	0	0.0000	.0004T	-.0000	.0011T	0.0007
05	25.000	0.9843	-10	-.0004	.0005L	-.0005	.0003T	0.0003
06	30.000	1.1811			10T	0	27T	17
07	35.000	1.3780			13L	-13	8T	8
08	40.000	1.5748	0	0.0000	.0005T	0.0000	.0013T	0.0008
09	45.000	1.7717	-12	-.0005	.0006L	-.0006	.0004T	0.0004
10	50.000	1.9685			12T	0	33T	20
11	55.000	2.1654			16L	-16	9T	9
12	60.000	2.3622			.0006T	0.0000	.0016T	0.001
13	65.000	2.5591	0	0.0000	.0007L	0.0007	.0005T	0.0005
14	70.000	2.7559	-15	-.0006	15T	0	39T	24
15	75.000	2.9528			19L	-19	11T	11
16	80.000	3.1496						
17	85.000	3.3465			.0008T	-.0000	.0019T	0.0011
18	90.000	3.5433	0	0.0000	.0009L	-.0009	.0005T	0.0005
19	95.000	3.7402	-20	-.0008	20T	0	48T	28
20	100.000	3.9370			22L	-22	13T	13
21	105.000	4.1339						
22	110.000	4.3307						
24	120.000	4.7244						
26	130.000	5.1181			.0010T	-.0000	.0023T	0.0013
28	140.000	5.5118	0	0.0000	.0010L	-.0010	.0006T	0.0006
30	150.000	5.9055	-25	-.0010	25T	0	58T	33
32	160.000	6.2992			25L	-25	15T	13
34	170.000	6.6929						
36	180.000	7.0866						
38	190.000	7.4803	0	0.0000	.0012T	0.000	.0026T	0.0014
40	200.000	7.8740	-30	-.0012	.0012L	-.0012	.0006T	0.0006
					30T	0	67T	37
					29L	-29	17T	17

Class of Fit Selection				
Operating conditions ■	Nominal shaft dia.		Class of fit	Remarks
	mm	inches		
Inner ring stationary in relation to direction of load	All diameters		h6	Tap fit inner ring
Inner ring rotating in relation to direction of load (Normal load $m=0.18C$)●	17-40	0.67-1.57	m5	Press fit inner ring
	40-65	1.57-2.56	m6	
	65-140	2.56-5.52	n6	
	140-200	5.52-7.88	p6	
Inner ring rotating in relation to direction of load (Heavy load $>.018C$)●	35-65	1.37-2.56	n6	Heavy press fit inner ring
	65-140	2.56-5.52	p6	
	140-200	5.52-7.88	r6	

Bearing/Shaft diameter fit ▲								
Bearing series 1000, 1200, 1300, 1900, 5200, 5300, 7300	m6		n6		p6		r6	
	Tolerance		Tolerance		Tolerance		Tolerance	
Basic size	Fit	Shaft dia.	Fit	Shaft dia.	Fit	Shaft dia.	Fit	Shaft dia.
04
05
06
07	.0015T	0.0010	.0018T	0.0013
thru	.0004T	0.0004	.0007T	0.0007
10	38T	25	46T	33
	9T	9	17T	17
11	.0018T	0.0012	.0021T	0.0015	.0027T	0.0021
thru	.0005T	0.0005	.0008T	0.0008	.0014T	0.0014
16	45T	30	54T	39	66T	51
	11T	11	20T	20	32T	32
17	.0022T	0.0014	.0027T	0.0019	.0033T	0.0025	.0037T	0.0029
thru	.0005T	0.0005	.0010T	0.0010	.0016T	0.0016	.0020T	0.0020
24	55T	35	65T	45	79T	59	96T	76
	13T	13	23T	23	37T	37	54T	54
26	.0026T	0.0016	.0032T	0.0022	.0038T	0.0028	.0045T	0.0035
thru	.0006T	0.0006	.0012T	0.0012	.0018T	0.0018	.0025T	0.0025
36	65T	40	77T	52	93T	68	118T	93
	15T	15	27T	27	43T	43	68T	68
	.0030T	0.0018	.0038T	0.0026	.0044T	0.0032	.0054T	0.0042
38	.0006T	0.0006	.0014T	0.0014	.0020T	0.0020	.0030T	0.0030
40	76T	46	90T	60	109T	79	136T	106
	17T	17	31T	31	50T	50	77T	77

▲ Symbol L indicates a loose or clearance fit. Symbol T indicates a tight or interference fit. The appropriate shaft diameter for any class of fit can be easily determined by applying the shaft tolerance to the nominal shaft diameter. Example: (Using basic bearing size 03 and fit class h6)

	inches	mm
Nominal shaft diameter	= .6693 .6693	= 17.000 17.000
Shaft diameter tolerance	= +.0000 -.0004	= + 0.000 -0.010

▲ The arithmetical mean of the largest and smallest single diameter to be within tolerance shown. Allowable deviations from mean diameter per ANSI/ABMA STD 20, latest printing.

Resultant shaft diameter = .6693 .6689 = 17.000 16.989

1µm = .001 mm

■ For solid steel shafts.

● C = Basic load rating of bearing.

Housing Bearing Seat Diameters

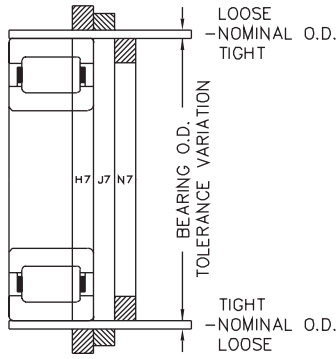

Bearing outside diameter tolerances are in accord with the system of tolerancing established by the International Standards Organization (ISO) and adopted by the American Bearing Manufacturers Association (ABMA) and the American National Standards Institute (ANSI).

A system of limits and fits has been established by ISO for holes. A portion of this system has been adopted by ABMA to provide flexibility in selecting housing fits. Housing fits are designated by a capital letter and a number such as H7. The letter indicates the location of the housing bore tolerance limits with respect to the nominal bearing O.D. The number indicates the size of the tolerance zone.

Housing fits recommended for various types of applications are listed in the table at the right. A graphic relationship of various housing

fits is illustrated in the figure at the left. The class of fit is determined by nature of loading (oscillating, vibrating, reversing, etc.), axial movement requirements, temperature conditions, housing material and cross section of housing.

Shaft expansion increases bearing center distances and requires all but one bearing on a shaft to be movable axially in the housing. In most bearings the outer rings are subjected to stationary loads which permit a loose housing fit.

Operating temperature may affect the housing fit, as the housing may dissipate heat rapidly and not expand with the outer ring. However, the loose fit must never be greater than necessary. Excessive looseness results in less accurate shaft centering and additional ring deformation under load.

The appropriate housing bores are determined (as shown) from the tables below.

Class of fit and housing bores (inches/ μ m)

Bearing series		Nominal bearing O.D. and housing bore		Bearing O.D. tolerance Δ	Bearing/Housing diameter fits \blacktriangle								
1900	1000	1200	1300		H7		J7		N7				
					Tolerance		Tolerance		Tolerance				
Basic Size		mm	inches	Fit	Housing Bore	Fit	Housing Bore	Fit	Housing Bore				
...	...	205	304	52	2.0472	0	0	.0004T	-0.0004	.0002L	-0.0003		
...	...	206	305	62	2.4409	-.0005	.0017L	0.0012	.0013L	\neq .0008	.0015T	-0.0015	
...	...	207	306	72	2.8346	0	0	12T	-12	4L	-9		
911	010	208	307	80	3.1496	-13	43L	30	31L	-18	39T	-39	
912	...	209	...	85	3.3465	0	0	0	0	.0005T	-0.0005	.0002L	-0.0004
913	011	210	308	90	3.5433	0	0	0	0	.0005T	-0.0005	.0002L	-0.0004
...	012	95	3.7402	0	0	0	0	.0005T	-0.0005	.0002L	-0.0004
914	013	211	309	100	3.9370	-.0006	.0020L	0.0014	.0015L	0.0009	.0018T	-0.0018	
915	105	4.1339	0	0	0	0	13T	-13	5L	-10
916	014	212	310	110	4.3307	-15	50L	35	37L	22	45T	-45	
...	015	115	4.5276	0	0	0	0	.0006T	-0.0006	.0002L	-0.0006
917	...	213	311	120	4.7244	0	0	0	0	.0006T	-0.0006	.0002L	-0.0006
918	016	214	...	125	4.9213	0	0	0	0	.0006T	-0.0006	.0002L	-0.0006
919	017	215	312	130	5.1181	-.0008	.0024L	0.0016	.0018L	0.0010	.0022T	-0.0022	
920	018	216	313	140	5.5118	0	0	0	0	14T	-14	6L	-12
921	019	145	5.7087	-20	61L	41	44L	26	52T	-52	
922	020	217	314	150	5.9055	0	0	0	0	.0006T	-0.0006	.0004L	-0.0006
...	021	218	315	160	6.2992	0	0	0	0	.0006T	-0.0006	.0004L	-0.0006
924	165	6.4961	-.0010	.0026L	0.0016	.0020L	0.001	.0022T	-0.0022	
...	022	219	316	170	6.6929	0	0	0	0	14T	-14	13L	-12
926	024	220	317	180	7.0866	-25	65L	40	51L	26	57T	-52	
928	...	221	318	190	7.4803	0	0	0	0	.0007T	-0.0007	.0004L	-0.0008
...	026	222	319	200	7.8740	0	0	0	0	.0007T	-0.0007	.0004L	-0.0008
930	028	210	8.2677	0	0	0	0	.0007T	-0.0007	.0004L	-0.0008
...	...	224	320	215	8.4646	-0.0012	.0030L	0.0018	.0023L	0.0011	.0026T	-0.0026	
932	321	220	8.6614	0	0	0	0	16T	-16	16L	-14
...	030	225	8.8583	0	0	0	0	16T	-16	16L	-14
934	...	226	322	230	9.0551	-30	76L	46	60L	30	60T	-60	
...	032	240	9.4488	0	0	0	0	.0007T	-0.0007	.0006L	-0.0008
936	...	228	...	250	9.8425	0	0	0	0	.0007T	-0.0007	.0006L	-0.0008
938	034	...	324	260	10.2362	0	0	0	0	.0007T	-0.0007	.0006L	-0.0008
...	...	230	...	270	10.6299	-.0014	.0034L	0.002	.0027L	0.0013	.0028T	-0.0028	
940	036	...	326	280	11.0236	0	0	0	0	16T	-16	21L	-14
...	038	232	...	290	11.4173	-35	87L	52	71L	36	66T	-66	
...	328	300	11.8110	0	0	0	0	.0007T	-0.0007	.0008L	-0.0008
...	040	234	...	310	12.2047	0	0	0	0	.0007T	-0.0007	.0008L	-0.0008
...	...	236	330	320	12.5984	-.0016	.0038L	0.0022	.0030L	0.0014	.0030T	-0.003	
...	...	238	...	340	13.3858	0	0	0	0	8T	-18	24L	-16
...	...	240	...	360	14.1732	-40	97L	57	79L	39	73T	-73	

1 μ m = .001 mm

□ Minimum housing bore is same as ABMA fit class; tolerance is within ABMA range.

■ Style A outer ring has oversize O.D. designed to give a heavy press fit with a tap fit housing bore. Inner ring to be press fit for values.

Δ The arithmetical mean of the largest and smallest single diameter to be within tolerance shown.

Allowable deviations from mean diameter per ANSI/ABMA STD 20, latest printing.

Class of fit Selection		
Operating conditions	Class of fit	Remarks
Housing stationary in relation to direction of load	H7	Push fit outer ring for non-separable bearing styles MU...UV and MU...UM
Housing stationary in relation to direction of load	J7□	Tap fit outer ring
Housing rotating in relation to direction of load	N7□	Press fit outer ring
	■	Heavy press fit with Style A outer ring

Heavy press fit with style A outer ring (inches/μm)										
Bearing series				Nominal bearing O.D. and housing bore Style A outer ring		Bearing O.D. tolerance Δ	Bearing/housing diameter fits ▲			
1900	1000	1200 5200	1300 5300 7300				Tolerance			
Basic Size				mm	inches		Fit		Housing bore	
...	...	205	304	52.024	2.0482	0.0000	.00000	0	-.0005	-13
...	...	206	305	62.029	2.4421	0	.0001T	2T	-.0006	-15
...	...	207	306	72.032	2.8359	-13	.0016T	40T	-.0016	-40
...	...	208	307	80.035	3.151	0	.0002T	5T	-.0007	-18
911	010	208	307	80.035	3.151	0	.0017T	43T	-.0017	-43
...	...	209	...	85.039	3.348	0	.0003T	7T	-.0008	-20
912	...	209	...	85.039	3.348	0	.0018T	45T	-.0018	-45
913	011	210	308	90.04	3.5449	0	.0004T	10T	-.0010	-25
...	012	95.044	3.7419	0.0000	.0020T	50T	-.0020	-50
914	013	211	309	100.046	3.9388	-0.0006	.0005T	13T	-.0011	-28
...	...	212	310	110.056	4.3329	0	.0021T	53T	-.0021	-53
915	...	213	311	120.056	4.7266	-0.0006	.0006T	15T	-.0012	-30
916	014	212	310	110.056	4.3329	0	.0022T	56T	-.0022	-56
...	015	115.057	4.5298	0	.0007T	18T	-.0013	-33
917	...	213	311	120.056	4.7266	-15	.0023T	58T	-.0023	-58
918	016	214	312	130.058	5.1204	0	.0008T	20T	-.0014	-35
919	017	215	313	140.058	5.5141	0	.0024T	61T	-.0024	-61
920	018	216	314	150.066	5.9081	0	.0009T	23T	-.0017	-38
921	019	217	315	160.071	6.302	-0.0008	.0027T	69T	-.0027	-69
922	020	218	316	170.071	6.6957	0	.0009T	23T	-.0017	-38
...	021	219	317	180.071	7.0894	-20	.0027T	69T	-.0027	-69
924	...	218	315	160.071	6.302	0.0000	.0009T	23T	-.0017	-43
...	022	219	316	170.071	6.6957	-0.0010	.0029T	74T	-.0029	-74
926	024	220	317	180.071	7.0894	0	.0010T	25T	-.0018	-45
...	...	221	318	190.076	7.4833	-25	.0032T	81T	-.0032	-81
928	...	222	319	200.078	7.8771	0	.0010T	25T	-.0020	-50
...	026	222	319	200.078	7.8771	-0.0012	.0034T	86T	-.0034	-86
930	028	210.081	8.2709	0	.0011T	28T	-.0023	-58
...	...	224	320	215.087	8.468	0	.0037T	94T	-.0037	-94
932	220.088	8.6649	0	.0012T	30T	-.0024	-60
...	030	...	321	225.09	8.8618	0	.0012T	30T	-.0024	-60
934	...	226	...	230.091	9.0587	0	.0013T	33T	-.0025	-63
...	...	228	...	250.096	9.8463	0	.0013T	33T	-.0025	-63
936	...	228	...	250.096	9.8463	-30	.0039T	99T	-.0039	-99
...	032	...	322	240.096	9.4526	0	.0013T	33T	-.0025	-63
...	...	236	330	320.121	12.6032	0	.0041T	104T	-.0041	-104
...	...	238	...	340.121	13.3906	0	.0014T	36T	-.0026	-66
...	...	240	...	360.124	14.1781	-40	.0042T	107T	-.0042	-107
...	...	240	...	360.124	14.1781	0	.0015T	38T	-.0027	-68
...	...	240	...	360.124	14.1781	0	.0043T	109T	-.0043	-109
...	...	240	...	360.124	14.1781	0	.0015T	38T	-.0027	-68
...	...	240	...	360.124	14.1781	-40	.0045T	114T	-.0045	-114
938	034	...	324	260.101	10.2402	0.0000	.0015T	38T	-.0029	-73
...	...	230	...	270.101	10.6339	-0.0014	.0047T	119T	-.0047	-119
940	036	...	326	280.101	11.0276	0	.0016T	41T	-.0030	-76
...	038	232	...	290.109	11.4216	-35	.0050T	127T	-.0050	-127
...	328	300.111	11.8154	0	.0017T	43T	-.0031	-78
...	040	234	...	310.111	12.2091	0	.0051T	130T	-.0051	-130
...	...	236	330	320.121	12.6032	0.0000	.0017T	43T	-.0033	-83
...	...	238	...	340.121	13.3906	-0.0016	.0055T	140T	-.0055	-140
...	...	240	...	360.124	14.1781	0	.0018T	46T	-.0043	-86
...	...	240	...	360.124	14.1781	-40	.0056T	142T	-.0056	-142

▲ Symbol L indicates a loose or clearance fit. Symbol T indicates a tight or interference fit. The appropriate housing bore for any class of fit can be easily determined by applying the housing tolerance to the nominal housing bore. Example: (Using basic bearing size 926 and fit class N7)

Nominal housing bore	= 7.0866 7.0866 =	180.000 180.000
Housing bore tolerance	= -.0006 -.0022 =	-.012 -.052
Resultant housing bore	= 7.0860 7.0844 =	179.988 179.948

Operation Without Inner Ring/ Outer Ring

Outer ring and roller assembly

for Series M-EX, M-EAX, M-EB, M-EAB, M-TV, M-TAV, M-UV and M-UAV

Cylindrical roller bearings with the inner ring omitted may be installed so that the rollers operate directly on the surface of the shaft.

This type of design is useful for applications where space is limited or a larger shaft is required. Surface hardness of shaft must be Rockwell C59 to C64 to achieve full bearing capacity. Where the required hardness cannot be attained, the bearing rating must be reduced accordingly. Where the shaft is case hardened, the combination of case depth and core hardness must be adequate. Consult Rexnord Bearing Division for a specific recommendation. Shaft surface should be finished to a roughness value of 13 micro-inches, RMS, maximum (.33 μm). Maximum and minimum shaft diameter values for tap fit and press fit outer rings are listed below.

Hardness factor

If operation at rated capacity is desired when cylindrical roller bearings are used with either ring omitted, the surface on which the rollers operate must have a hardness of Rockwell C59 to C64 or equivalent Brinell hardness (see chart below). If this hardness cannot be attained, the bearing C capacity must be reduced by a rating reduction factor determined from chart on facing page.

Inner ring and roller assembly

for Series MU-X, MU-B

Cylindrical roller bearings with the outer ring omitted may be installed so that the rollers operate directly on the hardened and ground surface of a bore in an alloy steel housing.

This type of design is useful for applications where space is limited and a smaller housing bore or a larger bearing and shaft are required. Housing surface hardness must be Rockwell C59 to

C64 or Brinell equivalent to achieve full bearing capacity. Where the required hardness cannot be attained, the bearing rating must be reduced accordingly. See graph for rating reduction factor. Where the housing bore is case hardened, the combination of case depth and core hardness must be adequate. Consult Rexnord Bearing Division for a specific recommendation. Housing surface should be finished to a roughness value of 13 micro-inches, A.A., maximum (.33 μm).

Maximum and minimum housing bore values for tap fit and press fit inner rings are listed on the next page.

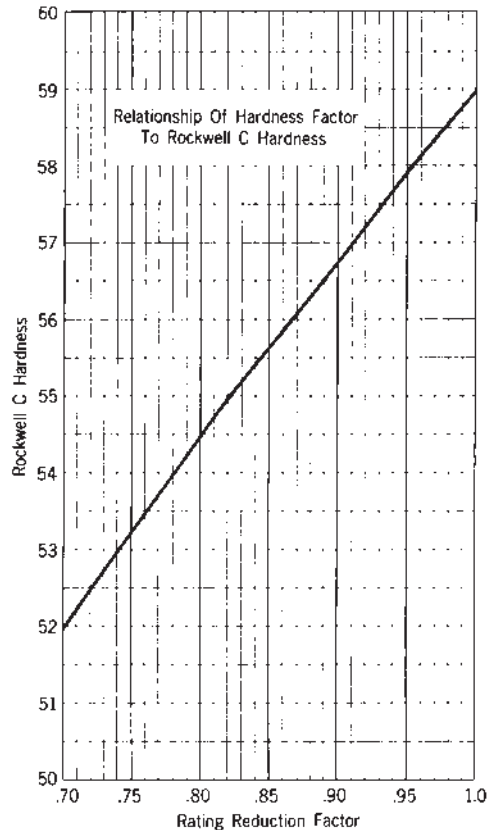
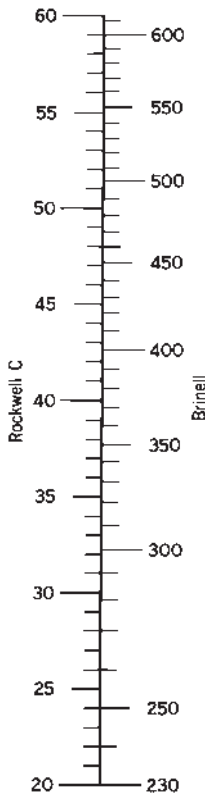
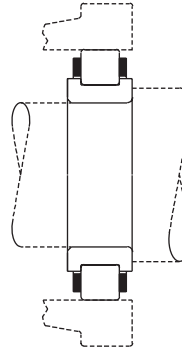
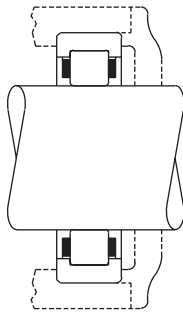

Shaft Diameters for Outer Ring																								
Shaft diameter for tap fit outer ring ▲									Shaft diameter for press fit outer ring															
Bearing series	1900		1000		1200-5200		1300-5300-7300		1900		1000		1200-5200		1300-5300-7300									
Basic size	(max-min)								inches								(max-min)							
03	0.8757	0.8753	0.8725	0.8721	0.9803	0.9799	0.8750	0.8746	0.8718	0.8714	0.9796	0.9792								
04	0.9769	0.9765	1.0329	1.0325	1.1092	1.1087	1.1013	1.1008	0.9762	0.9758	1.0322	1.0318	1.1085	1.1080	1.1005	1.1000								
05	1.1759	1.1754	1.2259	1.2254	1.2672	1.2667	1.3383	1.3378	1.1753	1.1748	1.2253	1.2248	1.2665	1.2660	1.3376	1.3371								
06	1.3710	1.3705	1.4523	1.4518	1.4994	1.4989	1.6024	1.6019	1.3704	1.3699	1.4515	1.4510	1.4986	1.4981	1.6016	1.6011								
07	1.6112	1.6107	1.6611	1.6606	1.7322	1.7317	1.8452	1.8447	1.6104	1.6099	1.6603	1.6598	1.7314	1.7309	1.8444	1.8439								
08	1.8061	1.8056	1.8777	1.8772	1.9667	1.9662	2.0600	2.0595	1.8054	1.8049	1.8770	1.8765	1.9660	1.9655	2.0590	2.0585								
09	2.0263	2.0258	2.0831	2.0825	2.1870	2.1864	2.3382	2.3376	2.0255	2.0250	2.0823	2.0817	2.1861	2.1855	2.3373	2.3367								
10	2.2014	2.2008	2.2802	2.2796	2.3816	2.3810	2.5660	2.5654	2.2006	2.2000	2.2794	2.2788	2.3807	2.3801	2.5651	2.5645								
11	2.4316	2.4310	2.5408	2.5402	2.6354	2.6348	2.8136	2.8130	2.4308	2.4302	2.5398	2.5392	2.6344	2.6338	2.8127	2.8121								
12	2.6316	2.6310	2.7377	2.7371	2.8511	2.8505	3.0545	3.0538	2.6307	2.6301	2.7368	2.7362	2.8502	2.8496	3.0534	3.0527								
13	2.8267	2.8261	2.9348	2.9341	3.1677	3.1670	3.2957	3.2950	2.8258	2.8252	2.9339	2.9332	3.1668	3.1661	3.2946	3.2939								
14	3.0719	3.0712	3.1588	3.1581	3.3392	3.3385	3.5132	3.5125	3.0710	3.0703	3.1579	3.1572	3.3381	3.3374	3.5120	3.5113								
15	3.2669	3.2662	3.3569	3.3562	3.5063	3.5056	3.7780	3.7772	3.2660	3.2653	3.3560	3.3553	3.5052	3.5045	3.7769	3.7761								
16	3.4619	3.4612	3.5969	3.5962	3.7532	3.7525	4.0031	4.0023	3.4610	3.4603	3.5958	3.5951	3.7520	3.7513	4.0020	4.0012								
17	3.7274	3.7267	3.7944	3.7936	4.0182	4.0174	4.2746	4.2738	3.7265	3.7258	3.7933	3.7925	4.0171	4.0163	4.2735	4.2727								
18	3.9225	3.9217	4.0324	4.0316	4.2235	4.2227	4.4915	4.4907	3.9214	3.9206	4.0313	4.0305	4.2224	4.2216	4.4902	4.4894								
19	4.1174	4.1166	4.2284	4.2276	4.4714	4.4706	4.8113	4.8105	4.1163	4.1155	4.2273	4.2265	4.4703	4.4695	4.8099	4.8091								
20	4.3330	4.3322	4.4254	4.4246	4.7663	4.7655	5.1267	5.1258	4.3319	4.3311	4.4243	4.4235	4.7652	4.7644	5.1254	5.1245								

Housing Bore for Outer Ring																								
Housing bore for tap fit inner ring									Housing bore for press fit inner ring															
Bearing series	1900		1000		1200-5200		1300-5300-7300		1900		1000		1200-5200		1300-5300-7300									
Basic size	(max-min)								inches								(max-min)							
03	1.1992	1.1988	1.3708	1.3704	1.5402	1.5398	1.1996	1.1992	1.3712	1.3708	1.5406	1.5402								
04	1.2689	1.2685	1.4383	1.4379	1.6075	1.6070	1.7305	1.7300	1.2694	1.2690	1.4388	1.4384	1.6080	1.6075	1.7309	1.7304								
05	1.4680	1.4675	1.6314	1.6309	1.7656	1.7651	2.1031	2.1026	1.4686	1.4681	1.6320	1.6315	1.7661	1.7656	2.1036	2.1031								
06	1.6631	1.6626	2.9090	1.9085	2.1285	2.1280	2.3780	2.3775	1.6637	1.6632	1.9096	1.9091	2.1291	2.1286	2.3785	2.3780								
07	1.9346	1.9341	2.1594	2.1589	2.4591	2.4586	2.6745	2.6740	1.9353	1.9348	2.1600	2.1595	2.4597	2.4592	2.6751	2.6746								
08	2.2116	2.2111	2.3760	2.3755	2.7405	2.7400	3.0572	3.0567	2.2123	2.2118	2.3767	2.3762	2.7411	2.7406	3.0578	3.0573								
09	2.4317	2.4312	2.6430	2.6424	2.9517	2.9511	3.3894	3.3888	2.4325	2.4320	2.6438	2.6432	2.9526	2.9520	3.3902	3.3896								
10	2.6068	2.6062	2.8400	2.8394	3.1311	3.1305	3.7195	3.7189	2.6077	2.6071	2.8409	2.8403	3.1319	3.1313	3.7203	3.7197								
11	2.8881	2.8875	3.1697	3.1691	3.4646	3.4640	4.0784	4.0778	2.8892	2.8886	3.1707	3.1701	3.4656	3.4650	4.0793	4.0787								
12	3.0882	3.0876	3.3668	3.3662	3.8481	3.8475	4.4280	4.4273	3.0893	3.0887	3.3678	3.3672	3.8491	3.8485	4.4289	4.4282								
13	3.2832	3.2826	3.5639	3.5632	4.1649	4.1642	4.7775	4.7768	3.2843	3.2837	3.5649	3.5642	4.1658	4.1651	4.7758	4.7751								
14	3.6316	3.6309	3.9323	3.9316	4.3902	4.3895	5.0926	5.0919	3.6329	3.6322	3.9337	3.9330	4.3915	4.3908	5.0938	5.0931								
15	3.8266	3.8259	4.1304	4.1297	4.5573	4.5566	5.4770	5.4762	3.8280	3.8273	4.1317	4.1310	4.5585	4.5578	5.4782	5.4774								
16	4.0217	4.0210	Δ	Δ	4.9068	4.9061	5.8033	5.8025	4.0230	4.0223	Δ	Δ	4.9081	4.9074	5.8045	5.8037								
17	4.3561	4.3554	4.6515	4.6507	5.2829	5.2821	6.1966	6.1958	4.3578	4.3571	4.6772	4.6764	5.2845	5.2837	6.1981	6.1973								
18	4.5512	4.5504	5.0292	5.0284	5.5968	5.5960	6.5109	6.5101	4.5529	4.5521	5.0309	5.0301	5.5984	5.5976	6.5124	6.5116								
19	4.7463	4.7455	5.2253	5.2245	5.9532	5.9524	6.8308	6.8300	4.7480	4.7472	5.2269	5.2261	5.9548	5.9540	6.8322	6.8314								
20	5.1064	5.1056	Δ	Δ	6.3459	6.3451	7.2787	7.2778	5.1082	5.1074	Δ	Δ	6.3474	6.3466	7.2802	7.2793								

For shaft diameters larger than above, consult Rexnord Bearing Division.

Δ For size, consult Rexnord Bearing Division.

▲ Shaft diameter limits also apply to Style A outer ring bearings.

■ Hultgren 10 mm ball penetrator; 3000 kg load.

□ Brale penetrator; 150 kg load.

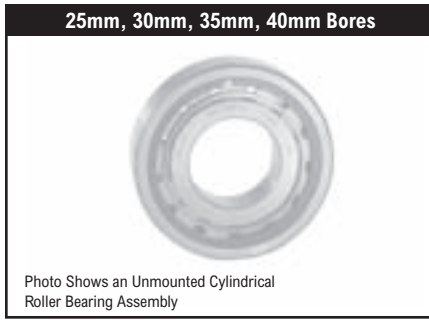

Product Features

- Fully crowned rollers
- Precision ground ribs
- Contoured roller pockets
- Rollers individually separated
- Optional full complement
- See Features & Benefits for additional info.

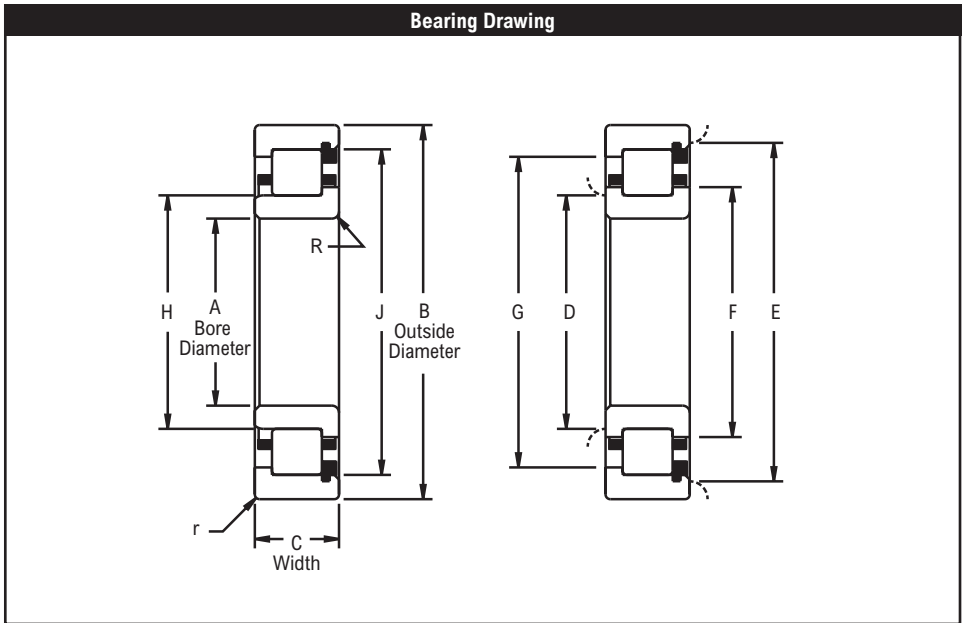

Bearing Dimensions

Basic Bearing Number	A Bore Diameter		B Outside Diameter		C Bearing Width		D		E		F	G	H	J	R	r
	mm	in	mm	in	mm	in	Plain	Ribbed	Plain	Ribbed						
1205	25.0000	0.9843	52.0000	2.0472	15.0000	0.5906	30.50	32.00	47.00	44.70	34.32	42.95	32.166	44.854	1.02	1.02
5205					20.6380	0.8125										
1305					17.0000	0.6693										
7305					21.0000	0.8268										
5305			62.0000	2.4409	25.4000	1.0000	31.50	33.80	55.90	53.30	37.49	50.14	33.972	53.426		
1206	30.0000	1.1811	62.0000	2.4409	16.0000	0.6299	36.10	37.80	56.40	53.80	40.87	51.48	38.062	54.074	1.02	1.02
5206					23.8120	0.9375										
1306					19.0000	0.7480										
7306					23.0000	0.9055										
5306			72.0000	2.8346	30.1620	1.1875	37.80	40.60	64.00	60.20	44.25	56.87	40.681	60.409	1.52	
1207	35.0000	1.3780	72.0000	2.8346	17.0000	0.6693	41.60	43.90	65.30	62.20	47.29	59.51	43.970	62.471	1.02	1.02
5207					26.9980	1.0629										
1307					21.0000	0.8268										
7307					26.0000	1.0236										
5307			80.0000	3.1496	34.9250	1.3750	43.70	46.70	71.40	67.80	50.67	64.46	46.843	67.942	1.52	1.52
1208	40.0000	1.5748	80.0000	3.1496	18.0000	0.7087	47.20	49.80	72.90	69.60	53.44	66.42	49.929	69.619	1.52	1.02
5208					30.1620	1.1875										
1308					23.0000	0.9055										
7308					30.0000	1.1811										
5308			90.0000	3.5433	36.5120	1.4375	49.00	52.10	81.30	77.50	57.00	73.33	52.299	77.663		1.52

Additional Notes

Please call 1-866-REXNORD for availability
 Dimensions "R" & "r", largest fillet radius that will clear bearing corners
 Selection Guide, see Link-Belt Cylindrical Roller Bearing Selection Guide section
 Load Ratings & Speed Limits, see Link-Belt Cylindrical Roller Bearing Load Ratings & Speed Limits section
 For shaft and housing bearing seat diameters, see Link-Belt Cylindrical Bearing Shaft & Housing Seat Diameters section

Note: Dimensions subject to change. Certified dimensions of ordered material furnished on request.

45mm, 50mm, 55mm Bores

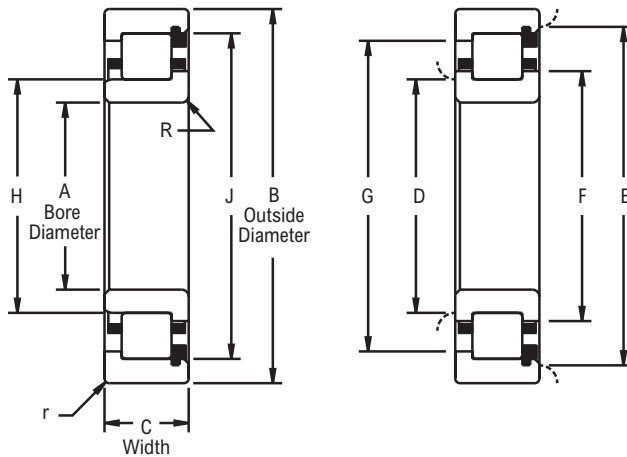

Photo Shows an Unmounted Cylindrical Roller Bearing Assembly

Product Features

- Fully crowned rollers
- Precision ground ribs
- Contoured roller pockets
- Rollers individually separated
- Optional full complement
- See Features & Benefits for additional info.

Bearing Drawing



Bearing Dimensions

Basic Bearing Number	A Bore Diameter		B Outside Diameter		C Bearing Width		D		E		F	G	H	J	R	r
	mm	in	mm	in	mm	in	Plain	Ribbed	Plain	Ribbed						
1209	45.0000	1.7717	85.0000	3.3465	19.0000	0.7480	52.80	55.40	78.20	74.90	59.03	71.80	55.519	74.988	1.52	1.02
5209					30.1620	1.1875										
1309					25.0000	0.9843										
7309					31.0000	1.2205										
5309					39.6880	1.5625										
1010	50.0000	1.9685	80.0000	3.1496	16.0000	0.6299	56.10	57.60	74.40	72.10	60.43	69.62	57.882	72.151	1.52	1.02
1210					20.0000	0.7874										
5210					30.1620	1.1875										
1310					27.0000	1.0630										
7310					33.0000	1.2992										
5310	44.4500	1.7500														
1911	55.0000	2.1654	80.0000	3.1496	13.0000	0.5118	59.90	61.70	75.20	73.20	64.26	70.84	61.722	73.378	1.02	1.02
1011					18.0000	0.7087										
1211					21.0000	0.8268										
5211					33.3380	1.3125										
1311					29.0000	1.1417										
7311	36.0000	1.4173														
5311	49.2120	1.9375														

Additional Notes

Please call 1-866-REXNORD for availability
 Dimensions "R" and "r", largest fillet radius that will clear bearing corners
 Selection Guide, see Link-Belt Cylindrical Roller Bearing Selection Guide section
 Load Ratings & Speed Limits, see Link-Belt Cylindrical Roller Bearing Load Ratings & Speed Limits section
 For shaft and housing bearing seat diameters, see Link-Belt Cylindrical Bearing Shaft & Housing Seat Diameters section

Note: Dimensions subject to change. Certified dimensions of ordered material furnished on request.

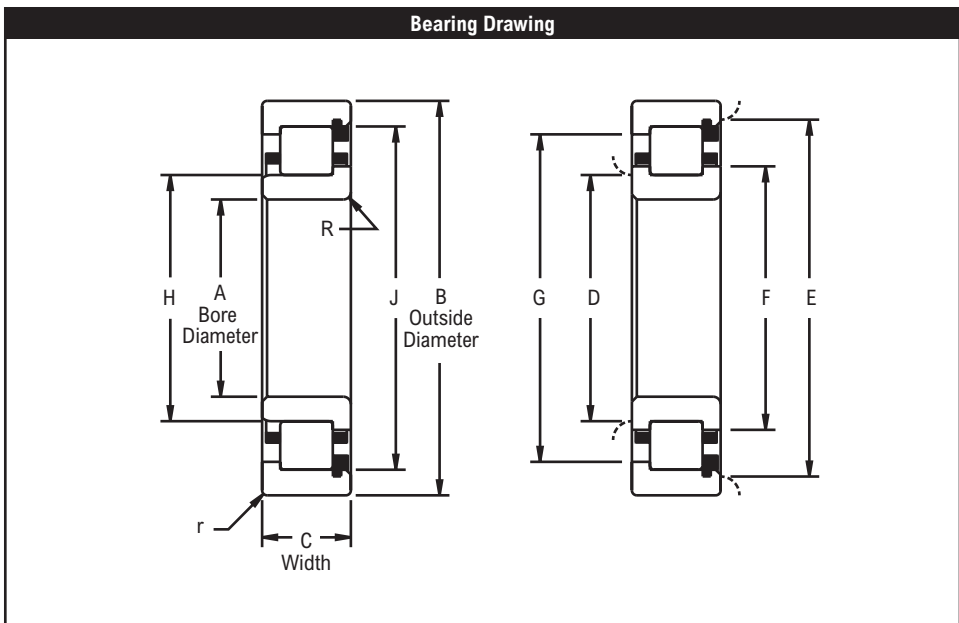
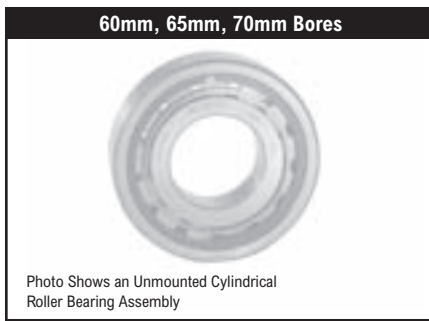

Product Features

- Fully crowned rollers
- Precision ground ribs
- Contoured roller pockets
- Rollers individually separated
- Optional full complement
- See Features & Benefits for additional info.

Bearing Dimensions

Basic Bearing Number	A Bore Diameter		B Outside Diameter		C Bearing Width		D		E		F	G	H	J	R	r	
	mm	in	mm	in	mm	in	Plain	Ribbed	Plain	Ribbed							
1912	60.000	2.3622	85.0000	3.3465	13.0000	0.5118	65.00	66.80	80.30	78.20	69.34	75.92	66.802	78.461	1.02	1.02	
1012			95.0000	3.7402	18.0000	0.7087	67.00	69.30	88.60	85.30	72.69	82.35	69.499	85.534	1.52		
1212			110.0000	4.3307	22.0000	0.8661	69.30	72.10	101.30	97.50	76.94	93.50	72.380	97.762	2.03		
5212			36.5120	1.4375													
1312			130.0000	5.1181	31.0000	1.2205	72.90	77.50	117.80	112.30	84.02	106.35	77.551	112.486	2.54		2.03
7312					38.0000	1.4961											
5312					53.9750	2.1250											
1913	90.0000	3.5433			13.0000	0.5118										70.10	
1013	100.0000	3.9370	18.0000	0.7087	72.10	74.40	93.70	90.40	77.72	87.35	74.503	90.541	1.52				
1213	65.000	2.5591	23.0000	0.9055	77.00	80.30	110.00	105.70	85.34	101.24	80.421	105.804	2.54	1.52			
5213			38.1000	1.5000													
1313			33.0000	1.2992													
7313			140.0000	5.5118	40.0000	1.5748	78.70	83.60	127.00	121.20	90.70	114.68	83.675	121.366	2.03		
5313			58.7380	2.3125													
1914	70.000	2.7559	100.0000	3.9370	16.0000	0.6299	75.90	78.00	94.50	92.20	80.82	89.41	77.978	92.268	1.02	1.02	
1014			110.0000	4.3307	20.0000	0.7874	77.50	80.00	103.40	99.80	84.12	95.99	80.188	99.906	2.03		
1214			125.0000	4.9213	24.0000	0.9449	81.80	84.60	115.60	111.50	89.61	107.01	84.772	111.536	2.54		1.52
5214			39.6880	1.5625													
1314			35.0000	1.3780													
7314			150.0000	5.9055	43.0000	1.6929	84.30	89.20	135.60	129.30	96.72	122.20	89.192	129.375	3.18		2.03
5314			63.6000	2.5039													

Additional Notes

Please call 1-866-REXNORD for availability
 Dimensions "R" & "r", largest fillet radius that will clear bearing corners
 Selection Guide, see Link-Belt Cylindrical Roller Bearing Selection Guide section
 Load Ratings & Speed Limits, see Link-Belt Cylindrical Roller Bearing Load Ratings & Speed Limits section
 For shaft and housing bearing seat diameters, see Link-Belt Cylindrical Bearing Shaft & Housing Seat Diameters section

Note: Dimensions subject to change. Certified dimensions of ordered material furnished on request.

75mm, 80mm, 85mm Bores

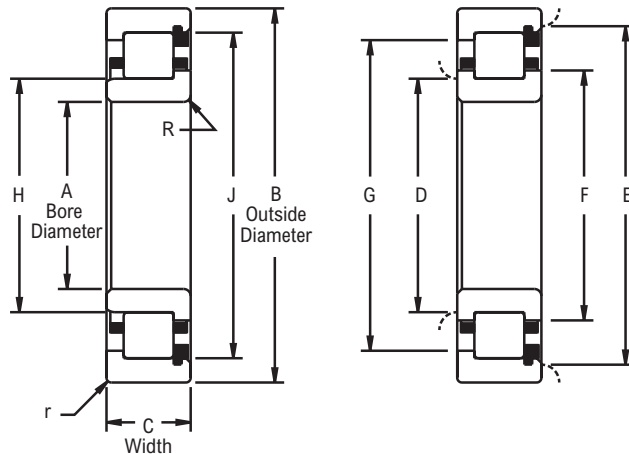

Photo Shows an Unmounted Cylindrical Roller Bearing Assembly

Product Features

- Fully crowned rollers
- Precision ground ribs
- Contoured roller pockets
- Rollers individually separated
- Optional full complement
- See Features & Benefits for additional info.

Bearing Drawing



Bearing Dimensions

Basic Bearing Number	A Bore Diameter		B Outside Diameter		C Bearing Width		D		E		F	G	H	J	R	r	
	mm	in	mm	in	mm	in	Plain	Ribbed	Plain	Ribbed							
1915	75.0000	2.9528	105.0000	4.1339	16.0000	0.6299	80.80	82.80	99.60	97.00	85.78	94.39	82.931	97.221	1.02	1.02	
1015			115.0000	4.5276	20.0000	0.7874	82.60	85.10	108.40	104.90	89.15	101.02	85.217	104.938	2.03		
1215			130.0000	5.1181	25.0000	0.9843	85.60	88.90	120.10	115.60	93.85	111.25	89.014	115.781	2.54		1.52
5215			41.2750	1.6250													
1315			37.0000	1.4567													2.03
7315			46.0000	1.8110	160.0000	6.2992	90.40	95.80	145.80	138.90	104.04	131.37	95.920	139.136	3.18		
5315	68.2620	2.6875															
1916	80.0000	3.1496	110.0000	4.3307	16.0000	0.6299	85.80	87.90	104.40	102.10	90.73	99.34	87.884	102.176	1.02	1.02	
1016			125.0000	4.9213	22.0000	0.8661	88.40	91.20	117.60	113.50	95.71	109.45	91.313	113.088	2.03		
1216			140.0000	5.5118	26.0000	1.0236	91.20	95.20	129.30	124.50	100.79	119.38	95.286	124.658	2.54		2.03
5216			44.4500	1.7500													
1316			39.0000	1.5354													3.18
7316			49.0000	1.9291	170.0000	6.6929	96.00	101.60	154.40	147.30	110.29	139.19	101.636	147.424	3.18		
5316	68.2620	2.6875															
1917	85.0000	3.3465	120.0000	4.7244	18.0000	0.7087	92.20	94.50	113.80	101.50	97.82	107.47	94.615	110.678	1.52	1.02	
1017			130.0000	5.1181	22.0000	0.8661	93.50	96.30	122.70	118.60	100.63	114.48	96.317	118.173	2.03		
1217			150.0000	5.9055	28.0000	1.1024	98.00	101.80	139.20	134.10	108.05	128.42	102.006	134.216	3.18		2.03
5217			49.2120	1.9375													
1317			41.0000	1.6142													2.54
7317			51.0000	2.0079	180.0000	7.0866	102.90	108.40	164.30	157.20	118.24	148.64	108.522	157.422	3.96		
5317	73.0250	2.8750															

Additional Notes

Please call 1-866-REXNORD for availability
 Dimensions "R" & "r", largest fillet radius that will clear bearing corners
 Selection Guide, see Link-Belt Cylindrical Roller Bearing Selection Guide section
 Load Ratings & Speed Limits, see Link-Belt Cylindrical Roller Bearing Load Ratings & Speed Limits section
 For shaft and housing bearing seat diameters, see Link-Belt Cylindrical Bearing Shaft & Housing Seat Diameters section

Note: Dimensions subject to change. Certified dimensions of ordered material furnished on request.

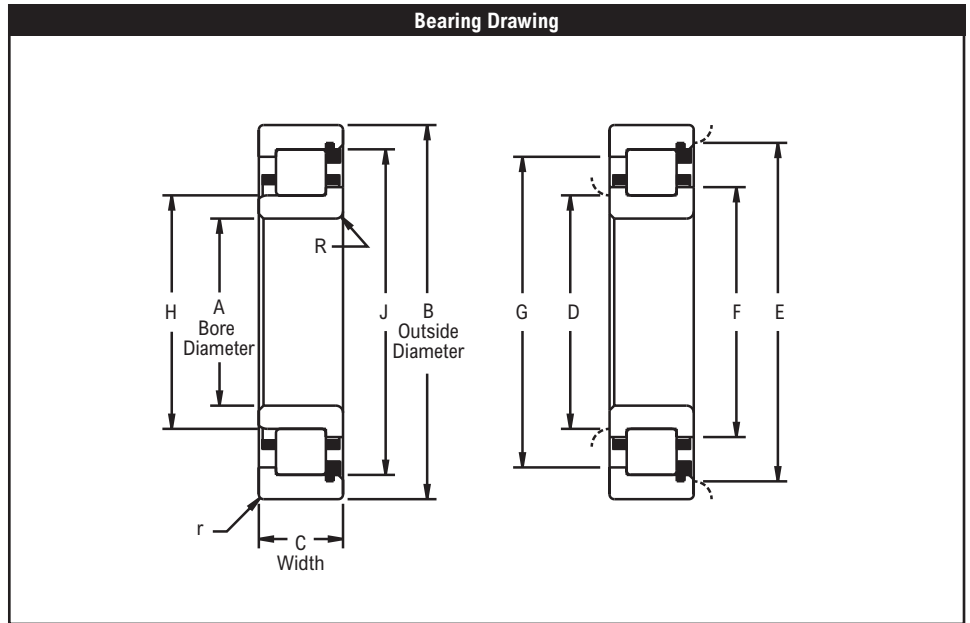
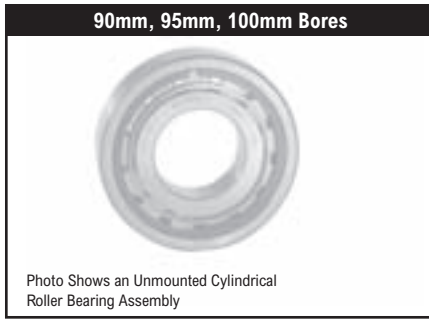

Product Features

- Fully crowned rollers
- Precision ground ribs
- Contoured roller pockets
- Rollers individually separated
- Optional full complement
- See Features & Benefits for additional info.

Bearing Dimensions

Basic Bearing Number	A Bore Diameter		B Outside Diameter		C Bearing Width		D		E		F	G	H	J	R	r		
	mm	in	mm	in	mm	in	Plain	Ribbed	Plain	Ribbed								
1918	90.0000	3.5433	125.0000	4.9213	18.0000	0.7087	97.00	99.60	118.60	115.60	102.77	112.92	99.568	115.636	1.52	1.02		
1018			140.0000	5.5118	24.0000	0.9449	99.60	102.40	131.60	127.80	107.42	122.71	102.362	127.775	2.54	1.52		
1218			160.0000	6.2992	30.0000	1.1811	103.10	107.20	147.60	142.00	114.17	135.89	107.218	142.189	3.18	2.03		
5218			52.3880	2.0625	43.0000	1.6929	108.20	113.80	172.70	165.40	124.33	156.16	114.031	165.047	3.96	2.54		
1318			190.0000	7.4803	54.0000	2.1260	73.0250	2.8750										
7318																		
5318																		
1919	95.0000	3.7402	130.0000	5.1181	18.0000	0.7087	102.10	104.40	123.70	120.40	107.72	117.40	104.521	120.589	1.52	1.02		
1019			145.0000	5.7087	24.0000	0.9449	104.40	107.20	136.60	132.60	112.40	127.68	107.340	132.756	2.54	1.52		
1219			170.0000	6.6929	32.0000	1.2598	109.00	113.30	157.00	151.10	121.03	144.48	113.518	151.242	3.18	2.03		
5219			55.5620	2.1875	45.0000	1.7717												
1319			200.0000	7.8740	56.0000	2.2047	115.10	121.90	181.90	173.50	132.46	164.29	122.154	173.530	3.96	2.54		
7319																		
5319																		
1920	100.0000	3.9370	140.0000	5.5118	20.0000	0.7874	107.20	110.00	133.40	129.50	113.92	125.81	109.995	129.738	1.52	1.02		
1020			150.0000	5.9055	24.0000	0.9449	109.50	112.30	141.70	137.70	117.52	132.59	112.344	137.759	2.54	1.52		
1220			180.0000	7.0866	34.0000	1.3386	116.10	120.90	167.10	161.00	128.45	154.18	121.006	161.216	3.96	2.03		
5220			60.3250	2.3750	47.0000	1.8504												
1320			215.0000	8.4646	60.0000	2.3622	122.40	130.00	194.60	184.60	140.46	175.06	130.165	184.907	4.75	2.54		
7320																		
5320																		

Additional Notes

Please call 1-866-REXNORD for availability
 Dimensions "R" & "r", largest fillet radius that will clear bearing corners
 Selection Guide, see Link-Belt Cylindrical Roller Bearing Selection Guide section
 Load Ratings & Speed Limits, see Link-Belt Cylindrical Roller Bearing Load Ratings & Speed Limits section
 For shaft and housing bearing seat diameters, see Link-Belt Cylindrical Bearing Shaft & Housing Seat Diameters section

Note: Dimensions subject to change. Certified dimensions of ordered material furnished on request.

105mm, 110mm, 120mm Bores

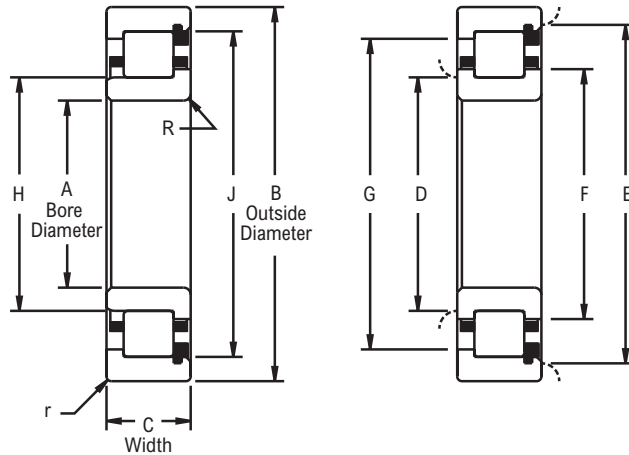

Photo Shows an Unmounted Cylindrical Roller Bearing Assembly

Product Features

- Fully crowned rollers
- Precision ground ribs
- Contoured roller pockets
- Rollers individually separated
- Optional full complement
- See Features & Benefits for additional info.

Bearing Drawing



Bearing Dimensions

Basic Bearing Number	A Bore Diameter		B Outside Diameter		C Bearing Width		D		E		F	G	H	J	R	r											
	mm	in	mm	in	mm	in	Plain	Ribbed	Plain	Ribbed																	
1921	105.0000	4.1339	145.0000	5.7087	20.0000	0.7874	112.00	114.80	138.20	134.60	118.92	130.81	114.996	134.739	1.52	1.02											
1021			160.0000	6.2992	26.0000	1.0236	115.80	119.10	150.10	145.80	124.48	140.61	119.151	145.941	2.54	2.03											
1221			190.0000	7.4803	36.0000	1.4173	121.40	126.50	175.30	168.40	134.87	161.01	126.520	168.562	3.96												
5221			65.0880	2.5625	49.0000	1.9291	128.00	136.10	203.40	193.30	147.17	183.16	136.185	193.456	4.75	2.54											
1321			63.0000	2.4803	87.3120	3.4375																					
7321			225.0000	8.8583	63.0000	2.4803	110.0000	4.3307	117.10	119.90	143.20	139.70	123.93	135.81	119.995	139.741	1.52	1.02									
5321	87.3120	3.4375	170.0000	6.6929	28.0000	1.1024													121.90	125.20	159.20	154.70	131.09	149.00	125.349	154.744	2.54
1922	150.0000	5.9055	20.0000	0.7874	127.20	132.80													183.90	176.00	141.60	168.43	132.951	176.192	3.96	2.03	
1022	170.0000	6.6929	38.0000	1.4961																							
1222	200.0000	7.8740	69.8500	2.7500	135.90	145.00													217.20	206.20	157.48	195.38	145.255	206.337	4.75	2.54	
5222	50.0000	1.9685	65.0000	2.5591																							
1322	92.0750	3.6250	240.0000	9.4488			129.80	131.30	157.70	153.90	135.97	149.50	131.498	153.985	2.03	1.02											
7322	65.0000	2.5591	76.2000	3.0000			132.10	135.10	169.20	164.60	141.22	158.90	135.357	164.754	3.18												
5322	92.0750	3.6250	215.0000	8.4646	139.20	145.00										198.90	190.80	154.30	182.73	145.138	190.952	4.75	2.03				
1924	120.0000	4.7244	165.0000	6.4961	22.0000	0.8661	147.80	157.00	135.20	223.00	170.18	211.20	157.023	223.053	6.35	2.54											
1024			180.0000	7.0866	28.0000	1.1024											40.0000	1.5748									
1224			215.0000	8.4646	76.2000	3.0000	171.00	176.00	203.40	193.30	147.17	183.16	136.185	193.456	4.75	2.54											
5224			55.0000	2.1654	71.0000	2.7953																					
1324			76.2000	3.0000	104.7750	4.1250																					
7324			260.0000	10.2362																							
5324	104.7750	4.1250																									

Additional Notes

Please call 1-866-REXNORD for availability
 Dimensions "R" & "r", largest fillet radius that will clear bearing corners
 Selection Guide, see Link-Belt Cylindrical Roller Bearing Selection Guide section
 Load Ratings & Speed Limits, see Link-Belt Cylindrical Roller Bearing Load Ratings & Speed Limits section
 For shaft and housing bearing seat diameters, see Link-Belt Cylindrical Bearing Shaft & Housing Seat Diameters section

Note: Dimensions subject to change. Certified dimensions of ordered material furnished on request.

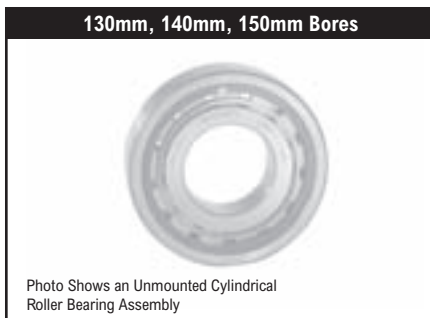

Product Features

- Fully crowned rollers
- Precision ground ribs
- Contoured roller pockets
- Rollers individually separated
- Optional full complement
- See Features & Benefits for additional info.

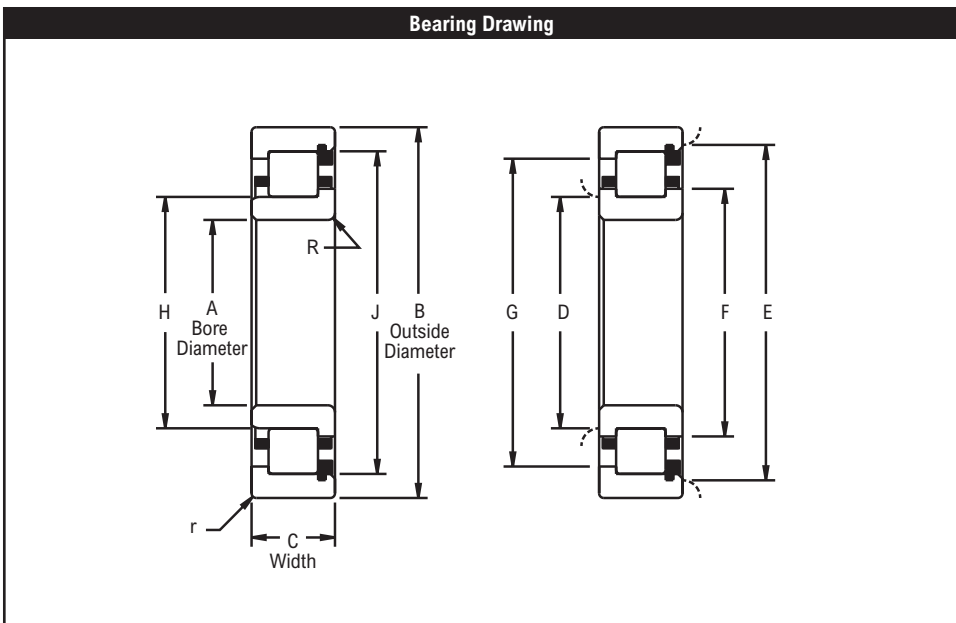

Bearing Dimensions

Basic Bearing Number	A Bore Diameter		B Outside Diameter		C Bearing Width		D		E		F	G	H	J	R	r		
	mm	in	mm	in	mm	in	Plain	Ribbed	Plain	Ribbed								
1926	130.0000	5.1181	180.0000	7.0866	24.0000	0.9449	139.20	142.20	171.70	167.60	147.42	162.99	142.367	167.085	2.03	1.52		
1026			200.0000	7.8740	33.0000	1.2992	143.00	147.60	188.20	182.40	154.56	175.59	147.574	182.570	3.18	2.03		
1226			230.0000	9.0551	40.0000	1.5748	149.10	154.90	213.90	206.20	164.72	197.13	154.973	206.375	4.75	2.54		
5226			79.3750	3.1250														
1326			280.0000	11.0236	58.0000	2.2835	160.30	170.40	254.50	242.60	184.91	229.77	170.536	242.755	6.35	3.18		
7326					75.0000	2.9528												
5326					111.1250	4.3750												
1928	190.0000	7.4803			24.0000	0.9449											149.10	152.40
1028	140.0000	5.5118	210.0000	8.2677	33.0000	1.2992	153.70	157.50	198.10	192.50	164.54	185.60	157.556	192.557	3.96	2.03		
1228			250.0000	9.8425	42.0000	1.6535	161.50	168.40	232.40	224.30	179.07	214.38	168.460	224.417	4.75	2.54		
5228			82.5500	3.2500														
1328			62.0000	2.4409	300.0000	11.8110	83.0000	3.2677	172.00	181.60	271.30	258.10	196.98	244.35	181.684	258.082	7.92	3.18
7328			83.0000	3.2677														
5328			114.3000	4.5000														
1930			150.0000	5.9055	210.0000	8.2677	28.0000	1.1024	161.50	165.40	199.10	194.60	171.22	188.92	165.354	194.790	3.18	2.03
1030	225.0000	8.8583			35.0000	1.3780	164.30	168.60	212.30	206.20	176.20	198.93	168.681	206.454	3.96			
1230	270.0000	10.6299			45.0000	1.7717	174.20	181.40	251.00	241.80	193.04	231.01	181.544	241.854	6.35	2.54		
5230	88.9000	3.5000																

Additional Notes

Please call 1-866-REXNORD for availability
 Dimensions "R" & "r", largest fillet radius that will clear bearing corners
 Selection Guide, see Link-Belt Cylindrical Roller Bearing Selection Guide section
 Load Ratings & Speed Limits, see Link-Belt Cylindrical Roller Bearing Load Ratings & Speed Limits section
 For shaft and housing bearing seat diameters, see Link-Belt Cylindrical Bearing Shaft & Housing Seat Diameters section

Note: Dimensions subject to change. Certified dimensions of ordered material furnished on request.

160mm, 170mm, 180mm, 190mm, 200mm Bores

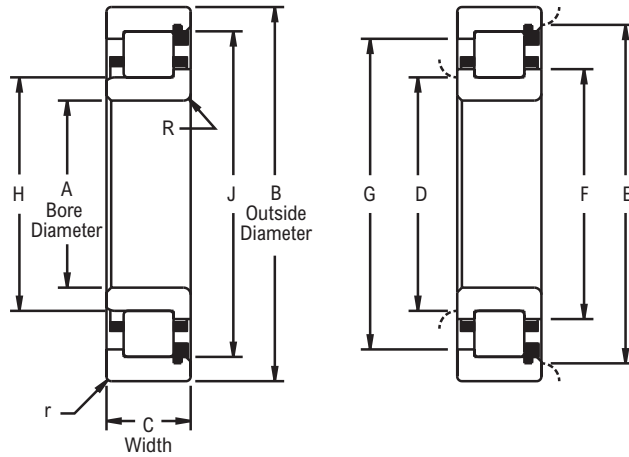

Photo Shows an Unmounted Cylindrical Roller Bearing Assembly

Product Features

- Fully crowned rollers
- Precision ground ribs
- Contoured roller pockets
- Rollers individually separated
- Optional full complement
- See Features & Benefits for additional info.

Bearing Drawing



Bearing Dimensions

Basic Bearing Number	A Bore Diameter		B Outside Diameter		C Bearing Width		D		E		F	G	H	J	R	r
	mm	in	mm	in	mm	in	Plain	Ribbed	Plain	Ribbed						
1932	160.0000	6.2992	220.0000	8.6614	28.0000	1.1024	171.70	175.30	209.30	204.70	181.25	198.96	175.387	204.828	3.18	2.03
1032			240.0000	9.4488	38.0000	1.4961	175.50	179.80	226.60	220.00	187.96	212.17	179.934	220.193	3.96	
1232			290.0000	11.4173	48.0000	1.8898	185.70	193.50	269.50	259.60	205.87	247.83	193.634	259.705	6.35	
5232			98.4250	3.8750												
1934	170.0000	6.6929	230.0000	9.0551	28.0000	1.1024	181.60	185.40	219.20	214.60	191.29	208.99	185.420	214.866	3.18	2.03
1034			260.0000	10.2362	42.0000	1.6535	188.20	193.30	244.10	236.50	202.31	227.81	193.421	236.710	4.75	
1234			310.0000	12.2047	52.0000	2.0472	197.10	205.20	287.50	277.60	219.08	264.74	205.483	277.734	6.35	
5234			104.7750	4.1250												
1936	180.0000	7.0866	250.0000	9.8425	33.0000	1.2992	193.00	197.60	238.20	232.40	204.60	225.68	197.612	232.644	3.96	2.03
1036			280.0000	11.0236	46.0000	1.8110	199.60	205.50	262.90	254.50	215.34	244.80	205.588	254.551	4.75	
1236			320.0000	12.5984	52.0000	2.0472	207.50	216.20	298.20	288.50	229.87	275.56	216.289	288.544	6.35	
5236			107.9500	4.2500												
1938	190.0000	7.4803	260.0000	10.2362	33.0000	1.2992	202.90	182.10	248.40	242.60	214.71	235.79	207.719	242.768	3.96	2.03
1038			290.0000	11.4173	46.0000	1.8110	209.60	215.40	272.80	264.40	225.93	254.23	215.595	264.576	4.75	
1238			340.0000	13.3858	55.0000	2.1654	220.10	229.10	320.37	309.63	244.11	290.48	229.276	309.723	7.42	
5238			114.3000	4.5000												
1940	200.0000	7.8740	280.0000	11.0236	38.0000	1.4961	215.40	220.00	266.40	260.10	227.99	252.22	219.964	260.256	4.75	2.03
1040			310.0000	12.2047	51.0000	2.0079	221.00	227.60	291.30	282.40	238.61	271.58	227.686	282.506	4.75	
1240			360.0000	14.1732	58.0000	2.2835	232.40	242.10	334.50	322.60	257.43	308.20	242.197	322.651	7.92	
5240			120.6500	4.7500												

Additional Notes

Please call 1-866-REXNORD for availability
 Dimensions "R" & "r", largest fillet radius that will clear bearing corners
 Selection Guide, see Link-Belt Cylindrical Roller Bearing Selection Guide section
 Load Ratings & Speed Limits, see Link-Belt Cylindrical Roller Bearing Load Ratings & Speed Limits section
 For shaft and housing bearing seat diameters, see Link-Belt Cylindrical Bearing Shaft & Housing Seat Diameters section

Note: Dimensions subject to change. Certified dimensions of ordered material furnished on request.

25mm thru 60mm Bores

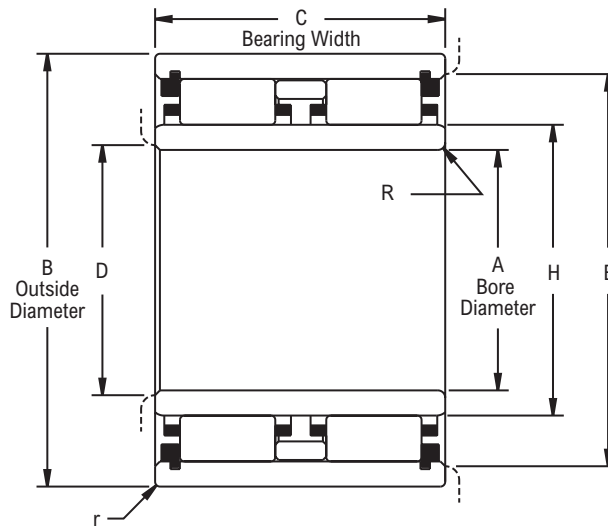

Photo Shows an Unmounted Cylindrical Roller Bearing Assembly

Product Features

- Double row
- Fully crowned rollers
- Contoured roller pockets
- Rollers individually separated
- See Features & Benefits for additional info.

Bearing Drawing



Bearing Dimensions

Basic Bearing Number	A Bore Diameter		B Outside Diameter		C Bearing Width		D	E	H	J O.R. Raceway I.D.	R	r	C Basic Load Rating	Co Basic Static Load Rating
	mm	in	mm	in	mm	in								
6205	25.0000	0.9843	52.0000	2.0472	41.2750	1.6250	30.50	47.00	32.166	44.854	1.02	1.02	10,200	15,700
6206	30.0000	1.1811	62.0000	2.4409	47.6250	1.8750	36.10	56.40	38.062	54.074	1.02	1.02	15,500	24,300
6207	35.0000	1.3780	72.0000	2.8346	53.9750	2.1250	41.60	65.30	43.970	62.471	1.02	1.02	19,400	30,600
6208	40.0000	1.5748	80.0000	3.1496	60.3250	2.3750	47.20	72.90	49.929	69.619	1.52	1.02	24,600	41,300
6209	45.0000	1.7717	85.0000	3.3465	60.3250	2.3750	52.80	78.20	55.519	74.988	1.52	1.02	26,700	47,500
6210	50.0000	1.9685	90.0000	3.5433	60.3250	2.3750	57.60	82.80	60.460	79.545	1.52	1.02	27,100	50,300
6211	55.0000	2.1654	100.0000	3.9370	66.6750	2.6250	64.00	87.90	66.901	88.019	2.03	1.52	32,900	61,900
6212	60.0000	2.3622	110.0000	4.3307	73.0250	2.8750	69.30	101.30	72.380	97.762	2.03	1.52	42,300	77,700

Additional Notes

Please call 1-866-REXNORD for availability
 Dimensions "R" & "r", largest fillet radius that will clear bearing corners
 Selection Guide, see Link-Belt Cylindrical Roller Bearing Selection Guide section
 For shaft and housing bearing seat diameters, see Link-Belt Cylindrical Bearing Shaft & Housing Seat Diameters section
 Note: Dimensions subject to change. Certified dimensions of ordered material furnished on request.

65mm thru 95mm Bores

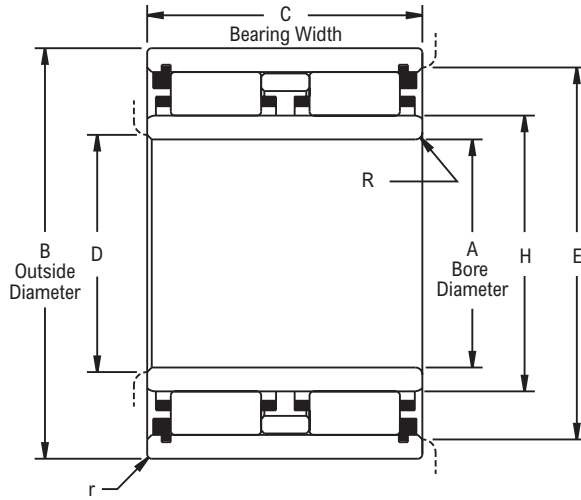

Photo Shows an Unmounted Cylindrical Roller Bearing Assembly

Product Features

- Double row
- Fully crowned rollers
- Contoured roller pockets
- Rollers individually separated
- See Features & Benefits for additional info.

Bearing Drawing



Bearing Dimensions

Basic Bearing Number	A Bore Diameter		B Outside Diameter		C Bearing Width		D	E	H	J O.R. Raceway I.D.	R	r	C Basic Load Rating	Co Basic Static Load Rating
	mm	in	mm	in	mm	in								
6213	65.0000	2.5591	120.0000	4.7244	76.2000	3.0000	77.00	110.00	80.421	105.804	2.54	1.52	45,900	88,700
6214	70.0000	2.7559	125.0000	4.9213	79.3750	3.1250	81.80	115.60	84.772	111.536	2.54	1.52	51,300	100,000
6215	75.0000	2.9528	130.0000	5.1181	82.5500	3.2500	85.60	120.10	89.014	115.781	2.54	1.52	55,800	113,000
6216	80.0000	3.1496	140.0000	5.5118	88.9000	3.5000	91.20	129.30	95.286	124.658	2.54	2.03	63,100	127,000
6217	85.0000	3.3465	150.0000	5.9055	98.4250	3.8750	98.00	101.80	102.006	134.216	3.18	2.03	77,600	159,000
6218	90.0000	3.5433	160.0000	6.2992	104.7750	4.1250	103.10	147.60	107.218	142.189	3.18	2.03	87,400	178,000
6219	95.0000	3.7402	170.0000	6.6929	111.1250	4.3750	109.00	157.00	113.518	151.242	3.18	2.03	100,000	206,000

Additional Notes

Please call 1-866-REXNORD for availability
 Dimensions "R" & "r", largest fillet radius that will clear bearing corners
 Selection Guide, see Link-Belt Cylindrical Roller Bearing Selection Guide section
 For shaft and housing bearing seat diameters, see Link-Belt Cylindrical Bearing Shaft & Housing Seat Diameters section
 Note: Dimensions subject to change. Certified dimensions of ordered material furnished on request.

World Class Customer Service

For more than 100 years, the dedicated people of Rexnord have delivered excellence in quality and service to our customers around the globe. Rexnord is a trusted name when it comes to providing skillfully engineered products that improve productivity and efficiency for industrial applications worldwide. We are committed to exceeding customer expectations in every area of our business: product design, application engineering, operations, and customer service.

Because of our customer focus, we are able to thoroughly understand the needs of your business and have the resources available to work closely with you to reduce maintenance costs, eliminate redundant inventories and prevent equipment down time.

Rexnord represents the most comprehensive portfolio of power transmission and conveying components in the world with the brands you know and trust.

WORLDWIDE CUSTOMER SERVICE

AUSTRALIA

Rexnord Australia Pty. Ltd.
Picton, New South Wales
Phone: 61-2-4677-3811
Fax: 61-2-4677-3812

Falk-Rexnord Australia Pty. Ltd.
Broadmeadow New South Wales
Phone: 61-2-4962-8000
Fax: 61-2-4962-8001

BRAZIL

Rexnord Correntes Ltda.
Sao Leopoldo - RS
Phone: 55-51-579-8022
Fax: 55-51-579-8029

CANADA

Rexnord Canada Ltd.
Scarborough, Ontario
Phone: 1-416-297-6868
Fax: 1-416-297-6873

CHINA

Rexnord China
Shanghai, China
Phone: 86-21-62701942
Fax: 86-21-62701943

EUROPE

Rexnord NV/SA
Mechelen, Belgium
Phone: 32-15-443881
Fax: 32-15-443860

LATIN AMERICA

Rexnord International, Inc
Milwaukee, Wisconsin
Phone: 1-414-643-2366
Fax: 1-414-643-2525
E-mail: international1@rexnord.com

MEXICO

Mecanica Falk, S. A. de C. V.
Mexico DF, Mexico
Phone: 52-55-9140-3500
Fax: 52-55-9140-3550

SINGAPORE

Rexnord International, Inc
Singapore City, Singapore
Phone: 65-6338-5622
Fax: 65-6338-5422

UNITED STATES

Customer Service
Phone: 866-Rexnord
(866-739-6673)
E-mail: CustSvc-EastCentral@Rexnord.com
CustSvc-MidAtlantic@Rexnord.com,
CustSvc-NorthEast@Rexnord.com,
CustSvc-SouthEast@Rexnord.com,
CustSvc-SouthWest@Rexnord.com,
CustSvc-WestCentral@Rexnord.com

ALL COUNTRIES NOT LISTED ABOVE

Rexnord International, Inc
Milwaukee, Wisconsin
Phone: 1-414-643-2366
Fax: 1-414-643-2525
E-mail: international1@rexnord.com

