



Anwendungsbereich

Schwerindustrie

Application

Heavy Industry





Das Unternehmen	The Company	6
Produktspektrum	Product Range	8
Rillenkugellager	Deep Groove Ball Bearings	8
Schrägkugellager	Angular Contact Ball Bearings	8
Vierpunktlager	Four Point Contact Ball Bearings	9
Zylinderrollenlager	Cylindrical Roller Bearings	9
Zylinderrollenlager, Bolzenkäfig	Cylindrical Roller Bearings, Steel Pin Cage	9
Axial-Zylinderrollenlager	Cylindrical Roller Thrust Bearings	10
Pendelrollenlager	Spherical Roller Bearings, Double Row	10
Axial-Pendelrollenlager	Spherical Roller Thrust Bearings	10
Kegelrollenlager	Tapered Roller Bearings	11
Schwerindustrie	Heavy Industry	12
Schaufelradbagger	Bucket Wheel Excavators	12
Bohrgeräte	Drills	13
Pumpen	Pumps	13
Rohrmühlen	Tube Mills	14
Förderanlagen/Transportsysteme	Conveyors/Transportation Systems	14
Brecher	Crushers	15
Schwingsiebe	Shaking Screens	15
Vertikalmühlen	Vertical Mills	15
Rollenpressen	Roller Presses	15
Drehrohröfen	Rotary Tube Kilns	16
Konverter	Converters	16
Stranggießanlagen	Continuous Casting Lines	16
Profilstraßen	Section Mills	16
Kaltwalzstraßen	Cold Rolling Mills	17
Drahtstraßen	Wire Rod Mills	17
Lieferprogramm	Delivery Program	18
Rillenkugellager	Deep Groove Ball Bearings	19
Schrägkugellager, einreihig	Angular Contact Ball Bearings, Single Row	24
Schrägkugellager, zweireihig	Angular Contact Ball Bearings, Double Row	30
Vierpunktlager	Four Point Contact Ball Bearings	32
Bauformen der Zylinderrollenlager	Design versions of cylindrical roller bearings	36
Zylinderrollenlager, einreihig	Cylindrical Roller Bearings, Single Row	37
Zylinderrollenlager in Zollabmessungen	Cylindrical Roller Bearings In Inch Size	54
Zylinderrollenlager, zweireihig	Cylindrical Roller Bearings, Double Row	56
Zylinderrollenlager, mehrreihig	Cylindrical Roller Bearings, Multi Row	58
Zylinderrollenlager, mehrreihig, Bolzenkäfig	Cylindrical Roller Bearings, Multi Row, Steel Pin Cage	59
Zylinderrollenlager (vollrollig), einreihig	Cylindrical Roller Bearings (Full Complement), Single Row	60

Zylinderrollenlager (vollrollig), zweireihig	Cylindrical Roller Bearings (Full Complement), Double Row	64
Zylinderrollenlager (vollrollig), mehrreihig	Cylindrical Roller Bearings (Full Complement), Multi Row	78
Axial-Zylinderrollenlager	Cylindrical Roller Thrust Bearings	82
Kegelrollenlager	Tapered Roller Bearings	90
Pendelrollenlager	Spherical Roller Bearings, Double Row	94
Axial-Pendelrollenlager	Spherical Roller Thrust Bearings	106
Technische Beratung	Technical Consulting	110
Nachsetzzeichen	Suffixes	112
Kontakt	Contact	116
Impressum	Imprint	118





Das Unternehmen

Die Kugel- und Rollenlagerwerk Leipzig GmbH ging aus dem Firmenverbund „Deutsche Kugellagerfabriken GmbH“ (DKF) hervor und führt heute die Entwicklung, Herstellung sowie den weltweiten Vertrieb von Wälzlagern unter der Markenbezeichnung „KRW“ mit dem Qualitätsmerkmal „Made in Germany“ fort.

Mit einer über 100-jährigen Ingenieurserfahrung, hochqualifizierten Mitarbeitern, einer innovativen Forschungs- und Entwicklungsabteilung sowie modernen Produktionstechniken erreicht die KRW Leipzig GmbH eine außerordentlich hohe Qualität bei Wälzlagerprodukten. Durch die konsequente Umsetzung eines stringenten Qualitätsmanagements erfüllt KRW fortwährend die Kriterien zur Erlangung der DIN EN ISO 9001-Zertifizierung, die vom TÜV als unabhängige Prüfstelle vergeben wird.

Der vorliegende Produktkatalog enthält nochmals verbesserte Standard-Produkte und zahlreiche Neuheiten in den verschiedensten Lagerbaureihen. Besonderes Augenmerk legt KRW neben der Fertigung von Standardlagern auf die kundenspezifische Sonderlagerentwicklung. Aktuell sind über 20 Prozent der produzierten Lager Sonderkonstruktionen.

Das KRW-Produktportfolio gliedert sich wie folgt:

- Rillenkugellager
- Schrägkugellager, einreihig, zweireihig
- Vierpunktlager
- Axial-Schrägkugellager
- Zylinderrollenlager, einreihig, mehrreihig
- Zylinderrollenlager (vollrollig), einreihig, mehrreihig
- Axial-Zylinderrollenlager
- Kegelrollenlager
- Tonnenrollenlager
- Pendelrollenlager
- Axial-Pendelrollenlager
- Sonderlager
- Lagerkomponenten und Zubehör

(Außendurchmesserbereich D = 125 mm bis 1300 mm entsprechend den DIN- bzw. DIN ISO-Normen).





The Company

Kugel- und Rollenlagerwerk Leipzig GmbH is evolved from the company group "Deutsche Kugellagerfabriken GmbH" (DKF) and continues the development, production and the worldwide distribution of roller bearings under the brand name "KRW" with the seal of quality "Made in Germany".

With over 100 years of engineering experience, highly skilled employees, an innovative research and development department as well as modern production techniques KRW Leipzig GmbH reaches extremely valuable bearing products. By a consistent implementation of a stringent quality management KRW continually meets the criteria for obtaining the DIN EN ISO 9001 certification, which is awarded by TÜV as an independent inspecting authority.

Also, the present catalogue contains improved standard products and many innovations in various bearing series. Besides the production of standard bearings KRW pays particular attention to the development of customer-specific bearing solutions. Currently more than 20 percent of the produced bearings are special constructions.

The KRW product portfolio covers:

- Deep groove ball bearings
- Angular contact ball bearings, single row, double row
- Four Point Contact Ball Bearings
- Angular contact thrust ball bearings
- Cylindrical roller bearings, single row, multi row
- Cylindrical roller bearings (full complement), single or multi row
- Cylindrical roller bearings in inch size
- Cylindrical roller thrust bearings
- Tapered roller bearings
- Spherical roller bearings, single row
- Spherical roller bearings, multi row
- Special bearings
- Components and accessories

(Outer diameter range OD = 125 mm to 1300 mm, in accordance with DIN and ISO standards).





Mit der Produktion von Standardlagern fertigt KRW eine Vielzahl von Wälzlagerprodukten für unzählige industrielle Anwendungen. In zunehmendem Umfang übernimmt KRW auch die Fertigung von Sonderlagern. Sonderbauformen sind vor allem dann erforderlich, wenn bestimmte Einsatzbedingungen besondere Eigenschaften des Wälzlagers verlangen. Die Sonderlager werden auf das jeweilige, spezielle Anforderungsprofil ausgelegt und in Deutschland produziert. Im nachfolgenden Produktspektrum werden die gängigsten Lagerbaureihen aus den Anwendungsbereichen Bergbau, Aufbereitung, Metallherstellung sowie Metallumformung mit ihren spezifischen Merkmalen vorgestellt.

KRW manufactures a wide range of standard bearings for countless industrial uses. Increasingly KRW also produces special application bearings. Such customized executions are needed when operation conditions require special characteristics of the bearings. These special executions are designed in order to meet these customer requirements and are manufactured in Germany. The product range introduced below covers the most common bearing types in the field of mining, processing, metal production as well as metal forming, and presents their special characteristics.

Rillenkugellager

Rillenkugellager nehmen sowohl radiale als auch axiale Kräfte auf und gehören zur weltweit häufigsten Lagerbauart. Auf Grund der geringen Winkeleinstellbarkeit müssen die Lagerstellen sehr gut fluchten. Rillenkugellager finden vielseitige Anwendung und werden primär bei Maschinen mit hohen Drehzahlen eingesetzt. Diese Lagerbauart ist preisgünstig und zuverlässig.

Deep Groove Ball Bearings

Deep groove ball bearings take up radial and axial forces. They are among the most used bearing types. Due to their limited capability of angular alignment, the bearings must be aligned accurately. They are used in many applications, primarily in machines that operate at high speeds. Deep groove ball bearings are competitively priced and very reliable.



Schrägkugellager

Je nach Typ und dem realisierten Druckwinkel verfügen Schrägkugellager über eine hohe axiale Belastungsfähigkeit in nur eine Richtung. Besonders im vorgespannten Zustand werden eine hohe Steifigkeit und eine gute Führungsgenauigkeit erreicht. Die einreihigen Schrägkugellager werden meist paarweise in X- oder O-Anordnung eingebaut.

Angular Contact Ball Bearings

Depending on their type and contact angle, angular contact ball bearings can sustain high axial loads in one direction only. Especially preloaded bearings have a high rigidity and a good guiding accuracy. Single row angular contact ball bearings are usually mounted in pairs (in X or O arrangements).



Vierpunktlager

Vierpunktlager gehören zu den einreihigen Schrägkugellagern; diese Lagerbauart ermöglicht, dass Kugellager Axialkräfte aus beiden Richtungen aufnehmen können. In der Ausführung Q haben sie einen geteilten Außenring und in der Ausführung QJ einen geteilten Innenring. Dadurch sind sowohl hohe Belastbarkeit als auch gute Montierbarkeit gegeben.

Four Point Contact Ball Bearings

Four Point Contact Ball Bearings are a subgroup of single row angular contact ball bearings which absorb axial loads in both directions. Four Point Contact Ball Bearings version Q have a divided outer ring. Four Point Contact Ball Bearings version QJ have a divided inner ring. This concept ensures both high ruggedness and easy installation.



Zylinderrollenlager

Die Grundform ist das ein-, zwei- oder mehrreihige Zylinderrollenlager. Gegenüber einem vergleichbaren Rillenkugellager ist ein Zylinderrollenlager bis zu 60% höher belastbar. Darüber hinaus verfügen Zylinderrollenlager in den verschiedensten Baureihen über ein hohes Variationspotenzial, ohne dabei in der radialen Belastungsfähigkeit eingeschränkt zu sein. Einzelne Baureihen können zudem auch einseitige Axialkräfte aufnehmen. Ein großer Vorteil dieses Lagertyps ist dessen einfache Zerlegbarkeit.

Cylindrical Roller Bearings

The basic forms are single row, double row and multi row cylindrical roller bearings. A cylindrical roller bearing can sustain up to 60% higher loads than a deep groove ball bearing. In addition, cylindrical roller bearings of various series can be produced in a practically unlimited number of variations without being limited in their radial load carrying capacity. Furthermore, bearings of some series can also take up axial forces from one direction. A big advantage offered by this type of bearings is that they can be disassembled with ease.



Zylinderrollenlager, Bolzenkäfig

Da Zylinderrollenlager hohen Belastungen standhalten müssen, werden sie oftmals mit Bolzenkäfigen aus Stahl ausgerüstet. Als Wälzkörper werden Hohlrollen verwendet, welche über die Käfigbolzen geführt werden. Diese Lager eignen sich somit für sehr hohe radiale Belastungen und können ein-, zwei- oder mehrreihig ausgeführt werden.

Cylindrical Roller Bearings, Steel Pin Cage

Cylindrical roller bearings, which have to endure high loads, often feature pin type steel cages. Hollow rollers which are guided over the cage pins serve as rolling elements. They are available as single-, double- or multi-row bearings.



Axial-Zylinderrollenlager

Axial-Zylinderrollenlager benötigen bauartbedingt nur wenig Platz und können besonders große Axialkräfte aufnehmen. Im typischen Anwendungsbereich herrschen verhältnismäßig geringe Drehzahlen. Geometrisch bedingt treten zwischen Laufbahn und Wälzkörpern hohe Schlupfkräfte auf, die durch angemessene Schmierung reduziert werden können. Axial-Zylinderrollenlager sind zerlegbar und somit sehr montagefreundlich.

Cylindrical Roller Thrust Bearings

Due to their design, cylindrical roller thrust bearings use only little space and are able to take up high axial forces as well as impact loads. They are typically used at relatively low speeds. Due to the bearings' internal geometry, high slippage forces are produced between raceway and rollers, which can be reduced by appropriate lubrication. Thanks to their separability, cylindrical roller thrust bearings are easy to install.



Pendelrollenlager

KRW fertigt, neben Pendelrollenlagern mit festen oder schwimmenden Führungsborden, auch Pendelrollenlager ohne Führungsborde am Innenring. Pendelrollenlager sind auf Grund ihrer hohen Tragfähigkeit ideal für Anwendungsbereiche, in denen schwerste Belastungen auftreten. Durch die zusätzliche Aufnahmefähigkeit von beidseitigen Axialkräften bieten Pendelrollenlager hohe Winkelbeweglichkeit und erlauben Wellendurchbiegungen.

Spherical Roller Bearings, Double Row

Besides spherical roller bearings double row with predefined guiding lips or floating flanges, KRW manufactures spherical roller bearings without flanges on the inner ring. Because of their high load carrying capacity, spherical roller bearings, double row, are ideally suited for applications where extremely high loads have to be accommodated. Moreover, spherical roller bearings, double row can sustain axial forces in both directions, offering an excellent self aligning capability and are impervious to shaft deflections as well as misalignment of the bearing seats.



Axial-Pendelrollenlager

Axial-Pendelrollenlager sind einreihige und, durch ihre innere Konstruktion bedingt, winkelveränderbare Lager, die Schiefstellungen der Achse im Lager ausgleichen. Massive Wellen- und Gehäusescheiben sowie Käfige aus Stahl, Stahlblech oder Messing sorgen für ein Höchstmaß an Tragfähigkeit. Axial-Pendelrollenlager können außerdem radiale Kräfte aufnehmen und sind für höhere Drehzahlen geeignet.

Spherical Roller Thrust Bearings

Spherical roller thrust bearings are single row bearings which, due to their internal geometry, can adjust their angle to compensate shaft misalignments. Solid shaft washers and housing washers as well as steel, steel plate or brass cages ensure an excellent load capacity. Spherical roller thrust bearings are able to take up radial forces and are suitable for higher speeds.



Kegelrollenlager

In den Einsatzgebieten, in welchen Wälzlager hohen Tragzahlen und einer Kombination aus radialen und axialen Kräften ausgesetzt sind, kommen Kegelrollenlager zum Einsatz. Diese Lager werden hauptsächlich paarweise verbaut (X- oder O-Anordnung), um wechselnde axiale Belastungen aufzunehmen, ohne das Lager komplett zu entlasten. Kegelrollenlager sind ausschließlich für geringe Drehzahlen geeignet.

Tapered Roller Bearings

Tapered roller bearings are predominantly used in applications where high load rating is required and where they primarily have to sustain combined radial and axial loads. These bearings are usually installed in pairs (X or O arrangement) to prevent a total discharge of the bearing. Tapered roller bearings are suitable for limited speeds only.





Kugel- und Rollenlager übernehmen im Anwendungsbereich Schwerindustrie wichtige Lagerungsaufgaben und sind bei der Rohstoffgewinnung, im Hüttenwesen sowie bei der Metallumformung unverzichtbar. Qualitativ hochwertige Lager und Lagerkomponenten tragen in einer Vielzahl von technischen Anwendungen zu einem hohen Wirkungsgrad, langen Standzeiten und maximaler Effizienz der Maschinen bei.

In the scope of heavy industry ball and roller bearings take on important tasks and are essential for bearings in the field of raw materials extraction, metallurgy, as well as in metal forming. High-quality bearings and bearing components contribute a high efficiency, long life and maximum efficiency of machines in a variety of technical applications.

Schaufelradbagger

In diesen Rohstoffabbauern kommt eine Vielzahl von Lagertypen zum Einsatz. Die Lager der Schaufelradwelle sind hohen und stoßartigen Belastungen ausgesetzt. Außerdem muss mit Wellendurchbiegungen und Fluchtungsfehlern gerechnet werden, die mittels Lagern ausgeglichen werden müssen. Die Langlebigkeit der Lager minimiert Förderausfall durch Wartungs- oder Instandsetzungsarbeiten.

Bucket Wheel Excavators

Many different bearing types are used in these raw material extraction machines. The bearings that support the bucket wheel shaft are subjected to high loads and heavy shocks. Moreover, the bearings must be able to compensate for shaft deflections and angular misalignments. The bearings are designed for the longest possible service life to minimize disruptions for maintenance or repair work.



Bohrgeräte

Bei dieser Anwendung mit horizontaler, diagonaler oder vertikaler Vortriebsbewegung kommt es stets auf möglichst konstante Führung des Bohrers bzw. Bohrkopfes an. Hier verbaute Wälzlager halten hohen Schwingungsbelastungen, starken Stößen sowie dynamischen Kräften stand. Axial- und Radiallager finden in der Spindellagerausführung mit höchster Laufgenauigkeit Anwendung.

Drills

In the application of drilling with horizontal, diagonal or vertical propulsion, a constant guidance of the drill and the drill head is necessary. Rolling bearings for drills must withstand high vibratory stresses, heavy shock loads as well as dynamic forces. Axial and radial spindle bearings of very high running accuracy are used for this application.



Pumpen

In diesem Anwendungsbereich kommt es je nach Ausführung und Wirkungsweise der Pumpen zu einer differenzierten Wälzlagerverwendung. Das Spektrum der Lagerbelastungen reicht von rein axialen und radialen Kräften bis hin zu kombinierten Krafterwirkungen bei umlaufend radialen Beschleunigungen. Hier kommen größtenteils Standardlager und Sonderlager zum Einsatz, welche hohe Standzeiten garantieren.

Pumps

In this field of application, various rolling bearing types are used, depending on a specific pump's construction and principle of operation. The loads that have to be accommodated by the bearings range from exclusive axial and radial forces to effects of combined forces produced by circulating radial accelerations. There are often used standard bearings and special bearings which provide high durability.



Rohrmühlen

Horizontalmühlen werden zur Zerkleinerung von Mineralien, Erzen, Kohle oder Zementklinkern eingesetzt. Sie bearbeiten das Rohmaterial durch Schlag und Reibung bis hin zur Pulverisierung. Rohrmühlen können bis zu 20 m lang sein und arbeiten bei vergleichsweise niedrigen Drehzahlen. In Rohrmühlen verbaute Lager müssen Fluchtungsfehler erlauben und dauerhaft stetigen Vibrationen standhalten.

Tube Mills

Horizontal mills are used for the crushing of minerals, ores, coal and cement clinker. The raw material is pulverized by beating and grinding. Tube mills can have a length up to 20 meters and operate at relatively low speeds. That means the bearings used must accommodate misalignments and withstand the permanent vibration.



Picture: Polysius AG (Stahl-Zentrum)

Förderanlagen/Transportsysteme

Bei diesen meist aus mehreren Komponenten (z. B.: Antrieb & Förderkomponente) bestehenden Anlagen treten teilweise hohe Drehzahlen und stark schwankende Belastungen auf. Zudem sind die Lager für diesen Arbeitsraum bei der Rohstoffgewinnung häufig einem erhöhten Verunreinigungsgrad der unmittelbaren Umgebung ausgesetzt.

Conveyors/Transportation Systems

In these systems, which usually consist of several elements (e. g. drive train and conveyor belt), bearings often have to accommodate high speeds and greatly fluctuating loads. In addition, the rolling bearings for this work environment (mining) are often exposed to increased contamination and pollution levels in their immediate surroundings.



Brecher

Brecher sind Maschinen, die, unter Einwirkung hoher Drücke, die Korngröße von Rohstoffen verringern. Exzenterwelle und Brecherschwinge werden dabei mit starken Kräften belastet, welche von flexiblen Lagern mit hoher dynamischer Tragfähigkeit aufgenommen werden.

Crushers

Crushers are machines that reduce raw materials to smaller grain sizes by exerting high pressure. The eccentric shaft and the rocker bars are subjected to extremely high loads, which must be taken up by bearings that combine the greatest possible flexibility with high dynamic load carrying capacity.



Schwingsiebe

Schwingsiebe (Schüttelsiebe) dienen dem Klassieren von Schüttgütern und gehören zu den am stärksten beanspruchten Maschinen bei der Rohstoffgewinnung und Rohstoffweiterverarbeitung. Wälzlager mit speziellen Konstruktionsformen tragen in diesen Maschinen zur Minimierung des Verschleißes bei.

Shaking Screens

Shaking screens (vibrating screens) are used for grading bulk material and are among the most severely stressed machines in the area of raw material extraction and processing. Rolling bearings with special design shapes contribute to minimize wear in these machines.



Vertikalmühlen

Vertikalmühlen (auch Schüsselmühlen genannt) werden für den Mahlvorgang und die Bearbeitung eines Rohstoffs bis zur gewünschten Korngröße eingesetzt. Die Lager in diesen Anlagen müssen hohen Drehzahlen und wechselnden Kräfteinflüssen standhalten.

Vertical Mills

Vertical mills are used for the grinding and processing of a raw material to the desired grain size. The bearings used in these mills, which are also referred as bowl mill units, must be suitable for high speeds and the effects of changing forces.



Picture: Polysus AG (Stahl-Zentrum)

Rollenpressen

Die besonderen Betriebsbedingungen und Einbauverhältnisse bei Rollenpressen führen zu ganz speziellen Leistungsansprüchen an das Lagerungssystem. Neben höchstmöglicher radialer Tragkraft, müssen Stöße aufgenommen werden, um maximale Standzeiten zu garantieren.

Roller Presses

Due to special operating and mounting conditions, bearings for roller presses must meet stringent requirements. The bearings must not only feature the highest possible radial load carrying capacity but also accommodate shock loads to guarantee maximum service lives.



Drehrohröfen

Drehrohröfen sind kontinuierlich arbeitende Brennöfen mit Feuerung; sie dienen der thermischen Behandlung verschiedener Materialien. Diese, in Abständen auf Laufrollen abgestützten, Öfen sind oft über 150 Meter lang. Die verwendeten Laufrollen werden wiederum durch Pendelrollenlager gelagert.

Rotary Tube Kilns

Rotary tube kilns are fueled furnaces that are used for the pyroprocessing of many different materials in a continuous process. The kilns, which are supported in regularly spaced support rollers, have a length of about 150 meters. These support rollers in turn are supported in spherical roller bearings.



Konverter

Konverter werden mittels Traglager und Großrad gestützt. Diese Bauteile sorgen für die Beweglichkeit des Konverters und müssen hohen Belastungen bei einer sehr geringen Umdrehungszahl standhalten. Auf Grund des Einsatzes unter Extrembedingungen, wie Hitze und Schmutz, müssen diese Lager unter anderem über eine gute Abdichtung verfügen.

Converters

Trunnion bearings and bull gear bearings are the supporting units of converters. They must withstand a high load at a very low number of revolutions. Since they are used in extreme conditions like heat and dirt, these bearings must, among other things, be well sealed.



Picture: ArcelorMittal (Stahl-Zentrum)

Stranggießanlagen

In den Pfannendrehtürmen von Stranggießanlagen kommen idealerweise abgedichtete, mehrreihige Wälzlager zum Einsatz, welche hohen Temperaturen standhalten und minimale Winkeländerungen der Welle zulassen beziehungsweise ausgleichen.

Continuous Casting Lines

In the ladle turrets of continuous casting lines, sealed multirow bearings are used which withstand the high temperatures and compensate for minimal changes in the shaft angle.



Profilstraßen

In Profilstraßen kommen große Walzen zum Einsatz, in welchen das Vormaterial in eine vorbestimmte Form gewalzt wird. Höchste Kräfteinwirkungen, die innerhalb der Profilstraße auf das Werkstück und die Lagersitze wirken, erfordern hier die Anwendung von mehrreihigen Lagern. Typisch sind Kegelrollen- und Zylinderrollenlager in abgestimmter Ausführung.

Section Mills

In section mills are large rolls which form the ingoing material into a predefined shape. Extremely high forces act on both: the workpiece and the bearing seats. This requires the use of multi-row bearings to spread the pressure loads evenly. Typical bearings for this application are tapered roller bearings and cylindrical roller bearings of special designs.



Picture: SMS

Kaltwalzstraßen

Diesen Bereich durchlaufen Werkstücke, die eine weitere Querschnittsreduktion erfahren. Die Anordnung der Walzen erfolgt, je nach Aufgabe, in verschiedenen Variationen. In der Regel werden Walzwerkskomponenten mit mehrreihigen Lagern ausgestattet, um gleichmäßige Druckverteilung auf die Lager und homogene Einwirkung der Walzen auf das Walzgut zu erzielen.

Cold Rolling Mills

Cold rolling mills are used for reducing the cross sections of the workpieces that run through them. The arrangement of the rolls depends on the task in hand. The rolls are usually supported in multi-row bearings to ensure an even distribution of pressure on the bearings and homogeneous rolling of the workpieces.



Picture: ThyssenKrupp

Drahtstraßen

Während Stahl durch die Drahtstraße läuft, entstehen stoßartige Kräfte, welche ein zähes und zugleich hartes Gefüge der Lagerungsmaterialien erfordern. Das Walzgut passiert bei hohen Geschwindigkeiten von bis zu $120 \frac{m}{s}$. Dies erfordert einen Kompromiss der drehzahlseitigen Optimierung bei der Lagerauswahl.

Wire Rod Mills

When steel runs through a wire rod mill, hard shocks are produced. This means that the bearings installed in the mill must consist of materials that are both hard and tough. The rolling stock travels through the rolling mill at velocities of up to $120 \frac{m}{s}$. This requires an additional compromise regarding the rotation speed when selecting the bearings.



Picture: Saarstahl





Die KRW Leipzig GmbH beweist ein hohes Maß an Verantwortungsbewusstsein und unterstreicht dieses mit stetigen Investitionen in die Forschung und Entwicklung neuer, innovativer und zukunftsweisender Produkte.

Auf den folgenden Seiten finden Sie eine Reihe von Standardlagern, die unter Einhaltung der oben genannten Fertigungsvorschriften von der KRW Leipzig GmbH produziert und vertrieben werden.

Zusätzlich zu allen aufgeführten Wälzlagertypen bietet das KRW-Portfolio ein umfangreiches Sortiment an Sonderlagern, welche individuelle Lagerungslösungen ermöglichen, aber nicht in den Tabellen aufgeführt sind.

Sollten Sie spezielle Produktanfragen bezüglich einer Anwendung haben, zögern Sie nicht, mit uns in Kontakt zu treten.

KRW Leipzig GmbH proves this with a high level of responsibility and emphasizes that with continuous investments in research and development of new, innovative and advanced products.

On the following pages you will find a range of standard bearings, which are produced and distributed by KRW Leipzig GmbH in compliance with the manufacturing requirements mentioned above.

In addition to all listed types of bearings, the KRW portfolio offers a large assortment of special bearings which allow individual bearing solutions. The special bearings are not listed in the following tables.

If you have special product requests for an application, do not hesitate to contact us.



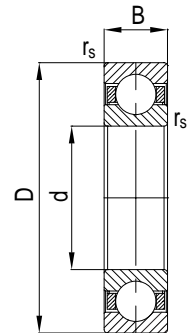
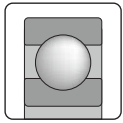

Rillenkugellager, einreihig Deep Groove Ball Bearings

618, 619, 160, 60, 62, 63, 64

Kurzzeichen	Abmessung				Tragzahl		Ermüdungs- grenzbel.	Grenz- drehzahl	Bezugs- drehzahl	Gewicht
					stat.	dyn.				
Code	Dimension				Load rating		Fatigue stress limit	Limiting speed	Reference speed	Weight
					stat.	dyn.				
	d mm	D mm	B mm	$r_{s\ min}$ mm	C_0 kN	C kN	C_u kN	n_g min ⁻¹	n_{th} min ⁻¹	kg
61916M	80	110	16	1	24	25	0,9	6300	5500	0,4
16016M	80	125	14	0,6	31	33	1,2	13000	4700	0,6
6016M	80	125	22	1,1	40	48	1,5	12000	5500	0,8
6216M	80	140	26	2	53	73	2	11000	5500	1,4
6316M	80	170	39	2,1	87	123	3,2	8900	5500	3,7
6416M	80	200	48	3	117	155	4,3	7500	5400	8,1
61917M	85	120	18	1,1	30	32	1,1	5700	5500	0,5
16017M	85	130	14	0,6	33	34	1,2	12000	4400	0,6
6017M	85	130	22	1,1	43	50	1,6	11000	5500	0,9
6217M	85	150	28	2	64	83	2,4	10000	5300	1,8
6317M	85	180	41	3	97	133	3,6	8000	5300	4,2
6417M	85	210	52	4	128	165	4,7	7000	5400	9,6
61918M	90	125	18	1,1	31	33	1,2	5400	5200	0,6
16018M	90	140	16	1	41	43	1,5	11000	4400	0,9
6018M	90	140	24	1,5	50	58	1,8	11000	5500	1,2
6218M	90	160	30	2	72	96	2,7	9000	5100	2,2
6318M	90	190	43	3	108	143	4	8000	5100	5,3
6418M	90	225	54	4	162	197	6	6700	4900	11,6
61919M	95	130	18	1,1	36	38	1,3	5200	4900	0,6
16019M	95	145	16	1	42	43	1,5	11000	4200	0,9
6019M	95	145	24	1,5	54	61	2	10000	5300	1,2
6219M	95	170	32	2,1	82	109	3	8500	5000	2,7
6319M	95	200	45	3	119	153	4,4	7500	4900	6,1
6419M	95	240	55	4	168	199	6,2	6300	4600	13,4
61920M	100	140	20	1,1	42	43	1,5	4800	4800	0,8
16020M	100	150	16	1	44	44	1,6	10000	4000	0,9
6020M	100	150	24	1,5	54	60	2	9500	5100	1,3
6220M	100	180	34	2,1	93	122	3,4	8000	4800	3,2
6320M	100	215	47	3	141	173	5,2	7000	4600	7,6
6420M	100	250	58	4	186	214	6,9	6000	4400	15,5
61921M	105	145	20	1,1	42	42	1,6	4600	4600	0,8
16021M	105	160	18	1	53	54	2	9500	4000	1,2
6021M	105	160	26	2	66	73	2,4	9000	5000	1,6
6221M	105	190	36	2,1	105	133	3,9	7500	4700	3,9
6321M	105	225	49	3	154	184	5,7	6700	4500	8,6
61822M	110	140	16	1	31	28	1,1	4800	4100	0,5
61922M	110	150	20	1,1	45	43	1,6	4500	4400	1
16022M	110	170	19	1	56	57	2,1	9000	3900	1,5
6022M	110	170	28	2	73	82	2,7	9000	4800	2
6222M	110	200	38	2,1	117	144	4,3	7000	4500	4,6
6322M	110	240	50	3	179	205	6,6	6300	4100	10,3
61824M	120	150	16	1	33	29	1,2	4500	3800	0,5

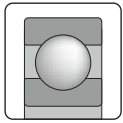

Rillenkugellager, einreihig
Deep Groove Ball Bearings

Kurzzeichen	Abmessung				Tragzahl		Ermüdungs- grenzbel.	Grenz- drehzahl	Bezugs- drehzahl	Gewicht
					stat.	dyn.				
Code	Dimension				Load rating		Fatigue stress limit	Limiting speed	Reference speed	Weight
					stat.	dyn.				
	d mm	D mm	B mm	r _{s min} mm	C ₀ kN	C kN	C _u kN	n _g min ⁻¹	n _{th} min ⁻¹	kg
61924M	120	165	22	1,1	57	55	2,1	4000	4100	1,1
16024M	120	180	19	1	64	61	2,4	8000	3500	1,6
6024M	120	180	28	2	79	85	2,9	8000	4500	2,1
6224M	120	215	40	2,1	118	145	4,4	6700	4300	5,6
6324M	120	260	55	3	185	207	5,5	6000	3800	12,8
61826M	130	165	18	1,1	43	38	1,6	4000	3600	0,8
61926M	130	180	24	1,5	67	65	2,5	3700	3900	1,8
16026M	130	200	22	1,1	82	79	3	7500	3400	2,4
6026M	130	200	33	2	101	106	3,7	7000	4400	3,3
6226M	130	230	40	3	132	155	4,9	6300	3900	6,2
6326M	130	280	58	4	215	229	6,4	5600	3500	18,2
61828M	140	175	18	1,1	46	39	1,7	3800	3300	0,8
61928M	140	190	24	1,5	71	67	2,6	3500	3700	1,6
16028M	140	210	22	1,1	82	78	3	7000	3200	2,5
6028M	140	210	33	2	102	105	3,8	6700	4100	3,5
6228M	140	250	42	3	150	166	5,5	6000	3600	8
6328M	140	300	62	4	233	242	6,9	5300	3300	22,1
61830M	150	190	20	1,1	57	49	2,1	3500	3200	1,1
61930M	150	210	28	2	90	85	3,3	3100	3600	3
16030M	150	225	24	1,1	95	87	3,5	6700	3100	3,1
6030M	150	225	35	2,1	118	121	4,4	6300	3900	4,3
6230M	150	270	45	3	168	176	5	5600	3400	10,3
6330M	150	320	65	4	284	274	8,4	4800	3000	26,6
61832M	160	200	20	1,1	61	51	2,3	3300	3000	1,2
01.16.01	160	200	20	1,1	61,325	55,9	2,3	3300	3000	1,2
61932M	160	220	28	2	96	87	3,5	3000	3400	3,2
16032M	160	240	25	1,5	105	94	3,9	6300	3000	4,3
6032M	160	240	38	2,1	135	137	5	6300	3800	6,3
6232M	160	290	48	3	186	185	5,5	5600	3100	14,3
6332M	160	340	68	4	290	275	8,6	4300	2800	31,5
61834M	170	215	22	1,1	73	61	2,7	3000	3000	1,6
61934M	170	230	28	2	100	89	3,7	2800	3200	2,9
16034M	170	260	28	1,5	126	114	3,7	6000	2900	5,1
6034M	170	260	42	2,1	160	161	4,8	5600	3600	8,4
6234M	170	310	52	4	223	213	6,6	5300	2900	17,7
6334M	170	360	72	4	364	327	10,8	4000	2600	37
61836M	180	225	22	1,1	76	62	2,8	2900	2800	1,7
61936M	180	250	33	2	126	114	4,7	2600	3200	4,2
16036M	180	280	31	2	156	140	4,6	5600	2800	7,7
6036M	180	280	46	2,1	184	180	5,5	5600	3400	11
6236M	180	320	52	4	241	228	7,1	4800	2800	18,3
6336M	180	380	75	4	408	354	12,1	3800	2400	43,3

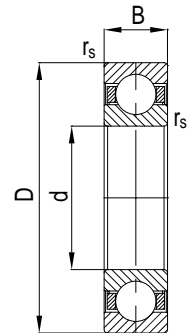

618, 619, 160, 60, 62, 63, 64

Kurzzeichen	Abmessung				Tragzahl		Ermüdungs- grenzbel.	Grenz- drehzahl	Bezugs- drehzahl	Gewicht
					stat.	dyn.				
Code	Dimension				Load rating		Fatigue stress limit	Limiting speed	Reference speed	Weight
					stat.	dyn.				
	d mm	D mm	B mm	$r_{s, min}$ mm	C_0 kN	C kN	C_u kN	n_g min ⁻¹	n_{th} min ⁻¹	kg
61838M	190	240	24	1,5	92	75	3,4	2700	2700	2,1
61938M	190	260	33	2	134	117	4	2500	3000	5,2
03.18.01	190	269,5	33	2	133,4	117,3	4	2500	3000	6,2
16038M	190	290	31	2	167	149	4,9	5300	2700	7,1
6038M	190	290	46	2,1	200	188	5,9	5300	3200	10,6
6238M	190	340	55	4	281	255	8,3	4300	2600	21,8
6338M	190	400	78	5	454	382	13,5	3600	2300	50
61840M	200	250	24	1,5	95	76	3,5	2600	2600	2,8
61940M	200	280	38	2,1	167	149	4,9	2300	2900	6,3
16040M	200	310	34	2	190	167	5,6	4800	2600	9,1
6040M	200	310	51	2,1	243	218	7,2	4800	3000	13,7
6240M	200	360	58	4	311	269	9,2	4000	2400	26,5
6340M	200	420	80	5	462	384	13,7	3400	2200	56,6
01.20.02	203,2	254	25,4	1,5	94,8	76,2	3,5	2600	2600	2,8
01.20.01	210	280	25	1,5	106	80,2	3,7	2500	2400	3,5
61844M	220	270	24	1,5	105	80	3,1	2400	2300	2,9
61944M	220	300	38	2,1	178	151	5,3	2200	2600	7,9
16044M	220	340	37	2,1	215	181	6,4	4300	2300	12
6044M	220	340	56	3	291	247	8,6	4000	2700	18
6244M	220	400	65	4	354	296	10,5	3600	2200	36,9
6344M	220	460	88	5	550	430	15,7	3200	2000	74,5
61848M	240	300	28	2	132	101	3,9	2200	2300	4,8
61948M	240	320	38	2,1	195	159	5,8	2000	2400	8,5
16048M	240	360	37	2,1	228	184	6,8	3800	2100	14,2
6048M	240	360	56	3	295	244	8,7	3800	2500	19,9
6248M	240	440	72	4	475	360	15,5	3400	2000	50,2
6348M	240	500	95	5	590	439	17,5	3000	1800	96
61852M	260	320	28	2	141	104	4,2	2000	2100	4,8
61952M	260	360	46	2,1	268	211	8	1800	2200	14,3
16052M	260	400	44	3	298	227	8,8	3600	2000	21,2
6052M	260	400	65	4	402	309	11,9	3400	2300	31,1
6252M	260	480	80	5	560	405	16	3000	1800	66,6
6352M	260	540	102	6	722	501	16,8	2700	1600	119
61856M	280	350	33	2	184	137	5,5	1800	2000	7,6
01.27.02	280	350	33	2	177	133	5,5	1800	2000	5,8
61956M	280	380	46	2,1	285	216	8,5	1700	2000	15,4
16056M	280	420	44	3	340	252	10,1	3400	1800	23,1
6056M	280	420	65	4	406	306	12	3400	2100	33
6256M	280	500	80	5	600	425	19,3	3000	1700	70
6356M	280	580	108	6	861	569	20,1	2500	1500	146
61860M	300	380	38	2,1	228	171	6,8	1700	1900	10,7
61960M	300	420	56	3	369	268	10,9	1500	1900	24,2

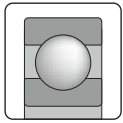

Rillenkugellager, einreihig
Deep Groove Ball Bearings

Kurzzeichen	Abmessung				Tragzahl		Ermüdungs- grenzbel.	Grenz- drehzahl	Bezugs- drehzahl	Gewicht
					stat.	dyn.				
Code	Dimension				Load rating		Fatigue stress limit	Limiting speed	Reference speed	Weight
					stat.	dyn.				
	d mm	D mm	B mm	r _{s min} mm	C ₀ kN	C kN	C ₀ kN	n _g min ⁻¹	n _{th} min ⁻¹	kg
16060M	300	460	50	4	414	295	12,3	3200	1700	32,7
6060M	300	460	74	4	510	360	15,9	3000	1900	43,2
6260M	300	540	85	5	668	456	15,6	2700	1600	89,7
61864M	320	400	38	2,1	245	177	7,3	1600	1700	11,3
61964M	320	440	56	3	394	276	11,7	1500	1800	25,5
16064M	320	480	50	4	444	304	13,2	3000	1600	34,4
6064M	320	480	74	4	550	375	17,8	3000	1800	49,4
6264M	320	580	92	5	853	567	19,9	2600	1400	111
61868M	340	420	38	2,1	253	179	7,5	1500	1600	11,9
61968M	340	460	56	3	418	283	12,4	1400	1600	26,9
16068M	340	520	57	4	525	348	12,2	2800	1500	47,3
6068M	340	520	82	5	695	440	15,4	2800	1700	61,4
6268M	340	620	92	6	954	602	22,3	2400	1300	128
10.35.01	350	415	25	2	148	85	4,2	1500	1500	6,6
61872M	360	440	38	2,1	261	181	7,7	1500	1500	12,6
61972M	360	480	56	3	438	289	13	1300	1500	28,2
16072M	360	540	57	4	585	365	13,1	2800	1400	49,6
6072M	360	540	82	5	735	455	17	2600	1600	64,4
61876M	380	480	46	2,1	366	244	10,9	1300	1400	20,7
61976M	380	520	65	4	534	336	12,5	1200	1500	40,7
16076M	380	560	57	4	620	375	13,6	2600	1300	50,6
6076M	380	560	82	5	720	455	16,9	2400	1500	71,3
61880M	400	500	46	2,1	379	248	11,3	1300	1300	21,6
61980M	400	540	65	4	561	344	13,1	1200	1400	42,5
16080M	400	600	63	5	629	378	14,7	2380	1200	68,3
6080M	400	600	90	5	858	527	20	2300	1400	87,2
61884M	420	520	46	2,1	393	251	9,2	1200	1300	22,8
61984M	420	560	65	4	586	352	13,7	1100	1300	46,1
01.41.01	420	580	70	4	1100	900	27,5	2200	1300	56
16084M	420	620	63	5	674	396	15,7	2260	1200	68,4
6084M	420	620	90	5	892	531	20,8	2200	1300	98,3
61888M	440	540	46	2,1	406	255	9,5	1200	1200	23,5
61988M	440	600	74	4	711	410	16,6	1100	1200	65,6
16088M	440	650	67	5	718	420	14,8	2160	1100	80,1
6088M	440	650	94	6	983	569	22,9	2100	1300	113
61892M	460	580	56	3	537	340	12,5	1100	1200	35,8
61992M	460	620	74	4	747	421	17,4	1000	1200	67,2
16092M	460	680	71	5	808	446	18,9	2060	1100	92,7
6092M	460	680	100	6	1083	609	25,2	2000	1200	131
61896M	480	600	56	3	556	325	13	1100	1100	38
61996M	480	650	78	5	809	447	18,9	1000	1100	78,4
6096M	480	700	100	6	1090	620	25,4	1900	1100	136

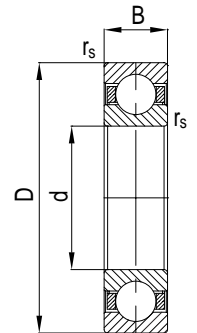

618, 619, 160, 60, 62, 63, 64

Kurzzeichen	Abmessung				Tragzahl		Ermüdungs- grenzbel.	Grenz- drehzahl	Bezugs- drehzahl	Gewicht
					stat.	dyn.				
Code	Dimension				Load rating		Fatigue stress limit	Limiting speed	Reference speed	Weight
					stat.	dyn.				
	d mm	D mm	B mm	$r_{s\ min}$ mm	C_0 kN	C kN	C_u kN	n_g min ⁻¹	n_{th} min ⁻¹	kg
618/500M	500	620	56	3	576	330	13,4	1000	1100	39,3
619/500M	500	670	78	5	848	459	19,8	900	1100	80
60/500M	500	720	100	6	1174	630	27,4	1900	1100	130
618/530M	530	650	56	3	616	341	14,4	1000	1000	38,5
619/530M	530	710	82	5	958	500	22,3	900	1000	96
60/530M	530	780	112	6	1388	711	24,9	1700	1000	183
618/560M	560	680	56	3	635	345	14,8	900	900	43,5
619/560M	560	750	85	5	1000	510	23,3	800	900	108
60/560M	560	820	115	6	1513	764	27,2	1600	1000	201
618/600M	600	730	60	3	713	371	16,6	900	900	50,5
619/600M	600	800	90	5	1174	569	21,1	800	900	132
60/600M	600	870	118	6	1546	751	27,8	1500	900	229
618/630M	630	780	69	4	883	441	15,9	800	800	60,5
619/630M	630	850	100	6	1324	626	23,8	700	800	168
60/630M	630	920	128	7,5	1660	880	27,1	1000	1200	284
618/670M	670	820	69	4	911	445	16,4	800	800	80,5
619/670M	670	900	103	6	1458	668	26,2	700	800	193
60/670M	670	980	136	7,5	2220	1000	30,4	900	1100	331
618/710M	710	870	74	4	1009	476	18,1	700	700	96,9
619/710M	710	950	106	6	1522	682	27,3	700	700	221
60/710M	710	1030	140	7,5	2040	1020	31,8	850	1000	380
618/750M	750	920	78	5	1191	540	21,4	700	700	115
619/750M	750	1000	112	6	1749	749	31,4	600	700	256
618/800M	800	980	82	5	1250	560	24,2	600	500	137
618/850M	850	1030	82	5	1385	592	24,9	600	500	145
618/900M	900	1090	85	5	1450	596	25,6	600	500	170
618/950M	950	1150	90	5	1547	632	27,8	500	500	195

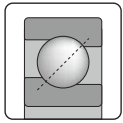

Schrägkugellager, einreihig
Angular Contact Ball Bearings, Single Row

Kurzzeichen	Abmessung						Tragzahl		Ermüdungs- grenzbel.	Grenz- drehzahl	Bezugs- drehzahl	Gewicht
							stat.	dyn.				
Code	Dimension						Load rating		Fatigue stress limit	Limiting speed	Reference speed	Weight
							stat.	dyn.				
	d mm	D mm	B mm	r _{s,min} mm	r _{1s,min} mm	a mm	C ₀ kN	C kN	C ₀ kN	n _g min ⁻¹	n _{th} min ⁻¹	kg
71816MP	80	100	10	0,6	0,3	31	19	15	0,3	5600	–	0,1
71916MP	80	110	16	1	0,6	35,4	31	29	0,6	5600	–	0,4
7016MP	80	125	22	1,1	0,6	40,6	53	58	2,4	5400	–	1
7216B.MPB	80	140	26	2	1	59,2	66	83	4	4800	5300	1,5
7316B.MPB	80	170	39	2,1	1,1	71,9	103	151	4,7	4560	4400	4,3
71817MP	85	110	13	1	0,6	34,6	26	22	0,5	5400	–	0,3
71917MP	85	120	18	1,1	0,6	38,6	41	38	0,8	5300	–	0,6
7017MP	85	130	22	1,1	0,6	42	56	59	2,6	5200	–	1,1
7217B.MPB	85	150	28	2	1	63,3	77	94	4,2	4500	5100	1,9
7317B.MPB	85	180	41	3	1,1	76,1	114	159	4,9	4290	4300	4,6
71818MP	90	115	13	1	0,6	36,1	27	23	0,5	5200	–	0,3
71918MP	90	125	18	1,1	0,6	40	42	39	0,8	5000	–	0,7
7018MP	90	140	24	1,5	1	45,2	66	70	3	4800	–	1,4
7218B.MPB	90	160	30	2	1	67,4	90	112	4,5	4200	4900	2,4
7318B.MPB	90	190	43	3	1,1	80,2	127	177	5,2	4060	4100	5,3
71819MP	95	120	13	1	0,6	37,5	29	23	0,5	5000	–	0,3
71919MP	95	130	18	1,1	0,6	41,5	47	43	0,9	4800	–	0,7
7019MP	95	145	24	1,5	1	46,6	70	72	3,2	4600	–	1,4
7219B.MPB	95	170	32	2,1	1,1	71,6	103	130	4,7	3900	4700	3,1
7319B.MPB	95	200	45	3	1,1	84,4	139	179	5,4	3840	3900	6,2
71820MP	100	125	13	1	0,6	39	30	24	0,5	4800	–	0,4
71920MP	100	140	20	1,1	0,6	44,6	54	49	1,1	4500	–	1
7020MP	100	150	24	1,5	1	48,1	74	73	3,4	4500	–	1,5
7220B.MPB	100	180	34	2,1	1,1	75,7	109	139	4,8	3700	4600	3,4
7320B.MPB	100	215	47	3	1,1	89,6	165	200	5,9	3560	3700	7,7
04.09.03	100	215	47	3	3	69	194	208	7	3560	3700	7,6
71821MP	105	130	13	1	0,6	40,4	31	24	0,5	4500	–	0,4
71921MP	105	145	20	1,1	0,6	46,1	56	50	1,1	4300	–	1
7021MP	105	160	26	2	1	51,2	84	85	3,1	4200	–	1,9
7221B.MPB	105	190	36	2,1	1,1	79,9	124	155	5,1	3500	4500	4,4
7321B.MPB	105	225	49	3	1,1	93,7	181	222	6,2	3400	3600	9,5
71822MP	110	140	16	1	0,6	44,1	41	33	0,7	4300	–	0,6
71922MP	110	150	20	1,1	0,6	47,5	58	51	1,1	4300	–	1
7022MP	110	170	28	2	1	54,4	95	97	3,5	3900	–	2,3
7222B.MPB	110	200	38	2,1	1,1	84	138	170	5,4	3300	4300	4,7
7322B.MPB	110	240	50	3	1,1	98,4	212	244	6,8	3170	3300	10,4
71824MP	120	150	16	1	0,6	47	44	34	0,8	4000	–	0,7
71924MP	120	165	22	1,1	0,6	52,1	75	64	1,5	3800	–	1,4
7024MP	120	180	28	2	1	57,3	110	100	4,1	3700	–	2,5
7224B.MPB	120	215	40	2,1	1,1	90,3	165	187	5,9	3000	4000	6,2
7324B.MPB	120	260	55	3	1,1	107,2	255	270	7,7	2920	3000	14,4
71826MP	130	165	18	1,1	0,6	51,6	57	44	1	3800	–	0,9

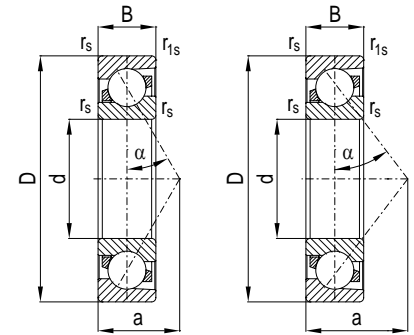
 70, 708, 709, 718, 719, $\alpha=30^\circ$

 72B, 73B, $\alpha=40^\circ$

Kurzzeichen	Abmessung						Tragzahl		Ermüdungs- grenzbel.	Grenz- drehzahl	Bezugs- drehzahl	Gewicht
							stat.	dyn.				
Code	Dimension						Load rating		Fatigue stress limit	Limiting speed	Reference speed	Weight
							stat.	dyn.				
	d mm	D mm	B mm	$r_{s, \min}$ mm	$r_{1s, \min}$ mm	a mm	C_0 kN	C kN	C_{10} kN	n_g min ⁻¹	n_{th} min ⁻¹	kg
71926MP	130	180	24	1,5	1	56,7	90	77	1,8	3600	–	1,8
7026MP	130	200	33	2	1	64,1	140	130	5,2	3300	–	3,8
7226B.MB	130	230	40	3	1,1	95,5	183	197	6,3	2800	3700	7
7326B.MB	130	280	58	4	1,5	115	273	284	8	2700	2700	17,5
71828MP	140	175	18	1,1	0,6	54,5	60	45	1,1	3600	–	1
71928MP	140	190	24	1,5	1	59,6	96	79	1,9	3400	–	2
7028MP	140	210	33	2	1	67	140	135	5,2	3100	–	4
12.14.04	140	210	33	2	1	77,8	138	127	4,7	3100	–	3,9
7228B.MPB	140	250	42	3	1,1	102,8	199	203	6,6	2600	3400	8,9
7328B.MPB	140	300	62	4	1,5	123,3	322	313	9	2520	2500	21,6
71830MP	150	190	20	1,1	0,6	59,1	76	58	1,4	3400	–	1,4
71930MP	150	210	28	2	1	66	121	100	2,4	3200	–	3
7030MP	150	225	35	2,1	1,1	71,6	170	150	6,3	2900	–	4,9
7230B.MPB	150	270	45	3	1,1	110,6	214	207	6,9	2400	3200	11,3
7330B.MPB	150	320	65	4	1,5	131,1	363	355	9,8	2350	2300	25,5
71832MP	160	200	20	1,1	0,6	62	80	59	1,4	3200	–	1,4
71932MP	160	220	28	2	1	68,8	125	101	2,4	3200	–	3,2
7032MP	160	240	38	2,1	1,1	76,7	190	170	7	2700	–	6,1
7232B.MPB	160	290	48	3	1,1	118,4	252	230	7,6	2200	3000	14
7332B.MPB	160	340	68	4	1,5	138,9	404	373	10,6	2210	2200	30,5
71834MP	170	215	22	1,1	0,6	66,6	98	72	1,8	3000	–	1,9
71934MP	170	230	28	2	1	71,7	133	104	2,6	3000	–	3,3
7034MP	170	260	42	2,1	1,1	83,1	230	195	8,5	2500	–	7,9
7234B.MPB	170	310	52	4	1,5	126,7	278	245	8,1	2100	2800	17,5
7334B.MPB	170	360	72	4	1,5	147,2	444	388	11,3	2090	2000	36,1
71836MP	180	225	22	1,1	0,6	69,5	103	73	1,8	2800	–	4,9
71936MP	180	250	33	2	1	78,6	169	134	3,3	2800	–	4,9
7036MP	180	280	46	2,1	1,1	119,5	265	220	8,9	2300	–	10,5
7236B.MPB	180	320	52	4	1,5	130,9	308	269	8,7	2000	2600	18
7336B.MPB	180	380	75	4	1,5	155	490	415	13,7	1990	1900	41,7
71838MP	190	240	24	1,5	1	74,1	119	136	2,1	2800	–	2,6
71938MP	190	260	33	2	1	81,5	174	128	3,4	2600	–	5,2
7038MP	190	290	46	2,1	1,1	92,3	290	230	10,7	2200	–	11
7238B.MPB	190	340	55	4	1,5	138,7	340	300	9,9	1900	2400	21,9
7338B.MPB	190	400	78	5	2	162,8	520	430	15	1890	1800	48,3
71840MP	200	250	24	1,5	1	77	125	88	2,2	2600	–	2,7
71940MP	200	280	38	2,1	1,1	88,3	218	171	4,2	2400	–	7,3
7040MP	200	310	51	2,1	1,1	99,1	320	255	11,9	2100	–	14,2
7240B.MPB	200	360	58	4	1,5	146,5	380	320	11	1800	2200	26,1
7340B.MPB	200	420	80	5	2	170,1	570	465	16,5	1790	1700	54,3
71844MP	220	270	24	1,5	1	82,7	137	92	2,5	2200	–	3
71944MP	220	300	38	2,1	1,1	94,1	232	176	4,5	2000	–	7,9

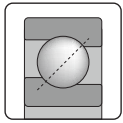

Schrägkugellager, einreihig
Angular Contact Ball Bearings, Single Row

Kurzzeichen	Abmessung						Tragzahl		Ermüdungs- grenzbel.	Grenz- drehzahl	Bezugs- drehzahl	Gewicht
							stat.	dyn.				
Code	Dimension						Load rating		Fatigue stress limit	Limiting speed	Reference speed	Weight
							stat.	dyn.				
	d mm	D mm	B mm	r _{s,min} mm	r _{1s,min} mm	a mm	C ₀ kN	C kN	C ₀ kN	n _g min ⁻¹	n _{th} min ⁻¹	kg
7044MP	220	340	56	3	1,1	108,8	390	285	14,4	1900	–	18,7
7244B.MPB	220	400	65	4	1,5	162,6	465	365	13,5	1700	2000	36,6
7344B.MPB	220	460	88	5	2	186,6	739	546	17,1	1620	1500	71,5
71848MP	240	300	28	2	1	91,9	176	118	3,2	2000	–	4,6
71948MP	240	320	38	2,1	1,1	99,8	254	184	4,9	1900	–	8,5
7048MP	240	360	56	3	1,1	114,6	430	300	15,9	1800	–	20,1
7248B.MP	240	440	72	4	1,5	178,7	585	440	17	1600	1800	49,4
7348B.MP	240	500	95	5	2	202,7	878	608	19,8	1490	1300	90,6
71852MP	260	320	28	2	1	97,7	187	121	3,4	1900	–	4,9
71952MP	260	360	46	2,1	1,1	112,5	362	249	7	1800	–	14,5
7052MP	260	400	65	4	1,5	127,8	560	365	16,6	1600	–	29,8
7252B.MPB	260	480	80	5	2	195,2	790	486	18,2	1500	1600	65,3
7352B.MPB	260	540	102	6	3	218,8	930	655	21,4	1380	1200	113
71856MP	280	350	33	2	1	107,4	240	157	4,3	1800	–	7,2
71956MP	280	380	46	2,1	1,1	118,3	385	257	7,5	1700	–	15,2
7056MP	280	420	65	4	1,5	133,5	590	375	17,5	1500	–	31,6
7256B.MPB	280	500	80	5	2	203,6	872	584	19,7	1300	1500	68,9
7356B.MPB	280	580	108	6	3	234,4	1126	705	24,6	1280	1100	140
71860MP	300	380	38	2,1	1,1	117,1	305	200	5,5	1700	–	10,5
71960MP	300	420	56	3	1,1	131,9	513	321	10	1600	–	24,2
7060MP	300	460	74	4	1,5	146,7	715	440	21,1	1400	–	44,9
7260B.MPB	300	540	85	5	2	218,7	958	616	21,4	1200	1400	87,1
71864MP	320	400	38	2,1	1,1	122,9	327	204	5,9	1600	–	11
71964MP	320	440	56	3	1,1	137,7	529	324	10,3	1500	–	25,6
7064MP	320	480	74	4	1,5	152,5	760	450	22,5	1300	–	47,1
71868MP	340	420	38	2,1	1,1	128,7	333	207	6	1500	–	11,7
71968MP	340	460	56	3	1,1	143,5	564	336	11	1500	–	26,7
7068MP	340	520	82	5	2	165,1	905	520	26,4	1200	–	63,5
71872MP	360	440	38	2,1	1,1	134,5	348	211	6,2	1500	–	12,2
71972MP	360	480	56	3	1,1	149,2	580	339	11,3	1400	–	28,2
7072MP	360	540	82	5	2	170,9	960	530	28,5	1200	–	66,5
71876MP	380	480	46	2,1	1,1	147,1	491	288	8,6	1300	–	19,8
71976MP	380	520	65	4	1,5	162,4	697	390	13,6	1200	–	40,8
03.37.01	380	520	65	2	1	–	700	390	15	1200	–	37,4
7076MP	380	560	82	5	2	176,7	1010	545	30	1100	–	69,4
71880MP	400	500	46	2,1	1,1	152,9	515	295	9	1200	–	20,8
71980MP	400	540	65	4	1,5	168,2	742	403	14,4	1200	–	30,1
7080MP	400	600	90	5	2	189,3	1180	615	34,4	1100	–	89,9
71884MP	420	520	46	2,1	1,1	158,7	540	301	9,4	1200	–	21,5
71984MP	420	560	65	4	1,5	174	763	408	14,9	1100	–	44,2
7084MP	420	620	90	5	2	195,1	1245	630	36,8	1000	–	93,4
71888MP	440	540	46	2,1	1,1	164,5	564	307	9,8	1100	–	22,5

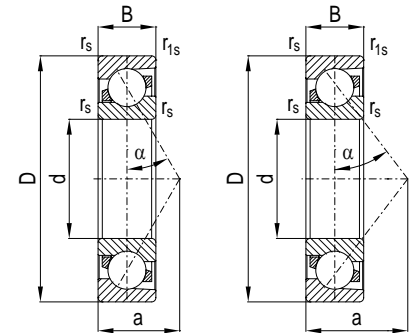
 70, 708, 709, 718, 719, $\alpha=30^\circ$

 72B, 73B, $\alpha=40^\circ$

Kurzzeichen	Abmessung						Tragzahl		Ermüdungs- grenzbel.	Grenz- drehzahl	Bezugs- drehzahl	Gewicht
							stat.	dyn.				
Code	Dimension						Load rating		Fatigue stress limit	Limiting speed	Reference speed	Weight
							stat.	dyn.				
	d mm	D mm	B mm	$r_{s, min}$ mm	$r_{1s, min}$ mm	a mm	C_0 kN	C kN	C_{90} kN	n_g min ⁻¹	n_{th} min ⁻¹	kg
71988MP	440	600	74	4	1,5	187,1	928	476	18,1	1000	–	62
7088MP	440	650	94	6	3	204,3	1375	675	40,6	1000	–	107
70892MP	460	580	37	2,1	1,1	168,6	431	247	12,8	1100	–	24,2
71892MP	460	580	56	3	1,1	178,1	698	368	12,5	1000	–	35
71992MP	460	620	74	4	1,5	192,9	988	493	19,2	950	–	64
7092MP	460	680	100	6	3	214,5	1515	725	44,8	900	–	125
70896MP	480	600	37	2,1	1,1	174,4	432	244	12,8	1100	–	25,3
71896MP	480	600	56	3	1,1	183,9	733	376	13,2	950	–	36
71996MP	480	650	78	5	2	202,1	1196	605	21,2	950	–	74,5
7096MP	480	700	100	6	3	220,3	1525	720	45,1	900	–	129
708/500MP	500	620	37	2,1	1,1	180,2	434	241	12,9	1000	–	26,2
718/500MP	500	620	56	3	1,1	189,7	786	390	14,1	950	–	37,5
03.50.01	500	660	65	2	1	–	740	375	13,9	910	–	57,5
719/500MP	500	670	78	5	2	207,9	1123	538	21,9	900	–	77
70/500MP	500	720	100	6	3	226,1	1600	735	47,1	900	–	134
708/530MP	530	650	37	2,1	1,1	188,8	447	241	1,4	1000	–	27,5
718/530MP	530	650	56	3	1,1	198,3	801	391	14,4	900	–	40
709/530MP	530	710	57	4	1,5	207,5	1070	470	25	900	–	66
719/530MP	530	710	82	5	2	220	1268	586	24,7	850	–	92
70/530MP	530	780	112	6	3	245,1	1980	875	45,9	800	–	188
708/560MP	560	680	37	2,1	1,1	197,5	457	240	1,7	900	–	29
03.55.01	560	680	42	2,1	1,1	200	540	270	–	–	–	28
718/560MP	560	680	56	3	1,1	207	835	398	15	850	–	42
709/560MP	560	750	60	5	2	219,1	1140	490	26,6	850	–	77
719/560MP	560	750	85	5	2	231,6	1343	633	26,1	800	–	105
70/560MP	560	820	115	6	3	256,7	2110	905	49,2	800	–	213
708/600MP	600	730	42	3	1,1	213	542	269	12,6	900	–	38
718/600MP	600	730	60	3	1,1	222	927	425	16,7	800	–	52
709/600MP	600	800	63	5	2	233,6	1250	530	22,5	800	–	92
719/600MP	600	800	90	5	2	247,1	1504	651	29,3	750	–	126
70/600MP	600	870	118	6	3	271,2	2420	980	56,4	700	–	241
03.70.01	610	790	80	2	1	–	1065	485	18,2	750	–	95
708/630MP	630	780	48	3	1,1	227,5	704	328	16,4	800	–	55
718/630MP	630	780	69	4	1,5	238	1100	530	20,9	750	–	76
03.67.01	630	810	90	2	1	–	2371	842	40,1	700	–	115
709/630MP	630	850	71	5	2	249,1	1450	590	26,1	750	–	125
719/630MP	630	850	100	6	3	263,6	1752	733	34,1	700	–	170
70/630MP	630	920	128	7,5	4	287,7	2680	1050	62,5	700	–	297
708/670MP	670	820	48	3	1,1	239,1	830	366	19,4	800	–	58
718/670MP	670	820	69	4	1,5	249,6	1212	540	21,8	700	–	80
709/670MP	670	900	73	5	2	263,1	1490	590	26,8	700	–	142
719/670MP	670	900	103	6	3	278,1	1992	799	38,8	670	–	194

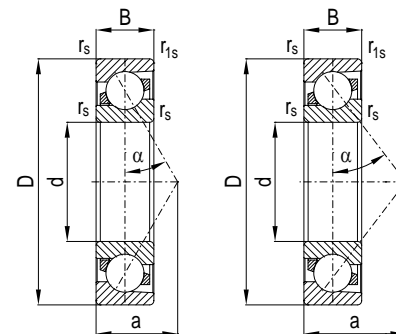
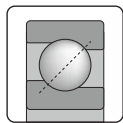

Schrägkugellager, einreihig
Angular Contact Ball Bearings, Single Row

70, 708, 709, 718, 719, $\alpha=30^\circ$

72B, 73B, $\alpha=40^\circ$

Kurzzeichen	Abmessung						Tragzahl		Ermüdungs- grenzbel.	Grenz- drehzahl	Bezugs- drehzahl	Gewicht
							stat.	dyn.				
Code	Dimension						Load rating		Fatigue stress limit	Limiting speed	Reference speed	Weight
							stat.	dyn.				
	d mm	D mm	B mm	$r_{s, min}$ mm	$r_{1s, min}$ mm	a mm	C_0 kN	C kN	C_u kN	n_g min ⁻¹	n_{th} min ⁻¹	kg
70/670MP	670	980	136	7,5	4	306,2	3030	1160	70,7	600	–	361
03.69.01	700	880	90	2	1	–	1484	608	23,9	670	–	121,6
708/710MP	710	870	50	4	1,5	253,1	919	396	21,4	700	–	69
718/710MP	710	870	74	4	1,5	265,1	1280	580	23,8	630	–	96
709/710MP	710	950	78	5	2	278,6	1880	710	33,8	670	–	168
719/710MP	710	950	106	6	3	292,6	2106	821	41	600	–	222
70/710MP	710	1030	140	7,5	4	321,1	3365	1250	78,1	600	–	402
708/750MP	750	920	54	4	1,5	268	955	399	22,3	700	–	84
718/750MP	750	920	78	5	2	280	1800	665	27,8	600	–	115
709/750MP	750	1000	80	6	3	292,6	1970	730	35,5	630	–	189
719/750MP	750	1000	112	6	3	308,6	2311	875	45	560	–	256
708/800MP	800	980	57	4	1,5	285,4	1070	431	19,2	600	–	100
718/800MP	800	980	82	5	2	297,9	1788	683	32,1	560	–	138
719/800	800	1060	115	6	3	325,6	2600	1040	50	530	–	290
708/850MP	850	1030	57	4	1,5	299,9	1092	428	19,6	600	–	106
03.84.02	850	1030	57	4	1,5	298,1	1200	400	21,9	600	–	105
718/850MP	850	1030	82	5	2	312,4	1861	693	33,4	530	–	145
719/850	850	1120	1180	6	3	343,3	2850	1100	55	500	–	328
719/900	900	1180	122	6	3	361,2	3100	1160	60	480	–	373



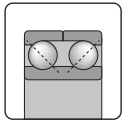

Schrägkugellager, zweireihig
Angular Contact Ball Bearings, Double Row

Kurzzeichen	Type	Abmessung										
Code	Type	Dimension										
		d mm	D mm	B mm	b mm	r mm	r ₁ mm	r ₂ mm	a ₁ mm	a ₂ mm	d ₁ mm	
SKZ90x125MB	39	90	125	26	2	2	0,8	–	–	–	–	
SKZ100x140MB	39	100	140	30	2	2	0,8	–	–	–	–	
SKZ110x150MB	39	110	150	30	3	2	0,8	–	–	–	–	
SKZ120x165MB	39	120	165	34	4	2	0,8	–	–	–	–	
SKZ130x180MB	39	130	180	37	4	2,5	0,8	–	–	–	–	
SKZ140x190MB	39	140	190	37	4	2,5	0,8	–	–	–	–	
SKZ150x210MB	39	150	210	45	4	3	1	–	–	–	–	
SKZ150x225MB	30	150	225	56	0	3,5	1,2	50	14	28	152	
SKZ160x220MB	39	160	220	45	4	3	1	–	–	–	–	
SKZ160x240MB	30	160	240	60	0	3,5	1,2	50	16	28	162	
SKZ170x230MB	39	170	230	45	4	3	1	–	–	–	–	
SKZ170x260MB	30	170	260	67	0	3,5	1,2	50	17,5	32	172,5	
SKZ180x250MB	39	180	250	52	4	3	1	–	–	–	–	
SKZ180x280MB	30	180	280	74	0	3,5	1,2	60	21	32	183	
SKZ190x260MB	39	190	260	52	4	3	1	–	–	–	–	
SKZ190x290MB	30	190	290	75	0	3,5	1,2	60	19,5	36	193	
SKZ200x280MB	39	200	280	60	4	3,5	1,2	–	–	–	–	
SKZ200x310MB	30	200	310	82	0	3,5	1,2	60	23	36	203,5	
SKZ220x300MB	39	220	300	60	4	3,5	1,2	–	–	–	–	
SKZ220x340MB	30	220	340	90	0	4	1,5	60	25	40	224	
SKZ240x320MB	39	240	320	60	4	3,5	1,2	–	–	–	–	
SKZ240x360MB	30	240	360	92	0	4	1,5	60	26	40	244	
SKZ260x360MB	39	260	360	75	4	3,5	1,2	–	–	–	–	
SKZ260x400MB	30	260	400	104	0	5	2	60	28	48	265	
SKZ280x380MB	39	280	380	75	4	3,5	1,2	–	–	–	–	
SKZ280x420MB	30	280	420	106	0	5	2	60	29	48	285	
SKZ300x420MB	39	300	420	90	4	4	1,5	–	–	–	–	
SKZ300x460MB	30	300	460	118	0	5	2	60	31	56	306	
SKZ320x480MB	30	320	480	121	0	5	2	80	32,5	56	326	

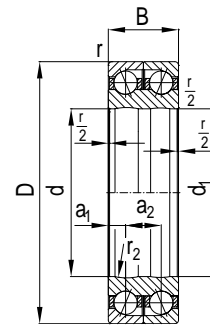

30

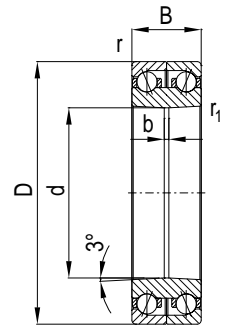

39

Tragzahl		Grenzdrehzahl		Gewicht
stat.	dyn.	Fett	Öl	
Load rating		Limiting speed		Weight
stat.	dyn.	Grease	Oil	
C_0 kN	C kN	rpm	rpm	kg
68	46	3100	3900	1,2
86	60	2750	3450	1,7
94	62	2550	3200	2,2
109	71	2300	2900	2,6
127	82	2100	2650	2,9
137	84	2000	2500	3,8
188	117	1800	2250	4,5
249	165	1650	2000	6,7
198	119	1700	2150	5,5
296	194	1550	1900	8,7
207	122	1600	2050	6,5
375	247	1450	1800	11,7
267	159	1500	1850	7,6
404	261	1350	1600	15,4
274	160	1450	1800	8,2
468	308	1300	1550	16,2
332	191	1350	1650	12
527	335	1200	1400	20,7
357	197	1250	1550	16
659	393	1100	1300	27,6
390	205	1150	1450	19
719	409	1000	1200	30
552	299	1050	1300	23
921	495	900	1050	43,8
578	305	950	1200	27
963	502	800	950	47,4
798	419	900	1100	36
1147	566	750	900	65,5
1227	588	800	1000	70,8

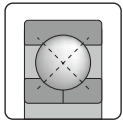

Vierpunktlager
Four Point Contact Ball Bearings

Kurzzeichen	Abmessung					Tragzahl		Ermüdungs- grenzbel.	Grenz- drehzahl	Bezugs- drehzahl	Gewicht
						stat.	dyn.				
Code	Dimension					Load rating		Fatigue stress limit	Limiting speed	Reference speed	Weight
						stat.	dyn.				
	d mm	D mm	B mm	r _{s min} mm	a mm	C ₀ kN	C kN	C _u kN	n _g min ⁻¹	n _{th} min ⁻¹	kg
QJ1016MPA	80	125	22	1,1	72	83	56	4	8800	5400	1,1
QJ216MPA	80	140	26	2	77	137	132	6	8000	4300	1,8
Q216MPB	80	140	26	2	47	150	146	7	8000	4100	1,8
QJ316MPA	80	170	39	2,1	88	210	224	10	7000	3800	4,6
Q316MPB	80	170	39	2,1	53	227	236	10	7000	3700	4,5
QJ1017MPA	85	130	22	1,1	75	102	62	5	8000	5000	1,1
QJ217MPA	85	150	28	2	82	159	151	7	7000	4100	2,3
Q217MPB	85	150	28	2	50	174	163	8	7000	3900	2,3
QJ317MPA	85	180	41	3	93	234	234	11	6300	3600	5,5
Q317MPB	85	180	41	3	56	253	254	12	6300	3500	5,3
QJ1018MPA	90	140	24	1,5	81	105	70	5	7800	4800	1,4
QJ218MPA	90	160	30	2	88	185	176	8	7000	3900	2,8
Q218MPB	90	160	30	2	53	202	193	9	7000	3700	2,8
QJ318MPA	90	190	43	3	98	284	270	13	6000	3400	6,4
Q318MPB	90	190	43	3	59	281	273	13	6000	3400	6,4
QJ1019MPA	95	145	24	1,5	84	127	76	6	7300	4500	1,5
QJ219MPA	95	170	32	2,1	93	212	200	10	6300	3700	3,3
Q219MPB	95	170	32	2,1	56	232	218	11	6300	3600	3,4
QJ319MPA	95	200	45	3	103	313	285	14	6000	3200	7,2
Q319MPB	95	200	45	3	63	310	292	14	6000	3300	7,5
QJ2319MPA	95	200	67	3	103	326	385	15	6600	3800	7,2
QJ1020MPA	100	150	24	1,5	88	122	73	6	6900	4300	1,6
QJ220MPA	100	180	34	2,1	98	241	221	11	6000	3500	4
Q220MPB	100	180	34	2,1	59	245	234	11	6600	3500	3,9
QJ320MPA	100	215	47	3	110	367	321	17	5600	3000	9,3
Q320MPB	100	215	47	3	67	369	332	17	5600	3000	9,3
QJ1021MPA	105	160	26	2	93	141	85	5	6700	4000	2
QJ221MPA	105	190	36	2,1	103	253	286	9	6000	3500	4,6
Q221MPB	105	190	36	2,1	63	276	255	10	6000	3400	4,8
QJ321MPA	105	225	49	3	116	379	325	17	5400	2800	9,9
Q321MPB	105	225	49	3	70	402	351	15	5400	2900	10,3
QJ1022MPA	110	170	28	2	98	159	98	6	6300	3800	2,4
QJ222MPA	110	200	38	2,1	109	283	311	10	5600	3400	5,6
Q222MPB	110	200	38	2,1	66	309	276	11	6000	3200	5,6
QJ322MPA	110	240	50	3	123	462	483	17	5300	2600	12,5
Q322MPB	110	240	50	3	74	468	393	17	5300	2600	12
QJ1024MPA	120	180	28	2	105	178	103	7	5700	3500	2,6
QJ224MPA	120	215	40	2,1	117	340	349	13	5300	3100	6,9
Q224MPB	120	215	40	2,1	71	371	311	14	5600	3000	6,9
QJ324MPA	120	260	55	3	133	518	384	19	5000	2400	16
Q324MPB	120	260	55	3	81	526	417	19	5000	2400	15,7
QJ2324MPA	120	260	86	3	190	519	517	19	5300	2900	22,8

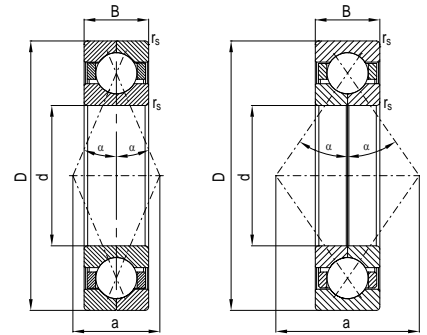

Q

QJ

Kurzzeichen	Abmessung					Tragzahl		Ermüdungs- grenzbel.	Grenz- drehzahl	Bezugs- drehzahl	Gewicht
						stat.	dyn.				
Code	Dimension					Load rating		Fatigue stress limit	Limiting speed	Reference speed	Weight
						stat.	dyn.				
	d mm	D mm	B mm	r _{s min} mm	a mm	C ₀ kN	C kN	C _u kN	n _g min ⁻¹	n _{th} min ⁻¹	kg
QJ1026MPA	130	200	33	2	116	216	125	8	5200	3200	4
QJ226MPA	130	230	40	3	126	378	374	14	5000	2800	7,7
Q226MPB	130	230	40	3	76	414	334	15	5300	2700	7,7
QJ326MPA	130	280	58	4	144	563	426	21	4800	2200	19,7
Q326MPB	130	280	58	4	87	611	463	23	4800	2200	19,7
QJ1028MPA	140	210	33	2	123	229	127	8	4800	3000	4,3
QJ228MPA	140	250	42	3	137	416	388	15	4800	2600	9,8
Q228MPB	140	250	42	3	83	450	346	17	5300	2500	9,8
QJ328MPA	140	300	62	4	154	647	470	24	4300	2000	24
Q328MPB	140	300	62	4	93	663	486	25	4300	2000	24
QJ1030MPA	150	225	35	2,1	131	292	155	11	4500	2800	5,2
QJ230MPA	150	270	45	3	147	475	413	18	4500	2400	12,4
Q230MPB	150	270	45	3	89	514	372	19	5000	2300	12,4
QJ330MPA	150	320	65	4	165	798	514	30	3800	1800	29,1
Q330MPB	150	320	65	4	100	776	538	29	3800	1800	29,1
QJ1032MPA	160	240	38	2,1	140	304	165	11	4300	2600	6,4
QJ232MPA	160	290	48	3	158	508	421	19	4300	2200	15,4
Q232MPB	160	290	48	3	96	551	381	20	4800	2200	15,4
QJ332MPA	160	340	68	4	175	811	580	30	3600	1700	30,9
Q332MPB	160	340	68	4	106	851	694	32	3600	1700	30,9
QJ1034MPA	170	260	42	2,1	151	407	343	15	3900	2400	8,5
QJ234MPA	170	310	52	4	168	605	480	22	3800	2000	19,3
Q234MPB	170	310	52	4	102	662	437	25	4500	2000	19,3
QJ334MPA	170	360	72	4	186	986	618	37	3200	1600	37,6
Q334MPB	170	360	72	4	112	995	788	37	3200	1500	37,6
QJ1036MPA	180	280	46	2,1	161	433	366	16	3700	2300	11
QJ236MPA	180	320	52	4	175	673	527	25	3600	1900	20,4
Q236MPB	180	320	52	4	106	739	480	27	4300	1800	20,4
QJ336MPA	180	380	75	4	196	1026	638	38	3000	1500	47,5
Q336MPB	180	380	75	4	119	1115	670	41	3000	1400	42,5
QJ1038MPA	190	290	46	2,1	168	460	375	17	3400	2200	11,5
QJ238MPA	190	340	55	4	186	796	607	29	3200	1700	24,4
Q238MPB	190	340	55	4	112	816	493	30	3800	1700	24,4
Q338MPB	190	400	78	5	125	1146	730	42	2800	1400	49,1
QJ1040MPA	200	310	51	2,1	179	529	421	20	3200	2000	14,9
QJ240MPA	200	360	58	4	196	852	625	32	3000	1600	29
Q240MPB	200	360	58	4	119	874	534	32	3600	1600	29
Q340MPB	200	420	80	5	132	1260	752	47	2700	1300	55,3
QJ1044MPA	220	340	56	3	196	635	477	24	3000	1800	19,6
QJ244MPA	220	400	65	4	217	988	683	37	3000	1500	37,5
Q244MPB	220	400	65	4	132	1086	633	40	3200	1400	37,5
Q344MPB	220	460	88	5	144	1391	910	52	2800	1200	72,7

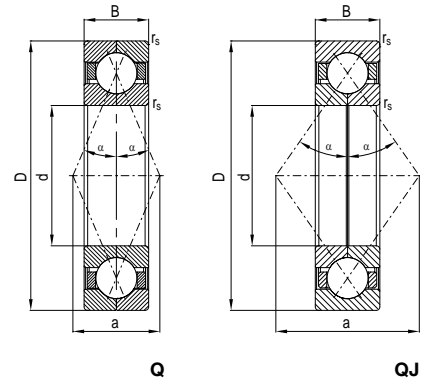
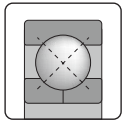

Vierpunktlager
Four Point Contact Ball Bearings

Kurzzeichen	Abmessung					Tragzahl		Ermüdungs- grenzbel.	Grenz- drehzahl	Bezugs- drehzahl	Gewicht
						stat.	dyn.				
Code	Dimension					Load rating		Fatigue stress limit	Limiting speed	Reference speed	Weight
						stat.	dyn.				
	d mm	D mm	B mm	r _{s min} mm	a mm	C ₀ kN	C kN	C _u kN	n _g min ⁻¹	n _{th} min ⁻¹	kg
QJ1948MPA	240	320	38	2,1	196,1	480,3	209,07	18	1600	-	8,93
QJ1048MPA	240	360	56	3	210	753	509	26	2700	1600	21
QJ248MPA	240	440	72	4	238	1202	785	45	2800	1300	51,1
Q248MPB	240	440	72	4	144	1320	689	49	3000	1200	51,1
Q348MPB	240	500	95	5	157	1666	1015	62	2600	1000	92,4
QJ1052MPA	260	400	65	4	231	876	597	26	2500	1500	31,4
Q252MPB	260	480	80	5	157	1567	830	46	3000	1100	67
Q352MPB	260	540	102	6	170	1973	1130	58	900	900	116
QJ1056MPA	280	420	65	4	245	982	630	29	2400	1400	33,3
Q256MPB	280	500	80	5	166	1677	860	50	2800	1000	70,6
Q356MPB	280	580	108	6	183	2208	1185	65	900	800	142
QJ1960MPA	300	420	56	3	252	879	540	26	1200	-	25
QJ1060MPA	300	460	74	4	266	1225	763	36	2200	1300	47
Q260MPB	300	540	85	5	178	1981	915	59	1100	900	88,8
QJ1064MPA	320	480	74	4	280	1303	780	39	2000	1200	49,4
Q264MPB	320	580	92	5	191	2202	1035	65	1000	800	111
QJ1068MPA	340	520	82	5	301	1551	898	46	1800	1100	66,4
QJ1972MPA	360	480	56	3	294	995	552	30	1100	-	29,6
QJ1072MPA	360	540	82	5	315	1736	952	51	1700	1100	69,5
QJ10/710MPA	710	1030	140	7,5	609	6467	2288	151	500	500	404

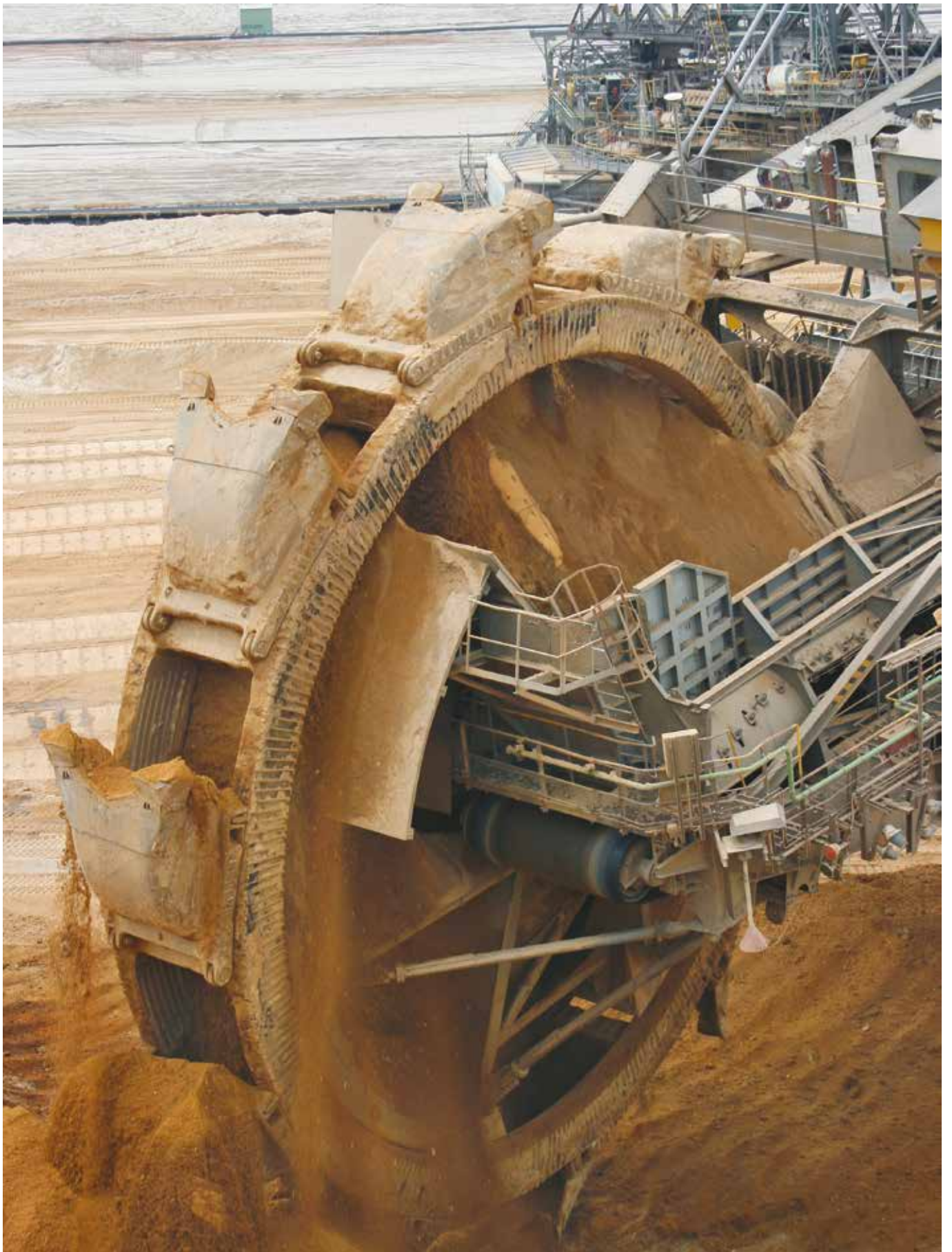

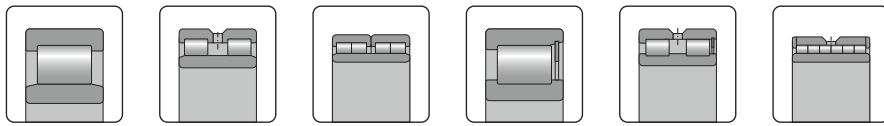

Bauformen der Zylinderrollenlager
Design versions of cylindrical roller bearings

Neben den herkömmlichen Bauformen NU und NJ werden auch andere Bauformen gefertigt. Stellvertretend für weitere Bauformen sind diese nachfolgend dargestellt:

There are not only the standard types NU and NJ, bearings of other design are manufactured as well. We quote a few samples of other design here:

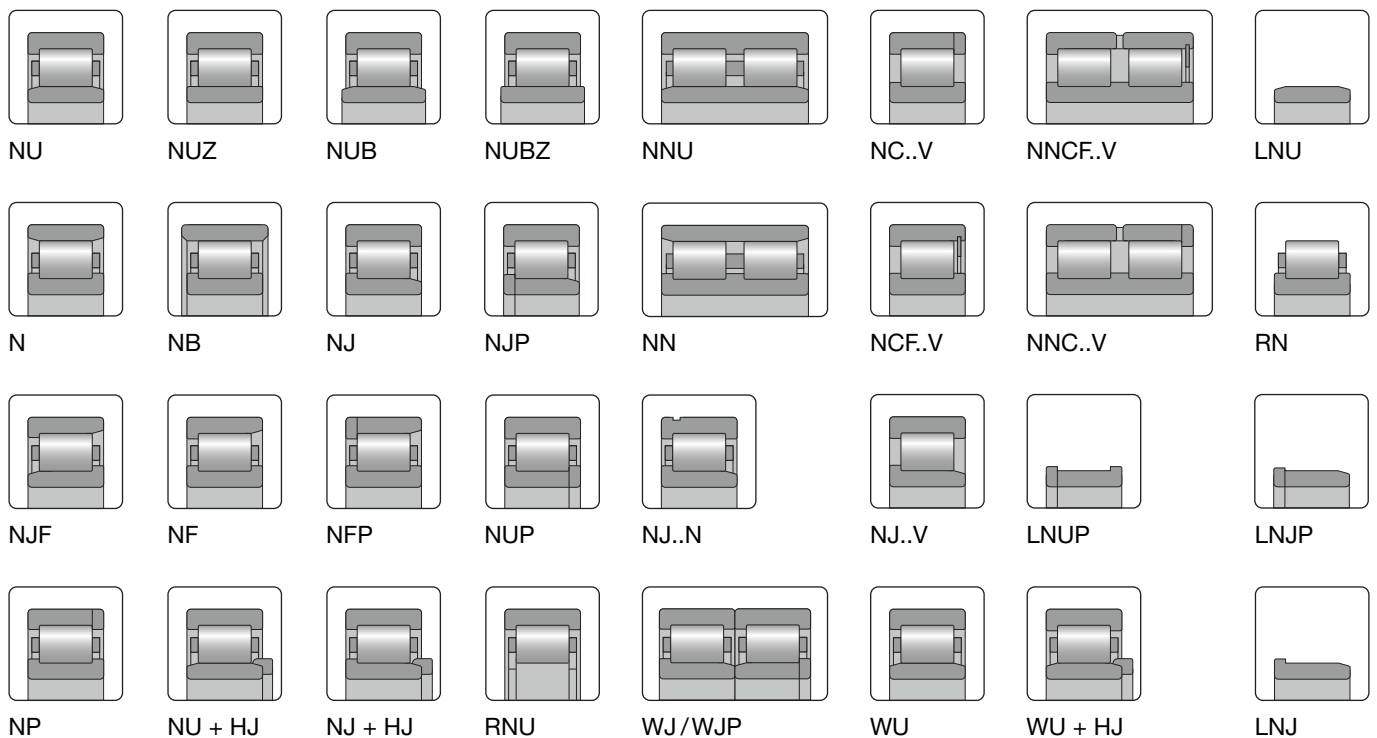

Folgende Kombinationsbezeichnungen sind üblich:

- für NU + HJ: NUJ
- für NJ + HJ: NH
- für WU + HJ: WU..W

The following combination specifications are common:

- for NU + HJ: NUJ
- for NJ + HJ: NH
- for WU + HJ: WU..W

Die nachfolgenden, technischen Angaben der Lagerbauformen NU beziehungsweise NNU stehen stellvertretend auch für alle anderen Bauformen.

The bearing versions NU or NNU are used as examples of technical specifications such as load ratings and speed limits.

Zylinderrollenlager können auch in vorgeschliffener Ausführung geliefert werden. Weiterhin besteht die Möglichkeit, Lager ohne Innenring (RNU) beziehungsweise ohne Außenring (RN), einschließlich Rollenkranz, zu beziehen.

Cylindrical roller bearings are also available with a rough-ground inner ring raceway. You can also order bearings without an inner ring (RNU) or without an outer ring (RN).

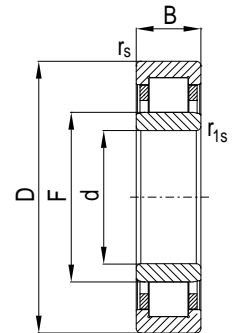
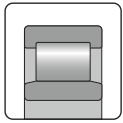

Zylinderrollenlager, einreihig

Cylindrical Roller Bearings, Single Row

NU

Kurzzeichen	Abmessung						Tragzahl		Ermüdungs- grenzbel.	Grenz- drehzahl	Bezugs- drehzahl	Gewicht
							stat.	dyn.				
Code	Dimension						Load rating		Fatigue stress limit	Limiting speed	Reference speed	Weight
							stat.	dyn.				
	d mm	D mm	B mm	r _{s,min} mm	r _{1s,min} mm	F mm	C ₀ kN	C kN	C _u kN	n _g min ⁻¹	n _{th} min ⁻¹	kg
NU1808M	40	52	7	0,3	0,15	43	9	7	1,2	14880	–	0,04
NU2808M	40	52	8	0,3	0,15	43	11	9	1,6	14880	–	0,05
NU1908E.M	40	62	12	0,6	0,3	46	24	21	3,3	12020	–	0,1
NU2908E.M	40	62	14	0,6	0,3	46	34	28	4,8	12020	–	0,2
NU3908E.M	40	62	16	0,6	0,3	46	49	36	6,8	12020	–	0,2
NU1008E.M	40	68	15	1	0,6	47	42	38	5,9	11400	8500	0,2
NU2008E.M	40	68	18	1	0,6	47	52	45	7,3	10780	–	0,3
NU3008M	40	68	21	1	0,6	47	53	44	7,5	10780	–	0,3
NU208E.M	40	80	18	1,1	1,1	49,5	51	53	7,2	9400	7700	0,4
NU2208E.M	40	80	23	1,1	1,1	49,5	72	68	10,1	8930	6500	0,5
NU308E.M	40	90	23	1,5	1,5	52	80	82	11,3	8300	7200	0,7
NU2308E.M	40	90	33	1,5	1,5	52	111	106	15,6	7810	6100	1
NU1809M	45	58	7	0,3	0,15	49	11	8	1,5	13020	–	0,05
NU2809M	45	58	8	0,3	0,15	49	14	10	1,9	13020	–	0,06
NU1909E.M	45	68	12	0,6	0,3	51,5	27	22	3,8	10780	–	0,2
NU2909E.M	45	68	14	0,6	0,3	51,5	39	30	5,5	10780	–	0,2
NU3909E.M	45	68	16	0,6	0,3	51,5	56	39	7,8	10780	–	0,2
NU1009E.M	45	75	16	1	0,6	52,5	49	43	6,9	10200	7800	0,3
NU2009E.M	45	75	19	1	0,6	52,5	64	53	9	9620	–	0,4
NU3009M	45	75	23	1	0,6	52,5	66	52	9,2	9620	–	0,4
NU209E.M	45	85	19	1,1	1,1	54,5	62	60	8,7	8800	7100	0,5
NU2209E.M	45	85	23	1,1	1,1	54,5	79	72	11,1	8330	5500	0,6
NU309E.M	45	100	25	1,5	1,5	58,5	93	94	13,1	7300	6700	1
NU2309E.M	45	100	36	1,5	1,5	58,5	144	131	20,2	6940	5500	1,4
NU1810M	50	65	7	0,3	0,15	54	12	10	1,7	11360	–	0,06
NU2810M	50	65	10	0,3	0,15	54	20	15	2,9	11360	–	0,09
NU1910E.M	50	72	12	0,6	0,3	56	31	24	4,4	10080	–	0,2
NU2910E.M	50	72	14	0,6	0,3	56	43	31	6	10080	–	0,2
NU3910E.M	50	72	16	0,6	0,3	56	61	41	8,5	10080	–	0,2
NU1010E.M	50	80	16	1	0,6	57,5	53	44	7,4	9400	7100	0,3
NU2010E.M	50	80	19	1	0,6	57,5	68	54	9,6	8930	–	0,4
NU3010M	50	80	23	1	0,6	57,5	75	57	10,5	8930	–	0,5
09.04.01	50	80	30	1,1	1,1	–	130	108	17,4	8892	–	0,55
09.04.02	50	80	40	1	0,5	–	153	98	20,5	8892	–	0,55
NU210E.M	50	90	20	1,1	1,1	59,5	67	63	9,5	8300	6700	0,5
NU2210E.M	50	90	23	1,1	1,1	59,5	86	76	12,1	7810	5400	0,6
NU310E.M	50	110	27	2	2	65	115	111	16,1	6600	6100	1,3
NU2310E.M	50	110	40	2	2	65	174	154	24,4	6250	5100	1,9
NU1811M	55	72	9	0,3	0,15	60	14	11	1,9	10080	–	0,1
NU2811M	55	72	11	0,3	0,15	60	23	16	3,3	10080	–	0,1
NU1911E.M	55	80	13	1	0,6	61,5	40	32	5,6	8930	–	0,2

► Weitere Ausführungen auf Anfrage | Other versions on request

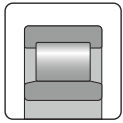

Zylinderrollenlager, einreihig
Cylindrical Roller Bearings, Single Row

Kurzzeichen	Abmessung						Tragzahl		Ermüdungs- grenzbel.	Grenz- drehzahl	Bezugs- drehzahl	Gewicht
							stat.	dyn.				
Code	Dimension						Load rating		Fatigue stress limit	Limiting speed	Reference speed	Weight
							stat.	dyn.				
	d mm	D mm	B mm	r _{s,min} mm	r _{1s,min} mm	F mm	C ₀ kN	C kN	C _u kN	n _g min ⁻¹	n _{th} min ⁻¹	kg
NU2911E.M	55	80	16	1	0,6	61,5	59	43	8,4	8930	–	0,3
NU3911E.M	55	80	19	1	0,6	61,5	79	54	11,1	8930	–	0,3
NU1011E.M	55	90	18	1,1	1	64	62	53	8,8	8300	6700	0,5
NU2011E.M	55	90	22	1,1	1	64	90	70	12,7	7810	–	0,6
NU3011M	55	90	26	1,1	1	64,5	89	66	12,6	7810	–	0,7
NU211E.M	55	100	21	1,5	1,1	66	91	81	12,9	7300	5500	0,7
NU2211E.M	55	100	25	1,5	1,1	66	113	96	15,9	6940	4800	0,9
NU311E.M	55	120	29	2	2	70,5	133	130	18,7	6000	5500	1,6
NU2311E.M	55	120	43	2	2	70,5	217	190	30,4	5680	4700	2,5
20.55.01	55	140	57	1,5	1,5	–	320	265	42,9	4788	–	5
06.05.02	59,9	110,2	22	1,5	1,5	–	104	95	13,9	6212	–	0,95
NU1812M	60	78	10	0,3	0,15	64	22	17	3,1	9190	–	0,1
NU2812M	60	78	12	0,3	0,15	64	38	26	5,4	9190	–	0,2
NU1912E.M	60	85	13	1	0,6	66,5	44	33	6,1	8330	–	0,2
NU2912E.M	60	85	16	1	0,6	66,5	60	43	8,4	8330	–	0,3
NU3912E.M	60	85	19	1	0,6	66,5	86	56	12,1	8330	–	0,4
NU1012E.M	60	95	18	1,1	1	69	69	56	9,8	7800	5500	0,5
NU2012E.M	60	95	22	1,1	1	69	100	75	14,1	7350	–	0,6
NU3012M	60	95	26	1,1	1	69,5	95	67	13,3	7350	–	0,7
06.06.03	60	100	28	1,5	–	–	153	129	20,5	6916	–	1,19
NU212E.M	60	110	22	1,5	1,5	72	99	92	13,9	6600	5500	0,9
NU2212E.M	60	110	28	1,5	1,5	72	145	124	20,5	6250	4500	1,2
06.05.01	60	130	31	2	2	–	164	162,5	22	5187	–	2
06.05.04	60	130	31	2	2	–	164	162,5	22	5187	–	2
NU312E.M	60	130	31	2,1	2,1	77	162	153	22,8	5500	5200	2,1
NU2312E.M	60	130	46	2,1	2,1	77	246	213	34,6	5210	4400	3,1
06.05.05	60	130	46	2	2	–	260	232	34,9	5187	–	3
06.05.08	60	130	46	2	2	–	259	232	34,7	5187	–	3,05
06.05.06	60	160	55	2,1	2,1	–	394	330	51,4	4150	–	5,95
08.06.01	60,5	95	44	1,5	1,1	–	200	134	26,8	7324	–	1,3
NU1813M	65	85	10	0,6	0,3	70	24	18	3,4	8330	–	0,2
NU2813M	65	85	13	0,6	0,3	70	41	27	5,8	8330	–	0,2
NU1913E.M	65	90	13	1	0,6	71,5	46	34	6,4	7810	–	0,3
NU2913E.M	65	90	16	1	0,6	71,5	70	47	9,8	7810	–	0,3
NU3913E.M	65	90	19	1	0,6	71,5	93	59	13	7810	–	0,4
NU1013E.M	65	100	18	1,1	1	74	73	58	10,3	7300	5500	0,5
NU2013E.M	65	100	22	1,1	1	74	106	77	14,8	6940	–	0,7
NU3013M	65	100	26	1,1	1	74,5	100	69	14,1	6940	–	0,8
NU213E.M	65	120	23	1,5	1,5	78,5	115	105	16,1	6000	5100	1,2
NU2213E.M	65	120	31	1,5	1,5	78,5	173	144	24,3	5680	4300	1,5
NU313E.M	65	140	33	2,1	2,1	82,5	195	183	27,5	5100	4800	2,5

► Weitere Ausführungen auf Anfrage | Other versions on request

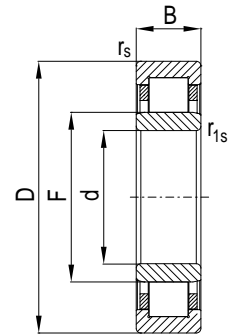

NU

Kurzzeichen	Abmessung						Tragzahl		Ermüdungs- grenzbel.	Grenz- drehzahl	Bezugs- drehzahl	Gewicht
							stat.	dyn.				
Code	Dimension						Load rating		Fatigue stress limit	Limiting speed	Reference speed	Weight
							stat.	dyn.				
	d mm	D mm	B mm	r _{s,min} mm	r _{1s,min} mm	F mm	C ₀ kN	C kN	C _u kN	n _g min ⁻¹	n _{th} min ⁻¹	kg
NU2313E.M	65	140	48	2,1	2,1	82,5	269	235	37,8	4810	4200	3,6
NU1814M	70	90	10	0,6	0,3	75	26	19	3,7	7810	–	0,2
NU2814M	70	90	13	0,6	0,3	75	45	29	6,3	7810	–	0,2
NU1914E.M	70	100	16	1	0,6	77,5	66	50	9,3	6940	–	0,4
NU2914E.M	70	100	19	1	0,6	77,5	91	64	12,8	6940	–	0,5
NU3914E.M	70	100	23	1	0,6	77,5	124	81	17,5	6940	–	0,6
NU1014E.M	70	110	20	1,1	1	79,5	94	76	13,2	6600	5400	0,7
NU2014E.M	70	110	24	1,1	1	79,5	125	95	17,6	6250	–	0,9
NU3014M	70	110	30	1,1	1	80	141	100	19,9	6250	–	1,1
NU214E.M	70	125	24	1,5	1,5	83,5	132	116	18,6	5700	4800	1,3
NU2214E.M	70	125	31	1,5	1,5	83,5	198	158	27,8	5430	3900	1,7
NU314E.M	70	150	35	2,1	2,1	89	226	207	31,8	4700	4500	3,1
NU2314E.M	70	150	51	2,1	2,1	89	302	260	42,4	4460	4000	4,5
06.06.02	70	180	42,1	3	1,5	–	334	293	42	3661	–	5,8
06.07.05	70	180	42,1	3	1,5	–	334	293	42	3661	–	5,8
06.06.01	70	240	81	3	3	–	887	678	104,3	2706	–	22,3
NU1815M	75	95	10	0,6	0,3	80	28	19	3,9	7350	–	0,2
NU2815M	75	95	13	0,6	0,3	80	49	30	6,9	7350	–	0,2
NU1915E.M	75	105	16	1	0,6	82,5	72	52	10,1	6580	–	0,4
NU2915E.M	75	105	19	1	0,6	82,5	99	67	13,9	6580	–	0,5
NU3915E.M	75	105	23	1	0,6	82,5	135	85	19	6580	–	0,6
NU1015E.M	75	115	20	1,1	1	84,5	99	79	13,9	6300	5100	0,8
NU2015E.M	75	115	24	1,1	1	84,5	132	98	18,5	5950	–	0,9
NU3015M	75	115	30	1,1	1	85	150	103	21	5950	–	1,2
NU215E.M	75	130	25	1,5	1,5	88,5	152	127	21,3	5500	4500	1,4
NU2215E.M	75	130	31	1,5	1,5	88,5	200	157	28,1	5210	3700	1,8
NU315E.M	75	160	37	2,1	2,1	95	267	243	37,6	4400	4200	3,7
NU2315E.M	75	160	55	2,1	2,1	95	368	313	51,8	4170	3700	5,4
06.07.01	75	160	55	2,1	2,1	–	395	330	50,5	4150	–	5,2
NU1816M	80	100	10	0,6	0,3	85	30	20	4,2	6940	–	0,2
NU2816M	80	100	13	0,6	0,3	85	51	31	7,2	6940	–	0,2
NU1916E.M	80	110	16	1	0,6	87,5	77	54	10,9	6250	–	0,5
NU2916E.M	80	110	19	1	0,6	87,5	106	69	15	6250	–	0,6
NU3916E.M	80	110	23	1	0,6	87,5	145	88	20,4	6250	–	0,7
NU1016E.M	80	125	22	1,1	1	91	131	101	18,5	5700	4800	1
NU2016E.M	80	125	27	1,1	1	91	172	124	24,2	5430	–	1,3
NU3016M	80	125	34	1,1	1	91,5	181	124	25,5	5430	–	1,6
NU216E.M	80	140	26	2	2	95,3	160	135	22,5	5100	4300	1,5
NU2216E.M	80	140	33	2	2	95,3	232	180	32,6	4810	3500	2,2
06.07.02	80	140	66	2	2	–	490	320	63,9	4788	–	4
06.07.04	80	140	66	2	2	–	551	352	71,8	4788	–	4

► Weitere Ausführungen auf Anfrage | Other versions on request

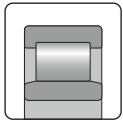

Zylinderrollenlager, einreihig
Cylindrical Roller Bearings, Single Row

Kurzzeichen	Abmessung						Tragzahl		Ermüdungs- grenzbel.	Grenz- drehzahl	Bezugs- drehzahl	Gewicht
							stat.	dyn.				
Code	Dimension						Load rating		Fatigue stress limit	Limiting speed	Reference speed	Weight
							stat.	dyn.				
	d mm	D mm	B mm	r _{s,min} mm	r _{1s,min} mm	F mm	C ₀ kN	C kN	C ₀ kN	n _g min ⁻¹	n _{th} min ⁻¹	kg
NU316E.M	80	170	39	2,1	2,1	101	291	262	40,9	4100	4000	4,3
NU2316E.M	80	170	58	2,1	2,1	101	440	362	61,9	3910	3400	5,8
NU1817M	85	110	13	1	0,6	91,5	47	33	6,6	6250	–	0,3
NU2817M	85	110	16	1	0,6	91,5	76	48	10,7	6250	–	0,4
NU1917E.M	85	120	18	1,1	1	94	94	66	13,3	5680	–	0,7
NU2917E.M	85	120	22	1,1	1	94	136	88	19,2	5680	–	0,8
NU3917E.M	85	120	26	1,1	1	94	178	109	25,1	5680	–	1
NU1017E.M	85	130	22	1,1	1	96	132	100	18,6	5500	4500	1,1
NU2017E.M	85	130	27	1,1	1	96	181	128	25,5	5210	–	1,2
NU3017M	85	130	34	1,1	1	96,5	182	123	25,7	5210	–	1,7
NU217E.M	85	150	28	2	2	100,5	189	161	26,6	4700	4100	2,2
NU2217E.M	85	150	36	2	2	100,5	264	209	37,2	4460	3400	2,8
NU317E.M	85	180	41	3	3	108	312	279	43,8	3900	3900	5,1
NU2317E.M	85	180	60	3	3	108	455	374	64,1	3680	3300	6,6
NU417E.M	85	210	52	4	0,6	113	410	376	57,7	3700	3130	8,7
NU1818M	90	115	13	1	0,6	96,5	50	34	7,1	5950	–	0,3
NU2818M	90	115	16	1	0,6	96,5	81	49	11,4	5950	–	0,4
NU1918E.M	90	125	18	1,1	1	99	98	67	13,8	5430	–	0,7
07.08.02	90	125	22	1,1	1,1	–	175	105	23	5413	–	0,8
07.08.01	90	125	22	1	1	–	176	106	23,1	5413	–	0,8
NU2918E.M	90	125	22	1,1	1	99	146	92	20,6	5430	–	0,9
NU3918E.M	90	125	26	1,1	1	99	185	111	26	5430	–	1
NU1018E.M	90	140	24	1,5	1,1	102	172	131	24,2	5100	4300	1,4
NU2018E.M	90	140	30	1,5	1,1	102	224	161	31,5	4810	–	1,8
NU3018M	90	140	37	1,5	1,1	103	226	150	31,8	4810	–	2,2
NU218E.M	90	160	30	2	2	107	211	178	29,7	4400	4000	2,5
NU2218E.M	90	160	40	2	2	107	302	235	42,5	4170	3300	3,5
NU318E.M	90	190	43	3	3	113,5	360	320	50,6	3700	3700	5,4
NU2318E.M	90	190	64	3	3	113,5	540	438	75,9	3470	3000	8,8
06.08.01	90	220	52	4	4	–	440	403	51,8	2964	–	11
NU418E.M	90	225	54	4	3	123,5	459	417	64,6	3400	2910	11,5
06.08.02	90	240	81	3	3	–	887	678	102,4	2706	–	18,4
NU1819M	95	120	13	1	0,6	101,5	52	34	7,3	5680	–	0,3
NU2819M	95	120	16	1	0,6	101,5	84	50	11,8	5680	–	0,4
NU1919E.M	95	130	18	1,1	1	104	105	70	14,8	5210	–	0,7
NU2919E.M	95	130	22	1,1	1	104	152	93	21,3	5210	–	0,9
NU3919E.M	95	130	26	1,1	1	104	204	118	28,8	5210	–	1,1
NU1019E.M	95	145	24	1,5	1,1	107	173	130	24,3	4900	4100	1,5
NU2019E.M	95	145	30	1,5	1,1	107	236	165	33,1	4630	–	1,8
NU3019M	95	145	37	1,5	1,1	108	238	154	33,5	4630	–	2,3
NU219E.M	95	170	32	2,1	2,1	112,5	254	214	35,7	4100	3700	3,2

► Weitere Ausführungen auf Anfrage | Other versions on request

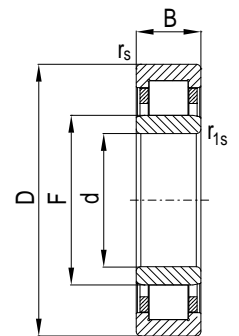

NU

Kurzzeichen	Abmessung						Tragzahl		Ermüdungs- grenzbel.	Grenz- drehzahl	Bezugs- drehzahl	Gewicht
							stat.	dyn.				
Code	Dimension						Load rating		Fatigue stress limit	Limiting speed	Reference speed	Weight
							stat.	dyn.				
	d mm	D mm	B mm	r _{s,min} mm	r _{1s,min} mm	F mm	C ₀ kN	C kN	C ₀ kN	n _g min ⁻¹	n _{th} min ⁻¹	kg
NU2219E.M	95	170	43	2,1	2,1	112,5	354	276	49,8	3910	3200	4,2
NU319E.M	95	200	45	3	3	121,5	392	338	55,2	3500	3500	6,9
NU2319E.M	95	200	67	3	3	121,5	589	464	82,8	3290	2900	10,4
NU419E.M	95	240	55	4	6	133,5	552	474	77,6	2900	2720	13,5
NU1820M	100	125	13	1	0,6	106,5	55	36	7,8	5430	-	0,4
NU2820M	100	125	16	1	0,6	106,5	89	52	12,6	5430	-	0,5
NU1920E.M	100	140	20	1,1	1	110,5	125	84	17,6	4810	-	1
NU2920E.M	100	140	24	1,1	1	110,5	188	115	26,4	4810	-	1,2
07.09.02	100	140	24	1,1	1,1	-	200	128	25,4	4788	-	1,2
NU3920E.M	100	140	30	1,1	1	110,5	238	138	33,4	4810	-	1,5
NU1020E.M	100	150	24	1,5	1,1	112	174	129	24,4	4700	4000	1,5
NU2020E.M	100	150	30	1,5	1,1	112	247	170	34,7	4460	-	1,9
NU3020M	100	150	37	1,5	1,1	113	250	159	35,2	4460	-	2,4
NU3120M	100	165	52	2	2	116,5	451	307	63,4	4030	-	4,5
NU220E.M	100	180	34	2,1	2,1	119	293	241	41,2	3900	3600	3,7
NU2220E.M	100	180	46	2,1	2,1	119	424	322	59,6	3680	3000	5,3
26.10.01-02	100	180	60,3	2,1	2,1	-	472	348	57,2	3661	-	-
20.10.01	100	200	67	3	3	-	588	463	69,8	3276	-	10
NU320E.M	100	215	47	3	3	127,5	439	389	61,7	3200	3200	8,4
06.09.02	100	215	47	3	3	-	356	310	41,7	3036	-	8,4
06.09.06	100	215	60	3	3	-	370	320	43,3	3036	-	8,4
NU2320E.M	100	215	73	3	3	127,5	732	579	102,9	3050	2500	13,2
NU420E.M	100	250	58	4	3	139	568	495	79,8	2900	2600	15,5
NU1821M	105	130	13	1	0,6	111,5	59	37	7,2	5210	-	0,4
NU2821M	105	130	16	1	0,6	111,5	94	53	11,6	5210	-	0,5
NU1921E.M	105	145	20	1,1	1	115,5	130	85	15,9	4630	-	1
NU2921E.M	105	145	24	1,1	1	115,5	194	117	23,8	4630	-	1,3
NU3921E.M	105	145	30	1,1	1	115,5	246	141	30,2	4630	-	1,6
NU1021E.M	105	160	26	2	1,1	118,5	191	143	23,4	4400	3900	1,8
NU3021M	105	160	41	2	1,1	119,5	318	197	39	4170	-	3,1
NU221E.M	105	190	36	2,1	2,1	125	318	266	38,9	3700	3500	4
06.10.04	105	190	74	2	2,1	-	320	260	38,2	3458	-	6,9
NU321E.M	105	225	49	3	3	133	489	432	60	3100	3100	9,7
NU2321E.M	105	225	77	3	3	133	815	642	99,8	2910	2400	15
NU421E.M	105	260	60	4	7,5	144,5	629	546	77,1	2700	2500	17,3
NU1822M	110	140	16	1	0,6	117,5	73	47	8,9	4810	-	0,6
NU2822M	110	140	19	1	0,6	117,5	114	66	14	4810	-	0,7
NU1922E.M	110	150	20	1,1	1	120,5	134	87	16,4	4460	-	1,1
NU2922E.M	110	150	24	1,1	1	120,5	201	119	24,6	4460	-	1,3
07.10.03	110	150	24	1,1	1,1	-	220	135	27,3	4446	-	1,3
NU3922E.M	110	150	30	1,1	1	120,5	262	146	32,2	4460	-	1,6

► Weitere Ausführungen auf Anfrage | Other versions on request

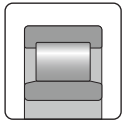

Zylinderrollenlager, einreihig
Cylindrical Roller Bearings, Single Row

Kurzzeichen	Abmessung						Tragzahl		Ermüdungs- grenzbel.	Grenz- drehzahl	Bezugs- drehzahl	Gewicht
							stat.	dyn.				
Code	Dimension						Load rating		Fatigue stress limit	Limiting speed	Reference speed	Weight
							stat.	dyn.				
	d mm	D mm	B mm	r _{s,min} mm	r _{1s,min} mm	F mm	C ₀ kN	C kN	C ₀ kN	n _g min ⁻¹	n _{th} min ⁻¹	kg
NU1022E.M	110	170	28	2	1,1	125	224	165	27,4	4100	3700	2,4
NU2022E.M	110	170	36	2	1,1	125	324	220	39,7	3910	–	3,1
NU3022M	110	170	45	2	1,1	125	373	238	45,7	3910	–	3,9
06.10.03	110	170	36	2	1,1	–	325	220	39,4	3890	–	3,1
06.10.07	110	180	50	2	2	–	382	281	45,8	3661	–	1,7
NU3122M	110	180	56	2	2	127	555	373	68	3680	–	5,8
NU222E.M	110	200	38	2,1	2,1	132,5	371	296	45,4	3500	3300	5,5
NU222E.M	110	200	53	2,1	2,1	132,5	492	370	60,3	3290	2900	7,4
NU322E.M	110	240	50	3	3	143	535	458	65,5	2900	2900	11,6
06.10.05	110	240	50	3	3	–	510	415	57,8	2706	–	10,3
06.10.06	110	240	50	3	3	–	440	510	50	2706	–	10,6
NU2322E.M	110	240	80	3	3	143	826	643	101,2	2720	2300	18,4
06.10.02	110	260	92	3	5	–	970	760	108,2	2486	–	25,5
NU422E.M	110	280	65	4	1	155	715	611	87,6	2500	2310	22
NU323E.M	115	250	53	3	3	149,5	552	454	67,6	2800	2800	14,5
06.11.01	119,987	180	28	2	1,1	–	223	157	26,5	3661	–	2,6
NU1824M	120	150	16	1	0,6	127,5	79	49	9,7	4460	–	0,7
NU2824M	120	150	19	1	0,6	127,5	121	68	14,8	4460	–	0,8
NU1924E.M	120	165	22	1,1	1	131,5	180	118	22	4030	–	1,5
NU2924E.M	120	165	27	1,1	1	131,5	236	146	28,9	4030	–	1,8
NU3924E.M	120	165	34	1,1	1	131,5	331	189	40,5	4030	–	2,3
NU1024E.M	120	180	28	2	1,1	135	226	163	27,7	3900	3500	2,6
NU2024E.M	120	180	36	2	1,1	135	341	225	41,8	3680	–	3,3
NU3024M	120	180	46	2	1,1	135	393	243	48,2	3680	–	4,2
NU3124M	120	200	62	2	2	140	674	447	82,6	3290	–	8,1
NU224E.M	120	215	40	2,1	2,1	143,5	428	339	52,4	3200	3000	5,8
NU2224E.M	120	215	58	2,1	2,1	143,5	589	435	72,1	3050	2600	9,2
20.12.02	120	218	40	2,1	2,1	–	426	338	48,8	2992	–	5,7
06.11.08	120	230	55	3	3	–	600	520	68	2829	–	3,6
06.11.02	120	240	80	4	4	–	760	560	85,5	2706	–	18
06.11.03	120	240	80	4	4	–	760	560	85,5	2706	–	18
06.11.09	120	240	80	4	4	–	760	560	85,5	2706	–	10
06.11.10	120	240	80	4	4	–	760	560	85,5	2706	–	10
NU324E.M	120	260	55	3	3	154	621	535	76	2600	2600	14,4
NU2324E.M	120	260	86	3	3	154	1039	798	127,3	2500	2000	23,1
NU424E.M	120	310	72	5	7,5	170	883	748	108,2	2100	2080	30,2
NU1826M	130	165	18	1,1	0,6	139	110	68	13,5	4030	–	0,9
NU2826M	130	165	22	1,1	0,6	139	165	93	20,2	4030	–	1,2
NU1926E.M	130	180	24	1,5	1	142	232	153	28,4	3680	–	1,9
NU2926E.M	130	180	30	1,5	1	142	306	190	37,4	3680	–	2,4
07.12.02	130	180	30	1,5	1,5	–	360	205	42,3	3661	–	4,4

► Weitere Ausführungen auf Anfrage | Other versions on request

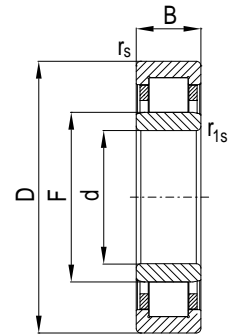

NU

Kurzzeichen	Abmessung						Tragzahl		Ermüdungs- grenzbel.	Grenz- drehzahl	Bezugs- drehzahl	Gewicht
							stat.	dyn.				
Code	Dimension						Load rating		Fatigue stress limit	Limiting speed	Reference speed	Weight
							stat.	dyn.				
	d mm	D mm	B mm	r _{s,min} mm	r _{1s,min} mm	F mm	C ₀ kN	C kN	C ₀ kN	n _g min ⁻¹	n _{th} min ⁻¹	kg
NU3926E.M	130	180	37	1,5	1	142	403	235	49,4	3680	–	2,9
NU1026E.M	130	200	33	2	1,1	147	317	228	38,8	3500	3300	3,9
06.12.02	130	200	33	2	1,1	–	309	243	35,7	3276	–	3,9
06.12.02.N	130	200	33	2	1,1	–	309	243	35,7	3276	–	3,9
NU2026E.M	130	200	42	2	1,1	147	453	301	55,5	3290	–	5
06.12.04	130	200	46	2	2	–	385	266	44,4	3276	–	5,5
06.12.07	130	200	46	2	2	–	489	347	56,4	3276	–	5,5
06.12.07/N	130	200	46	2	2	–	489	347	56,4	3276	–	5,4
NU3026M	130	200	52	2	1,1	148	580	343	71,1	3290	–	6,3
NU3126M	130	210	64	2	2	150	716	461	87,7	3130	–	8,9
NU226E.M	130	230	40	3	3	153,5	461	367	56,4	3000	2800	6,5
20.13.01	130	230	40	3	3	–	450	360	50,6	2829	–	8,84
NU2226E.M	130	230	64	3	3	153,5	700	510	85,8	2840	2400	11,3
06.12.05	130	240	80	4	4	–	918	666	102,4	2706	–	17
06.12.06	130	240	80	4	4	–	918	666	102,4	2706	–	17
06.12.08	130	260	86	3	3	–	980	720	107,6	2490	–	20,8
06.12.09	130	260	86	3	3	–	1011	699	111	2490	–	22
NU326E.M	130	280	58	4	4	167	747	624	91,6	2400	2300	18,2
06.12.10	130	280	58	4	4	–	805	665	87,1	2305	–	19,2
06.12.11	130	280	79	4	4	–	1150	930	124,4	2305	–	30,2
NU2326E.M	130	280	93	4	4	167	1244	927	152,4	2310	1800	29
NU426E.M	130	340	78	5	5	185	1081	905	132,4	1900	1890	39,3
NU1828M	140	175	18	1,1	0,6	149	117	70	14,3	3790	–	1
NU2828M	140	175	22	1,1	0,6	149	175	96	21,4	3790	–	1,2
NU1928E.M	140	190	24	1,5	1	152	241	155	29,6	3470	–	2
NU2928E.M	140	190	30	1,5	1	152	318	193	39	3470	–	2,5
NU3928E.M	140	190	37	1,5	1	152	420	239	51,4	3470	–	3,1
NU1028E.M	140	210	33	2	1,1	157	305	218	37,4	3300	3200	3,9
NU2028E.M	140	210	42	2	1,1	157	496	317	60,8	3130	–	5,3
NU3028M	140	210	53	2	1,1	158	590	354	72,3	3130	–	6,8
06.13.01	140	220	36	3	3	–	337	234	37,9	2964	–	–
06.13.04	140	220	36	2,1	2,1	–	280	203	31,5	2964	–	6
NU3128M	140	225	68	2,1	2,1	161,5	826	519	101,2	2910	–	10,8
06.13.02	140	250	40	2,5	2,5	–	535	390	58,7	2593	–	9,3
06.13.03	140	250	42	2	2	–	480	360	52,7	2593	–	10
06.13.03/N	140	250	42	2	2	–	480	360	52,7	2593	–	10
NU2228E.M	140	250	42	3	3	169	495	381	60,6	2800	2700	9,3
NU2228E.M	140	250	68	3	3	169	799	554	97,9	2600	2100	15,2
NU328E.M	140	300	62	4	4	180	818	676	100,2	2300	2200	22,3
NU2328E.M	140	300	102	4	4	180	1301	970	159,3	2160	1700	36,3
NU428E.M	140	360	82	5	1,1	198	1196	987	146,5	1700	1790	47,1

► Weitere Ausführungen auf Anfrage | Other versions on request

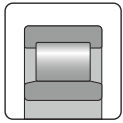

Zylinderrollenlager, einreihig
Cylindrical Roller Bearings, Single Row

Kurzzeichen	Abmessung						Tragzahl		Ermüdungs- grenzbel.	Grenz- drehzahl	Bezugs- drehzahl	Gewicht
							stat.	dyn.				
Code	Dimension						Load rating		Fatigue stress limit	Limiting speed	Reference speed	Weight
							stat.	dyn.				
	d mm	D mm	B mm	r _{s, min} mm	r _{1s, min} mm	F mm	C ₀ kN	C kN	C _u kN	n _g min ⁻¹	n _{th} min ⁻¹	kg
NU1830M	150	190	20	1,1	0,6	160	145	86	17,8	3470	–	1,4
NU2830M	150	190	24	1,1	0,6	160	242	128	29,7	3470	–	1,7
NU1930E.M	150	210	28	2	1,1	165	300	194	36,8	3130	–	3,1
NU2930E.M	150	210	36	2	1,1	165	421	252	51,5	3130	–	4
NU3930E.M	150	210	45	2	1,1	165	568	319	69,6	3130	–	5
NU1030E.M	150	225	35	2,1	1,5	168,5	333	236	40,8	3100	3000	4,8
NU2030E.M	150	225	45	2,1	1,5	168,5	559	352	68,4	2910	–	6,5
NU3030M	150	225	56	2,1	1,5	169,5	708	400	86,7	2910	–	8,2
NU3130M	150	250	80	2,1	2,1	174	1089	700	133,4	2600	–	16,3
NU230E.M	150	270	45	3	3	182	603	453	73,9	2500	2400	11,8
NU2230E.M	150	270	73	3	3	182	938	640	114,9	2400	1900	19,2
20.18.01	150	270	73	3	3	–	980	655	105,2	2394	–	14,5
NU330E.M	150	320	65	4	4	193	944	772	115,7	2100	2000	27,3
NU2330E.M	150	320	108	4	4	193	1618	1174	198,3	2020	1500	43,8
NU430E.M	150	380	85	5	12	213	1363	1080	166,9	1500	1690	53,3
NU1832M	160	200	20	1,1	0,6	170	153	88	18,8	3290	–	1,5
NU2832M	160	200	24	1,1	0,6	170	256	131	31,3	3290	–	1,8
NU1932E.M	160	220	28	2	1,1	175	322	201	39,4	2980	–	3,3
NU2932E.M	160	220	36	2	1,1	175	452	263	55,4	2980	–	4,2
NU3932E.M	160	220	45	2	1,1	175	632	340	77,4	2980	–	5,3
NU1032E.M	160	240	38	2,1	1,5	179	425	296	52	2900	2900	5,9
NU2032E.M	160	240	48	2,1	1,5	179	670	421	82,1	2720	–	7,9
NU3032M	160	240	60	2,1	1,5	180	760	441	93,1	2720	–	9,9
NU3132M	160	270	86	2,1	2,1	187	1254	796	153,6	2400	–	20,8
NU232E.M	160	290	48	3	3	195	689	512	84,5	2400	2200	14,6
NU2232E.M	160	290	80	3	3	193	1137	781	139,3	2230	1700	24,3
NU332E.M	160	340	68	4	4	204	1077	873	131,9	2000	1800	32,1
NU2332E.M	160	340	114	4	4	204	1843	1325	225,8	1890	1300	52,1
NU432E.M	160	400	88	5	5	226	1471	1156	180,2	1400	1600	60,6
06.14.03	169,5	225	35	2,1	2,1	–	310	208	33,9	2895	–	3,5
NU1834M	170	215	22	1,1	0,6	182	173	101	21,2	3050	–	1,9
NU2834M	170	215	27	1,1	0,6	182	267	141	32,7	3050	–	2,4
NU1934E.M	170	230	28	2	1,1	185	334	204	40,9	2840	–	3,4
NU2934E.M	170	230	36	2	1,1	185	483	273	59,2	2840	–	4,4
NU3934E.M	170	230	45	2	1,1	185	634	337	77,7	2840	–	5,6
NU1034E.M	170	260	42	2,1	2,1	191	519	364	63,6	2600	2600	7,8
NU2034E.M	170	260	54	2,1	2,1	191	703	461	86,1	2500	–	10,7
NU3034M	170	260	67	2,1	2,1	193	965	549	118,2	2500	–	13,5
06.16.02	170	265	42	2	2	–	450	316	47,8	2441	–	8
06.16.01	170	265	42	3	3	–	570	380	60,6	2441	–	8,8
NU3134M	170	280	88	2,1	2,1	197	1329	824	162,8	2310	–	22,3

► Weitere Ausführungen auf Anfrage | Other versions on request

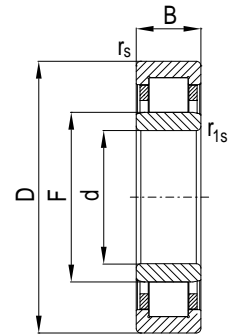

NU

Kurzzeichen	Abmessung						Tragzahl		Ermüdungs- grenzbel.	Grenz- drehzahl	Bezugs- drehzahl	Gewicht
							stat.	dyn.				
Code	Dimension						Load rating		Fatigue stress limit	Limiting speed	Reference speed	Weight
							stat.	dyn.				
	d mm	D mm	B mm	r _{s,min} mm	r _{1s,min} mm	F mm	C ₀ kN	C kN	C ₀ kN	n _g min ⁻¹	n _{th} min ⁻¹	kg
NU234E.M	170	310	52	4	4	207	816	612	100	2200	2000	18,1
NU2234E.M	170	310	86	4	4	205	1429	973	175,1	2080	1500	29,8
NU334E.M	170	360	72	4	4	216	1220	979	149,4	1900	1600	38,5
NU2334E.M	170	360	120	4	4	216	2084	1485	255,3	1790	1200	59,5
NU434E.M	170	420	92	5	0,3	239	1567	1225	192	1400	1520	69,6
NU1836M	180	225	22	1,1	0,6	192	183	104	22,4	2910	-	2
NU2836M	180	225	27	1,1	0,6	192	275	142	33,6	2910	-	2,5
NU1936E.M	180	250	33	2	1,1	197	411	260	50,4	2600	-	5,1
NU2936E.M	180	250	42	2	1,1	197	588	344	72,1	2600	-	6,5
NU3936E.M	180	250	52	2	1,1	197	809	441	99,1	2600	-	8,1
NU1036E.M	180	280	46	2,1	2,1	204	637	446	78	2400	2400	10,5
NU2036E.M	180	280	60	2,1	2,1	204	1001	633	122,6	2310	-	14,2
NU3036M	180	280	74	2,1	2,1	205	1186	680	145,3	2310	-	17,8
NU3136M	180	300	96	3	3	211	1516	930	185,7	2160	-	28,3
NU236E.M	180	320	52	4	4	217	867	635	106,2	2100	1800	18,8
06.17.01	180	320	86	4	4	-	1534	1019	156,3	2008	-	31,1
06.17.02	180	320	86	4	4	-	1534	1019	156,3	2008	-	31,1
NU2236E.M	180	320	86	4	4	215	1440	971	176,4	2020	1400	31,1
NU336E.M	180	380	75	4	4	230	1327	1054	162,5	1800	1500	44,4
NU2336E.M	180	380	126	4	4	230	2308	1621	282,8	1690	1100	68,4
NU1838M	190	240	24	1,5	1,1	203	241	139	29,5	2720	-	2,6
NU2838M	190	240	30	1,5	1,1	203	374	195	45,8	2720	-	3,3
NU1938E.M	190	260	33	2	1,1	207	442	272	54,1	2500	-	5,3
NU2938E.M	190	260	42	2	1,1	207	652	367	79,8	2500	-	6,8
NU3938E.M	190	260	52	2	1,1	207	869	460	106,4	2500	-	8,5
NU1038E.M	190	290	46	2,1	2,1	214	671	459	82,2	2400	2300	11
06.18.04	190	290	46	2,1	2,1	-	542	366	55,9	2223	-	11,2
NU2038E.M	190	290	60	2,1	2,1	214	1052	651	128,9	2230	-	15
NU3038M	190	290	75	2,1	2,1	215	1242	697	152,1	2230	-	18,8
NU3138M	190	320	104	3	3	222	1802	1117	220,8	2020	-	35,2
NU238E.M	190	340	55	4	4	230	971	704	118,9	2000	1700	22,7
NU2238E.M	190	340	92	4	4	228	1687	1112	206,7	1890	1300	37,8
NU338E.M	190	400	78	5	5	242	1468	1159	179,8	1700	1400	48
06.18.02	190	400	105	5	5	-	2230	1650	216,2	1596	-	120
NU2338E.M	190	400	132	5	5	242	2560	1787	313,7	1600	1100	81,1
06.20.01	199,979	320	48	2	2	-	633	431	61,1	2008	-	14
NU1840M	200	250	24	1,5	1,1	213	248	140	30,4	2600	-	2,7
NU2840M	200	250	30	1,5	1,1	213	395	201	48,4	2600	-	3,4
NU1940E.M	200	280	38	2,1	1,5	220	533	327	65,3	2310	-	7,5
NU2940E.M	200	280	48	2,1	1,5	220	769	435	94,2	2310	-	9,6
NU3940E.M	200	280	60	2,1	1,5	220	1056	556	129,4	2310	-	12

► Weitere Ausführungen auf Anfrage | Other versions on request

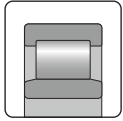

Zylinderrollenlager, einreihig
Cylindrical Roller Bearings, Single Row

Kurzzeichen	Abmessung						Tragzahl		Ermüdungs- grenzbel.	Grenz- drehzahl	Bezugs- drehzahl	Gewicht
							stat.	dyn.				
Code	Dimension						Load rating		Fatigue stress limit	Limiting speed	Reference speed	Weight
							stat.	dyn.				
	d mm	D mm	B mm	r _{s,min} mm	r _{1s,min} mm	F mm	C ₀ kN	C kN	C ₀ kN	n _g min ⁻¹	n _{th} min ⁻¹	kg
NU1040E.M	200	310	51	2,1	2,1	227	718	495	88	2200	2200	14,5
NU2040E.M	200	310	66	2,1	2,1	227	1234	753	151,1	2080	-	19,5
06.19.01	200	310	66	2,1	2,1	-	915	550	95	2080	-	19,5
NU3040M	200	310	82	2,1	2,1	229	1413	776	173	2080	-	24,2
NU3140M	200	340	112	3	3	233	2098	1312	257	1890	-	42,8
06.22.02	200	340	140	3	3	-	3300	1870	328,6	1886	-	51,1
NU240E.M	200	360	58	4	4	243	1080	776	132,3	1900	1600	26,9
NU2240E.M	200	360	98	4	4	241	1898	1235	232,5	1790	1200	45,6
NU340E.M	200	420	80	5	5	258	1485	1159	181,9	1600	1400	57
NU2340E.M	200	420	138	5	5	254	2843	1970	348,3	1520	1000	93,4
20.20.01	203,2	330,2	44,45	4	4	-	789	526	78,9	1944	-	19
06.21.01	218	290	100	2	2	-	704	390	71,4	2223	-	21,1
NU1844M	220	270	24	1,5	1,1	232	275	148	33,7	2400	-	3
NU2844M	220	270	30	1,5	1,1	232	448	217	54,9	2400	-	3,8
NU1944E.M	220	300	38	2,1	1,5	240	555	330	67,9	2160	-	8,1
NU2944E.M	220	300	48	2,1	1,5	240	878	471	107,6	2160	-	10,4
NU3944E.M	220	300	60	2,1	1,5	240	1133	575	138,8	2160	-	13
NU1044E.M	220	340	56	3	3	250	861	577	105,5	2000	2000	18
NU2044E.M	220	340	72	3	3	250	1435	858	175,8	1890	-	25
NU3044M	220	340	90	3	3	250	1730	965	195	1890	-	31,6
NU3144M	220	370	120	4	4	256	2443	1484	299,3	1740	-	54,1
NU244E.M	220	400	65	4	4	268	1353	961	165,7	1700	1400	38,5
NU2244E.M	220	400	108	4	4	259	2422	1661	296,7	1600	1000	62
NU344E.M	220	460	88	5	5	282	1959	1482	240	1500	1100	75,5
NU2344E.M	220	460	145	5	5	279	3239	2229	396,8	1390	900	117
20.23.01	229,954	370	100	-	-	-	2120	1190	204,5	1729	-	44,5
NU1848M	240	300	28	2	1,1	255	397	216	48,6	2160	-	4,5
NU2848M	240	300	36	2	1,1	255	614	303	75,2	2160	-	5,9
NU1948E.M	240	320	38	2,1	1,5	260	628	356	76,9	2020	-	8,8
NU2948E.M	240	320	48	2,1	1,5	260	936	485	114,6	2020	-	11,1
NU3948E.M	240	320	60	2,1	1,5	260	1209	593	148,1	2020	-	14
NU1048E.M	240	360	56	3	3	270	906	590	111	1900	1800	19,7
NU2048E.M	240	360	72	3	3	270	1574	905	192,8	1790	-	52
NU3048M	240	360	92	3	3	270	1900	1000	226,1	1790	-	34,5
06.23.01	240	390	107,95	3	3	-	2640	1650	251	1638	-	43,2
NU3148M	240	400	128	4	4	278	2817	1688	345,1	1600	-	66,7
06.23.04	240	420	128	4	4	-	2800	1660	262,5	1518	-	80
NU248E.M	240	440	72	4	4	294	1591	1128	194,9	1500	1200	52,3
06.23.03	240	440	120	4	4	-	1500	1200	139,4	1447	-	85
NU2248E.M	240	440	120	4	4	289	2961	1905	362,7	1450	900	85
NU348E.M	240	500	95	5	5	306	2350	1757	287,9	1300	1000	96,7

► Weitere Ausführungen auf Anfrage | Other versions on request

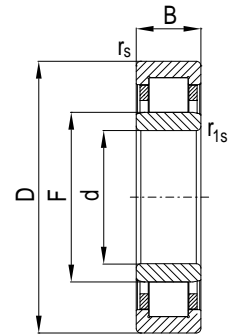

NU

Kurzzeichen	Abmessung						Tragzahl		Ermüdungs- grenzbel.	Grenz- drehzahl	Bezugs- drehzahl	Gewicht
							stat.	dyn.				
Code	Dimension						Load rating		Fatigue stress limit	Limiting speed	Reference speed	Weight
							stat.	dyn.				
	d mm	D mm	B mm	r _{s min} mm	r _{1s min} mm	F mm	C ₀ kN	C kN	C ₀ kN	n _g min ⁻¹	n _{th} min ⁻¹	kg
NU2348E.M	240	500	155	5	5	303	3750	2600	443,1	1280	800	156
NU1852M	260	320	28	2	1,1	275	437	228	46,2	2020	–	4,9
NU2852M2	260	320	36	2	1,1	275	662	315	69,9	2020	–	6,4
NU1952E.M	260	360	46	2,1	1,5	286	900	516	95	1790	–	14,8
NU2952E.M	260	360	60	2,1	1,5	286	1315	694	138,9	1790	–	19,4
NU3952E.M	260	360	75	2,1	1,5	286	1730	859	182,8	1790	–	24,3
NU1052E.M	260	400	65	4	4	294	1212	794	128,1	1700	1600	29,3
06.25.01	260	400	82	4	4	–	1800	1085	168,8	1596	–	40
NU2052E.M	260	400	82	4	4	294	2030	1185	214,4	1600	–	40
NU3052M	260	400	104	4	4	296	2435	1286	257,2	1600	–	50,4
NU3152M	260	440	144	4	4	304	3257	1909	367,8	1450	–	92,5
NU252E.M	260	480	80	5	5	319	1932	1353	204,1	1400	1100	65,6
NU2252E.M	260	480	130	5	5	313	3645	2317	385	1330	700	110
NU352E.M	260	540	102	6	6	337	2733	2010	288,6	1200	900	120
NU2352E.M	260	540	165	6	6	328	4633	3080	489,4	1180	700	193
NU1856M	280	350	33	2	1,1	299	475	247	50,1	1840	–	7,4
NU2856M	280	350	42	2	1,1	299	688	329	72,6	1840	–	9,5
NU1956E.M	280	380	46	2,1	1,5	306	960	534	101,3	1690	–	15,7
NU2956E.M	280	380	60	2,1	1,5	306	1402	717	148,1	1690	–	20,6
NU3956E.M	280	380	75	2,1	1,5	306	1845	888	194,9	1690	–	25,8
NU1056E.M	280	420	65	4	4	314	1274	813	134,6	1600	1500	30,8
NU2056E.M	280	420	82	4	4	314	2133	1214	225,3	1520	–	42
NU3056M	280	420	106	4	4	316	2648	1351	279,7	1520	–	54,5
NU3156M	280	460	146	5	5	324	3697	2130	390,5	1390	–	98,9
NU256E.M	280	500	80	5	5	339	2057	1404	217,3	1300	1000	69,2
NU2256E.M	280	500	130	5	5	327	3250	2159	343,3	1280	800	115
NU356E.M	280	580	108	6	6	362	3062	2195	323,4	1200	800	147
NU2356E.M	280	580	175	6	6	353	5381	3522	568,3	1100	600	235
NU1860M	300	380	38	2,1	1,5	322	656	340	69,2	1690	–	10,8
NU2860M	300	380	48	2,1	1,5	322	1012	476	106,9	1690	–	13,4
NU1960E.M	300	420	56	3	3	330	1194	695	126,1	1520	–	24,8
NU2960E.M	300	420	72	3	3	330	1989	1034	210,1	1520	–	32,3
NU3960E.M	300	420	90	3	3	330	2467	1223	260,6	1520	–	40,4
NU1060E.M	300	460	74	4	4	341	1540	974	162,7	1500	1400	46,6
NU2060E.M	300	460	95	4	4	341	2756	1530	291,1	1390	–	61
06.29.02	300	460	95	4	4	–	2390	1380	214,8	1383	–	61
NU3060M	300	460	118	4	4	340	3331	1730	351,8	1390	–	75,2
NU3160M	300	500	160	5	5	348	4371	2532	461,7	1280	–	130
NU260E.M	300	540	85	5	5	363	2428	1644	256,4	1200	900	86,5
NU2260E.M	300	540	140	5	5	359	4359	2677	460,4	1180	600	147
NU360E.M	300	620	109	7,5	7,5	388	3089	2142	326,3	1100	800	169

► Weitere Ausführungen auf Anfrage | Other versions on request

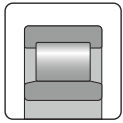

Zylinderrollenlager, einreihig
Cylindrical Roller Bearings, Single Row

Kurzzeichen	Abmessung						Tragzahl		Ermüdungs- grenzbel.	Grenz- drehzahl	Bezugs- drehzahl	Gewicht
							stat.	dyn.				
Code	Dimension						Load rating		Fatigue stress limit	Limiting speed	Reference speed	Weight
							stat.	dyn.				
	d mm	D mm	B mm	r _{s,min} mm	r _{1s,min} mm	F mm	C ₀ kN	C kN	C ₀ kN	n _g min ⁻¹	n _{th} min ⁻¹	kg
NU2360E.M	300	620	185	7,5	7,5	378	5771	3790	609,6	1020	500	283
NU1864M	320	400	38	2,1	1,5	341	688	348	72,7	1600	-	11,5
NU2864M	320	400	48	2,1	1,5	341	1039	479	109,7	1600	-	14,2
NU1964E.M	320	440	56	3	3	348	1200	689	126,7	1450	-	26,2
20.32.01	320	440	56	3	3	-	1210	695	108,7	1447	-	26,2
NU2964E.M	320	440	72	3	3	350	2064	1050	218	1450	-	34,1
NU3964E.M	320	440	90	3	3	350	2559	1241	270,3	1450	-	42,7
NU1064E.M	320	480	74	4	4	361	1614	997	170,5	1400	1300	46,3
06.31.01	320	480	74	4	4	-	1430	880	132	2200	1400	45,8
NU2064E.M	320	480	95	4	4	361	2995	1609	316,3	1330	-	64
NU3064M	320	480	121	4	4	360	3746	1869	395,7	1330	-	80,9
NU3164M	320	540	176	5	5	374	5044	2888	532,8	1180	-	170
NU264E.M	320	580	92	5	5	389	2840	1906	300	1200	800	108
NU2264E.M	320	580	150	5	5	385	4900	3150	512,5	1100	600	184
NU364E.M	320	670	112	7,5	7,5	411,1	3215	2326	335	1000	700	205
NU2364E.M	320	670	200	7,5	7,5	393	7095	4845	749,4	950	500	354
NU1868M	340	420	38	2,1	1,5	361,5	736	361	77,8	1520	-	12
NU2868M	340	420	48	2,1	1,5	361,5	1113	498	117,6	1520	-	15
NU1968E.M	340	460	56	3	3	370	1244	699	131,4	1390	-	27,6
NU2968E.M	340	460	72	3	3	370	2203	1089	232,7	1390	-	35,9
07.33.01	340	460	72	3	3	-	2500	1200	221,3	1383	-	37,4
NU3968E.M	340	460	90	3	3	370	2651	1258	280,1	1390	-	44,8
NU1068E.M	340	520	82	5	5	385	2028	1258	214,2	1300	1100	65
NU2068E.M	340	520	106	5	5	385	3470	1911	366,6	1230	-	86
NU3068M	340	520	133	5	5	385	4210	2147	444,7	1230	-	108
12.33.03	340	520	133	5	5	-	4150	2150	359,4	1230	-	108
NU3168M	340	580	190	5	5	399	5717	3244	603,9	1100	-	215
NU268E.M	340	620	92	6	6	419	3078	1981	325,1	1100	700	131
NU2268E.M	340	620	165	6	6	408	5450	3366	575,6	1020	500	231
06.35.02	355	540	82	5	5	-	2080	1260	178	1174	-	69,3
NU1872M	360	440	38	2,1	1,5	381,5	769	368	81,3	1450	-	12,5
NU2872M	360	440	48	2,1	1,5	381,5	1187	516	125,4	1450	-	15,8
06.35.01	360	460	100	3	3	-	3350	1290	294,3	1383	-	31
NU1972E.M	360	480	56	3	3	390	1366	741	144,3	1330	-	29
NU2972E.M	360	480	72	3	3	390	2277	1103	240,5	1330	-	37,7
NU3972E.M	360	480	90	3	3	390	2904	1332	306,8	1330	-	47,1
NU1072E.M	360	540	82	5	5	405	2124	1289	224,4	1200	1100	67,5
NU2072E.M	360	540	106	5	5	405	3635	1958	383,9	1180	-	90
NU3072M	360	540	134	5	5	405	4400	2200	485,2	1180	-	113
NU3172M	360	600	192	5	5	420	6060	3358	640,1	1060	-	227
06.37.03	380	480	46	2,1	2,1	-	480	285	41,6	1330	-	26,3

► Weitere Ausführungen auf Anfrage | Other versions on request

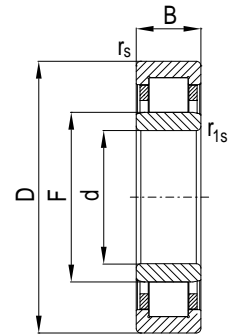

NU

Kurzzeichen	Abmessung						Tragzahl		Ermüdungs- grenzbel.	Grenz- drehzahl	Bezugs- drehzahl	Gewicht
							stat.	dyn.				
Code	Dimension						Load rating		Fatigue stress limit	Limiting speed	Reference speed	Weight
							stat.	dyn.				
	d mm	D mm	B mm	r _{s,min} mm	r _{1s,min} mm	F mm	C ₀ kN	C kN	C ₀ kN	n _g min ⁻¹	n _{th} min ⁻¹	kg
06.37.04	380	480	46	2,1	2,1	–	483	285	41,8	1330	–	20,5
NU1876M	380	480	46	2,1	2,1	407,5	1005	493	106,2	1330	–	21
06.37.05	380	480	50	2,1	1,5	–	1120	561	97	1330	–	22
NU2876M	380	480	60	2,1	2,1	407,5	1544	688	163,1	1330	–	26,8
NU1976E.M	380	520	65	4	4	414	1745	970	184,3	1230	–	41,9
NU2976E.M	380	520	82	4	4	414	2823	1410	298,2	1230	–	53,5
NU3976E.M	380	520	106	4	4	414	3720	1746	392,9	1230	–	69,2
06.38.01	380	540	180	4	4	–	6400	2800	543,2	1230	–	131,2
NU1076E.M	380	560	82	5	5	425	2306	1357	243,5	1200	1000	68,6
NU2076E.M	380	560	106	5	5	428	3741	1907	395,1	1140	–	96
NU3076M	380	560	135	5	5	425	4550	2240	525,8	1140	–	119
NU3176M	380	620	194	5	5	440	6402	3468	676,2	1020	–	239
NU1880M	400	500	46	2,1	2,1	428	1075	513	113,6	1280	–	21,5
NU2880M	400	500	60	2,1	2,1	428	1617	705	170,8	1280	–	27,9
NU1980E.M	400	540	65	4	4	434	1916	1030	202,3	1180	–	43,8
NU2980E.M	400	540	82	4	4	434	3011	1465	318	1180	–	56
NU3980E.M	400	540	106	4	4	434	3847	1772	406,4	1180	–	72,4
NU1080E.M	400	600	90	5	5	449	2803	1677	296	1100	900	89,4
NU2080E.M	400	600	118	5	5	450	4221	2194	445,9	1060	–	125
NU3080M	400	600	148	5	5	449	5400	2650	566,3	1060	–	155
NU3180M	400	650	200	6	6	460	7271	3972	768	980	–	267
06.41.02	416	620	90	5	5	–	2140	1350	175,3	1020	–	98
NU1884M	420	520	46	2,1	2,1	448	1167	540	123,3	1230	–	22,5
06.41.01	420	520	46	2,1	2,1	–	580	320	48,9	1230	–	19
NU2884M	420	520	60	2,1	2,1	448	1793	753	189,4	1230	–	29,2
NU1984E.M	420	560	65	4	4	454	1922	1022	203,1	1140	–	45,6
NU2984E.M	420	560	82	4	4	454	3199	1517	337,9	1140	–	58,3
NU3984E.M	420	560	106	4	4	454	3974	1798	419,8	1140	–	75,4
NU1084E.M	420	620	90	5	5	469	2928	1717	309,3	1100	900	96,2
NU2084E.M	420	620	118	5	5	473	4568	2303	482,5	1020	–	130
NU3084M	420	620	150	5	5	470	5745	2759	606,8	1020	–	163
NU3184M	420	700	224	6	6	485	8345	4532	881,5	910	–	357
06.18.01	440	540	40	2,1	2,1	–	940	420	78,3	1180	–	15,8
06.43.02	440	540	40	2,1	2,1	–	615	315	51,2	1180	–	20
NU1888M	440	540	46	2,1	2,1	466	1173	550	123,9	1180	–	23,5
06.43.03	440	540	46	2,1	2,1	–	619	333	51,5	1180	–	21
NU2888M	440	540	60	2,1	2,1	468	1762	736	186,1	1180	–	30,4
NU1988E.M	440	600	74	4	4	480	2253	1204	238	1060	–	63,5
NU2988E.M	440	600	95	4	4	480	3871	1834	408,9	1060	–	82,7
NU3988E.M	440	600	118	4	4	480	4818	2173	508,9	1060	–	103
06.43.01	440	620	80	4	4	–	1370	1260	111,4	1020	–	80,7

► Weitere Ausführungen auf Anfrage | Other versions on request

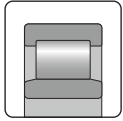

Zylinderrollenlager, einreihig
Cylindrical Roller Bearings, Single Row

Kurzzeichen	Abmessung						Tragzahl		Ermüdungs- grenzbel.	Grenz- drehzahl	Bezugs- drehzahl	Gewicht
							stat.	dyn.				
Code	Dimension						Load rating		Fatigue stress limit	Limiting speed	Reference speed	Weight
							stat.	dyn.				
	d mm	D mm	B mm	r _{s min} mm	r _{1s min} mm	F mm	C ₀ kN	C kN	C ₀ kN	n _g min ⁻¹	n _{th} min ⁻¹	kg
NU1088E.M	440	650	94	6	6	494	3171	1803	334,9	1000	800	110
NU2088E.M	440	650	122	6	6	492	4969	2589	524,9	980	–	145
NU3088M	440	650	157	6	6	493	6491	3060	685,6	980	–	181
NU3188M	440	720	226	6	6	505	9420	5092	995	880	–	373
06.44.01	450	780	105	3	3	–	4390	3050	341,5	808	–	260
NU1892M	460	580	56	3	3	494	1485	691	156,9	1100	–	36,5
NU2892M	460	580	72	3	3	494	2399	1004	253,4	1100	–	47
NU1992E.M	460	620	74	4	4	500	2394	1248	252,8	1020	–	65,9
NU2992E.M	460	620	95	4	4	500	4112	1902	434,3	1020	–	85,8
NU3992E.M	460	620	118	4	4	500	4971	2204	525,1	1020	–	106
NU1092E.M	460	680	100	6	6	514	3467	2008	366,2	1000	800	121
NU2092E.M	460	680	128	6	6	513	5617	2923	593,3	930	–	168
NU3092M	460	680	163	6	6	516	7046	3293	744,3	930	–	215
NU3192M	460	760	240	7,5	7,5	531	10639	5710	1123,7	830	–	448
06.46.01	469,9	698,5	139,7	6	6	–	5892	3136	465,5	904	–	191,5
20.00.01	475	669	78	5	3	–	2250	1150	178,9	945	–	93,1
NU1896M	480	600	56	3	3	514	1519	697	160,4	1060	–	38
NU2896M	480	600	72	3	3	514	2503	1027	264,3	1060	–	49
NU1996E.M	480	650	78	5	5	523	2680	1400	283,1	980	–	77,1
NU2996E.M	480	650	100	5	5	523	4726	2174	499,1	980	–	100
NU3996E.M	480	650	128	5	5	523	5710	2519	603,1	980	–	128
NU1096E.M	480	700	100	6	6	534	3614	2055	381,7	1000	700	126
NU2096E.M	480	700	128	6	6	533	6073	3075	641,4	910	–	173
NU3096M	480	700	165	6	6	536	7324	3363	773,6	910	–	225
NU3196M	480	790	248	7,5	7,5	556	11241	5901	1187,3	800	–	500
NU18/500M	500	620	56	3	3	534	1613	722	170,4	1020	–	40
NU28/500M	500	620	72	3	2	534	2557	1034	270	1020	–	52
NU19/500E.M	500	670	78	5	5	543	2841	1450	300,1	950	–	79,8
NU29/500E.M	500	670	100	5	5	543	4871	2206	514,5	950	–	104
NU39/500E.M	500	670	128	5	5	543	5886	2556	621,7	950	–	133
NU10/500E.M	500	720	100	6	6	554	3762	2101	397,3	900	700	131
NU20/500E.M	500	720	128	6	6	553	5877	2977	620,8	880	–	177
NU30/500M	500	720	167	6	6	556	7601	3430	802,9	880	–	235
NU31/500M	500	830	264	7,5	7,5	581	12601	6575	1331	760	–	595
20.05.01	505	712	82	5	5	–	2500	1250	195,1	887	–	110,5
NU18/530M	530	650	56	3	3	564	1678	735	151,1	980	–	41
NU28/530M	530	650	72	3	3	564	2662	1052	239,6	980	–	54
NU19/530E.M	530	710	82	5	5	575	3246	1642	292,1	890	–	94,2
NU29/530E.M	530	710	106	5	5	575	5403	2443	486,3	890	–	124
NU39/530E.M	530	710	136	5	5	575	5620	2529	505,8	890	–	156
NU10/530E.M	530	780	112	6	6	590	4725	2683	425,2	900	600	176

► Weitere Ausführungen auf Anfrage | Other versions on request

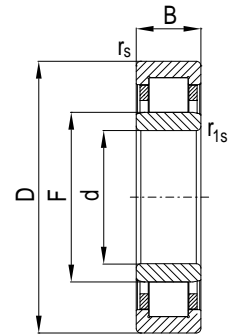

NU

Kurzzeichen	Abmessung						Tragzahl		Ermüdungs- grenzbel.	Grenz- drehzahl	Bezugs- drehzahl	Gewicht
							stat.	dyn.				
Code	Dimension						Load rating		Fatigue stress limit	Limiting speed	Reference speed	Weight
							stat.	dyn.				
	d mm	D mm	B mm	r _{s,min} mm	r _{1s,min} mm	F mm	C ₀ kN	C kN	C _u kN	n _g min ⁻¹	n _{th} min ⁻¹	kg
NU20/530E.M	530	780	145	6	6	594	7030	3510	632,7	810	–	247
NU30/530M	530	780	185	6	6	591	9150	4300	854,9	810	–	317
NU31/530M	530	870	272	7,5	7,5	611	12647	6724	1138,2	730	–	657
06.55.01	560	680	56	3	3	–	914	480	70,9	930	–	13,3
NU18/560M	560	680	56	3	3	594	1713	737	154,2	930	–	44
NU28/560M	560	680	72	3	3	594	2817	1085	253,5	930	–	56
NU19/560E.M	560	750	85	5	5	608	3440	1734	309,6	840	–	109
NU29/560E.M	560	750	112	5	5	608	6168	2730	555,1	840	–	146
NU39/560E.M	560	750	140	5	5	608	6507	2855	585,6	840	–	180
NU10/560E.M	560	820	115	6	6	625	4936	2739	444,2	800	600	197
NU20/560E.M	560	820	150	6	6	629	7592	3674	683,3	770	–	284
NU30/560M	560	820	195	6	6	626	10076	4547	906,9	770	–	367
NU31/560M	560	920	280	7,5	7,5	646	14784	7691	1330,5	690	–	763
06.59.01	596	1090	155	7,5	7,5	–	10300	5292	730	576	–	793
06.55.02	599,104	685,8	100	5	5	–	5241	2106	402,4	921	–	82,5
NU18/600M	600	730	60	3	3	637	2083	874	187,4	870	–	54
NU28/600M	600	730	78	3	3	637	3421	1286	307,9	870	–	56
NU19/600E.M	600	800	90	5	5	649	4139	2053	372,5	790	–	130
NU29/600E.M	600	800	118	5	5	649	6870	3047	618,3	790	–	172
NU39/600E.M	600	800	150	5	5	649	7600	3304	684	790	–	217
NU10/600E.M	600	870	118	6	6	665	5605	3091	504,4	800	500	226
NU20/600E.M	600	870	155	6	6	669	8733	4198	786	730	–	321
NU30/600M	600	870	200	6	6	667	11102	4989	999,2	730	–	417
NU31/600M	600	980	300	7,5	7,5	692	16366	8413	1473	640	–	919
06.61.01	620	750	60	3	3	–	1640	725	123,5	841	–	50,8
06.62.01	630	780	69	4	4	–	1255	660	93,7	808	–	67,5
NU18/630M	630	780	69	4	4	672	2778	1193	250,1	810	–	76
NU28/630M	630	780	88	4	4	672	4514	1740	406,3	810	–	98
NU19/630E.M	630	850	100	6	6	683	4791	2406	431,1	740	–	167
NU29/630E.M	630	850	128	6	6	683	7400	3380	666	740	–	218
NU39/630E.M	630	850	165	6	6	683	9322	4045	839	740	–	277
NU10/630E.M	630	920	128	7,5	7,5	700	6397	3501	575,7	700	500	278
NU20/630E.M	630	920	170	7,5	7,5	705	10022	4791	902	690	–	399
NU30/630M	630	920	212	7,5	7,5	700	12966	5857	1166,9	690	–	495
NU31/630M	630	1030	315	7,5	7,5	727	17993	9177	1619,3	610	–	1070
06.63.01	640	790	56	4	4	–	1320	640	98,1	798	–	56
NU18/670M	670	820	69	4	4	712	2736	1163	246,2	770	–	80
NU28/670M	670	820	88	4	4	712	4359	1673	392,3	770	–	103
NU19/670E.M	670	900	103	6	6	728	5090	2482	458,1	700	–	192
NU29/670E.M	670	900	136	6	6	728	7802	3466	702,2	700	–	256
NU39/670E.M	670	900	170	6	6	728	9936	4183	894,3	700	–	319

► Weitere Ausführungen auf Anfrage | Other versions on request

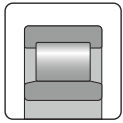

Zylinderrollenlager, einreihig
Cylindrical Roller Bearings, Single Row

Kurzzeichen	Abmessung						Tragzahl		Ermüdungs- grenzbel.	Grenz- drehzahl	Bezugs- drehzahl	Gewicht
							stat.	dyn.				
Code	Dimension						Load rating		Fatigue stress limit	Limiting speed	Reference speed	Weight
							stat.	dyn.				
	d mm	D mm	B mm	r _{s,min} mm	r _{1s,min} mm	F mm	C ₀ kN	C kN	C ₀ kN	n _g min ⁻¹	n _{th} min ⁻¹	kg
NU10/670E.M	670	980	136	7,5	7,5	746	7252	3928	652,7	700	500	337
NU20/670E.M	670	980	180	7,5	7,5	750	10735	5160	966,1	640	–	480
NU30/670M	670	980	230	7,5	7,5	745	14394	6368	1295,4	640	–	614
06.69.01	700	930	160	6	6	–	8910	3950	637	677	–	255,2
06.70.01	710	870	74	4	4	–	3350	1430	241,7	730	–	89,8
NU18/710M	710	870	74	4	4	753	3330	1415	299,7	730	–	96
07.71.01	710	870	74	4	4	–	3800	1550	274,2	730	–	89,8
NU28/710M	710	870	95	4	4	753	5440	2074	489,6	730	–	125
NU19/710E.M	710	950	106	6	6	769	5771	2796	519,4	660	–	217
NU29/710E.M	710	950	140	6	6	769	9234	4030	831,1	660	–	290
NU39/710E.M	710	950	180	6	6	769	10960	4616	986,4	660	–	371
NU10/710E.M	710	1030	140	7,5	7,5	791	7835	4111	705,1	600	400	378
NU20/710E.M	710	1030	185	7,5	7,5	793	11902	5589	1071,2	610	–	538
NU30/710M	710	1030	236	7,5	7,5	790	15822	6879	1424	610	–	687
NU18/750M	750	920	78	5	5	794	3590	1590	316,6	690	–	115
NU28/750M	750	920	100	5	5	795	5560	2082	500,4	690	–	150
06.75.01	750	1000	112	6	6	–	5100	2400	357	629	–	255
NU19/750E.M	750	1000	112	6	6	815	5953	2825	535,8	630	–	253
NU29/750E.M	750	1000	145	6	6	815	9525	4072	857,2	630	–	332
NU39/750E.M	750	1000	185	6	6	815	11979	4870	1078,1	630	–	422
NU10/750E.M	750	1090	150	7,5	7,5	830	8813	4583	793,1	600	400	483
NU20/750E.M	750	1090	195	7,5	7,5	835	13030	6226	1172,7	580	–	634
NU30/750M	750	1090	250	7,5	7,5	835	16039	7107	1443,5	580	–	811
06.79.01	800	980	82	5	5	–	2000	1048	139,2	640	–	113
NU18/800M	800	980	82	5	5	849	4265	1774	322,5	640	–	135
NU28/800M	800	980	106	5	5	849	7311	2699	552,9	640	–	178
NU19/800E.M	800	1060	115	6	6	866	6747	3170	510,2	600	–	286
NU29/800E.M	800	1060	150	6	6	866	10586	4507	800,6	600	–	377
NU39/800E.M	800	1060	195	6	6	866	13549	5457	1024,6	600	–	490
NU10/800E.M	800	1150	155	7,5	7,5	886	9744	5031	736,9	600	400	546
NU20/800E.M	800	1150	200	7,5	7,5	885	15216	7118	1150,7	550	–	708
NU30/800M	800	1150	258	7,5	7,5	885	19949	8538	1508,7	550	–	919
06.81.01	820	990	72	5	5	–	1810	920	125,4	635	–	111
NU18/850M	850	1030	82	5	5	899	4435	1803	335,4	610	–	142
NU28/850M	850	1030	106	5	5	895	7330	2671	554,3	610	–	185
NU19/850E.M	850	1120	118	6	6	919	7178	3332	542,8	560	–	323
NU29/850E.M	850	1120	155	6	6	919	11225	4721	848,9	560	–	429
NU39/850E.M	850	1120	200	6	6	919	14791	5847	1118,6	560	–	554
NU18/900M	900	1090	85	5	5	951	5067	2042	383,2	580	–	164
NU28/900M	900	1090	112	5	5	951	8360	3018	632,2	580	–	219
NU19/900E.M	900	1180	122	6	6	969	8576	3914	648,6	530	–	366

► Weitere Ausführungen auf Anfrage | Other versions on request

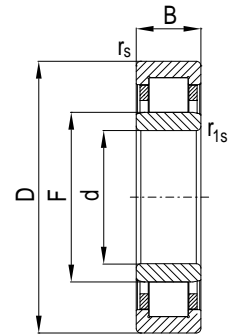

NU

Kurzzeichen	Abmessung						Tragzahl		Ermüdungs- grenzbel.	Grenz- drehzahl	Bezugs- drehzahl	Gewicht
							stat.	dyn.				
Code	Dimension						Load rating		Fatigue stress limit	Limiting speed	Reference speed	Weight
							stat.	dyn.				
	d mm	D mm	B mm	$r_{s, min}$ mm	$r_{1s, min}$ mm	F mm	C_0 kN	C kN	C_u kN	n_g min ⁻¹	n_{th} min ⁻¹	kg
NU29/900E.M	900	1180	165	6	6	969	12466	5248	942,8	530	–	497
NU39/900E.M	900	1180	206	6	6	969	15544	6240	1175,5	530	–	619
06.94.01	950	1150	90	5	5	–	2810	1200	186,2	550	–	170
NU18/950M	950	1150	90	5	5	1004	5319	2142	402,2	550	–	192
NU28/950M	950	1150	118	5	5	1004	9451	3349	714,8	550	–	257

► Weitere Ausführungen auf Anfrage | Other versions on request

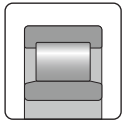

Zylinderrollenlager in Zollabmessungen
Cylindrical Roller Bearings In Inch Size

Kurzzeichen	Abmessung						Tragzahl		Drehzahlgrenze		Gewicht
							stat.	dyn.	Fett	Öl	
Code	Dimension						Load rating		Limiting speed		Weight
							stat.	dyn.	Grease	Oil	
	d inch	d mm	D mm	B mm	r _{s,min} mm	E mm	C ₀ kN	C kN	min ⁻¹	min ⁻¹	kg
LRJ3M	3	76,2	146	26,988	2,38	-	147	139	4900	6600	1,9
MRJ3E.M	3	76,2	177,8	39,688	3,97	-	275	258	4200	5700	5,2
LRJ3½.M	3½	88,9	165,1	28,575	3,17	-	189	168	4200	5700	2,6
MRJ3½E.M	3½	88,9	206,375	44,45	3,97	-	371	333	3500	4700	7,9
LRJ4M	4	101,6	184,15	31,75	3,17	-	219	173	2100	3600	3,6
MRJ4E.M	4	101,6	215,9	44,45	3,97	-	400	360	3100	4200	7,6
XLRJ4¼M	4¼	114,3	203,2	33,388	2,38	184,5	324	253	1900	3200	4,7
MRJ4¼E.M	4¼	107,95	222,25	44,45	3,97	195,8	400	360	3100	4200	8
LRJ4½M	4½	114,3	203,2	33,338	3,17	-	288	229	1900	3200	4,7
MRJ4½E.M	4½	114,3	238,125	50,8	4,76	-	529	472	2800	3800	11
XLRJ4¾M	4¾	120,65	165,1	22,225	2,38	154	133	92	2200	3700	1,3
MRJ4¾E.M	4¾	120,65	254	50,8	4,76	223,5	589	487	2600	3500	12,8
XLRJ5M	5	127	177,8	25,4	2,38	-	161	113	2100	3400	1,8
LRJ5M	5	127	228,6	34,925	3,17	200	369	281	1700	2800	6,5
LRJA5M	5	127	228,6	34,925	3,17	200	369	281	1700	2800	6,6
MRJA5E.M	5	127	254	50,8	4,76	227,5	605	510	2000	2600	12,6
XLRJ5½M	5½	139,7	190,5	25,4	2,38	177	175	117	1900	3100	2,4
LRJ5½M	5½	139,7	241,3	34,925	3,17	213,5	400	293	1600	2600	7
MRJA51/2E.M	5½	139,7	279,4	50,8	4,76	245,8	705	546	2300	3100	15,2
MRJA5 1/2 E.M	5½	139,7	279,4	50,8	4,76	245,8	705	546	2300	3100	15,2
XLRJ6M	6	152,4	203,2	25,4	2,38	190	198	127	1700	2800	2,1
LRJ6M	6	152,4	266,7	39,688	3,96	-	450	325	1300	2200	9,6
MRJ6E.M	6	152,4	304,8	57,15	4,76	-	822	674	2000	2700	20,2
XLRJ6½M	6½	165,1	222,25	28,575	3,17	-	211	131	1500	2600	3
LRJ6½M	6½	165,1	279,4	39,688	3,96	245	509	369	1100	2200	9,9
MRJ6½E.M	6½	165,1	330,2	63,5	4,76	-	920	740	1800	2400	26
MRJA6½E.M	6½	165,1	330,2	63,5	4,76	296	960	746	1800	2400	26,6
XLRJ7M	7	177,8	241,3	31,75	3,17	225,4	307	194	1200	2300	4,1
LRJ7M	7	177,8	304,8	44,45	3,17	271,1	680	482	950	1900	14,1
LRJA7M	7	177,8	304,8	44,45	3,17	271,1	680	482	950	1900	14,1
MRJ7E.M	7	177,8	342,9	63,5	4,76	301,6	950	747	900	1800	27,5
XLRJ7½M	7½	190,5	254	31,75	3,17	-	327	200	1100	2100	4,3
LRJ7½M	7½	190,5	317,5	44,45	3,96	-	712	508	1100	1800	14,7
MRJ7½E.M	7½	190,5	368,3	69,85	4,76	-	1140	884	1500	2100	34,8
XLRJ8M	8	203,2	273,05	34,925	3,17	-	373	230	1000	2000	5,7
LRJ8M	8	203,2	330,2	44,45	3,96	300,2	789	526	1000	1700	15,6
MRJ8E.M	8	203,2	381	69,85	4,76	-	1140	884	1550	2100	36,8
XLRJ8½M	8½	215,9	292,1	38,1	3,17	-	417	259	900	1800	7,1
LRJ8½M	8½	215,9	355,6	50,8	4,76	215,9	825	557	900	1500	20,6
LRJA8½M	8½	215,9	355,6	50,8	4,76	215,9	825	557	900	1500	20,6
MRJ8½E.M	8½	215,9	406,4	76,2	4,76	-	1280	959	850	1400	46,3

► Weitere Ausführungen auf Anfrage | Other versions on request

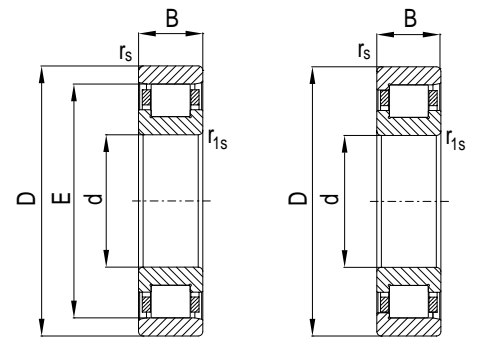

XLRJ, LRJ, MRJ..E

LRJA, MRJA..E

Kurzzeichen	Abmessung						Tragzahl		Drehzahlgrenze		Gewicht
							stat.	dyn.	Fett	Öl	
Code	Dimension						Load rating		Limiting speed		Weight
							stat.	dyn.	Grease	Oil	
	d inch	d mm	D mm	B mm	r _{s min} mm	E mm	C ₀ kN	C kN	min ⁻¹	min ⁻¹	kg
XLRJ9M	9	228,6	304,8	38,1	3,17	–	445	269	850	1700	7,5
LRJ9M	9	228,6	368,3	50,8	4,76	331,8	952	644	900	1500	21,9
MRJ9E.M	9	228,6	431,8	76,2	4,76	–	1460	1065	1300	1700	52,6
XLRJ9½M	9½	241,3	323,85	41,275	3,96	–	512	313	950	1600	9,3
LRJ9½M	9½	241,3	384,175	50,8	4,76	–	856	556	1400	1900	23,7
MRJ9½E.M	9½	241,3	457,2	82,55	4,76	–	1640	1230	1200	1600	63,1
XLRJ10M	10	254	336,55	41,275	3,96	–	523	310	900	1500	9,2
LRJ10M	10	254	400,05	50,8	4,76	–	1040	674	750	1300	25,2
MRJ10E.M	10	254	469,9	82,55	4,76	–	1650	1190	1100	1500	64,9
XLRJ10½M	10½	266,7	355,6	44,45	3,96	–	640	373	700	1400	11,8
LRJ10½M	10½	266,7	422,275	57,15	4,76	–	1020	671	1200	1600	30,8
MRJ10½E.M	10½	266,7	495,3	88,9	6,35	–	1870	1330	1000	1400	79,4
XLRJ11M	11	279,4	368,3	44,45	3,96	–	678	386	650	1300	12,4
LRJ11M	11	279,4	444,5	57,15	4,76	398,5	1110	706	1100	1500	35,5
MRJ11E.M	11	279,4	508	88,9	6,35	–	1880	1330	1000	1300	81,6
XLRJ11½M	11½	292,1	387,35	47,625	3,96	–	736	423	600	1200	15
LRJ11½M	11½	292,1	457,2	59,531	4,76	–	1310	839	1100	1400	38,3
XLRJ12M	12	304,8	406,4	50,8	4,76	382,3	836	477	550	1100	17,1
LRJ12M	12	304,8	469,9	66,675	4,76	–	1360	858	1000	1400	42,6
MRJ12E.M	12	304,8	546,1	95,25	4,76	–	2480	1720	900	1200	101
XLRJ13M	13	330,2	444,5	57,15	4,76	–	993	571	600	1000	24,7
LRJ13M	13	330,2	508	69,85	4,76	–	1680	1030	900	1200	54,4
XLRJ14M	14	355,6	469,9	57,15	4,76	–	998	564	550	950	25,4
LRJ14M	14	355,6	546,1	73,025	4,76	–	1190	1190	800	1100	65,3
XLRJ15M	15	381	508	63,5	4,76	–	1830	705	500	850	34,9
LRJ15M	15	381	571,5	76,2	4,76	–	1940	1220	750	1000	70,8

► Weitere Ausführungen auf Anfrage | Other versions on request

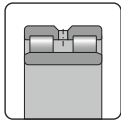

Zylinderrollenlager, zweireihig
Cylindrical Roller Bearings, Double Row

Kurzzeichen	Abmessung						Tragzahl		Ermüdungs- grenzbel.	Grenz- drehzahl	Gewicht
							stat.	dyn.			
Code	Dimension						Load rating		Fatigue stress limit	Limiting speed	Weight
							stat.	dyn.			
	d mm	D mm	B mm	r _{s min} mm	n _s mm	F _r E mm	C ₀ kN	C kN	C ₀ kN	n _g min ⁻¹	kg
24.60.01	60	95	44	1,1	–	–	190	125	25,5	7323	1,2
NNU4920M	100	140	40	1,1	6,5	113	253	128	36	4810	1,9
22.10.01	100	140	40	1,1	–	–	246	125	36	6300	2,1
NN3020M	100	150	37	1,5	6,5	137	265	157	37	4460	2,3
NNU4921M	105	145	40	1,1	6,5	118	261	130	32	4630	2
NN3021M	105	160	41	2	6,5	146	329	201	40	4170	3
NNU4922M	110	150	40	1,1	6,5	123	276	134	34	4460	2
NN3022M	110	170	45	2	6,5	155	384	232	47	3910	3,8
NNU4924M	120	165	45	1,1	6,5	134,5	341	175	42	4030	2,9
NN3024M	120	180	46	2	6,5	165	401	236	49	3680	4,1
NNU4926M	130	180	50	1,5	6,5	146	403	206	49	3680	3,8
NN3026M	130	200	52	2	9,5	182	502	296	61	3290	6,1
NNU4928M	140	190	50	1,5	6,5	156	430	213	53	3470	4,1
NN3028M	140	210	53	2	9,5	192	523	301	64	3130	6,5
NNU4930M	150	210	60	2	6,5	168,5	642	325	79	3130	6
NN3030M	150	225	56	2,1	9,5	206	595	338	73	2910	7,9
NNU4932M	160	220	60	2	6,5	178,5	666	329	82	2980	6,4
NN3032M	160	240	60	2,1	9,5	219	670	376	82	2720	9,6
NNU4934M	170	230	60	2	6,5	188,5	711	342	87	2840	6,7
NN3034M	170	260	67	2,1	9,5	236	823	459	101	2500	13,1
NNU4936M	180	250	69	2	9,5	202	944	450	116	2600	6,7
NN3036M	180	280	74	2,1	12,2	255	819	489	100	2310	17
NNU4938M	190	260	69	2	9,5	212	1006	467	123	2500	10,2
NN3038M	190	290	75	2,1	12,2	265	1098	603	134	2230	18,1
NNU4840M	200	250	50	1,5	6,5	216	601	240	74	2600	5,7
NNU4940M	200	280	80	2,1	12,2	225	1155	547	141	2310	14,5
NN3040M	200	310	82	2,1	12,2	282	1255	690	154	2080	23
NNU4844M	220	270	50	1,5	6,5	237	703	264	86	2400	6,2
NNU4944M	220	300	80	2,1	12,2	245	1234	564	151	2160	15,7
NN3044M	220	340	90	3	15	310	1558	849	191	1890	32,9
NNU4948M	240	320	80	2,1	12,2	265	1314	580	161	2020	16,8
NN3048M	240	360	92	3	15	333	1627	863	199	1790	36
NNU4852M	260	320	60	2	6,5	279,5	987	365	104	2020	10,6
NNU4952M	260	360	100	2,1	15	292	1983	870	209	1790	29,6
08.26.01	260	360	115	2,1	9,5	–	2545	1056	243	1780	37,5
NN3052M	260	400	104	4	15	364	2061	1090	218	1600	48
NNU4956M	280	380	100	2,1	15	312	2109	898	223	1690	31,4
NN3056M	280	420	106	4	15	384	2150	1109	227	1520	52
NNU4960M	300	420	118	3	17,7	339	2665	1156	281	1520	48,7
NN3060M	300	460	118	4	17,7	418	2585	1293	273	1390	71
NNU4864M	320	400	80	2,1	9,5	346	1889	716	200	1600	23

► Weitere Ausführungen auf Anfrage | Other versions on request

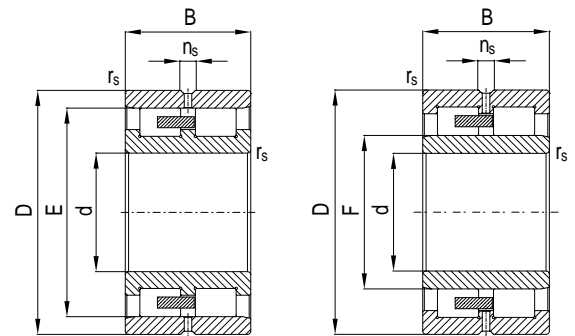

NN30

NNU40, NNU48, NNU49

Kurzzeichen	Abmessung						Tragzahl		Ermüdungs- grenzbel.	Grenz- drehzahl	Gewicht
							stat.	dyn.			
Code	Dimension						Load rating		Fatigue stress limit	Limiting speed	Weight
							stat.	dyn.			
	d mm	D mm	B mm	r _{s min} mm	n _s mm	F, E mm	C ₀ kN	C kN	C ₀ kN	n _g min ⁻¹	kg
NNU4964M	320	440	118	3	17,7	359	2838	1196	300	1450	53,6
NN3064M	320	480	121	4	17,7	438	2714	1372	287	1330	78
NNU4868M	340	420	80	2,1	9,5	366	1968	729	208	1520	24,2
NNU4968M	340	460	118	3	17,7	379	2929	1210	309	1390	56,3
NN3068M	340	520	133	5	17,7	473	3484	1730	368	1230	100
NNU4972M	360	480	118	3	17,7	399	3102	1248	328	1330	59,2
NN3072M	360	540	134	5	17,7	493	3273	1583	346	1180	105
NNU4072M	360	540	180	5	17,7	405	5675	2833	599	1180	140
NNU4976M	380	520	140	4	17,7	426	3971	1610	419	1230	87,5
NN3076M	380	560	135	5	17,7	513	3514	1705	371	1140	114
NNU4980M	400	540	140	4	17,7	446	4210	1665	445	1180	91,7
NNU4884M	420	520	100	2,1	15	451	2909	1018	307	1230	47,3
NNU4984M	420	560	140	4	17,7	466	4336	1685	458	1140	95,4
NN3084M	420	620	150	5	17,7	569	4561	2168	482	1020	156
NNU4988M	440	600	160	4	17,7	490	5298	2082	560	1060	133
NNU4992M	460	620	160	4	17,7	510	5607	2153	592	1020	138
NNU4996M	480	650	170	5	17,7	534	6106	2347	645	980	163
NN3096A.M	480	700	165	6	23,5	644	6061	2772	640	910	214
NNU48/500M	500	620	118	3	15	539	4040	1420	438	1020	80,5
NNU49/500M	500	670	170	5	17,7	554	6285	2378	664	950	169
NNU49/530M	530	710	180	5	17,7	585	8250	3064	742	890	201
NN30/530M	530	780	185	6	23,5	715	8115	3755	730	810	299
08.52.01	530	780	250	6	23,5	-	12200	5500	900	800	420
NNU49/560M	560	750	190	5	17,7	623	8860	3281	797	840	241
NNU49/600M	600	800	200	5	17,7	666	10249	3602	922	790	282
NNU49/630M	630	850	218	6	23,5	704	11393	4146	1025	740	359
NNU48/670M	670	820	150	4	17,7	722	6996	2177	630	770	171
NNU49/670M	670	900	230	6	23,5	738	13868	5110	1248	700	408
NNU48/710M	710	870	160	4	17,7	763	8287	2627	746	730	205
NNU49/710M	710	950	243	6	23,5	782	15893	5698	1430	660	489
08.79.01	800	980	180	5	17,7	-	10800	3350	752	640	293
NNU48/800M	800	980	180	5	17,7	856	11068	3392	837	640	293
NNU49/800M	800	1060	258	6	23,5	880	17620	6234	1332	600	626

► Weitere Ausführungen auf Anfrage | Other versions on request

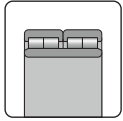

Zylinderrollenlager, mehrreihig
Cylindrical Roller Bearings, Multi Row

Kurzzeichen	Abmessung					Tragzahl		Ermüdungs- grenzbelastung	Grenzdrehzahl	Gewicht
						stat.	dyn.			
Code	Dimension					Load rating		Fatigue stress limit	Limiting speed	Weight
						stat.	dyn.			
	d mm	D mm	B mm	r _{s,min} mm	F/E mm	C ₀ kN	C kN	C ₀ kN	n _g min ⁻¹	kg
24.14.01	139,733	215	195	2,1	–	2625	1225	296,5	–	20,4
NNU6028E.M	140	210	125	2	157	1614	798	198	1380	15,2
NU6028E.M	140	210	125	2	157	1614	798	198	1380	15,2
NNU6030E.M	150	225	136	2,1	168,5	1828	888	224	1280	19,2
NU6030E.M	150	225	136	2,1	168,5	1828	888	224	1280	19,2
NNU6032E.M	160	240	145	2,1	179	2079	1017	255	1190	23,4
NU6032E.M	160	240	145	2,1	179	2079	1017	255	1190	23,4
NNU6034E.M	170	260	160	2,1	191	2443	1215	299	1110	31,2
NU6034E.M	170	260	160	2,1	191	2443	1215	299	1110	31,2
12.17.01	180	260	168	2,1	–	2620	1100	277	–	29,8
NNU6036E.M	180	280	180	2,1	204	2947	1470	361	1040	41,5
NU6036E.M	180	280	180	2,1	207	2947	1470	361	1040	41,5
NNU6038E.M	190	290	180	2,1	214	3111	1517	381	980	43,4
NU6038E.M	190	290	180	2,1	214	3111	1517	381	980	43,4
NNU6040E.M	200	310	200	2,1	227	3917	1856	480	930	56,9
NU6040E.M	200	310	200	2,1	227	3917	1856	480	930	56,9
12.19.07	200	310	230	2,1	–	3750	2010	380	–	63
NNU6044E.M	220	340	218	3	250	5053	2285	619	830	75,6
NU6044E.M	220	340	218	3	250	5053	2285	619	830	75,6
NNU6048E.M	240	360	218	3	270	5539	2409	678	750	81,1
NU6048E.M	240	360	218	3	270	5539	2409	678	750	81,1
NNU6052E.M	260	400	250	4	294	6756	3019	714	690	120
NU6052E.M	260	400	250	4	294	6756	3019	714	690	120
NNU6056E.M	280	420	250	4	314	7102	3093	750	630	127
NU6056E.M	280	420	250	4	316	7102	3093	750	630	140
NNU6060E.M	300	460	290	4	341	9319	3950	984	590	184
NU6060E.M	300	460	290	4	341	9319	3950	984	590	184
NNU6064E.M	320	480	290	4	361	9767	4044	1032	550	193
NU6064E.M	320	480	290	4	361	9767	4044	1032	550	193
NNU6068E.M	340	520	325	5	385	12078	5041	1276	510	257
NU6068E.M	340	520	325	5	385	12078	5041	1276	510	257
12.35.03	360	480	280	3	–	8310	3040	725	–	113,4
12.35.02	360	480	280	3	–	8310	3040	725	–	112
12.35.01	360	520	380	–	–	13150	4860	1130	–	275
NNU6072E.M	360	540	325	5	405	12651	5165	1336	480	269
NU6072E.M	360	540	325	5	405	12651	5165	1336	480	269
12.36.01	370	520	380	1,5	–	13000	4900	1114	–	180
NNU6076E.M	380	560	325	5	425	13223	5286	1397	450	280
NU6076E.M	380	560	325	5	425	13223	5286	1397	450	280
NNU6080E.M	400	600	355	5	449	14695	6091	1552	420	365
NU6080E.M	400	600	355	5	449	14695	6091	1552	420	365

► Weitere Ausführungen auf Anfrage | Other versions on request

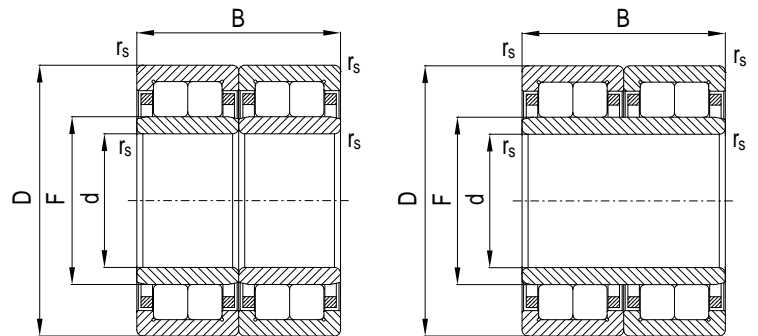

NNU60E

NU60E

Kurzzeichen	Abmessung					Tragzahl		Ermüdungs-grenzbelastung	Grenzdrehzahl	Gewicht
						stat.	dyn.			
Code	Dimension					Load rating		Fatigue stress limit	Limiting speed	Weight
						stat.	dyn.			
	d mm	D mm	B mm	r _{s min} mm	F/E mm	C ₀ kN	C kN	C _u kN	n _g min ⁻¹	kg
12.41.01	420	560	280	6	-	11135	3770	927	-	172
12.41.02	420	560	280	6	-	11135	3770	927	-	172
NNU6084E.M	420	620	355	5	469	15379	6246	1624	400	379
NU6084E.M	420	620	355	5	469	15379	6246	1624	400	379
NNU6088E.M	440	650	375	6	494	17438	6804	1842	380	445
NU6088E.M	440	650	375	6	494	17438	6804	1842	380	445
NNU6092E.M	460	680	400	6	514	19007	7549	2008	360	510
NU6092E.M	460	680	400	6	514	19007	7549	2008	360	510
NNU6096E.M	480	700	400	6	534	19845	7736	2096	350	537
NU6096E.M	480	700	400	6	534	19845	7736	2096	350	537
NNU60/500E.M	500	720	400	6	554	20684	7918	2185	330	576
NU60/500E.M	500	720	400	6	554	20684	7918	2185	330	576
NNU60/530E.M	530	780	450	6	590	24780	9746	2230	310	759
NNU60/560E.M	560	820	462	6	625	27077	10304	2437	290	857
NNU60/600E.M	600	870	488	6	665	29916	11382	2692	270	999
NNU60/630E.M	630	920	515	7,5	700	35140	13172	3163	250	1210
NNU60/670E.M	670	980	560	7,5	746	39457	14681	3551	240	1487
NNU60/710E.M	710	1030	580	7,5	791	45010	16029	4051	220	1695
NNU60/750E.M	750	1090	615	7,5	836	50052	17713	4505	210	2020
12.81.01	820	1130	800	6	-	68000	24200	4606	-	2540

► Weitere Ausführungen auf Anfrage | Other versions on request

Zylinderrollenlager, mehrreihig, Bolzenkäfig

Cylindrical Roller Bearings, Multi Row, Steel Pin Cage

Kurzzeichen	Abmessung					Tragzahl		Ermüdungs-grenzbelastung	Grenzdrehzahl	Gewicht
						sta.	dyn.			
Code	Dimension					Load rating		Fatigue stress limit	Limiting speed	Weight
						stat.	dyn.			
	d mm	D mm	B mm	r _{s min} mm	F/E mm	C ₀ kN	C kN	C _u kN	n _g min ⁻¹	kg
12.44.01	447,295	635,176	463,55	5	-	20700	9800	1673	-	488
12.49.01	500	710	480	5	-	23200	11200	1813	-	615
12.54.02	550	800	560	4	-	30940	16200	2340	-	952
12.55.01	560	820	600	4	-	33400	15850	2509	-	1109
12.64.01	650	900	650	7,5	-	42943	13674	3816	-	1236
12.67.01	680	980	640	4	-	45000	21200	3936	-	1695
12.70.01	710	1000	715	4	-	55265	25375	4779	-	1818
12.81.01	820	1130	800	6	-	68000	24200	4606	-	2540

► Weitere Ausführungen auf Anfrage | Other versions on request

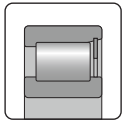

Zylinderrollenlager (vollrollig), einreihig
Cylindrical Roller Bearings (Full Complement), Single Row

Kurzzeichen	Abmessung						Tragzahl		Ermüdungs- grenzbel.	Grenz- drehzahl	Bezugs- drehzahl	Gewicht
							stat.	dyn.				
Code	Dimension						Load rating		Fatigue stress limit	Limiting speed	Reference speed	Weight
							stat.	dyn.				
	d mm	D mm	B mm	r _{s,min} mm	s mm	F/E mm	C ₀ kN	C kN	C _u kN	n _g min ⁻¹	n _{th} min ⁻¹	kg
NCF3008V	40	68	21	1	1,6	62	68	57	10	6000	4300	0,3
NCF2208V	40	80	23	1,1	1	70,9	68	60	10	5400	4300	0,6
NJG2308VH	40	90	33	1,5	2	51,1	158	146	22	4700	4900	1
NCF3009V	45	75	23	1	2	67,1	76	60	11	5400	4100	0,5
NCF2209V	45	85	23	1,1	1	74,4	88	75	13	5000	3800	0,6
NJG2309VH	45	100	36	1,5	3	56,1	173	156	24	4100	4100	1,4
NCF3010V	50	80	23	1	2	72	105	70	15	5000	3400	0,5
NCF2210V	50	90	23	1,1	1	81,5	114	94	16	4650	3000	0,7
NJG2310VH	50	110	40	2	3	60,7	220	200	31	3600	3600	1,8
NCF3011V	55	90	26	1,1	2	83,5	131	98	18	4450	3200	0,7
NCF2211V	55	100	25	1,5	1,5	88,8	136	112	19	4200	3100	0,9
NJG2311VH	55	120	43	2	3	67,1	260	234	37	3200	3200	2,3
NCF2912V	60	85	16	1	1	78,7	68	40	10	4450	2900	0,3
NCF3012V	60	95	26	1,1	2	86,7	138	101	19	4200	3000	0,7
NCF2212V	60	110	28	1,5	1,5	99,2	164	133	23	3800	2800	1,2
NJG2312VH	60	130	46	2,1	3	73,7	286	249	40	2900	2800	2,9
NCF2913V	65	90	16	1	0,5	83,4	71	43	10	4200	2700	0,3
NCF3013V	65	100	26	1,1	2	93	151	107	21	3950	2800	0,8
NCF2213V	65	120	31	1,5	1,5	106,3	195	155	27	3500	2600	1,6
NJG2313VH	65	140	48	2,1	3,5	80,7	357	304	50	2600	2500	3,6
NCF2914V	70	100	19	1	0,5	92,4	114	75	16	3800	2500	0,5
NCF3014V	70	110	30	1,1	1,5	100	180	127	25	3600	2700	1
NCF2214V	70	125	31	1,5	1,5	111,3	227	176	32	3300	2300	1,7
NJG2314VH	70	150	51	2,1	3,5	84,2	396	334	56	2400	2300	4,4
NCF2915V	75	105	19	1	1	97,6	121	78	17	3600	2300	0,6
NCF3015V	75	115	30	1,1	3	107,9	196	139	28	3400	2500	1,1
NCF2215V	75	130	31	1,5	1,5	115,8	266	206	36	3150	2200	1,8
NJG2315VH	75	160	55	2,1	3,5	91,2	474	393	67	2200	2100	5,3
NCF2916V	80	110	19	1	1	102,5	129	80	18	3400	2200	0,6
NCF3016V	80	125	34	1,1	4	117	235	164	33	3150	2400	1,5
NCF2216V	80	140	33	2	1,5	125,8	306	234	41	2950	2000	2,2
NJG2316VH	80	170	58	2,1	3,5	98,3	564	460	79	2000	1900	6,4
NCF2917V	85	120	22	1,1	1	109,7	162	101	23	3150	2100	0,9
NCF3017V	85	130	34	1,1	4	121	262	177	37	3000	2300	1,6
NCF2217V	85	150	36	2	1,5	133,2	349	264	47	2750	1900	2,8
NJG2317VH	85	180	60	3	4	107	615	487	87	1800	1800	7,4
NCF2918V	90	125	22	1,1	1	115,5	172	104	24	3000	2000	0,9
NCF3018V	90	140	37	1,5	4	130	303	211	43	2800	2200	2
NCF2218V	90	160	40	2	2,5	140,6	395	295	53	2600	1800	3,5
NJG2318VH	90	190	64	3	4	114,7	722	563	102	1800	1700	9
NCF2919V	95	130	22	1,1	1	121,1	181	123	25	2900	2000	0,9

► Weitere Ausführungen auf Anfrage | Other versions on request

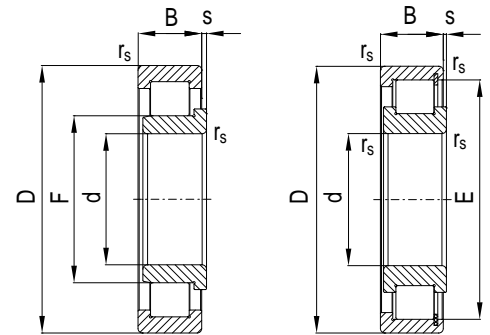

NJG

NCF

Kurzzeichen	Abmessung						Tragzahl		Ermüdungs- grenzbel.	Grenz- drehzahl	Bezugs- drehzahl	Gewicht
							stat.	dyn.				
Code	Dimension						Load rating		Fatigue stress limit	Limiting speed	Reference speed	Weight
							stat.	dyn.				
	d mm	D mm	B mm	r _{s,min} mm	s mm	F/E mm	C ₀ kN	C kN	C ₀ kN	n _g min ⁻¹	n _{th} min ⁻¹	kg
NCF3019V	95	145	37	1,5	4	135	300	207	42	2700	2100	2,1
NCF2219V	95	170	43	2,1	2,5	155,5	444	328	59	2450	1700	4,2
NJG2319VH	95	200	67	3	4	112,3	767	608	108	1700	1500	10,2
NCF2920V	100	140	24	1,1	1,5	128,3	221	130	31	2700	1800	1,2
NCF3020V	100	150	37	1,5	4	139,8	308	209	43	2600	2000	2,2
NCF2220V	100	180	46	2,1	2,5	163	536	384	75	2210	1700	5,1
NJG2320VH	100	215	73	3	4	119,3	906	705	127	1600	1400	13
NCF2922V	110	150	24	1,1	1	137,9	240	136	29	2490	1600	1,3
NCF3022V	110	170	45	2	5,5	156,3	397	274	49	2310	2000	3,7
NCF2222V	110	200	53	2,1	4	184,2	563	424	69	2090	1700	7,2
NJG2322VH	110	240	80	3	5	133,3	1122	861	137	1400	1200	17,5
NCF2924V	120	165	27	1,1	1,3	153,8	293	172	36	2270	1600	1,7
NCF3024V	120	180	46	2	5,5	167,7	435	289	53	2160	1800	4
NCF2224V	120	215	58	2,1	4	192,5	637	462	78	1930	1600	9,1
NJG2324VH	120	260	86	3	5	147,4	1248	963	153	1200	1100	22,5
NCF2926V	130	180	30	1,5	2	166,7	356	205	44	2090	1500	2,3
NCF3026V	130	200	52	2	5,5	184	616	414	75	1960	1600	5,8
NCF2226V	130	230	64	3	5	207,1	879	610	112	1800	1200	11
NJG2326VH	130	280	93	4	6	157,9	1445	1102	177	1000	1000	28
NCF2928V	140	190	30	1,5	2	175	378	211	46	1960	1400	2,5
NCF3028V	140	210	53	2	5,5	197,8	720	458	88	1850	1400	6,2
NCF2228V	140	250	68	3	5	221,9	1032	706	130	1660	1100	14,5
NJG2328VH	140	300	102	4	6,5	168,5	1657	1249	203	950	900	36
NCF1830V	150	190	20	1,1	1,5	179,5	213	116	27	1900	1400	1,3
NCF2930V	150	210	36	2	2,5	195	503	289	62	1800	1300	3,9
NCF3030V	150	225	56	2,1	7	208,3	705	467	86	1730	1400	7,5
NCF2230V	150	270	73	3	6	236,7	1199	810	150	1540	1000	19
NJG2330VH	150	320	108	4	6,5	182,5	2069	1520	253	900	800	43
NCF1832V	160	200	20	1,1	1,5	189	233	121	28	1800	1200	1,5
NCF2932V	160	220	36	2	2,5	205,2	534	298	65	1710	1200	4,2
NCF3032V	160	240	60	2,1	7	224,8	842	538	103	1620	1200	9,3
NCF2232V	160	290	80	3	6	266,3	1380	1097	182	1440	900	23
NJG2332VH	160	340	114	4	7	196,6	2158	1583	269	900	800	50
NCF1834V	170	215	22	2	1,5	204,5	272	149	33	1700	1200	1,8
NCF2934V	170	230	36	2	2,5	215,4	566	307	69	1620	1200	4,3
NCF3034V	170	260	67	2,1	7	243	1054	669	129	1510	1100	12,5
NCF2234V	170	310	86	4	7	281,1	1679	1097	206	1350	900	29
NJG2334VH	170	360	120	4	7	203,5	2458	1795	301	800	700	61
NCF1836V	180	225	22	1,1	1,5	215,2	277	141	34	1600	1100	2
NCF2936V	180	250	42	2	2,5	231,5	693	390	85	1510	1100	6,3
NCF3036V	180	280	74	2,1	7	260,2	1350	827	165	1410	1000	16,5

► Weitere Ausführungen auf Anfrage | Other versions on request

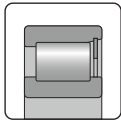

Zylinderrollenlager (vollrollig), einreihig
Cylindrical Roller Bearings (Full Complement), Single Row

Kurzzeichen	Abmessung						Tragzahl		Ermüdungs- grenzbel.	Grenz- drehzahl	Bezugs- drehzahl	Gewicht
							stat.	dyn.				
Code	Dimension						Load rating		Fatigue stress limit	Limiting speed	Reference speed	Weight
							stat.	dyn.				
	d mm	D mm	B mm	r _{s,min} mm	s mm	F/E mm	C ₀ kN	C kN	C ₀ kN	n _g min ⁻¹	n _{th} min ⁻¹	kg
NCF2236V	180	320	86	4	7	293,2	1781	1137	218	1330	800	30
NJG2336VH	180	380	126	4	9	221,7	2682	1899	329	700	600	72
NCF1838V	190	240	24	1,5	2	228,8	331	173	40	1500	1100	2,5
NCF2938V	190	260	42	2	2,5	243,5	736	403	90	1440	1000	6,8
NCF3038V	190	290	75	2,1	9	269,8	1328	809	163	1350	1000	17
NCF2238V	190	340	92	4	9	309	1970	1248	241	1270	800	36
NJG2338VH	190	400	132	5	9	224,6	3024	2156	370	700	600	81
NCF1840V	200	250	24	1,5	2	237,5	332	174	41	1400	1000	3,5
NCF2940V	200	280	48	2,1	3	260,8	956	527	117	1350	900	9,1
NCF3040V	200	310	82	2,1	9	287,8	1509	910	185	1270	900	23
NCF2240V	200	360	98	4	9	318,5	2247	1332	275	1210	700	45
NJG2340VH	200	420	138	5	9	238,7	3293	2362	403	670	560	92
NCF1844V	220	270	24	1,5	2	257,8	435	221	51	1200	900	3
NCF2944V	220	300	48	2,1	3,5	282,5	994	517	122	1250	900	10
NCF3044V	220	340	90	3	9	312,3	1820	1120	198	1160	800	30
NJG2344VH	220	460	145	5	9	267,6	4033	2806	485	600	500	118
NCF1848V	240	300	28	2	1,4	287,8	548	265	67	1100	800	4,5
NCF2948V	240	320	48	2,1	3	302,7	1077	539	132	1160	800	11
NCF3048V	240	360	92	3	11	335,3	1956	1142	240	1080	700	32
NJG2348VH	240	500	155	5	10	287,7	4442	3151	544	500	400	150
NCF1852V	260	320	28	2	1,8	307,2	561	275	59	1000	800	4,8
NCF2952V	260	360	60	2,1	3,5	333,2	1434	742	151	1050	700	19
NCF3052V	260	400	104	4	11	376,1	2597	1568	274	980	600	48
NCF1856V	280	350	33	2	3	334	735	367	78	950	700	7,5
NCF2956V	280	380	60	2,1	3,5	358,9	1711	870	181	980	600	20
NCF3056V	280	420	106	4	11	390,5	2976	1725	314	930	500	50
NCF1860V	300	380	38	2,1	3,5	363	885	438	93	850	700	11
NCF2960V	300	420	72	3	5	389,7	2199	1117	232	900	500	32
NCF3060V	300	460	118	4	14	433,8	3628	2076	383	850	500	70
NCF1864V	320	400	38	2,1	4,5	383	912	442	96	800	600	11
NCF2964V	320	440	72	3	5	410	2356	1164	249	850	500	33
NCF3064V	320	480	121	4	14	449,7	3657	2068	386	810	500	75
NCF1868V	340	420	38	2,1	4,5	401	980	460	103	750	500	11,5
NCF2968V	340	460	72	3	5	430,5	2475	1190	261	750	500	36
NCF3068V	340	520	133	5	16	485,6	4150	2370	396	800	500	100
NCF1872V	360	440	38	2,1	3	422	1043	490	110	700	500	12
NCF2972V	360	480	72	3	5	450,8	2613	1224	276	770	400	38
NCF3072V	360	540	134	5	13	502,8	4945	2650	522	720	400	108
NCF1876V	380	480	46	2,1	3,4	455,7	1343	629	142	670	500	20
NCF2976V	380	520	82	4	5	488	3266	1576	345	720	400	53
NCF1880V	400	500	46	2,1	3,5	471,7	1396	642	147	630	500	21

► Weitere Ausführungen auf Anfrage | Other versions on request

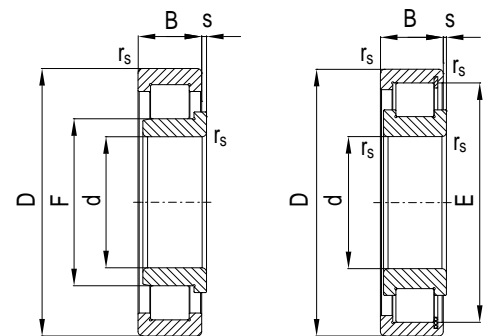

NJG

NCF

Kurzzeichen	Abmessung						Tragzahl		Ermüdungs- grenzbel.	Grenz- drehzahl	Bezugs- drehzahl	Gewicht
							stat.	dyn.				
Code	Dimension						Load rating		Fatigue stress limit	Limiting speed	Reference speed	Weight
							stat.	dyn.				
	d mm	D mm	B mm	r _{s,min} mm	s mm	F/E mm	C ₀ kN	C kN	C ₀ kN	n _g min ⁻¹	n _{th} min ⁻¹	kg
NCF2980V	400	540	82	4	5	511	3454	1623	365	690	400	55
NCF1884V	420	520	46	2,1	6	499	1454	657	145	600	400	22
NCF2984V	420	560	82	4	5	524	3551	1646	375	660	300	58
NCF1888V	440	540	46	2,1	6	516	1446	629	153	560	400	22
NCF2988V	440	600	95	4	7	565	4373	2011	462	620	300	82
NCF1892V	460	580	56	3	7	553	1723	845	190	530	400	35
NCF2992V	460	620	95	4	7	578,5	4400	2095	400	600	300	85
NCF1896V	480	600	56	3	7	573,5	1866	856	196	500	400	36
NCF2996V	480	650	100	5	7	605,5	5042	2289	533	570	300	100
NCF18/500V	500	620	56	3	7	594	2013	882	200	480	400	37
NCF29/500V	500	670	100	5	7	634,5	5204	2610	550	550	300	100
NCF18/530V	530	650	56	3	4,5	624,5	2318	1014	204	450	300	36,5
NCF29/530V	530	710	106	5	7	662,5	5604	2426	504	500	200	120
NCF18/560V	560	680	56	3	5	652	2418	1073	218	430	300	41
NCF29/560V	560	750	112	5	7	704,5	6581	2867	592	500	200	142
NCF18/600V	600	730	60	3	5,2	696	2613	1079	235	400	300	50
NCF29/600V	600	800	118	5	7	760,5	7375	3270	620	500	200	172
NCF18/630V	630	780	69	4	8	738,7	3148	1405	283	360	300	72
NCF29/630V	630	850	128	6	8	808	8575	3745	710	400	200	208
NCF18/670V	670	820	69	4	8	783	3477	1444	311	340	300	75
NCF29/670V	670	900	136	6	10	846	9000	3855	730	400	200	250
NCF18/710V	710	870	74	4	8	831	3730	1540	336	320	200	90
NCF29/710V	710	950	140	6	10	895	10200	4395	795	400	200	280
NCF18/750V	750	920	78	5	8,2	882	4580	1932	450	300	200	110
NCF29/750V	750	1000	145	6	11	936	11004	4592	990	400	100	320

► Weitere Ausführungen auf Anfrage | Other versions on request

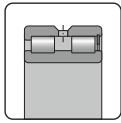

Zylinderrollenlager (vollrollig), zweireihig
Cylindrical Roller Bearings (Full Complement), Double Row

Kurzzeichen	Abmessung							Tragzahl		Ermüdungs- grenzbelastung
								stat.	dyn.	
Code	Dimension							Load rating		Fatigue stress limit
								stat.	dyn.	
	d mm	D mm	B mm	r _{s min} mm	s mm	n _s mm	E mm	C ₀ kN	C kN	C ₀ kN
NNC4912V	60	85	25	1	–	4,8	79	123	76	17
NNCF4912V	60	85	25	1	0,7	4,8	79	123	76	17
NNCL4912V	60	85	25	1	1	4,8	79	123	76	17
NNC5012V	60	95	46	1,1	–	–	86,7	280	200	39
NNCF5012V	60	95	46	1,1	1,5	–	86,7	280	200	39
NNCL5012V	60	95	46	1,1	1,5	–	86,7	280	200	39
NNC5013V	65	100	46	1,1	–	–	93,1	310	220	44
NNCF5013V	65	100	46	1,1	1,5	–	93,1	310	220	44
NNCL5013V	65	100	46	1,1	1,5	–	93,1	310	220	44
NNC4914V	70	100	30	1	–	4,8	92,2	168	95	24
NNCF4914V	70	100	30	1	0,7	4,8	92,2	168	95	24
NNCL4914V	70	100	30	1	1	4,8	92,2	168	95	24
NNC5014V	70	110	54	1,1	–	–	100,3	340	240	48
NNCF5014V	70	110	54	1,1	1,5	–	100,4	340	240	48
NNCL5014V	70	110	54	1,1	1,5	–	100,4	340	240	48
NNC5015V	75	115	54	1,1	–	–	107,9	390	260	55
NNCF5015V	75	115	54	1,1	1,5	–	107,9	390	260	55
NNCL5015V	75	115	54	1,1	1,5	–	107,9	390	260	55
NNC4916V	80	110	30	1	–	4,8	101,1	220	118	31
NNCF4916V	80	110	30	1	0,7	4,8	101,1	220	118	31
NNCL4916V	80	110	30	1	1	4,8	101,1	220	118	31
09.07.01	80	110	34	1	–	6,5	–	178	87,5	23,9
NNC5016V	80	125	60	1,1	–	–	117	450	290	63
NNCF5016V	80	125	60	1,1	1,5	–	117	450	290	63
NNCL5016V	80	125	60	1,1	1,5	–	117	450	290	63
NNC5017V	85	130	60	1,1	–	–	121,4	490	310	69
NNCF5017V	85	130	60	1,1	1,5	–	121,4	490	310	69
NNCL5017V	85	130	60	1,1	1,5	–	121,4	490	310	69
NNC4918V	90	125	35	1,1	–	4,8	115,5	267	144	39
NNCF4918V	90	125	35	1,1	0,7	4,8	115,5	267	144	39
NNCL4918V	90	125	35	1,1	1,5	4,8	115,5	267	144	39
NNC5018V	90	140	67	1,5	–	6,5	130,2	570	340	80
NNCF5018V	90	140	67	1,5	4	6,5	130,2	570	340	80
NNCL5018V	90	140	67	1,5	4	6,5	130,2	570	340	80
NNC5019V	95	145	67	1,5	–	–	135	630	370	89
NNCF5019V	95	145	67	1,5	1,5	–	135	630	370	89
NNCL5019V	95	145	67	1,5	1,5	–	135	630	370	89
NNC4920V	100	140	40	1,1	–	6,5	130	324	174	49
NNCF4920V	100	140	40	1,1	0,7	6,5	130	324	174	49
NNCL4920V	100	140	40	1,1	2	6,5	130	324	174	49
NNC5020V	100	150	67	1,5	–	–	139,7	660	410	93

► Weitere Ausführungen auf Anfrage | Other versions on request

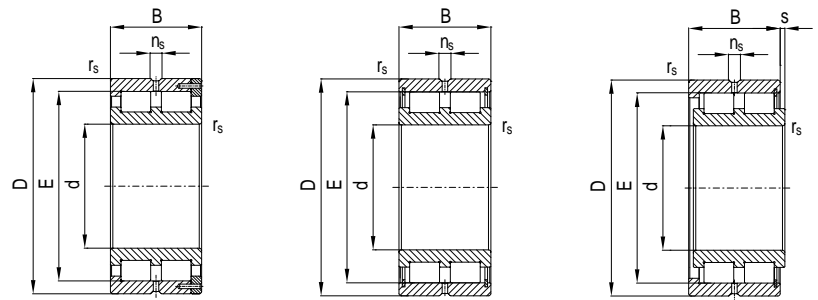

NNC

NNCL

NNCF

Grenzdrehzahl	Bezugsdrehzahl	Gewicht
Limiting speed	Reference speed	Weight
n_g min ⁻¹	n_{th} min ⁻¹	kg
4480	3160	0,5
4480	3160	0,5
4480	3160	0,5
4150	3020	1,2
4150	3020	1,2
4150	3020	1,2
3830	2770	1,3
3830	2770	1,3
3830	2770	1,3
3850	2650	0,8
3850	2650	0,8
3850	2650	0,8
3550	2570	1,8
3550	2570	1,8
3550	2570	1,8
3300	2390	1,9
3300	2390	1,9
3300	2390	1,9
3370	2270	0,9
3370	2270	0,9
3370	2270	0,9
6225	-	1,1
3090	2230	2,6
3090	2230	2,6
3090	2230	2,6
2910	2100	2,7
2910	2100	2,7
2910	2100	2,7
3000	1980	1,3
3000	1980	1,3
3000	1980	1,3
2740	1980	3,6
2740	1980	3,6
2740	1980	3,6
2590	1870	3,7
2590	1870	3,7
2590	1870	3,7
2710	1750	1,9
2710	1750	1,9
2710	1750	1,9
2460	1770	3,9

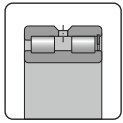

Zylinderrollenlager (vollrollig), zweireihig
Cylindrical Roller Bearings (Full Complement), Double Row

Kurzzeichen	Abmessung							Tragzahl		Ermüdungs- grenzbelastung
								stat.	dyn.	
Code	Dimension							Load rating		Fatigue stress limit
								stat.	dyn.	
	d mm	D mm	B mm	r _{s min} mm	s mm	n _s mm	E mm	C ₀ kN	C kN	C ₀ kN
NNCF5020V	100	150	67	1,5	1,5	–	139,8	660	410	93
NNCL5020V	100	150	67	1,5	1,5	–	139,8	660	410	93
NNC4922V	110	150	40	1,1	–	6,5	138,6	392	208	52
NNCF4922V	110	150	40	1,1	3	6,5	138,6	392	208	52
NNCL4922V	110	150	40	1,1	3	6,5	138,6	392	208	52
NNC5022V	110	170	80	2	–	–	156,1	830	480	102
NNCF5022V	110	170	80	2	2	–	156,3	830	480	102
NNCL5022V	110	170	80	2	2	–	156,3	830	480	102
NNC4924V	120	165	45	1,1	–	6,5	153,9	470	245	62
NNCF4924V	120	165	45	1,1	3	6,5	153,9	470	245	62
NNCL4924V	120	165	45	1,1	3	6,5	153,9	470	245	62
NNC5024V	120	180	80	2	–	6,5	167,7	950	560	116
NNCF5024V	120	180	80	2	2	6,5	167,6	950	560	116
NNCL5024V	120	180	80	2	2	6,5	167,6	950	560	116
NNC4926V	130	180	50	1,5	–	6,5	165,8	557	285	72
NNCF4926V	130	180	50	1,5	2	6,5	165,8	557	285	72
NNCL4926V	130	180	50	1,5	4	6,5	165,8	557	285	72
NNC5026V	130	200	95	2	–	–	183,8	1220	650	149
NNCF5026V	130	200	95	2	2	–	183,8	1220	650	149
NNCL5026V	130	200	95	2	2	–	183,8	1220	650	149
NNC4828V	140	175	35	1,1	–	–	166,5	420	190	51
NNCF4828V	140	175	35	1,1	1	–	166,5	420	190	51
NNCL4828V	140	175	35	1,1	2,2	–	166,5	420	190	51
NNC4928V	140	190	50	1,5	–	6,5	176,1	654	329	84
NNCF4928V	140	190	50	1,5	2	6,5	176,1	654	329	84
NNCL4928V	140	190	50	1,5	4	6,5	176,1	654	329	84
NNC5028V	140	210	95	2	–	–	198	1370	760	168
NNCF5028V	140	210	95	2	2	–	198	1370	760	168
NNCL5028V	140	210	95	2	2	–	198	1370	760	168
NNC4830V	150	190	40	2	–	6,5	178,8	490	210	60
NNCF4830V	150	190	40	2	2	6,5	178,8	490	210	60
NNCL4830V	150	190	40	2	2	6,5	178,8	490	210	60
NNC4930V	150	210	60	2	–	6,5	191,7	761	376	97
NNCF4930V	150	210	60	2	2	6,5	191,7	761	376	97
NNCL4930V	150	210	60	2	4	6,5	191,7	761	376	97
NNC5030V	150	225	100	2,1	–	6,5	206,8	1510	870	185
NNCF5030V	150	225	100	2,1	2	6,5	206,8	1510	870	185
NNCL5030V	150	225	100	2,1	2	6,5	206,8	1510	870	185
NNC4832V	160	200	40	1,1	–	6,5	186,9	550	240	67
NNCF4832V	160	200	40	1,1	2	6,5	186,9	550	240	67
NNCL4832V	160	200	40	1,1	2	6,5	186,9	550	240	67

► Weitere Ausführungen auf Anfrage | Other versions on request

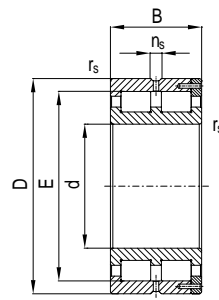

NNC

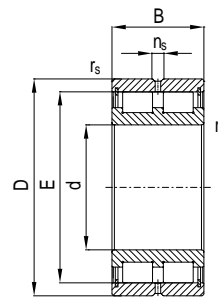

NNCL

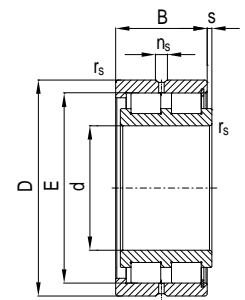

NNCF

Grenzdrehzahl	Bezugsdrehzahl	Gewicht
Limiting speed	Reference speed	Weight
n_g min ⁻¹	n_{th} min ⁻¹	kg
2460	1770	3,9
2460	1770	3,9
2460	1570	2,1
2460	1570	2,1
2460	1570	2,1
2230	1600	6,3
2230	1600	6,3
2230	1600	6,3
2260	1420	2,9
2260	1420	2,9
2260	1420	2,9
2040	1460	6,7
2040	1460	6,7
2040	1460	6,7
2090	1290	3,9
2090	1290	3,9
2090	1290	3,9
1880	1350	10,4
1880	1350	10,4
1880	1350	10,4
2050	1450	1,9
2050	1450	1,9
2050	1450	1,9
1940	1190	4,2
1940	1190	4,2
1940	1190	4,2
1740	1250	10,9
1740	1250	10,9
1740	1250	10,9
1920	1330	2,8
1920	1330	2,8
1920	1330	2,8
1810	1100	6,7
1810	1100	6,7
1810	1100	6,7
1620	1160	13,2
1620	1160	13,2
1620	1160	13,2
1800	1220	3,1
1800	1220	3,1
1800	1220	3,1

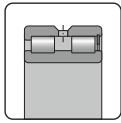

Zylinderrollenlager (vollrollig), zweireihig
Cylindrical Roller Bearings (Full Complement), Double Row

Kurzzeichen	Abmessung							Tragzahl		Ermüdungs- grenzbelastung
								stat.	dyn.	
Code	Dimension							Load rating		Fatigue stress limit
								stat.	dyn.	
	d mm	D mm	B mm	r _{s min} mm	s mm	n _s mm	E mm	C ₀ kN	C kN	C ₀ kN
NNC4932V	160	220	60	2	–	6,5	204,2	877	425	111
NNCF4932V	160	220	60	2	4	6,5	204,2	877	425	111
NNCL4932V	160	220	60	2	4	6,5	204,2	877	425	111
NNC5032V	160	240	109	2,1	–	–	224,8	1700	990	208
NNCF5032V	160	240	109	2,1	2	–	224,8	1700	990	208
NNCL5032V	160	240	109	2,1	2	–	224,8	1700	990	208
NNC4834V	170	215	45	1,1	–	6,5	201,9	620	260	76
NNCF4834V	170	215	45	1,1	2	6,5	201,9	620	260	76
NNCL4834V	170	215	45	1,1	3	6,5	201,9	620	260	76
NNC4934V	170	230	60	2	–	6,5	212,2	1000	478	125
NNCF4934V	170	230	60	2	2	6,5	212,2	1000	478	125
NNCL4934V	170	230	60	2	4	6,5	212,2	1000	478	125
NNC5034V	170	260	122	2,1	–	–	243	2080	1120	255
NNCF5034V	170	260	122	2,1	2	–	243	2080	1120	255
NNCL5034V	170	260	122	2,1	2	–	243	2080	1120	255
NNC4836V	180	225	45	1,1	–	6,5	211,4	700	290	86
NNCF4836V	180	225	45	1,1	3	6,5	211,4	700	290	86
NNCL4836V	180	225	45	1,1	3	6,5	211,4	700	290	86
NNC4936V	180	250	69	2	–	9,5	230,8	1140	534	141
NNCF4936V	180	250	69	2	3	9,5	230,8	1140	534	141
NNCL4936V	180	250	69	2	4	9,5	230,8	1140	534	141
NNC5036V	180	280	136	2,1	–	–	260,2	2390	1250	293
NNCF5036V	180	280	136	2,1	2,5	–	260,2	2390	1250	293
NNCL5036V	180	280	136	2,1	2,5	–	260,2	2390	1250	293
NNC4838V	190	240	50	1,5	–	6,5	225,4	780	320	96
NNCF4838V	190	240	50	1,5	3	6,5	225,4	780	320	96
NNCL4838V	190	240	50	1,5	4	6,5	225,4	780	320	96
NNC4938V	190	260	69	2	–	9,5	241,3	1280	592	157
NNCF4938V	190	260	69	2	4	9,5	241,3	1280	592	157
NNCL4938V	190	260	69	2	4	9,5	241,3	1280	592	157
NNC5038V	190	290	136	2,1	–	–	269,8	2570	1390	315
NNCF5038V	190	290	136	2,1	2,5	–	269,8	2570	1390	315
NNCL5038V	190	290	136	2,1	2,5	–	269,8	2570	1390	315
NNC4840V	200	250	50	1,5	–	6,5	236	860	350	105
NNCF4840V	200	250	50	1,5	4	6,5	236	860	350	105
NNCL4840V	200	250	50	1,5	4	6,5	236	860	350	105
NNC4940V	200	280	80	2,1	–	12,2	260,1	1420	653	174
NNCF4940V	200	280	80	2,1	4	12,2	260,1	1420	653	174
NNCL4940V	200	280	80	2,1	5	12,2	260,1	1420	653	174
NNC5040V	200	310	150	2,1	–	–	287,8	2930	1540	359
NNCF5040V	200	310	150	2,1	3	–	287,8	2930	1540	359

► Weitere Ausführungen auf Anfrage | Other versions on request

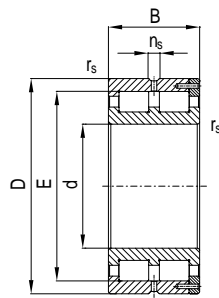

NNC

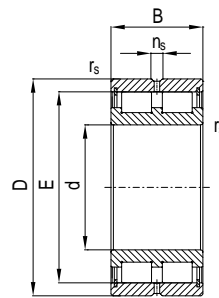

NNCL

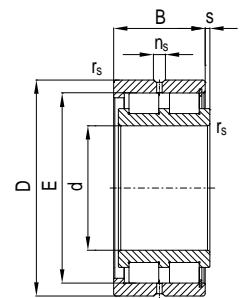

NNCF

Grenzdrehzahl	Bezugsdrehzahl	Gewicht
Limiting speed	Reference speed	Weight
n_g min ⁻¹	n_{th} min ⁻¹	kg
1700	1020	7
1700	1020	7
1700	1020	7
1520	1080	16
1520	1080	16
1520	1080	16
1690	1130	4,1
1690	1130	4,1
1690	1130	4,1
1600	950	7,5
1600	950	7,5
1600	950	7,5
1430	1020	22,4
1430	1020	22,4
1430	1020	22,4
1600	1050	4,2
1600	1050	4,2
1600	1050	4,2
1510	890	10,5
1510	890	10,5
1510	890	10,5
1350	960	29,8
1350	960	29,8
1350	960	29,8
1510	980	5,7
1510	980	5,7
1510	980	5,7
1440	830	11
1440	830	11
1440	830	11
1270	910	30,1
1270	910	30,1
1270	910	30,1
1440	910	5,7
1440	910	5,7
1440	910	5,7
1370	790	15,3
1370	790	15,3
1370	790	15,3
1210	860	41,5
1210	860	41,5

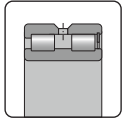

Zylinderrollenlager (vollrollig), zweireihig
Cylindrical Roller Bearings (Full Complement), Double Row

Kurzzeichen	Abmessung							Tragzahl		Ermüdungs- grenzbelastung
								stat.	dyn.	
Code	Dimension							Load rating		Fatigue stress limit
								stat.	dyn.	
	d mm	D mm	B mm	r _{s min} mm	s mm	n _s mm	E mm	C ₀ kN	C kN	C ₀ kN
NNCL5040V	200	310	150	2,1	3	–	287,8	2930	1540	359
09.19.01	200	342	140	3	–	12,2	–	2470	1520	246
NNC4844V	220	270	50	1,5	–	6,5	257,1	1040	410	127
NNCF4844V	220	270	50	1,5	4	6,5	257,1	1040	410	127
NNCL4844V	220	270	50	1,5	4	6,5	257,1	1040	410	127
NNC4944V	220	300	80	2,1	–	12,2	276,9	1730	783	211
NNCF4944V	220	300	80	2,1	5	12,2	276,9	1730	783	211
NNCL4944V	220	300	80	2,1	5	12,2	276,9	1730	783	211
NNC5044V	220	340	160	3	–	–	312,3	3500	1850	429
NNCF5044V	220	340	160	3	3	–	312,3	3500	1850	429
NNCL5044V	220	340	160	3	3	–	312,3	3500	1850	429
NNC4848V	240	300	60	2	–	6,5	282,4	1240	480	142
NNCF4848V	240	300	60	2	4	6,5	282,4	1240	480	142
NNCL4848V	240	300	60	2	4	6,5	282,4	1240	480	142
NNC4948V	240	320	80	2,1	–	12,2	299,8	2060	924	252
NNCF4948V	240	320	80	2,1	4	12,2	299,8	2060	924	252
NNCL4948V	240	320	80	2,1	5	12,2	299,8	2060	924	252
NNC5048V	240	360	160	3	–	–	335,6	3970	2160	486
NNCF5048V	240	360	160	3	3	–	335,6	3970	2160	486
NNCL5048V	240	360	160	3	3	–	335,6	3970	2160	486
NNC4852V	260	320	60	2	–	6,5	304,8	1460	560	154
NNCF4852V	260	320	60	2	4	6,5	304,8	1460	560	154
NNCL4852V	260	320	60	2	4	6,5	304,8	1460	560	154
NNC4952V	260	360	100	2,1	–	15	331	2430	1070	256
NNCF4952V	260	360	100	2,1	4	15	331	2430	1070	256
NNCL4952V	260	360	100	2,1	6	15	331	2430	1070	256
NNC5052V	260	400	190	4	–	–	376,1	4920	2460	520
NNCF5052V	260	400	190	4	5	–	376,1	4920	2460	520
NNCL5052V	260	400	190	4	5	–	376,1	4920	2460	520
NNC4856V	280	350	69	2	–	9,5	332,9	1690	630	179
NNCF4856V	280	350	69	2	4	9,5	332,9	1690	630	179
NNCL4856V	280	350	69	2	4	9,5	332,9	1690	630	179
NNC4956V	280	380	100	2,1	–	15	353,4	2820	1230	298
NNCF4956V	280	380	100	2,1	4	15	353,4	2820	1230	298
NNCL4956V	280	380	100	2,1	6	15	353,4	2820	1230	298
NNC5056V	280	420	190	4	–	–	391,1	5400	2720	570
NNCF5056V	280	420	190	4	5	–	391,1	5400	2720	570
NNCL5056V	280	420	190	4	5	–	391,1	5400	2720	570
NNC4860V	300	380	80	2,1	–	9,5	357,3	1940	710	205
NNCF4860V	300	380	80	2,1	6	9,5	357,3	1940	710	205
NNCL4860V	300	380	80	2,1	6	9,5	357,3	1940	710	205

► Weitere Ausführungen auf Anfrage | Other versions on request

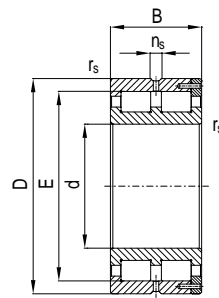

NNC

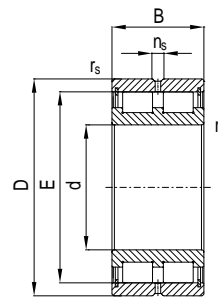

NNCL

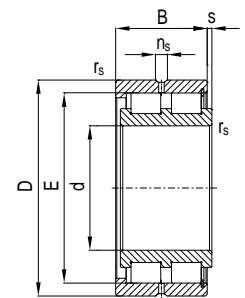

NNCF

Grenzdrehzahl	Bezugsdrehzahl	Gewicht
Limiting speed	Reference speed	Weight
n_g min ⁻¹	n_{th} min ⁻¹	kg
1210	860	41,5
1875	–	47,1
1310	810	6,2
1310	810	6,2
1310	810	6,2
1240	700	17
1240	700	17
1240	700	17
1100	780	51,8
1100	780	51,8
1100	780	51,8
1200	720	10
1200	720	10
1200	720	10
1140	640	18
1140	640	18
1140	640	18
1000	710	55,3
1000	710	55,3
1000	710	55,3
1110	650	10,6
1110	650	10,6
1110	650	10,6
1050	580	31,2
1050	580	31,2
1050	580	31,2
920	650	82,5
920	650	82,5
920	650	82,5
1030	590	15,6
1030	590	15,6
1030	590	15,6
980	530	33
980	530	33
980	530	33
850	600	89,6
850	600	89,6
850	600	89,6
960	540	23
960	540	23
960	540	23

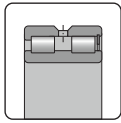

Zylinderrollenlager (vollrollig), zweireihig
Cylindrical Roller Bearings (Full Complement), Double Row

Kurzzeichen	Abmessung								Tragzahl		Ermüdungs- grenzbelastung
									stat.	dyn.	
	Code	Dimension								Load rating	
stat.										dyn.	
d mm		D mm	B mm	r _{s min} mm	s mm	n _s mm	E mm	C ₀ kN	C kN	C ₀ kN	
NNC4960V	300	420	118	3	–	17,7	385,5	3250	1400	343	
NNCF4960V	300	420	118	3	6	17,7	385,5	3250	1400	343	
NNCL4960V	300	420	118	3	6	17,7	385,5	3250	1400	343	
NNC4864V	320	400	80	2,1	–	9,5	380,3	2210	800	233	
NNCF4864V	320	400	80	2,1	6	9,5	380,3	2210	800	233	
NNCL4864V	320	400	80	2,1	6	9,5	380,3	2210	800	233	
NNC4964V	320	440	118	3	–	17,7	403,4	3700	1580	391	
NNCF4964V	320	440	118	3	6	17,7	403,4	3700	1580	391	
NNCL4964V	320	440	118	3	6	17,7	403,4	3700	1580	391	
NNC4868V	340	420	80	2,1	–	9,5	397,5	2490	890	263	
NNCF4868V	340	420	80	2,1	6	9,5	397,5	2490	890	263	
NNCL4868V	340	420	80	2,1	6	9,5	397,5	2490	890	263	
NNC4968V	340	460	118	3	–	17,7	430,2	4190	1760	442	
NNCF4968V	340	460	118	3	6	17,7	430,2	4190	1760	442	
NNCL4968V	340	460	118	3	6	17,7	430,2	4190	1760	442	
NNC4872V	360	440	80	2,1	–	9,5	421,7	2790	980	295	
NNCF4872V	360	440	80	2,1	6	9,5	421,7	2790	980	295	
NNCL4872V	360	440	80	2,1	6	9,5	421,7	2790	980	295	
NNC4972V	360	480	118	3	–	17,7	448	4700	1950	497	
NNCF4972V	360	480	118	3	6	17,7	448	4700	1950	497	
NNCL4972V	360	480	118	3	6	17,7	448	4700	1950	497	
NNC4876V	380	480	100	2,1	–	12,2	456,4	3650	1300	328	
NNCF4876V	380	480	100	2,1	6	12,2	456,4	3650	1300	328	
NNCL4876V	380	480	100	2,1	6	12,2	456,4	3650	1300	328	
NNC4976V	380	520	140	4	–	17,7	481,4	5250	2150	555	
NNCF4976V	380	520	140	4	7	17,7	481,4	5250	2150	555	
NNCL4976V	380	520	140	4	7	17,7	481,4	5250	2150	555	
NNC4880V	400	500	100	2,1	–	12,2	471	3750	1320	363	
NNCF4880V	400	500	100	2,1	6	12,2	471	3750	1320	363	
NNCL4880V	400	500	100	2,1	6	12,2	471	3750	1320	363	
NNC4980V	400	540	140	4	–	17,7	502	5830	2350	616	
NNCF4980V	400	540	140	4	7	17,7	502	5830	2350	616	
NNCL4980V	400	540	140	4	7	17,7	502	5830	2350	616	
NNC4884V	420	520	100	2,1	–	15	493,1	4000	1350	400	
NNCF4884V	420	520	100	2,1	6	15	493,1	4000	1350	400	
NNCL4884V	420	520	100	2,1	6	15	493,1	4000	1350	400	
NNC4984V	420	560	140	4	–	17,7	522,4	6440	2570	680	
NNCF4984V	420	560	140	4	7	17,7	522,4	6440	2570	680	
NNCL4984V	420	560	140	4	7	17,7	522,4	6440	2570	680	
NNC4888V	440	540	100	2,1	–	15	515,1	4200	1400	439	
NNCF4888V	440	540	100	2,1	6	15	515,1	4200	1400	439	

► Weitere Ausführungen auf Anfrage | Other versions on request

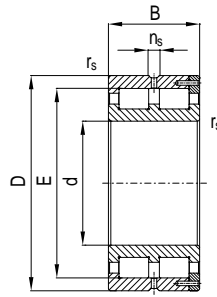

NNC

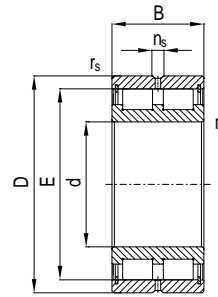

NNCL

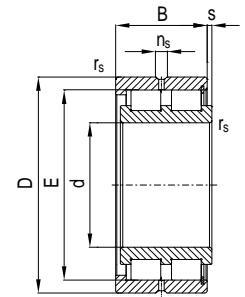

NNCF

Grenzdrehzahl	Bezugsdrehzahl	Gewicht
Limiting speed	Reference speed	Weight
n_g min ⁻¹	n_{th} min ⁻¹	kg
910	490	52
910	490	52
910	490	52
900	500	24,5
900	500	24,5
900	500	24,5
860	460	55
860	460	55
860	460	55
850	460	25,5
850	460	25,5
850	460	25,5
810	430	60
810	430	60
810	430	60
800	430	27
800	430	27
800	430	27
760	400	62
760	400	62
760	400	62
760	400	46
760	400	46
760	400	46
720	370	92
720	370	92
720	370	92
720	370	48
720	370	48
720	370	48
690	350	96
690	350	96
690	350	96
690	350	50
690	350	50
690	350	50
660	330	100
660	330	100
660	330	100
660	330	52
660	330	52

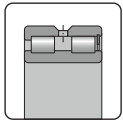

Zylinderrollenlager (vollrollig), zweireihig
Cylindrical Roller Bearings (Full Complement), Double Row

Kurzzeichen	Abmessung							Tragzahl		Ermüdungs- grenzbelastung
								stat.	dyn.	
Code	Dimension							Load rating		Fatigue stress limit
								stat.	dyn.	
	d mm	D mm	B mm	r _{s min} mm	s mm	n _s mm	E mm	C ₀ kN	C kN	C ₀ kN
NNCL4888V	440	540	100	2,1	6	15	515,1	4200	1400	439
NNC4988V	440	600	160	4	–	17,7	559,8	7080	2790	748
NNCF4988V	440	600	160	4	7	17,7	559,8	7080	2790	748
NNCL4988V	440	600	160	4	7	17,7	559,8	7080	2790	748
NNC4892V	460	580	118	3	–	15	543,9	4550	1540	481
NNCF4892V	460	580	118	3	7	15	543,9	4550	1540	481
NNCL4892V	460	580	118	3	7	15	543,9	4550	1540	481
NNC4992V	460	620	160	4	–	17,7	584	7750	3010	818
NNCF4992V	460	620	160	4	7	17,7	584	7750	3010	818
NNCL4992V	460	620	160	4	7	17,7	584	7750	3010	818
NNC4896V	480	600	118	3	–	15	565,1	4950	1630	513
NNCF4896V	480	600	118	3	7	15	565,1	4950	1630	513
NNCL4896V	480	600	118	3	7	15	565,1	4950	1630	513
NNC4996V	480	650	170	5	–	17,7	602	8450	3240	872
NNCF4996V	480	650	170	5	8	17,7	602	8450	3240	872
NNCL4996V	480	650	170	5	8	17,7	602	8450	3240	872
NNC48/500V	500	620	118	3	–	15	583,8	5370	1750	532
NNCF48/500V	500	620	118	3	7	15	583,8	5370	1750	532
NNCL48/500V	500	620	118	3	7	15	583,8	5370	1750	532
NNC49/500V	500	670	170	5	–	17,7	627,5	9180	3480	914
NNCF49/500V	500	670	170	5	8	17,7	627,5	9180	3480	914
NNCL49/500V	500	670	170	5	8	17,7	627,5	9180	3480	914
09.50.01	510	720	210	5	–	17,7	–	10000	4100	798
NNC48/530V	530	650	118	3	–	15	615	6030	1940	543
NNCF48/530V	530	650	118	3	7	15	615	6030	1940	543
NNCL48/530V	530	650	118	3	7	15	615	6030	1940	543
NNC49/530V	530	710	180	5	–	17,7	659	10340	3850	930
NNCF49/530V	530	710	180	5	8	17,7	659	10340	3850	930
NNCL49/530V	530	710	180	5	8	17,7	659	10340	3850	930
NNC49/560V	560	750	190	5	–	17,7	611,5	11560	4230	1040
NNCF49/560V	560	750	190	5	7	17,7	611,5	11560	4230	1040
NNCL49/560V	560	750	190	5	9,5	17,7	611,5	11560	4230	1040
NNC49/600V	600	800	200	5	–	17,7	753	13310	4770	1200
NNCF49/600V	600	800	200	5	7	17,7	753	13310	4770	1200
NNCL49/600V	600	800	200	5	10	17,7	753	13310	4770	1200
NNC49/630V	630	850	218	6	–	23,5	798	14700	5190	1320
NNCF49/630V	630	850	218	6	8,5	23,5	798	14700	5190	1320
NNCL49/630V	630	850	218	6	11	23,5	798	14700	5190	1320
NNC49/670V	670	900	230	6	–	23,5	848	16560	5770	1500
NNCF49/670V	670	900	230	6	9	23,5	848	16560	5770	1500
NNCL49/670V	670	900	230	6	11,5	23,5	848	16560	5770	1500

► Weitere Ausführungen auf Anfrage | Other versions on request

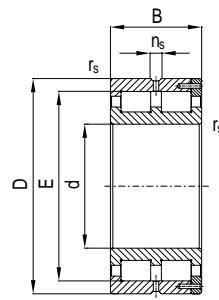

NNC

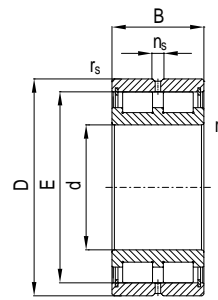

NNCL

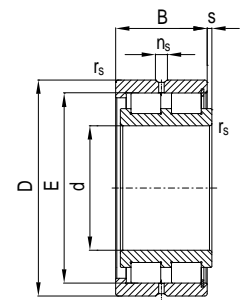

NNCF

Grenzdrehzahl	Bezugsdrehzahl	Gewicht
Limiting speed	Reference speed	Weight
n_g min ⁻¹	n_{th} min ⁻¹	kg
660	330	52
630	320	138
630	320	138
630	320	138
630	310	76
630	310	76
630	310	76
600	300	140
600	300	140
600	300	140
600	300	80
600	300	80
600	300	80
570	290	165
570	290	165
570	290	165
580	280	82
580	280	82
580	280	82
550	270	175
550	270	175
550	270	175
-	-	357
550	260	85
550	260	85
550	260	85
520	250	200
520	250	200
520	250	200
490	240	235
490	240	235
490	240	235
460	220	280
460	220	280
460	220	280
440	210	360
440	210	360
440	210	360
410	190	420
410	190	420
410	190	420

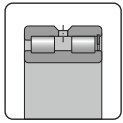

Zylinderrollenlager (vollrollig), zweireihig
Cylindrical Roller Bearings (Full Complement), Double Row

Kurzzeichen	Abmessung							Tragzahl		Ermüdungs- grenzbelastung
								stat.	dyn.	
Code	Dimension							Load rating		Fatigue stress limit
								stat.	dyn.	
	d mm	D mm	B mm	r _{s min} mm	s mm	n _s mm	E mm	C ₀ kN	C kN	C ₁₀ kN
NNC49/710V	710	950	243	6	–	23,5	888	18360	6380	1690
NNCF49/710V	710	950	243	6	10	23,5	888	18360	6380	1690
NNCL49/710V	710	950	243	6	12	23,5	888	18360	6380	1690

► Weitere Ausführungen auf Anfrage | Other versions on request

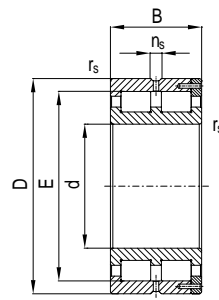

NNC

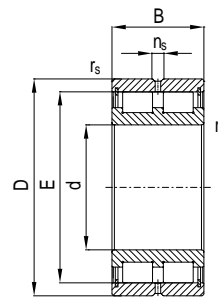

NNCL

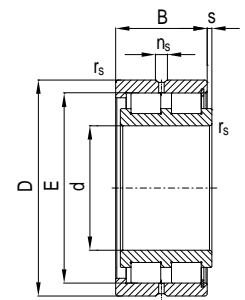

NNCF

Grenzdrehzahl	Bezugsdrehzahl	Gewicht
Limiting speed	Reference speed	Weight
n_g min ⁻¹	n_{th} min ⁻¹	kg
390	180	490
390	180	490
390	180	490

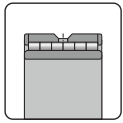

Zylinderrollenlager (vollrollig), mehrreihig
Cylindrical Roller Bearings (Full Complement), Multi Row

Kurzzeichen Code	Abmessung Dimension							Tragzahl Load rating		Ermüdungs- grenzbelastung Fatigue stress limit C ₀ kN
	d mm	D mm	B mm	r _{s min} mm	s mm	n _s mm	F _r E mm	stat.	dyn.	
								C ₀ kN	C kN	
NNU6908V	40	62	40	0,6	1,8	-	40,85	175	82	21
NNU6008V	40	68	50	1	1,8	-	43,15	227	113	31,9
NNU6909V	45	68	40	0,6	1,8	-	52,35	191	87	25,7
NNU6009V	45	75	54	1	1,3	-	53,65	302	155	39,2
NNU6910V	50	72	40	0,6	1,8	-	56,15	205	91	30,9
NNU6010V	50	80	54	1	1,3	-	59,4	338	162	47
NNU6911V	55	80	45	1	1,1	-	62,2	284	127	36,5
NNU6011V	55	90	63	1,1	1,4	-	64,85	439	210	55,5
NNU6912V	60	85	45	1	1,1	-	67	310	133	42,5
NNU6012V	60	95	63	1,1	1,4	-	71,5	485	222	64,6
NNU6913V	65	90	45	1	1,1	-	71,75	333	139	48,8
NNU6013V	65	100	63	1,1	1,4	-	76	520	229	74,2
NNU6914V	70	100	54	1	1,3	4,5	78,45	445	188	55,5
NNU6014V	70	110	71	1,1	1,4	-	81,75	635	285	84,4
NNU6915V	75	105	54	1	1,3	4,5	84,2	475	195	62,6
NNU6015V	75	115	71	1,1	1,4	-	86,8	680	300	95,1
NNU6916V	80	110	54	1	1,3	4,5	88	490	200	70
NNU6016V	80	125	80	1,1	1,5	-	95	820	360	106,3
NNU6917V	85	120	63	1,1	1,4	4,5	96	655	260	77,8
NNU6017V	85	130	80	1,1	1,5	-	97,75	865	365	118,1
NNU6918V	90	125	63	1,1	1,4	4,5	100,5	670	270	85,9
NNU6018V	90	140	90	1,5	1,8	-	105	1040	450	130,5
NNU6919V	95	130	63	1,1	1,4	4,5	105	720	270	94,4
NNU6019V	95	145	90	1,5	1,8	-	108,5	1080	450	143,3
11.09.02	100	140	40	1,1	-	-	-	415	212	36
NNU6920V	100	140	71	1,1	1,4	6,5	112,25	890	350	103,2
NNU6020V	100	150	90	1,5	1,8	-	115	1150	480	156,6
NNU6921V	105	145	71	1,1	1,4	6,5	117,25	930	345	112,3
NNU6021V	105	160	100	2	2,3	-	123	1340	540	170,5
NNU6922V	110	150	71	1,1	1,4	6,5	122,5	970	360	121,8
NNU6022V	110	170	109	2	2,4	-	126,5	1600	630	184,8
NNU6924V	120	165	80	1,1	1,5	6,5	132	1200	430	141,7
NNU6024V	120	180	109	2	2,4	-	138	1700	660	214,9
NNU6926V	130	180	90	1,5	1,8	6,5	143,5	1500	530	162,9
NNU6026V	130	200	125	2	2,4	-	152	2100	850	247
NNU6928V	140	190	90	1,5	1,8	-	156,25	1600	540	185,3
NNU6028V	140	210	125	2	2,4	-	161	2300	870	280,8
NNU6930V	150	210	109	2	2,4	-	168,25	2100	720	208,9
NNU6030V	150	225	136	2,1	2,8	-	172,5	2600	1000	316,6
NNU6932V	160	220	109	2	2,4	-	179,75	2200	750	233,7
NNU6032V	160	240	145	2,1	2,9	-	184	3000	1200	354,1

► Weitere Ausführungen auf Anfrage | Other versions on request

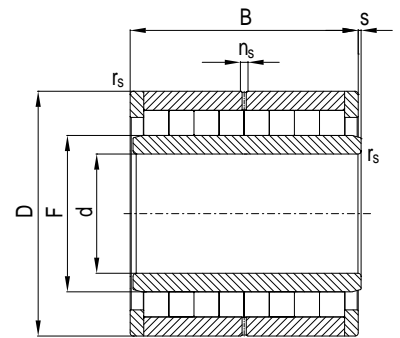

NNU

Grenzdrehzahl	Bezugsdrehzahl	Gewicht
Limiting speed	Reference speed	Weight
n_g min ⁻¹	n_{th} min ⁻¹	kg
2600	4800	0,5
2400	4500	0,9
2200	4300	0,6
2200	4300	1
2200	4300	0,6
2000	4000	1,2
1900	3800	0,8
1800	3600	1,7
1800	3600	0,9
1600	3200	2
1600	3200	0,9
1500	3000	1,9
1500	3000	1,4
1400	2800	2,8
1400	2800	1,5
1300	2600	2,8
1300	2600	1,6
1200	2400	4
1200	2400	2,3
1200	2400	4
1100	2200	2,4
1100	2200	5,4
1100	2200	2,5
1000	2000	5,5
-	-	2
1000	2000	3,5
1000	2000	5,8
950	1900	3,6
900	1800	7,4
950	1900	3,8
950	1900	9,3
850	1700	5,3
850	1700	10
800	1600	7,2
750	1500	15
750	1500	7,5
700	1400	15,6
700	1400	12
650	1300	20
650	1200	12,6
600	1100	24

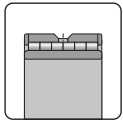

Zylinderrollenlager (vollrollig), mehrreihig
Cylindrical Roller Bearings (Full Complement), Multi Row

Kurzzeichen	Abmessung							Tragzahl		Ermüdungs- grenzbelastung
								stat.	dyn.	
Code	Dimension							Load rating		Fatigue stress limit
								stat.	dyn.	
	d mm	D mm	B mm	r _{s min} mm	s mm	n _s mm	F _r E mm	C ₀ kN	C kN	C _u kN
NNU6934V	170	230	109	2	2,4	-	187,5	2300	770	259,7
NNU6034V	170	260	160	2,1	3	-	195,25	3600	1350	393,4
NNU6936V	180	250	125	2	2,4	-	201	2900	1000	286,9
NNU6036V	180	280	180	2,1	3,5	-	210,5	4300	1650	434,4
NNU6938V	190	260	125	2	2,4	-	209,75	3000	1000	315,1
NNU6038V	190	290	180	2,1	3,5	-	223,25	4600	1700	477,1
NNU6940V	200	280	145	2,1	2,9	-	224,5	3700	1250	344,5
NNU6040V	200	310	200	2,1	4	-	232	5200	1950	521,5
NNU6944V	220	300	145	2,1	2,9	-	244,75	4000	1350	406,7
NNU6044V	220	340	218	3	4,3	-	252,5	6300	2300	615,3
NNU6948V	240	320	145	2,1	2,9	-	265,25	4300	1400	473,1
NNU6048V	240	360	218	3	4,4	-	275,5	6800	2400	715,6
NNU6952V	260	360	180	2,1	3,5	-	293,25	6000	1950	543,8
NNU6052V	260	400	250	4	4,6	-	303,5	8700	3100	822,2
NNU6956V	280	380	180	2,1	3,5	-	312,5	6400	2000	618,6
NNU6056V	280	420	250	4	4,6	-	321,5	9200	3200	935
NNU6960V	300	420	218	3	3,8	-	336,5	8300	2700	697,4
NNU6060V	300	460	290	4	5,6	-	347	11300	4000	1054
NNU6964V	320	440	218	3	3,8	-	359,5	9000	2800	780,3
NNU6064V	320	480	290	4	5,6	-	367	12500	4100	1178,9
NNU6968V	340	460	218	3	3,8	-	374,7	9300	2800	867,1
NNU6068V	340	520	325	5	6,5	-	391,5	14500	4900	1309,6
NNU6972V	360	480	218	3	3,8	-	397,6	10000	3000	957,7
NNU6072V	360	540	325	5	6,5	-	413	16000	5200	1446,2
NNU6976V	380	520	250	4	4,9	-	419,2	12000	3600	1052,1
NNU6076V	380	560	325	5	6,5	-	436	16000	5200	1588,5
NNU6980V	400	540	250	4	5	-	445,9	13000	3800	1150,3
NNU6080V	400	600	355	5	6	-	459	19000	6200	1736,3
NNU6984V	420	560	250	4	5	-	463,7	14000	3900	1252,1
NNU6084V	420	620	355	5	6	-	485	20000	6400	1889,7
NNU6988V	440	600	290	4	5,6	-	489	16000	4800	1357,7
NNU6088V	440	650	375	6	7	-	509	22000	7000	2048,6
11.69.01	700	950	405	6	-	-	-	28165	10090	2006

► Weitere Ausführungen auf Anfrage | Other versions on request

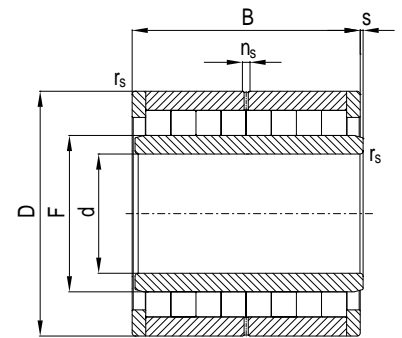

NNU

Grenzdrehzahl	Bezugsdrehzahl	Gewicht
Limiting speed	Reference speed	Weight
n_g min^{-1}	n_{th} min^{-1}	kg
600	1100	13,5
550	1000	32
550	1000	20
500	900	43
550	950	20
500	900	45
500	850	30
450	800	57
450	800	32
430	750	75
400	700	33
370	650	80
360	640	58
350	600	120
340	600	61
320	550	125
320	560	96
300	530	180
300	520	100
280	500	190
280	500	108
260	470	260
260	480	112
240	450	270
240	450	163
240	450	280
240	450	170
220	420	365
220	430	175
200	400	380
220	420	245
200	400	440
-	-	796

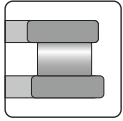

Axial-Zylinderrollenlager
Cylindrical Roller Thrust Bearings

Kurzzeichen	Abmessung							Tragzahl		Ermüdungs- grenzbelastung
								stat.	dyn.	
Code	Dimension							Load rating		Fatigue stress limit
								stat.	dyn.	
	d mm	D mm	T mm	d _i mm	D ₁ mm	h mm	r _{s min} mm	C ₀ kN	C kN	C _u kN
81108M	40	60	13	60	42	3,5	0,6	110	36	15
81208M	40	68	19	68	42	5	1	210	74	30
89308M	40	78	22	78	42	7,5	1	285	80	37
81109M	45	65	14	65	47	4	0,6	140	42	20
81209M	45	73	20	73	47	5,5	1	250	82	35
89309M	45	85	24	85	47	8,25	1	400	104	53
81110M	50	70	14	70	52	4	0,6	140	43	20
81210M	50	78	22	78	52	6,5	1	290	89	41
89310M	50	95	27	95	52	9,5	1,1	455	116	60
81111M	55	78	16	78	57	5	0,6	190	50	27
81211M	55	90	25	90	57	7	1	390	121	55
89311M	55	105	30	105	57	10,5	1,1	630	156	69
81112M	60	85	17	85	62	4,75	1	280	78	39
81212M	60	95	26	95	62	7,5	1	390	120	55
89312M	60	110	30	110	62	10,5	1,1	630	153	77
89412M	60	130	42	130	62	14	1,5	1020	280	120
81113M	65	90	18	90	67	5,25	1	280	77	39
81213M	65	100	27	100	67	8	1	410	124	58
89313M	65	115	30	115	67	10,5	1,1	630	153	79
89413M	65	140	45	140	68	15	2	1180	315	131
81114M	70	95	18	95	72	5,25	1	300	78	42
81214M	70	105	27	105	72	8	1	440	127	62
89314M	70	125	34	125	72	12	1,1	750	180	92
89414M	70	150	48	150	73	16	2	1340	360	142
81115M	75	100	19	100	77	5,75	1	310	80	44
89315M	75	135	36	135	77	12,5	1,5	865	208	106
89415M	75	160	51	160	78	17	2	1530	400	162
81116M	80	105	19	105	82	5,75	1	340	84	48
81216M	80	115	28	115	82	8,5	1	480	134	68
89316M	80	140	36	140	82	12,5	1,5	915	216	112
89416M	80	170	54	170	83	18	2,1	1700	440	180
81117M	85	110	19	110	87	5,75	1	350	85	49
81217M	85	125	31	125	88	9,5	1	610	166	86
89317M	85	150	39	150	88	13,5	1,5	1100	255	135
89417M	85	180	58	180	88	19,5	2,1	1900	490	201
81118M	90	120	22	120	92	6,5	1	450	111	63
81218M	90	135	35	135	93	10,5	1,1	670	191	94
89318M	90	155	39	155	93	13,5	1,5	1160	265	142
89418M	90	190	60	190	93	20	2,1	2120	540	224
81120M	100	135	25	135	102	7	1	610	153	86
81220M	100	150	38	150	103	11,5	1,1	820	226	115
89320M	100	170	42	170	103	14,5	1,5	1430	315	175

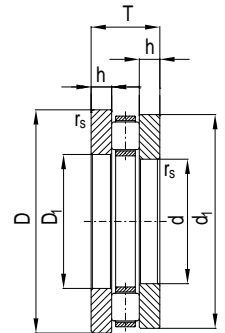

811, 812, 893, 894

Grenzdrehzahl	Bezugsdrehzahl	Gewicht
Limiting speed	Reference speed	Weight
n_g min ⁻¹	n_{th} min ⁻¹	kg
5400	2600	0,1
5300	2110	0,3
4940	-	0,5
4850	2360	0,1
4900	1930	0,3
4430	-	0,6
4470	2240	0,2
4440	1780	0,4
4010	-	0,9
4050	2000	0,2
3950	1740	0,6
3670	-	1,2
3770	1870	0,3
3700	1470	0,7
3380	-	1,3
3000	-	3,1
3520	1750	0,3
3470	1370	0,7
3140	-	1,4
2780	-	3,8
3370	1690	0,3
3240	1310	0,8
2930	-	2
2600	-	4,6
3160	1590	0,4
2750	-	2,5
2440	-	5,6
2970	1490	0,4
2860	1180	0,9
2590	-	2,6
2300	-	6,7
2870	1450	0,4
2700	1100	1,3
2440	-	3,3
2170	-	8
2640	1320	0,6
2550	1020	1,8
2320	-	3,4
2060	-	9,2
2410	1200	0,9
2300	920	2,8
2100	-	4,4

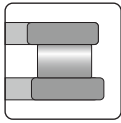

Axial-Zylinderrollenlager
Cylindrical Roller Thrust Bearings

Kurzzeichen	Abmessung							Tragzahl		Ermüdungs- grenzbelastung
								stat.	dyn.	
Code	Dimension							Load rating		Fatigue stress limit
								stat.	dyn.	
	d mm	D mm	T mm	d _i mm	D ₁ mm	h mm	r _{s min} mm	C ₀ kN	C kN	C ₀ kN
89420M	100	210	67	210	103	22,5	3	2750	680	290
81122M	110	145	25	145	112	7	1	680	163	83
81222M	110	160	38	160	113	11,5	1,1	910	240	111
89322M	110	190	48	190	113	16,5	2	1870	500	198
89422M	110	230	73	230	113	24,5	3	3350	800	302
81124M	120	155	25	155	122	7	1	730	169	89
81224M	120	170	39	170	123	12	1,1	960	245	118
89324M	120	210	54	210	123	18,5	2,1	2420	640	256
89424M	120	250	78	250	123	26	4	3900	930	351
81126M	130	170	30	170	132	9	1	840	196	103
81226M	130	190	45	190	133	13	1,5	1400	366	172
89326M	130	225	58	225	134	20	2,1	2900	610	306
89426M	130	270	85	270	134	28,5	4	4500	1060	405
81128M	140	180	31	178	142	9,5	1	910	205	111
81228M	140	200	46	197	143	13,5	1,5	1480	376	181
89328M	140	240	60	240	144	20,5	2,1	3250	670	343
89428M	140	280	85	280	144	28,5	4	4800	1100	432
81130M	150	190	31	188	152	9,5	1	980	213	120
81230M	150	215	50	212	153	14,5	1,5	2370	561	290
89330M	150	250	60	250	154	20,5	2,1	3550	710	375
89430M	150	300	90	300	154	30	4	5500	1250	495
81132M	160	200	31	198	162	9,5	1	1050	221	129
81232M	160	225	51	222	163	15	1,5	1880	465	230
89332M	160	270	67	270	164	23	3	4270	855	451
87432M	160	320	73	320	164	25,5	5	6420	1139	786
89432M	160	320	95	320	164	31,5	5	6500	1780	585
81134M	170	215	34	213	172	10	1,1	1260	272	154
81234M	170	240	55	237	173	16,5	1,5	2270	541	278
89334M	170	280	67	280	174	23	3	4500	865	475
89434M	170	340	103	340	174	34,5	5	7200	1600	648
81136M	180	225	34	222	183	10	1,1	1340	282	164
81236M	180	250	56	247	183	17	1,5	2370	553	290
89336M	180	300	73	300	184	24,5	3	5200	1040	549
89436M	180	360	109	360	184	36,5	5	8200	2210	738
81138M	190	240	37	237	193	11	1,1	1460	308	179
81238M	190	270	62	267	194	18	2	2880	692	353
89338M	190	320	78	320	195	26	4	6100	1220	644
89438M	190	380	115	380	195	38,5	5	9000	1960	810
81140M	200	250	37	247	203	11	1,1	1500	312	184
81240M	200	280	62	277	204	18	2	3020	712	370
89340M	200	340	85	340	205	28,5	4	7100	1400	750
89440M	200	400	122	400	205	41	5	10000	2160	900

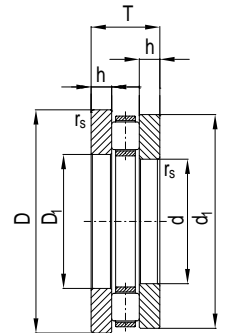

811, 812, 893, 894

Grenzdrehzahl	Bezugsdrehzahl	Gewicht
Limiting speed	Reference speed	Weight
n_g min ⁻¹	n_{th} min ⁻¹	kg
1870	–	12,6
2210	1100	1
2120	850	3
1920	–	6,6
1710	–	16,5
2090	1060	1,3
1950	790	3,3
1770	–	9,2
1580	–	20,7
1890	950	2
1800	710	4,8
1640	–	10,8
1470	–	26,3
1780	890	2,1
1690	690	5,2
1530	–	12,6
1370	–	27,6
1670	840	2,2
1580	630	6,6
1440	–	13,2
1290	–	33,5
1610	820	2,4
1490	610	7,1
1350	–	17,5
1100	–	31,3
1210	–	42
1520	770	3,1
1400	560	9,3
1280	–	18,4
1150	–	49,4
1430	730	3,2
1340	540	9,3
1210	–	23,2
1090	–	60,2
1360	690	4,7
1250	500	12,8
1150	–	28,4
1030	–	68,8
1210	600	5
1210	490	13,6
1100	–	35,4
990	–	80,9

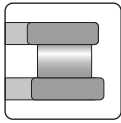

Axial-Zylinderrollenlager
Cylindrical Roller Thrust Bearings

Kurzzeichen	Abmessung							Tragzahl		Ermüdungs- grenzbelastung
								stat.	dyn.	
Code	Dimension							Load rating		Fatigue stress limit
								stat.	dyn.	
	d mm	D mm	T mm	d _i mm	D _i mm	h mm	r _{s min} mm	C ₀ kN	C kN	C ₀ kN
81144M	220	270	37	267	223	11	1,1	1680	334	206
81244M	220	300	63	297	224	18,5	2	3290	747	403
89444M	220	420	122	420	225	41	6	11500	2900	870
60.23.01	240	297	45	297	240	13,5	1,5	2500	600	249
81148M	240	300	45	297	243	13,5	1,5	2430	478	298
81248M	240	340	78	335	244	23	2,1	4860	1099	595
89348M	240	380	85	380	245	28,5	4	8000	1500	845
89448M	240	440	112	440	245	41	6	12000	2400	908
81152M	260	320	45	317	263	13,5	1,5	2560	489	270
81252M	260	360	79	355	264	23,5	2,1	5280	1148	558
89452M	260	480	132	480	265	43,5	6	15000	3000	1134
81156M	280	350	53	347	283	15,5	1,5	3550	689	375
81256M	280	380	80	375	284	24	2,1	5490	1171	580
89456M	280	520	145	520	285	48,5	6	17600	4200	1331
81160M	300	380	62	376	304	18,5	2	4380	849	463
81260M	300	420	95	415	304	28,5	3	7140	1535	754
89460M	300	540	145	540	305	47,5	6	18600	3650	1407
25.28.01	304	300	120	380	280	19	2,1	4000	860	385
81164M	320	400	63	396	324	19	2	4630	878	489
81264M	320	440	95	435	325	28,5	3	6850	1478	724
89464M	320	580	155	580	325	51,5	7,5	20000	3900	1513
25.29.01	330	417	146	420	300	24	3	5200	1060	469
81168M	340	420	64	416	344	19,5	2	4890	903	517
81268M	340	460	96	455	345	29	3	8040	1641	849
89468M	340	620	170	620	345	57	7,5	23700	4550	1792
81172M	360	440	65	436	364	20	2	5020	908	530
81272M	360	500	110	495	365	32,5	4	10400	2156	1099
89472M	360	640	170	640	365	57	7,5	25000	4650	1891
81176M	380	460	65	456	384	20	2	5280	935	558
81276M	380	520	112	515	385	33,5	4	10810	2210	1142
89476M	380	670	175	670	385	57,5	7,5	27000	5100	2042
81180M	400	480	65	476	404	20	2	5530	959	584
81280M	400	540	112	535	405	33,5	4	10400	2125	1099
89480M	400	710	185	710	405	60,5	7,5	30500	5700	2307
81184M	420	500	65	495	424	20	2	5790	983	612
81284M	420	580	130	575	425	39	5	14010	2835	1480
89484M	420	730	185	730	425	60,5	7,5	32500	6000	2458
81188M	440	540	80	535	444	24	2,1	8030	1426	848
81288M	440	600	130	595	445	39	5	13450	2740	1421
89488M	440	780	206	780	445	69	9,5	36500	6550	2760
81192M	460	560	80	555	464	24	2,1	8030	1413	848
81292M	460	620	130	615	465	39	5	14010	2802	1480

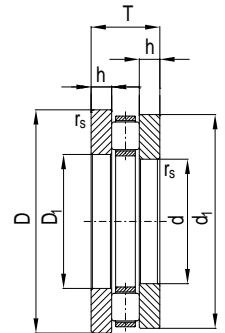

811, 812, 893, 894

Grenzdrehzahl	Bezugsdrehzahl	Gewicht
Limiting speed	Reference speed	Weight
n_g min ⁻¹	n_{th} min ⁻¹	kg
1210	630	5,2
1110	460	14,7
900	-	84,4
1090	-	8,05
1090	550	8,1
990	400	25,6
930	-	40,6
830	-	91,8
1030	520	9,1
930	370	28
770	-	119
940	480	12,6
870	350	30,1
720	-	142
870	440	19,4
800	320	45,7
680	-	161
800	-	39,8
820	410	20,7
780	300	48,5
640	-	201
800	-	58
790	390	22,4
740	290	52,8
600	-	254
750	380	22,9
700	260	75,6
570	-	264
730	360	22,4
660	260	79,7
550	-	295
690	350	26,6
630	240	83,2
520	-	352
670	330	26,4
600	220	110
500	-	365
610	310	43,7
580	220	123
480	-	475
600	300	45,5
550	210	128

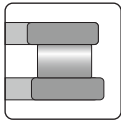

Axial-Zylinderrollenlager
Cylindrical Roller Thrust Bearings

Kurzzeichen	Abmessung							Tragzahl		Ermüdungs- grenzbelastung
								stat.	dyn.	
	Code	Dimension							Load rating	
stat.									dyn.	
	d mm	D mm	T mm	d _i mm	D ₁ mm	h mm	r _{s min} mm	C ₀ kN	C kN	C ₀ kN
89492M	460	800	206	800	465	69	9,5	38000	6800	2874
81196M	480	580	80	575	484	24	2,1	8240	1429	870
81296M	480	650	135	645	485	39,5	5	15490	3120	1636
89496M	480	850	224	850	485	74,5	9,5	42500	7650	3214
811/500M	500	600	80	595	505	24	2,1	9080	1522	890
812/500M	500	670	135	665	505	39,5	5	15490	3096	1636
894/500M	500	870	224	870	505	74,5	9,5	45000	8000	3403
811/530M	530	640	85	635	535	25,5	3	10160	1694	914
24.53.01	530	710	140	702	535	40	5	21000	4800	1675
812/530M	530	710	140	705	535	40	5	18610	3649	1675
24.55.01	560	665	85	665	560	27,5	3	9830	1530	940
811/560M	560	670	85	665	565	25,5	3	10640	1734	958
812/560M	560	750	150	745	565	45	5	19360	3712	1742
24.59.01	600	710	85	706	604	25,5	3	11600	1800	1000
811/600M	600	710	85	705	605	25,5	3	11110	1766	1000
812/600M	600	800	160	795	605	48	5	21960	4173	1976
811/630M	630	750	95	745	635	28,5	3	13990	2212	1259
812/630M	630	850	175	845	635	53,5	6	24890	4688	2240
811/670M	670	800	105	795	675	31,5	4	14890	2355	1340
812/670M	670	900	180	895	675	52,5	6	30030	5633	2703
891/710M	710	850	85	845	715	26,5	4	18590	2440	1406
811/710M	710	850	112	845	715	33,5	4	17050	2752	1460
812/710M	710	950	190	945	715	57,5	6	31190	5723	2807
893/710M	710	1060	222	1060	715	76	9,5	55000	8500	4159
24.71.01	750	875	85	870	750	31,5	4	17775	1895	1422
811/750M	750	900	120	895	755	36	4	20910	3287	1535
812/750M	750	1000	195	995	755	57,5	6	35640	6489	3208
891/800M	800	950	90	945	805	29	4	21060	2612	1593
811/800M	800	950	120	945	805	36	4	20910	3244	1581
812/800M	800	1060	205	1055	805	60	7,5	39880	7152	3016
811/850M	850	1000	120	995	855	36	4	22810	3421	1725
812/850M	850	1120	212	1115	855	61	7,5	44620	7903	3374
24.84.01	850	975	90	973	860	27	5	15710	2200	1200
811/900M	900	1060	130	1055	905	39	5	25820	3810	1953
812/900M	900	1180	220	1175	905	65	7,5	48710	8441	3684
811/950M	950	1120	135	1115	955	40,5	5	28540	4160	2158
812/950M	950	1250	236	1245	955	68	7,5	55910	9567	4228
811/1000M	1000	1180	140	1175	1005	42	5	31060	4500	2349
812/1000M	1000	1320	250	1315	1005	75	9,5	59200	10054	4477
811/1060M	1060	1250	150	1245	1065	45	5	34650	4970	2620

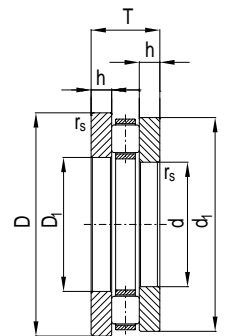

811, 812, 893, 894

Grenzdrehzahl	Bezugsdrehzahl	Gewicht
Limiting speed	Reference speed	Weight
n_g min ⁻¹	n_{th} min ⁻¹	kg
460	–	490
570	280	47,3
530	200	147
440	–	611
560	280	48,9
510	190	153
420	–	630
530	260	61,6
490	180	178
490	180	178
500	260	63
500	260	64,3
460	170	214
480	240	62
480	240	68,5
430	160	256
450	220	81,2
410	150	302
410	210	104
390	140	342
740	–	97,5
390	200	127
370	130	402
340	–	767
720	–	97,8
360	180	155
350	130	452
660	–	125
350	180	164
330	120	525
330	170	174
310	110	596
330	170	120
310	160	213
300	110	680
290	150	249
280	95	826
280	140	289
270	90	990
260	130	347

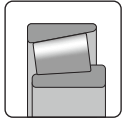

Kegelrollenlager
Tapered Roller Bearings

Kurzzeichen		Abmessung								Faktor		
national	international	Dimension								Factor		
Code		d	D	T	B	C	r _{s min}	r _{1s min}	a	e	Y	Y ₀
national	international	mm	mm	mm	mm	mm	mm	mm	mm	mm		mm
32012X	4CC	60	95	23	23	17,5	1,5	1,5	21	0,43	1,4	0,77
32014X	4CC	70	110	25	25	19	1,5	1,5	24	0,43	1,4	0,76
30314	-	70	150	38	35	30	3	2,5	33	0,35	1,7	0,95
16.07.02	-	75	130	41	41	31	2	1,5	32,2	0,43	1,4	0,77
32017X	4CC	85	130	29	29	22	1,5	1,5	28	0,44	1,4	0,75
32020X	4CC	100	150	32	32	24	2	1,5	33	0,46	1,3	0,72
32021X	4DC	105	160	35	35	26	2,5	2	35	0,44	1,4	0,74
30322A	-	110	240	54,5	50	42	4	3	45	0,35	1,7	0,95
32322A	-	110	240	84,5	80	65	4	3	58	0,35	1,7	0,95
32024X	4DC	120	180	38	38	29	2,5	2	40	0,46	1,3	0,72
32224	-	120	215	61,5	58	50	3	2,5	56	0,48	1,2	0,68
30324A	-	120	260	59,5	55	46	4	3	48	0,35	1,7	0,95
32026X	4EC	130	200	45	45	34	2,5	2	44	0,43	1,4	0,76
16.12.01	-	130	230	67,75	64	54	4	3	56	0,44	1,4	0,75
16.13.01	-	139,7	228,6	58,73	57,15	44,45	3,3	1,5	48,4	0,42	1,4	0,78
32028X	40C	140	210	45	34	45	2,5	2	46	0,46	1,3	0,7
32328A	-	140	300	107,8	102	85	5	4	74	0,35	1,7	0,95
32930	2DC	150	210	38	38	30	2,5	2	36	0,33	1,8	1,01
32030X	4EC	150	225	48	48	36	3	2,5	49	0,46	1,3	0,72
30330A	-	150	320	72	65	55	5	4	60	0,35	1,7	0,95
32330A	-	150	320	114	108	90	5	4	79	0,35	1,7	0,95
32032X	4EC	160	240	51	51	38	3	2,5	53	0,46	1,3	0,72
32232A	-	160	290	84	80	67	4	3	69	0,43	1,4	0,76
30332A	-	160	340	75	68	58	5	4	63	0,35	1,7	0,95
32034X	4EC	170	260	57	57	43	3	2,5	57	0,44	1,4	0,74
30234A	-	170	310	57	52	43	5	4	60	0,43	1,4	0,76
32234A	-	170	310	91	86	71	5	4	74	0,43	1,4	0,76
30334	-	170	360	80	72	62	5	4	72	0,4	1,5	0,82
30334A	-	170	360	80	72	62	5	4	67	0,35	1,7	0,95
32238A	-	190	340	97	92	75	5	4	81	0,43	1,4	0,76
32940	3EC	200	280	51	51	39	3	2,5	54	0,39	1,5	0,84
32040X	4FD	200	310	70	70	53	3	2,5	67	0,43	1,4	0,77
32240A	-	200	360	104	98	82	5	4	77	0,41	1,5	0,81
32944	3EC	220	300	51	51	39	3	2,5	59	0,43	1,4	0,78
32044	-	220	340	76	72	62	4	4	68	0,35	1,7	0,95
32044X	4FD	220	340	76	76	57	4	3	73	0,43	1,4	0,77
32244A	-	220	400	114	108	90	5	4	94	0,43	1,4	0,76
32948	4EC	240	320	51	51	39	3	2,5	65	0,46	1,3	0,72
32048X	4FD	240	360	76	76	57	4	3	152	0,46	1,3	0,72
32248A	-	240	440	127	120	100	5	4	95	0,43	1,4	0,76
16.24.01	-	254	533	133,35	120,65	77,788	6,4	6,4	157	0,94	1,4	0,78
32952	3EC	260	360	63,5	63,5	48	3	2,5	69	0,41	1,5	0,81

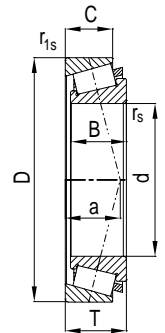

303, 320, 322, 323, 329

	Tragzahl		Ermüdungs- grenzbelastung	Grenzdrehzahl	Bezugsdrehzahl	Gewicht
	stat.	dyn.				
	Load rating		Fatigue stress limit	Limiting speed	Reference speed	Weight
	stat.	dyn.				
	C_0 kN	C kN	C_u kN	n_g min ⁻¹	n_{th} min ⁻¹	kg
	120	80	17	6700	4450	0,6
	160	110	23	5700	3810	0,8
	250	220	35	4800	3240	3,1
	250	176	36	4700	–	2,25
	220	140	31	4700	3300	1,4
	280	170	39	4000	2900	1,9
	320	200	39	3800	2820	2,4
	590	480	72	2800	2410	11,3
	990	720	121	2800	2080	18,3
	410	250	50	3300	2480	3,3
	720	450	88	3000	2130	9,2
	700	560	86	2600	2160	14,5
	540	320	66	3000	2350	5
	780	520	93	2800	–	11,1
	680	405	81	2800	–	9,1
	600	340	44	2800	2200	5,39
	1640	1140	201	2400	1500	36,6
	510	290	62	2700	1720	3,4
	640	370	78	2600	2040	6,4
	1000	790	123	2200	1660	25,8
	1870	1280	229	2200	1360	44
	760	430	93	2500	1830	7,9
	1360	860	167	2200	1420	23,8
	1110	870	136	2100	1530	30,3
	900	510	110	2300	1670	10,6
	840	600	103	2100	1570	17,2
	1550	970	190	2100	1310	29,3
	1430	950	175	1900	1170	36,6
	1320	1010	162	2000	1370	36,6
	1800	1130	221	1800	1150	36,7
	910	490	111	2100	1250	9,5
	1320	740	162	2000	1320	19,1
	2010	1290	246	1700	1080	44,1
	1000	500	123	1900	1110	10,5
	1470	840	180	1800	1070	24,7
	1570	870	192	1800	1160	24,7
	2470	1510	303	1600	930	60,8
	1090	530	134	1700	1000	11,2
	1700	930	208	1600	940	26,2
	3030	1820	371	1400	810	82,7
	2600	1805	246	1200	–	120
	1470	740	155	1600	890	19,5

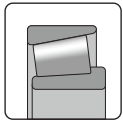

Kegelrollenlager
Tapered Roller Bearings

Kurzzeichen		Abmessung								Faktor		
national	international											
Code		Dimension								Factor		
national	international	d mm	D mm	T mm	B mm	C mm	r _{s min} mm	r _{1s min} mm	a mm	e	Y	Y ₀ mm
32052X	4FC	260	400	87	87	65	5	4	85	0,43	1,4	0,76
32956	4EC	280	380	63,5	63,5	48	3	2,5	75	0,43	1,4	0,76
32056X	4FC	280	420	87	87	65	5	4	90	0,46	1,3	0,72
32960	3FD	300	420	76	76	57	4	3	80	0,39	1,5	0,84
32060X	4GD	300	460	100	100	74	5	4	98	0,43	1,4	0,76
16.38.01	-	390	470	45	43,41	34,92	6,4	3,3	75	0,39	1,5	0,85
16.55.01	-	559	736,6	104,77	104,77	80,96	6,4	6,4	117,86	0,35	1,7	0,95
16.83.01	-	838,2	1041,4	99,66	88,9	66,67	6,4	6,4	172,1	0,44	1,4	0,75

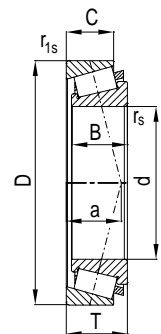

303, 320, 322, 323, 329

Tragzahl		Ermüdungs- grenzbelastung	Grenzdrehzahl	Bezugsdrehzahl	Gewicht
stat.	dyn.				
Load rating		Fatigue stress limit	Limiting speed	Reference speed	Weight
stat.	dyn.				
C_0 kN	C kN	C_u kN	n_g min^{-1}	n_{th} min^{-1}	kg
2080	1130	220	1500	930	38,7
1610	770	170	1400	810	20,2
2250	1180	237	1400	850	41,1
2100	1010	222	1300	720	32,2
2760	1470	292	1300	690	58,3
1140	462	105	1350	–	14,7
5730	2340	467	850	–	120
5900	2400	430	600	–	58,3

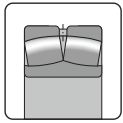

Pendelrollenlager
Spherical Roller Bearings, Double Row

Kurzzeichen	Abmessung					Faktor				Tragzahl	
										stat.	dyn.
Code	Dimension					Factor				Load rating	
										stat.	dyn.
	d mm	D mm	B mm	r _{s min} mm	n _s mm	e	Y ₁	Y ₂	Y ₀	C ₀ kN	C kN
22216EA.S.M	80	140	33	2	6,5	0,22	3,1	4,6	3	270	210
22316EA.S.M	80	170	58	2,1	9,5	0,35	2	2,9	1,9	510	410
22317EA.S.M	85	180	60	3	9,5	0,33	2	3	2	570	465
22218EA.S.M	90	160	40	2	6,5	0,23	2,9	4,3	2,8	361	274
23218EA.S.M	90	160	52,4	2	6,5	0,31	2,2	3,2	2,1	508	374
22318EA.S.M	90	190	64	3	12,2	0,34	2	2,9	1,9	612	491
19.08.02	90	191	64	3	–	0,36	1,9	2,8	1,8	543	448
23120EA.S.M	100	165	52	2	6,5	0,28	2,4	3,5	2,3	570	380
30.10.01	100	170	65	2	–	0,38	1,8	2,6	1,7	601	381
22220EA.S.M	100	180	46	2,1	9,5	0,24	2,8	4,2	2,8	465	360
23220EA.S.M	100	180	60	2,1	9,5	0,35	2	2,9	1,9	670	480
22320EA.S.M	100	215	73	3	12,2	0,33	2	3	2	853	656
23022EA.S.M	110	170	45	2	6,5	0,24	2,8	4,2	2,7	520	337
24022EA.S.M	110	170	60	2	6,5	0,35	1,9	2,9	1,8	667	439
23122EA.S.M	110	180	56	2	9,5	0,32	2,1	3,2	2,1	671	442
24122EA.S.M	110	180	69	2	6,5	0,36	1,9	2,8	1,9	859	512
22222EA.S.M	110	200	53	2,1	9,5	0,25	2,7	4	2,6	640	489
23222EA.S.M	110	200	70	2,1	9,5	0,36	1,9	2,8	1,8	880	610
22322EA.S.M	110	240	80	3	15	0,33	2,1	3,1	2	1080	840
23024EA.S.M	120	180	46	2	6,5	0,23	3	4,4	2,9	575	363
24024EA.S.M	120	180	60	2	6,5	0,29	2,3	3,5	2,3	825	475
23124EA.S.M	120	200	62	2	9,5	0,32	2,1	3,2	2,1	815	540
24124EA.S.M	120	200	80	2	6,5	0,4	1,7	2,5	1,6	1125	660
22224EA.S.M	120	215	58	2,1	12,2	0,25	2,7	4	2,6	795	536
23224EA.S.M	120	215	76	2,1	9,5	0,36	1,9	2,8	1,8	1011	692
22324EA.S.M	120	260	86	3	15	0,34	2	3	2	1120	868
23026EA.S.M	130	200	52	2	9,5	0,24	2,8	4,2	2,8	718	453
30.13.01	130	200	52	2	–	0,24	3	4,4	2,9	718	453
24026EA.S.M	130	200	69	2	6,5	0,31	2,2	3,2	2,1	1030	585
23126EA.S.M	130	210	64	2	9,5	0,3	2,3	3,4	2,2	900	585
24126EA.S.M	130	210	80	2	6,5	0,37	1,8	2,7	1,8	1175	690
19.12.01	130	220	73	2	–	0,31	2,2	3,2	2,1	930	540
22226EA.S.M	130	230	64	3	12,2	0,26	2,6	3,9	2,6	910	610
23226EA.S.M	130	230	80	3	9,5	0,35	1,9	2,9	1,9	1150	770
22326EA.S.M	130	280	93	4	17,7	0,36	2	3	2	1350	1050
23028EA.S.M	140	210	53	2	9,5	0,25	2,7	4	2,6	800	490
24028EA.S.M	140	210	69	2	6,5	0,32	2,1	3,1	2,1	1080	595
23128EA.S.M	140	225	68	2,1	9,5	0,3	2,3	3,4	2,2	1020	655
24128EA.S.M	140	225	85	2,1	6,5	0,35	2	2,9	1,9	1350	780
22228EA.S.M	140	250	68	3	12,2	0,28	2,4	3,5	2,3	1060	750
23228EA.S.M	140	250	88	3	12,2	0,36	1,9	2,8	1,8	1386	924
22328EA.S.M	140	300	102	4	17,7	0,35	2	2,9	1,9	1600	1180

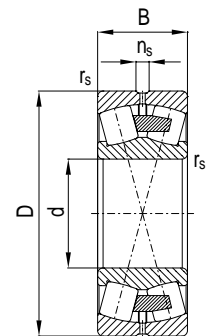

222, 223, 231, 232, 240, 241

Ermüdungs-grenzbelastung	Grenzdrehzahl	Bezugsdrehzahl	Gewicht
Fatigue stress limit	Limiting speed	Reference speed	Weight
C_u kN	n_g min ⁻¹	n_{th} min ⁻¹	kg
37	2900	3500	2
71	3800	3500	6,2
72	3600	3300	5
51	2500	3300	3,2
67	4100	2700	4,3
86	3300	3000	8,5
63	3300	3000	8,5
77	4100	2800	4,2
84	3900	-	5,7
66	2200	3000	5,2
92	3500	2400	6,6
120	2900	2600	14
62	3900	2900	4
82	3000	2400	5,1
82	3800	2600	5,5
105	2400	1800	6,9
73	2000	2800	7
104	3100	2100	9,5
129	2500	2200	20,5
69	3900	2800	4,4
95	2700	2200	5,2
95	3200	2300	7,7
138	2100	1600	10,1
97	1900	2600	8,4
122	2800	1900	11,8
137	2500	2100	22,9
86	3300	2500	6,4
86	3300	2500	6,4
126	2400	2000	7,8
107	2900	2100	8,4
144	2000	1500	10,6
114	1800	-	11,7
106	1700	2400	11
141	2500	1700	13,9
163	2200	1900	27,1
96	3200	2300	6,3
132	2400	1800	8,6
123	2700	1900	10,2
164	1900	1300	12,8
124	1600	2200	14,1
167	2300	1600	18,3
198	2100	1700	32,8

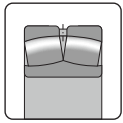

Pendelrollenlager
Spherical Roller Bearings, Double Row

Kurzzeichen	Abmessung					Faktor				Tragzahl	
										stat.	dyn.
Code	Dimension					Factor				Load rating	
										stat.	dyn.
	d mm	D mm	B mm	r _{s min} mm	n _s mm	e	Y ₁	Y ₂	Y ₀	C ₀ kN	C kN
23030EA.S.M	150	225	56	2,1	9,5	0,22	3	4,5	2,9	860	530
24030EA.S.M	150	225	75	2,1	6,5	0,33	2	3	2	1270	695
23130EA.S.M	150	250	80	2,1	12,2	0,32	2,1	3,2	2,1	1340	850
24130EA.S.M	150	250	100	2,1	9,5	0,37	1,8	2,7	1,8	1550	910
22230EA.S.M	150	270	73	3	15	0,28	2,4	3,5	2,3	1220	865
23230EA.S.M	150	270	96	3	12,2	0,37	1,8	2,7	1,8	1650	1086
22330EA.S.M	150	320	108	4	17,7	0,34	2	3	2	1850	1380
23032EA.S.M	160	240	60	2,1	12,2	0,25	2,7	4	2,6	1020	620
24032EA.S.M	160	240	80	2,1	6,5	0,33	2	3	2	1460	800
23132EA.S.M	160	270	86	2,1	15	0,32	2,1	3,2	2,1	1560	1000
24132EA.S.M	160	270	109	2,1	9,5	0,37	1,8	2,7	1,8	1800	1050
22232EA.S.M	160	290	80	3	15	0,26	2,6	3,8	2,5	1430	1000
23232EA.S.M	160	290	104	3	17,7	0,37	1,8	2,7	1,8	1960	1250
22332EA.S.M	160	340	114	4	17,7	0,37	1,8	2,7	1,8	1900	1420
23034EA.S.M	170	260	67	2,1	12,2	0,25	2,7	4	2,6	1250	750
24034EA.S.M	170	260	90	2,1	6,5	0,34	2	3	2	1760	965
23134EA.S.M	170	280	88	2,1	15	0,31	2,2	3,2	2,1	1650	1020
24134EA.S.M	170	280	109	2,1	9,5	0,39	1,7	2,6	1,7	1820	1050
22234EA.S.M	170	310	86	4	17,7	0,29	2,3	3,5	2,3	1600	1140
23234EA.S.M	170	310	110	4	17,7	0,37	1,8	2,7	1,8	2200	1400
22334EA.S.M	170	360	120	4	17,7	0,37	1,8	2,7	1,8	2120	1590
23036EA.S.M	180	280	74	2,1	15	0,23	2,9	4,3	2,8	1450	880
24036EA.S.M	180	280	100	2,1	9,5	0,36	2,1	3,1	2	1830	990
23136EA.S.M	180	300	96	3	15	0,31	2,2	3,2	2,1	1960	1220
24136EA.S.M	180	300	118	3	9,5	0,36	1,9	2,8	1,8	2200	1240
22236EA.S.M	180	320	86	4	17,7	0,28	2,4	3,5	2,3	1730	1180
23236EA.S.M	180	320	112	4	15	0,33	2	3	2	2300	1420
22336EA.S.M	180	380	126	4	15	0,33	2	3	2	2600	1900
23938EA.S.M	190	260	52	2	9,5	0,18	3,7	5,5	3,6	1030	610
23038EA.S.M	190	290	75	2,1	15	0,25	2,7	4	2,6	1540	920
24038EA.S.M	190	290	100	2,1	9,5	0,34	2	3	2	2200	1180
23138EA.S.M	190	320	104	3	15	0,33	2,1	3,1	2	2280	1400
24138EA.S.M	190	320	128	3	12,2	0,37	1,8	2,7	1,8	2500	1400
22238EA.S.M	190	340	92	4	17,7	0,28	2,4	3,5	2,3	1820	1200
23238EA.S.M	190	340	120	4	17,7	0,36	1,9	2,8	1,8	2600	1550
22338EA.S.M	190	400	132	5	23,5	0,36	1,9	2,8	2,2	2500	1850
23940EA.S.M	200	280	60	2,1	12,2	0,2	3,3	5,1	3,3	1160	700
23040EA.S.M	200	310	82	2,1	15	0,24	2,8	4,2	2,8	1790	1070
24040EA.S.M	200	310	109	2,1	9,5	0,32	2,1	3,2	2,1	2280	1210
23140EA.S.M	200	340	112	3	17,7	0,33	2	3	2	2300	1330
24140EA.S.M	200	340	140	3	12,2	0,38	1,7	2,6	1,7	3000	1700
22240EA.S.M	200	360	98	4	17,7	0,28	2,4	3,5	2,3	2200	1460

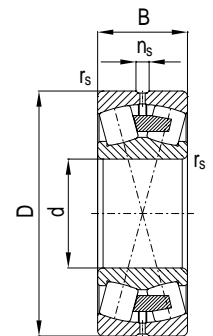

222, 223, 231, 232, 240, 241

Ermüdungs-grenzbelastung	Grenzdrehzahl	Bezugsdrehzahl	Gewicht
Fatigue stress limit	Limiting speed	Reference speed	Weight
C_u kN	n_g min^{-1}	n_{th} min^{-1}	kg
107	3100	2100	7,6
153	2200	1700	10,9
158	2500	1800	15,7
187	1700	1200	19,6
147	1500	2000	17,7
202	2100	1400	23,6
228	1900	1500	47,2
123	2700	2000	9,2
178	2000	1500	13,1
177	2300	1600	20
215	1600	1100	25,2
174	1400	1900	22,6
233	2100	1300	29,8
233	1800	1400	51,1
147	2500	1800	12,6
190	1900	1400	17,8
198	2300	1500	21,4
223	1500	1000	26,5
186	1300	1700	27,4
257	1900	1200	36,2
260	1700	1300	59,7
176	2400	1700	15,8
219	1800	1300	22,9
219	2100	1400	27,1
262	1400	930	33,3
198	1200	1600	28,7
284	1900	1200	38,5
283	1400	1200	70
126	1600	1500	8,5
186	2200	1600	17,5
239	1700	1200	24,5
241	1900	1300	33,9
311	1300	860	41,3
223	1100	1600	37,2
319	1800	1100	48
306	1500	1200	81,2
142	1600	1500	12
218	2200	1500	21,5
274	1600	1200	31,3
264	1900	1200	42,7
364	1300	790	52,6
245	1100	1400	44,4

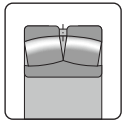

Pendelrollenlager
Spherical Roller Bearings, Double Row

Kurzzeichen	Abmessung					Faktor				Tragzahl	
										stat.	dyn.
Code	Dimension					Factor				Load rating	
										stat.	dyn.
	d mm	D mm	B mm	r _{s min} mm	n _s mm	e	Y ₁	Y ₂	Y ₀	C ₀ kN	C kN
23240EA.S.M	200	360	128	4	17,7	0,37	1,8	2,7	1,8	2700	1650
22340EA.S.M	200	420	138	5	23,5	0,36	1,9	2,8	2,2	2800	2100
23944EA.S.M	220	300	60	2,1	12,2	0,18	3,8	5,6	3,7	1280	680
23044EA.S.M	220	340	90	3	15	0,24	2,8	4,2	2,8	2120	1240
24044EA.S.M	220	340	118	3	12,2	0,34	2,2	3,2	2,1	2700	1400
23144EA.S.M	220	370	120	4	17,7	0,33	2,1	3,1	2	2900	1620
24144EA.S.M	220	370	150	4	12,2	0,42	1,6	2,4	1,6	3400	1850
22244EA.S.M	220	400	108	4	17,7	0,26	2,6	3,9	2,5	2300	1610
23244EA.S.M	220	400	144	4	17,7	0,37	1,8	2,7	1,8	3300	1950
22344EA.S.M	220	460	145	5	23,5	0,35	2	2,9	1,9	3300	2300
23948EA.S.M	240	320	60	2,1	12,2	0,17	4	5,9	4	1500	800
23048EA.S.M	240	360	92	3	15	0,25	2,7	4	2,6	2250	1200
24048EA.S.M	240	360	118	3	12,2	0,29	2,3	3,5	2,3	2980	1520
23148EA.S.M	240	400	128	4	17,7	0,32	2,1	3,2	2,1	3300	1900
24148EA.S.M	240	400	160	4	12,2	0,41	1,7	2,5	1,6	3900	2150
22248EA.S.M	240	440	120	4	23,5	0,28	2,4	3,5	2,3	3100	2000
23248EA.S.M	240	440	160	4	23,5	0,37	1,8	2,7	1,8	4200	2450
22348EA.S.M	240	500	155	5	23,5	0,35	2,2	3,2	2,1	3900	2600
23952EA.S.M	260	360	75	2,1	15	0,18	3,8	5,6	3,7	2010	1030
23052EA.S.M	260	400	104	4	17,7	0,23	2,9	4,3	2,8	2840	1630
24052EA.S.M	260	400	140	4	12,2	0,35	1,9	2,9	1,8	3800	1900
23152EA.S.M	260	440	144	4	17,7	0,31	2,2	3,3	2,2	3875	2300
24152EA.S.M	260	440	180	4	12,2	0,42	1,6	2,4	1,6	5200	2750
22252EA.S.M	260	480	130	5	23,5	0,28	2,4	3,5	2,3	3500	2250
23252EA.S.M	260	480	174	5	23,5	0,37	1,8	2,7	1,8	5000	2900
22352EA.S.M	260	540	165	6	23,5	0,33	2	3	2	4500	3000
23956EA.S.M	280	380	75	2,1	15	0,18	3,8	5,6	3,7	2150	1080
23056EA.S.M	280	420	106	4	17,7	0,25	2,7	4	2,6	3000	1550
24056EA.S.M	280	420	140	4	12,2	0,33	2	3	2	4114	2030
23156EA.S.M	280	460	146	5	17,7	0,32	2,1	3,2	2,1	4400	2400
24156EA.S.M	280	460	180	5	17,7	0,4	1,9	2,8	1,8	5200	2700
22256EA.S.M	280	500	130	5	23,5	0,27	2,5	3,7	2,4	3700	2400
23256EA.S.M	280	500	176	5	23,5	0,36	1,9	2,8	1,8	5300	3000
22356EA.S.M	280	580	175	6	23,5	0,33	2	3	2	5400	3500
23960EA.S.M	300	420	90	3	17,7	0,2	3,4	5,1	3,3	2850	1450
23060EA.S.M	300	460	118	4	17,7	0,23	3	4,4	2,9	3464	1982
24060EA.S.M	300	460	160	4	12,2	0,34	2	3	2	5200	2500
23160EA.S.M	300	500	160	5	17,7	0,32	2,1	3,2	2,1	4900	2600
24160EA.S.M	300	500	200	5	12,2	0,41	1,7	2,5	1,6	6500	3560
22260EA.S.M	300	540	140	5	23,5	0,28	2,4	3,6	2,4	4400	2700
23260EA.S.M	300	540	192	5	23,5	0,37	1,8	2,7	1,8	6200	3400
23964EA.S.M	320	440	90	3	17,7	0,19	3,5	5,2	3,4	2900	1500

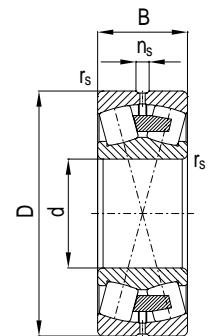

222, 223, 231, 232, 240, 241

Ermüdungs-grenzbelastung	Grenzdrehzahl	Bezugsdrehzahl	Gewicht
Fatigue stress limit	Limiting speed	Reference speed	Weight
C_u kN	n_g min^{-1}	n_{th} min^{-1}	kg
331	1600	1000	57,6
343	1400	1100	91,8
165	1500	1400	13,2
259	1900	1300	31
325	1500	1000	40,8
313	1700	1100	54,4
417	1100	690	65,3
270	970	1200	60,5
404	1500	900	81,5
404	1300	950	119
184	1500	1300	14,2
276	1700	1200	33,9
364	1300	950	44
366	1500	970	66,4
478	1100	600	80,7
320	880	1100	83,2
485	1300	810	109
439	1100	850	153
212	1400	1200	24,9
299	1600	1100	49
401	1200	880	66,1
410	1400	880	92,9
511	990	530	114
370	810	920	108
528	1200	730	142
475	1100	770	185
232	1400	1100	26,3
317	1500	980	52,5
423	1200	830	70,4
465	1300	800	100
530	930	480	119
391	750	790	113
560	1100	670	152
570	970	700	232
272	1300	1000	40,3
366	1400	900	71,5
549	1100	770	100
518	1200	730	130
665	890	430	159
465	690	680	145
655	1000	620	195
300	1300	970	42,4

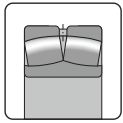

Pendelrollenlager
Spherical Roller Bearings, Double Row

Kurzzeichen	Abmessung					Faktor				Tragzahl	
										stat.	dyn.
Code	Dimension					Factor				Load rating	
										stat.	dyn.
	d mm	D mm	B mm	r _{s min} mm	n _s mm	e	Y ₁	Y ₂	Y ₀	C ₀ kN	C kN
23064EA.S.M	320	480	121	4	17,7	0,25	3	4,5	2,9	4000	2050
24064EA.S.M	320	480	160	4	12,2	0,33	2	3	2	5400	2720
23164EA.S.M	320	540	176	5	23,5	0,33	2,1	3,1	2	6000	3200
24164EA.S.M	320	540	218	5	12,2	0,42	1,6	2,4	1,6	7400	3800
22264EA.S.M	320	580	150	5	23,5	0,28	2,4	3,6	2,4	5000	3100
23264EA.S.M	320	580	208	5	23,5	0,37	1,8	2,7	1,8	7000	3950
23968EA.S.M	340	460	90	3	17,7	0,18	3,8	5,7	3,8	3300	1400
23068EA.S.M	340	520	133	5	23,5	0,25	2,7	4	2,6	4400	2250
24068EA.S.M	340	520	180	5	12,2	0,34	2	3	2	6500	3100
23168EA.S.M	340	580	190	5	23,5	0,33	2	3	2	6900	3600
24168EA.S.M	340	580	243	5	15	0,43	1,6	2,3	1,5	8500	4400
23268EA.S.M	340	620	224	6	23,5	0,37	1,8	2,7	1,8	8100	4500
23972EA.S.M	360	480	90	3	17,7	0,18	3,9	5,7	2,8	3710	1450
23072EA.S.M	360	540	134	5	23,5	0,24	2,8	4,2	2,8	4800	2400
24072EA.S.M	360	540	180	5	15	0,33	2	3	2	6800	3200
23172EA.S.M	360	600	192	5	23,5	0,32	2,1	3,2	2,1	7300	3800
24172EA.S.M	360	600	243	5	15	0,41	1,6	2,4	1,6	8913	4801
23272EA.S.M	360	650	232	6	23,5	0,37	1,8	2,7	1,8	9200	4900
23976EA.S.M	380	520	106	4	17,7	0,19	3,6	5,3	3,5	4120	1980
24976EA.S.M	380	520	140	4	12,2	0,23	2,9	4,3	2,8	5150	2243
23076EA.S.M	380	560	135	5	23,5	0,24	2,8	4,2	2,8	5300	2500
24076EA.S.M	380	560	180	5	15	0,31	2,2	3,2	2,2	7200	3300
23176EA.S.M	380	620	194	5	23,5	0,31	2,2	3,2	2,1	8200	4100
24176EA.S.M	380	620	243	5	15	0,4	1,7	2,5	1,7	9500	4700
23276EA.S.M	380	680	240	6	23,5	0,36	1,9	2,8	1,8	9800	5300
19.38.01	390	650	208	6	–	0,32	2,1	3,1	2	7955	4470
23980EA.S.M	400	540	106	4	17,7	0,18	3,7	5,5	3,6	4600	2300
23080EA.S.M	400	600	148	5	23,5	0,25	2,7	4	2,6	6200	3100
24080EA.S.M	400	600	200	5	15	0,33	2	3	2	8470	4140
23180EA.S.M	400	650	200	6	23,5	0,31	2,2	3,3	2,2	8500	4200
24180EA.S.M	400	650	250	6	15	0,39	1,7	2,6	1,7	10500	5200
22280EA.S.M	400	720	185	6	23,5	0,27	2,5	3,7	2,4	7000	4000
23280EA.S.M	400	720	256	6	23,5	0,35	2	2,9	1,9	10800	5700
22380EA.S.M	400	820	243	7,5	23,5	0,33	2,1	3,1	2	10500	6600
23984EA.S.M	420	560	106	4	17,7	0,18	3,9	5,7	3,8	4700	2250
23084EA.S.M	420	620	150	5	23,5	0,24	2,8	4,2	2,8	6600	3200
24084EA.S.M	420	620	200	5	15	0,31	2,2	3,2	2,2	8745	4200
23184EA.S.M	420	700	224	6	23,5	0,32	2,1	3,2	2,1	9700	5000
24184EA.S.M	420	700	280	6	15	0,41	1,7	2,5	1,6	12400	6400
23284EA.S.M	420	760	272	7,5	23,5	0,37	1,8	2,7	1,8	12500	6600
23988EA.S.M	440	600	118	4	23,5	0,18	3,7	5,5	3,6	5500	2600
23088EA.S.M	440	650	157	6	23,5	0,24	2,8	4,2	2,8	7219	3614

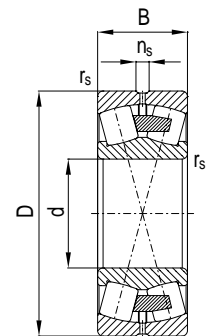

222, 223, 231, 232, 240, 241

	Ermüdungs-grenzbelastung	Grenzdrehzahl	Bezugsdrehzahl	Gewicht
	Fatigue stress limit	Limiting speed	Reference speed	Weight
	C_u kN	n_g min ⁻¹	n_{th} min ⁻¹	kg
	415	1300	830	79,5
	570	1000	720	106
	612	1100	670	171
	782	860	390	205
	528	650	590	180
	739	930	570	247
	290	1200	900	44,7
	465	1200	770	105
	687	1000	670	143
	682	1000	630	216
	898	810	350	266
	856	860	530	305
	306	1200	850	47
	507	1100	710	111
	718	970	640	150
	755	990	580	228
	951	760	320	279
	972	730	490	347
	389	1100	790	70,5
	545	610	–	92
	560	1100	670	117
	761	930	590	157
	831	950	540	242
	1003	780	300	290
	1035	710	460	390
	840	900	–	329
	420	1100	740	72,9
	655	1000	630	152
	898	850	600	202
	898	900	510	270
	1109	750	280	326
	739	510	320	343
	1069	640	440	465
	1109	660	440	649
	452	1000	700	77,1
	697	990	570	160
	930	850	500	214
	994	690	480	362
	1352	670	260	443
	1320	610	410	541
	485	1000	650	104
	750	920	530	184

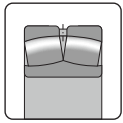

Pendelrollenlager
Spherical Roller Bearings, Double Row

Kurzzeichen	Abmessung					Faktor				Tragzahl	
										stat.	dyn.
Code	Dimension					Factor				Load rating	
										stat.	dyn.
	d mm	D mm	B mm	r _{s min} mm	n _s mm	e	Y ₁	Y ₂	Y ₀	C ₀ kN	C kN
24088EA.S.M	440	650	212	6	15	0,32	2,1	3,1	2,1	9700	4300
23188EA.S.M	440	720	226	6	23,5	0,31	2,2	3,2	2,1	10400	5200
24188EA.S.M	440	720	280	6	17,7	0,39	1,7	2,6	1,7	13500	6500
23288EA.S.M	440	790	280	7,5	23,5	0,37	1,8	2,7	1,8	13500	7200
23992EA.S.M	460	620	118	4	23,5	0,18	3,8	5,6	3,7	5500	2600
23092EA.S.M	460	680	163	6	23,5	0,24	2,8	4,2	2,8	7700	3700
24092EA.S.M	460	680	218	6	17,7	0,31	2,2	3,2	2,2	10600	4800
23192EA.S.M	460	760	240	7,5	23,5	0,32	2,1	3,2	2,1	11600	5900
24192EA.S.M	460	760	300	7,5	17,7	0,37	1,8	2,7	1,8	14160	7180
23292EA.S.M	460	830	296	7,5	23,5	0,37	1,8	2,7	1,8	15000	7800
23996EA.S.M	480	650	128	5	23,5	0,18	3,7	5,5	3,6	6251	2901
23096EA.S.M	480	700	165	6	23,5	0,23	3	4,4	2,9	8200	3800
24096EA.S.M	480	700	218	6	17,7	0,3	2,3	3,4	2,2	11500	4900
23196EA.S.M	480	790	248	7,5	23,5	0,31	2,2	3,2	2,1	13000	6300
24196EA.S.M	480	790	308	7,5	17,7	0,4	1,7	2,5	1,7	15712	7646
23296EA.S.M	480	870	310	7,5	23,5	0,37	1,8	2,7	1,8	16000	8800
19.49.01	498,5	720	167	6	23,5	0,22	3,1	4,6	3	7654	3800
239/500EA.S.M	500	670	128	5	23,5	0,18	3,8	5,6	3,7	6500	3000
230/500EA.S.M	500	720	167	6	23,5	0,22	3,1	4,6	3	8500	3900
240/500EA.S.M	500	720	218	6	17,7	0,29	2,3	3,5	2,2	12100	4900
231/500EA.S.M	500	830	264	7,5	23,5	0,32	2,1	3,2	2,1	14500	7200
241/500EA.S.M	500	830	325	7,5	17,7	0,36	1,9	2,8	1,8	17400	8365
232/500EA.S.M	500	920	336	7,5	23,5	0,38	1,8	2,6	1,7	17000	8800
239/530EA.S.M	530	710	136	5	23,5	0,18	3,8	5,6	3,7	6800	3000
230/530EA.S.M	530	780	185	6	23,5	0,23	3	4,4	2,9	9500	4400
240/530EA.S.M	530	780	250	6	17,7	0,3	2,3	3,4	2,2	13500	6000
231/530EA.S.M	530	870	272	7,5	23,5	0,31	2,2	3,2	2,1	15500	7400
241/530EA.S.M	530	870	335	7,5	17,7	0,39	1,7	2,6	1,7	19480	9260
239/560EA.S.M	560	750	140	5	23,5	0,18	3,9	5,7	3,8	7800	3600
230/560EA.S.M	560	820	195	6	23,5	0,23	3	4,4	2,9	11000	5100
240/560EA.S.M	560	820	258	6	17,7	0,3	2,3	3,4	2,2	14500	6400
231/560EA.S.M	560	920	280	7,5	23,5	0,31	2,2	3,3	2,2	16500	8100
241/560EA.S.M	560	920	355	7,5	23,5	0,39	1,7	2,6	1,7	22000	10400
239/600EA.S.M	600	800	150	5	23,5	0,18	3,9	5,7	3,8	9100	3700
230/600EA.S.M	600	870	200	6	23,5	0,22	3,1	4,6	3	12500	5700
240/600EA.S.M	600	870	272	6	17,7	0,3	2,3	3,4	2,2	16600	7100
231/600EA.S.M	600	980	300	7,5	23,5	0,31	2,2	3,3	2,2	19500	9000
241/600EA.S.M	600	980	375	7,5	23,5	0,39	1,7	2,6	1,7	23600	11500
239/630EA.S.M	630	850	165	6	23,5	0,18	3,8	5,6	3,7	9800	3900
230/630EA.S.M	630	920	212	7,5	23,5	0,22	3	4,5	2,9	14000	6500
240/630EA.S.M	630	920	290	7,5	17,7	0,3	2,3	3,4	2,2	19000	8000
231/630EA.S.M	630	1030	315	7,5	23,5	0,31	2,2	3,3	2,2	21000	10500

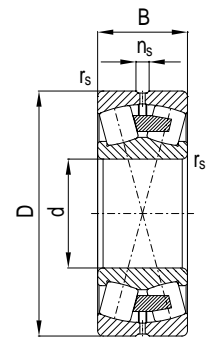

222, 223, 231, 232, 240, 241

Ermüdungs- grenzbelastung	Grenzdrehzahl	Bezugsdrehzahl	Gewicht
Fatigue stress limit	Limiting speed	Reference speed	Weight
C_u kN	n_g min ⁻¹	n_{th} min ⁻¹	kg
1025	800	480	249
1080	810	450	379
1426	670	240	454
1426	570	390	607
519	960	610	107
813	880	520	210
1120	760	460	278
1169	760	430	452
1498	640	200	578
1584	540	370	717
554	950	570	128
832	860	500	220
1150	710	430	288
1262	710	400	504
1675	600	210	639
1650	510	350	835
760	820	480	237
589	900	540	133
845	820	480	229
1183	660	410	297
1357	670	380	600
1755	570	200	754
1690	480	330	1010
612	860	500	159
855	760	430	310
1215	630	380	415
1395	640	360	667
1800	530	180	839
699	810	460	183
990	720	410	358
1305	590	360	470
1485	600	330	768
2025	480	170	979
776	730	420	221
1125	680	380	406
1485	530	320	550
1755	530	310	934
2340	460	150	1180
835	690	390	282
1260	640	350	488
1710	500	300	662
1890	500	260	1070

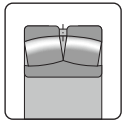

Pendelrollenlager
Spherical Roller Bearings, Double Row

Kurzzeichen	Abmessung					Faktor				Tragzahl	
										stat.	dyn.
Code	Dimension					Factor				Load rating	
										stat.	dyn.
	d mm	D mm	B mm	r _{s min} mm	n _s mm	e	Y ₁	Y ₂	Y ₀	C ₀ kN	C kN
241/630EA.S.M	630	1030	400	7,5	23,5	0,39	1,7	2,6	1,7	29000	13000
248/670EA.S.M	670	820	150	4	15	0,16	4,1	6,2	4,1	10500	3900
239/670EA.S.M	670	900	170	6	23,5	0,18	3,9	5,7	3,8	11250	4995
249/670EA.S.M	670	900	230	6	23,5	0,24	3,1	4,6	3	15000	6000
19.67.01	670	980	230	7,5	23,5	0,21	3,2	4,7	3,1	14600	7650
230/670EA.S.M	670	980	230	7,5	23,5	0,25	2,7	4	2,6	16000	7500
240/670EA.S.M	670	980	308	7,5	17,7	0,3	2,3	3,4	2,2	21000	8850
248/710EA.S.M	710	870	160	4	15	0,16	4,1	6,3	4,1	11000	4000
239/710EA.S.M	710	950	180	6	23,5	0,18	3,9	5,7	3,8	12500	5500
249/710EA.S.M	710	950	243	6	23,5	0,24	2,8	4,2	2,8	16300	6400
230/710EA.S.M	710	1030	236	7,5	23,5	0,22	3,1	4,6	3	17500	7700
240/710EA.S.M	710	1030	315	7,5	17,7	0,3	2,3	3,4	2,2	23000	9500
241/710EA.S.M	710	1150	438	9,5	23,5	0,36	1,9	2,8	1,9	34500	15360
248/750EA.S.M	750	920	170	5	15	0,16	4,1	6,1	4	11820	4080
239/750EA.S.M	750	1000	185	6	23,5	0,17	4	5,9	3,9	14000	5800
249/750EA.S.M	750	1000	250	6	23,5	0,24	3,2	4,8	3,1	18500	7200
240/750EAM.S.M	750	1090	335	7,5	23,5	0,28	2,4	3,6	2,5	24700	10000
248/800EAM.S.M	800	980	180	5	15	0,15	4,5	6,7	4,5	12600	4120
239/800EAM.S.M	800	1060	195	6	23,5	0,16	4,2	6,3	4	14300	5600
240/800EAM.S.M	800	1150	345	7,5	23,5	0,27	2,5	3,7	2,5	28200	11000
248/850EAM.S.M	850	1030	180	5	15	0,15	4,4	6,6	4,3	14300	4430
239/850EAM.S.M	850	1120	200	6	23,5	0,16	4,2	6,3	4	15300	5880
248/900EAM.S.M	900	1090	190	5	15	0,14	4,8	7,2	4,5	15000	4640
239/900EAM.S.M	900	1180	260	6	23,5	0,15	4,5	6,7	4,5	16700	6340

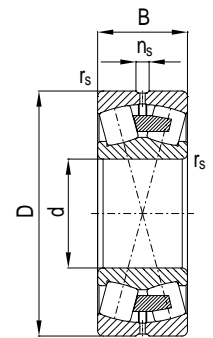

222, 223, 231, 232, 240, 241

Ermüdungs-grenzbelastung	Grenzdrehzahl	Bezugsdrehzahl	Gewicht
Fatigue stress limit	Limiting speed	Reference speed	Weight
C_u kN	n_g min^{-1}	n_{th} min^{-1}	kg
2610	430	140	1410
794	630	360	178
917	640	340	326
1411	350	–	435
1314	600	320	149
1440	600	320	602
1890	470	290	802
832	590	340	217
1001	590	310	386
1530	330	–	507
1575	560	300	670
2070	420	250	889
2600	380	–	1900
983	550	330	255
1040	550	280	420
1742	320	–	575
2100	400	230	1065
953	500	300	290
1059	500	240	470
2133	380	210	1200
1081	470	270	324
1157	460	210	560
1134	430	240	355
1263	430	190	605

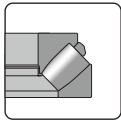

Axial-Pendelrollenlager
Spherical Roller Thrust Bearings

Kurzzeichen	Abmessung									Tragzahl	
										stat.	dyn.
Code	Dimension									Load rating	
										stat.	dyn.
	d mm	d ₁ mm	D mm	D ₁ mm	T mm	T ₁ mm	T ₂ mm	A ≈	r _{s min} mm	C ₀ kN	C kN
29240E.MB	200	265	280	235	48	23	15	108	2	2650	654
29244E.MB	220	285	300	254	48	23	15	117	2	3100	705
29248E.MB	240	320	340	282	60	29	19	130	2,1	3800	880
29252E.MB	260	340	360	302	60	29	19	139	2,1	4060	900
29352E.MB	260	385	420	327	95	44	32	148	5	7900	2250
29452E.MB	260	435	480	353	132	63	48	154	6	11800	3500
29256E.MB	280	360	380	322	60	29	19	150	2,1	4400	950
29356E.MB	280	405	440	346	95	45	32	158	5	8500	2300
29456E.MB	280	470	520	380	145	67	52	166	6	14000	4100
29260E.MB	300	395	420	353	73	37	21	162	3	5361	1190
29360E.MB	300	440	480	378	109	49	37	168	5	10100	2800
29460E.MB	300	490	540	398	145	69	52	175	6	15100	4100
29264E.MB	320	415	440	372	73	37	21	172	3	5654	1260
29364E.MB	320	465	500	396	109	52	37	180	5	10800	2900
29464E.MB	320	525	580	432	155	74	56	191	7,5	17000	4600
29268E.MB	340	435	460	391	73	36	21	183	3	6032	1350
29368E.MB	340	500	540	426	122	58	41	192	5	11800	2900
29468E.MB	340	560	620	458	170	81	61	201	7,5	20450	5500
29272E.MB	360	475	500	423	85	43	25	194	4	7514	1600
29372E.MB	360	520	560	446	122	58	41	202	5	12360	3000
29472E.MB	360	580	640	475	170	81	61	210	7,5	20700	5370
29276E.MB	380	490	520	440	85	41	27	202	4	7700	1790
29376E.MB	380	555	600	474	132	62	44	216	6	14900	3600
29476E.MB	380	610	670	500	175	84	63	230	7,5	23150	5860
29280E.MB	400	510	540	460	85	41	27	212	4	8800	1840
29380E.MB	400	575	620	493	132	63	44	225	6	15500	3700
29480E.MB	400	645	710	530	185	88	67	236	7,5	25700	6480
29284E.MB	420	550	580	489	95	45	30	225	5	10800	2200
29384E.MB	420	600	650	520	140	67	48	235	6	16900	4000
29484E.MB	420	665	730	550	185	88	67	244	7,5	26700	6710
29288E.MB	440	570	600	506	95	48	30	235	5	11470	2300
29388E.MB	440	630	680	548	145	69	49	245	6	19100	4500
29488E.MB	440	710	780	585	206	99	74	260	9,5	30940	7730
29292E.MB	460	590	620	528	95	45	30	245	5	11700	2350
29392E.MB	460	660	710	567	150	71	51	257	6	20000	4600
29492E.MB	460	730	800	605	206	99	74	272	9,5	32150	7900
29296E.MB	480	620	650	556	103	54	33	259	5	12800	2550
29396E.MB	480	675	730	587	150	71	51	270	6	20800	4700
29496E.MB	480	770	850	630	224	107	81	280	9,5	37660	9210
292/500E.MB	500	640	670	574	103	54	33	268	5	13600	2600
293/500E.MB	500	700	750	610	610	73	51	280	6	21500	5100
294/500E.MB	500	790	870	654	224	106	81	290	9,5	38700	9340

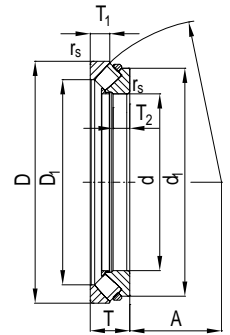

292, 293, 294

Ermüdungs-grenzbelastung	Grenzdrehzahl	Bezugsdrehzahl	Gewicht
Fatigue stress limit	Limiting speed	Reference speed	Weight
C_u kN	n_g min ⁻¹	n_{th} min ⁻¹	kg
200	2100	1265	9,08
215	1950	1145	9,84
245	1770	1045	17,1
255	1690	965	18,5
490	1250	820	51,5
725	1000	740	110
270	1520	890	19,5
515	1160	755	54,7
825	930	670	142
310	1420	825	31
590	1090	650	75,5
880	870	620	148
325	1330	775	32,8
620	1025	610	79,5
970	820	580	185
340	1260	725	34,5
665	955	600	106
1125	780	540	230
400	1200	685	50,5
690	905	575	111
1140	740	490	234
410	1050	640	52,8
800	860	540	140
1250	700	470	263
455	1080	610	55,1
825	820	510	146
1370	665	445	314
540	1024	585	74,9
890	780	480	170
1415	635	415	325
570	980	555	79
990	755	465	192
1615	610	390	421
580	940	530	80,9
1030	725	435	216
1670	580	375	435
625	900	505	97,5
1065	700	415	224
1925	560	355	543
660	880	485	101
1095	670	395	231
1970	540	340	559

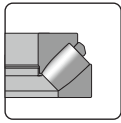

Axial-Pendelrollenlager
Spherical Roller Thrust Bearings

Kurzzeichen	Abmessung									Tragzahl	
										stat.	dyn.
Code	Dimension									Load rating	
										stat.	dyn.
	d mm	d ₁ mm	D mm	D ₁ mm	T mm	T ₁ mm	T ₂ mm	A ≈	r _{s min} mm	C ₀ kN	C kN
292/530E.MB	530	675	710	612	109	56	35	288	5	15600	3090
293/530E.MB	530	745	800	646	160	75	54	295	7,5	24900	5600
294/530E.MB	530	840	920	690	236	113	87	309	9,5	42680	10350
292/560E.MB	560	715	750	642	115	59	37	302	5	17200	3250
293/560E.MB	560	790	850	690	175	84	60	310	7,5	27680	6700
294/560E.MB	560	890	980	729	250	119	90	328	12	50000	11900
292/600E.MB	600	760	800	688	122	64	39	321	5	19400	3800
293/600E.MB	600	840	900	727	180	86	61	335	7,5	32500	7360
294/600E.MB	600	940	1030	782	258	126	92	347	12	53900	12600
292/630E.MB	630	805	850	724	132	66	42	338	6	22000	4350
293/630E.MB	630	885	950	765	190	91	65	345	9,5	36500	8280
294/630E.MB	630	995	1090	820	280	135	100	365	12	60100	14210
292/670E.MB	670	885	900	773	140	73	45	364	6	24000	4650
294/670E.MB	670	1050	1150	869	290	137	104	387	15	65900	15190
292/710E.MB	710	905	950	815	145	74	46	380	6	28500	5600
293/710E.MB	710	990	1060	861	212	101	72	394	9,5	46000	9760
294/710E.MB	710	1115	1220	916	308	149	111	415	15	75730	17500
292/750E.MB	750	955	1000	861	150	80	48	406	6	31500	5800
293/750E.MB	750	1045	1120	909	224	107	76	415	9,5	47800	10300
292/800E.MB	800	1010	1060	913	155	80	50	426	7,5	36000	6540
293/800E.MB	800	1100	1180	961	230	111	78	440	9,5	53600	11350
292/850E.MB	850	1065	1120	963	160	81	51	453	7,5	39500	7050
293/850E.MB	850	1165	1250	1021	243	117	85	468	12	61000	12400
292/900E.MB	900	1125	1180	1023	170	83	54	477	7,5	43000	8000
292/950E.MB	950	1190	1250	1079	180	89	58	507	7,5	48000	8650

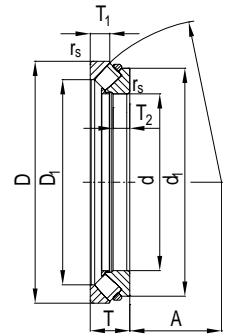

292, 293, 294

Ermüdungs-grenzbelastung	Grenzdrehzahl	Bezugsdrehzahl	Gewicht
Fatigue stress limit	Limiting speed	Reference speed	Weight
C_u kN	n_g min ⁻¹	n_{th} min ⁻¹	kg
740	840	456	120
1245	640	370	283
2155	510	315	657
810	800	430	141
1370	607	350	353
2495	485	300	797
900	720	400	168
1585	570	325	399
2675	452	275	891
1010	680	380	212
1760	545	305	473
2965	431	255	1090
1095	650	360	249
3230	405	240	1250
1280	600	335	285
2185	490	270	647
3690	390	225	1490
1410	580	320	323
2265	460	250	763
1595	530	300	369
2525	440	235	852
1745	510	280	419
2855	420	220	1010
1890	480	265	488
2100	440	250	585



Tradition und Erfahrung

Die Entwicklung und Produktion von Standard- und Sonderwälzlagern am Standort Leipzig hat eine mehr als hundertjährige Tradition.

Die Erfahrung in der Konstruktion von Mittel- und Großlagern erwuchs aus einer kontinuierlich verbesserten Fertigungstechnologie.

Dieses fundierte Know-how, gerade im Sondertypenbau, macht die KRW Leipzig GmbH zu Ihrem Partner für die Auslegung von Lagersystemen in den verschiedensten Anwendungsbereichen.

KRW-Wälzlager sind weltweit im Einsatz:

- Schwerindustrie
- Bahn & Transportwesen
- Energie & Kraftwerke
- Maschinenbau
- Schiffbau & Hafentechnologie

Technische Beratung

Die KRW Leipzig GmbH unterstützt Sie beim Finden der richtigen Lagerungsmethode und assistiert bei der Bemessung und der Berechnung zur Belastung und Lebensdauer von Wälzlagern. Darüber hinaus leistet die KRW Leipzig GmbH konkrete Hilfestellung beim Einbau und unterstützt Sie bei der Wartung von Wälzlagern in Ihrer Applikation.

Realisieren Sie gemeinsam mit den KRW-Ingenieuren die optimale Lösung für Ihren Einsatzfall.

Ihr KRW-Entwicklungsteam

Tradition and Experience

The development and production of standard and special roller bearings in Leipzig has more than one hundred years of tradition.

The experience in the construction of medium size and large size bearings grew out of a continuously improved production technology.

This know-how, especially in special bearing construction, qualifies KRW Leipzig GmbH as your partner for designing bearing systems in different application fields.

KRW roller bearings are used worldwide:

- Heavy Industry
- Rail & Transportation
- Energy & Power Plants
- Engineering
- Shipbuilding & Port Technology

Technical support

KRW Leipzig GmbH supports you in finding the correct bearing method and assists you in assessing and calculating the load capacity of roller bearings. In addition, KRW Leipzig GmbH provides concrete assistance in the installation and supports you in the maintenance of roller bearings in your application.

Identify together with the KRW-engineers the optimum solution for your application.

Your KRW development team



Prototypenbau

Die KRW Leipzig GmbH konstruiert mittels computergestützter 3D Programme virtuelle Prototypen, anhand derer die Fertigungsmaterialien definiert und wichtige Daten als Berechnungsgrundlage für Bemessungswerte und Tragzahlen gewonnen werden können. Anschließend werden Prototypen-Echtlager gefertigt, welche in der Zielanwendung oder einer vergleichbaren Belastungssituation zur Probe verbaut werden, um weitere Kennziffern ableiten zu können.

Schmierstoffempfehlungen und Wärmebilanzen

Durch eine enge Zusammenarbeit und gemeinsame Forschungsprojekte mit Partnern aus der Schmierstoffindustrie kann schon während der Konstruktion eines Lagers die optimale Materialauswahl erfolgen und eine adäquate Schmierungsart bestimmt werden.

Lebensdauerberechnungen

Die KRW Leipzig GmbH bietet für alle Lagertypen eine individuelle und das Einsatzgebiet berücksichtigende Lebens- bzw. Nutzungsdauerberechnung an. Mit dieser kann schon vor Inbetriebnahme einer Anwendung die Wirtschaftlichkeit und Standzeit dieser Applikation sehr zuverlässig angegeben werden.

Rekonditionierung

Der Begriff „Rekonditionierung“ beschreibt einen Wiederherstellungsprozess. Hierbei wird ein gebrauchtes, unter Umständen auch beschädigtes Lager, durch mechanische Bearbeitung bzw. durch den Austausch einzelner Lagerkomponenten so aufbereitet, dass es ohne Leistungsverlust und ohne Beeinträchtigung der originalen Tragzahlen in der ursprünglichen Applikation wiederverwendet werden kann. Die Nutzungsdauer bestimmter Wälzlager kann durch eine Rekonditionierung deutlich erhöht werden. Weitere Vorteile sind die geringeren Wiederbeschaffungskosten (ca. 60 %) sowie ein wesentlich kürzerer Lieferzeitraum als bei einer Neufertigung.

Prototype building

KRW Leipzig GmbH is using computer based 3D programs for the virtual construction of prototypes. With this method, you can define the sort of material the roller bearing should be made of. Additionally important data for calculation of design values and load ratings can be obtained. Then a prototype will be manufactured, which must run in the asked application or a similar stress situation. Through this procedure other parameter can be derived.

Preparation of recommended lubrication and heat balances

Through close cooperation and joint research projects with partners from the lubricant industry you already can determine the optimal choice of materials and adequate lubrication just during the construction process of a bearing.

Lifetime calculations

KRW Leipzig GmbH offers an individual lifetime calculation for all types of bearings with simultaneous consideration to the application field which the roller bearing will be made for. This can show efficiency and reliability of the roller bearings even before they are working in an application.

Reconditioning

The term „reconditioning“ describes a recovery process. A used or even damaged roller bearing is prepared by machining or by a replacement of single bearing components so that it can be reused without loss of performance and without affecting the original load ratings in the original application. The operating life of certain bearings can be increased significantly by performing a reconditioning. Other advantages are the low replacement costs (60 % of a remanufacturing) and a much shorter delivery period.

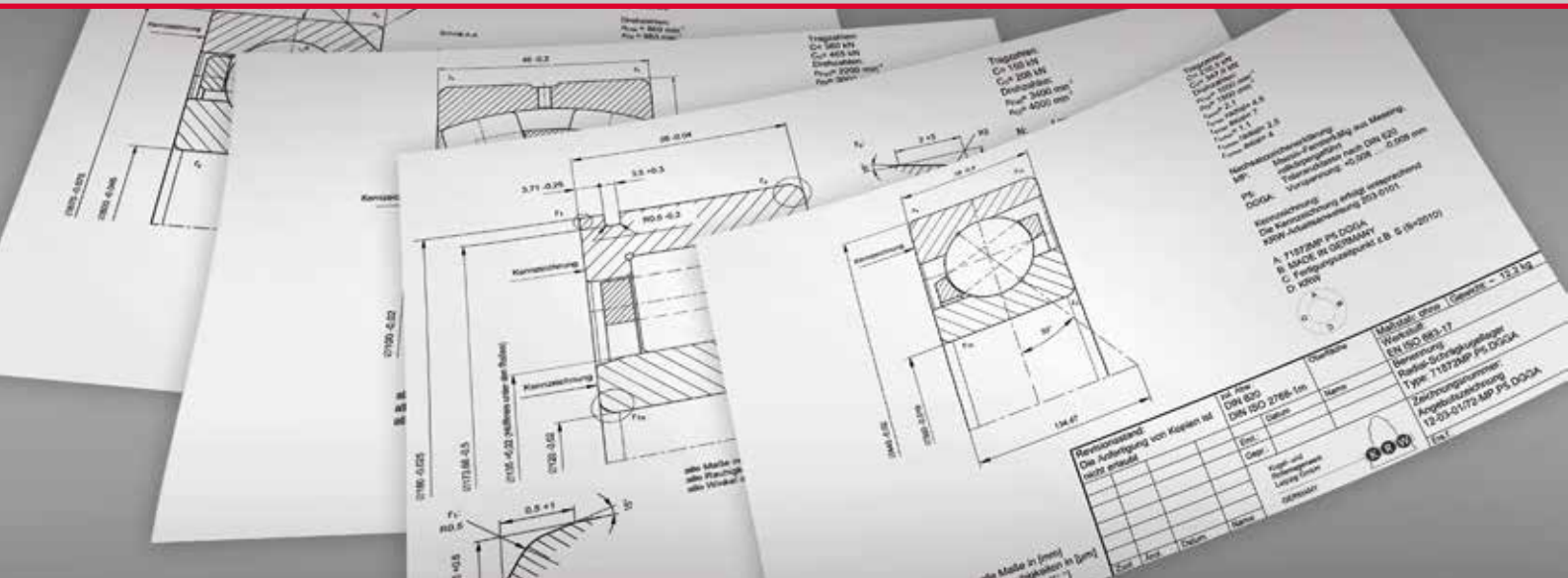

KRW	Benennung	Naming	FAG	SKF	NSK
A	geänderte Innenkonstruktion	Modified internal design		A	
A..	in Verbindung mit Zahlenangabe Axialluft abweichend von DIN 620	Combined with a number, indicates axial clearance deviating from DIN 620	A.		CA...
ALP	Massiv-Fensterkäfig aus Aluminium, wälzkörpergeführt	Machined window-type cage, aluminium, rolling element riding	LP		
ALPA	Massiv-Fensterkäfig aus Aluminium, versilbert, Führung am Außenring	Machined window-type cage, aluminium, silver-plated, inner ring riding	LPA	LA	
AGFP	Massiv-Fensterkäfig aus Stahl, versilbert, wälzkörpergeführt	Machined window-type cage, steel, silver-plated, rolling element riding	FP...		
AGFPB	Massiv-Fensterkäfig aus Stahl, versilbert, Führung am Innenring	Machined window-type cage, steel, silver-plated, inner ring riding	FPB...		
B	geänderte Innenkonstruktion, bei Radialschrägkugellagern, Kontaktwinkel 40°	Modified internal design of radial angular contact ball bearings, contact angle 40°	B	B	B
BL	ballige Laufbahn für den Innenring	Crowned inner ring raceway	BL		
C1NA	bei zweireihigen Zylinderrollenlagern Luftgruppe C1, Ringe nicht austauschbar	Clearance group C1 in double row cylindrical roller bearings, rings not exchangeable	C1NA		CC1
C2	Luftgruppe C2, Lagerluft kleiner als CN	Clearance group C2, clearance smaller than CN	C2	C2	C2
CN	Luftgruppe CN, normale Lagerluft	Clearance group CN, normal clearance	CN	CN...	CN
C3	Luftgruppe C3, Lagerluft größer als CN	Clearance group C3, clearance larger than CN	C3	C3	C3
C4	Luftgruppe C4, Lagerluft größer als C3	Clearance group C4, clearance larger than C3	C4	C4	C4
C5	Luftgruppe C5, Lagerluft größer als C4	Clearance group C5, clearance larger than C4	C5	C5	C5
C4H	Lagerluft auf den oberen Teil der Luftgruppe C4 eingeschränkt	Clearance restricted to the upper range of clearance group C4		C4H	
C3M	Lagerluft auf den mittleren Teil der Luftgruppe C3 eingeschränkt	Clearance restricted to the medium range of clearance group C3		C3H	
C2L	Lagerluft auf den unteren Teil der Luftgruppe C2 eingeschränkt	Clearance restricted to the lower range of clearance group C2		C2L	
DB	Axialluft bei zwei einreihigen Rillenkugellagern, Schrägkugellagern oder Kegellagern in O-Anordnung; darauffolgende Buchstabenkombinationen kennzeichnen die Größe der axialen Lagerluft	Axial clearance with two deep groove ball bearings, angular contact ball bearings or tapered roller bearings in O arrangement. The next letters specify the amount of axial clearance		DB	
A	Leichte Vorspannung (Schrägkugellager)	A Light preload (angular contact ball bearings)			
B	Vorspannung > A (Schrägkugellager)	B Preload > A (angular contact ball bearings)			
C	Vorspannung > B (Schrägkugellager)	C Preload > B (angular contact ball bearings)			
CA	Kleine Axialluft (Rillen- und Schrägkugellager)	CA Small axial clearance (deep groove ball bearings and angular contact ball bearings)			
CB	Axialluft > CA (Rillen- und Schrägkugellager)	CB Axial clearance > CA (deep groove ball bearings and angular contact ball bearings)			

KRW	Benennung	Naming	FAG	SKF	NSK
DB	CC Axialluft > CB (Rillen- und Schrägkugellager)	CC Axial clearance > CB (deep groove ball bearings and angular contact ball bearings)		DB	
	CG Lagerluft „Null“ (Kegelrollenlager)	CG Zero axial clearance (tapered roller bearings)			
	C.. Spezielle Axialluft in µm	C.. Special axial clearance in µm			
	GA Leichte Vorspannung (Rillenkugellager)	GA Light preload (deep groove ball bearings)			
	GB Vorspannung größer als GA (Rillenkugellager)	GB Preload > GA (deep groove ball bearings)			
	G.. Spezielle Vorspannung in daN	G.. Special preload in daN			
DF	zwei einreihige Rillenkugellager, Schrägkugellager oder Kegelrollenlager für den paarweisen Einbau in X-Anordnung; ansonsten wie unter DB	Two single row deep groove ball bearings, angular contact ball bearings or tapered roller bearings for mounting in pairs (X arrangement); for preloads and clearances, see list under DB	DF	DF	DF
DG	zwei einreihige Schrägkugellager für den beliebigen Einbau in O-, X- oder Tandemanordnung; ansonsten wie unter DB	Two single row angular contact ball bearings for mounting in O, X or tandem arrangement; for preloads and clearances, see list under DB		DG	
DH	einseitig wirkende Axiallager mit zwei Gehäusescheiben	Single direction axial bearings with two housing washers		DH	
DHP	Kombinationsbezeichnung für DH + DP	Combination of suffixes DH + DP		DHP	
DP	Bohrungsdurchmesser der Gehäusescheibe kleiner als normal	Housing washer bore diameter smaller than normal		DP	
DR	zwei Rillenkugellager oder Zylinderrollenlager zur gleichzeitigen Aufnahme der Radiallast	Two deep groove ball bearings or cylindrical roller bearings for simultaneous accommodation of the radial load		DR	DR
DT	zwei einreihige Rillenkugellager, Schrägkugellager oder Kegelrollenlager für den paarweisen Einbau in Tandem-Anordnung; ansonsten wie unter DB, bei Kegelrollenlagern sind hierdurch die Zwischenringe gekennzeichnet	Two single row deep groove ball bearings, angular contact ball bearings or tapered roller bearings for mounting in tandem arrangement; for preloads and clearances, see list under DB, with tapered roller bearings, this refers to the spacer rings		DT	DT
E	Ausführung mit erhöhter Tragzahl	Maximum capacity design	E	E	E
EA	Ausführung mit erhöhter Tragzahl in Verbindung mit veränderter Innenkonstruktion	Maximum capacity design combined with modified internal design		EC	
F	Massivkäfig aus Stahl, wälzkörpergeführt	Machined steel cage, rolling element riding	F...	F...	F
FA	Massivkäfig aus Stahl, Führung am Außenring	Machined steel cage, outer ring riding	FA	FA	
FB	Massivkäfig aus Stahl, Führung am Innenring	Machined steel cage, inner ring riding	FB	FB	
FP	Massiv-Fensterkäfig aus Stahl	Machined window-type steel cage	FP	FP	
FV..	Nachsetzzeichen in Verbindung mit einer Ziffer legt eine spezielle KRW-Fertigungsvorschrift fest	Combined with a number, suffixes indicate a special KRW manufacturing standard			
HB	Härtung bainitisch	Bainitic hardening			
HC	Hybridlager	Hybrid bearing			
HPA	Massiv-Fensterkäfig aus Bronze, Führung am Außenring	Machined window-type bronze cage, outer ring riding			
J	Blechkäfig aus Stahl, wälzkörpergeführt	Pressed steel cage, rolling element riding	J	J	J
K	kegelige Lagerbohrung, Kegel 1:12	Tapered bearing bore, taper 1 : 12	K	K	K
K30	kegelige Lagerbohrung, Kegel 1:30	Tapered bearing bore, taper 1 : 30	K30	K30	K30
M	Massivkäfig aus Messing, wälzkörpergeführt	Machined brass cage, roller riding	M	M	MR
MA	Massivkäfig aus Messing, Führung am Außenring	Machined brass cage, outer ring riding	MA	MA	
MB	Massivkäfig aus Messing, Führung am Innenring	Machined brass cage, inner ring riding		MB	
M2	Massivkäfig aus Messing, warmverniert (Stahlniet), wälzkörpergeführt	Machined brass cage, hot riveted (steel rivets), rolling element riding			
M2A	Massivkäfig aus Messing, warmverniert (Stahlniet), Führung am Außenring	Machined brass cage, hot riveted (steel rivets), outer ring riding			
M2B	Massivkäfig aus Messing, warmverniert (Stahlniet), Führung am Innenring	Machined brass cage, hot riveted (steel rivets), inner ring riding			
M2AS	Massivkäfig aus Messing, warmverniert (Stahlniet), Führung am Außenring, Schmiernuten am Außendurchmesser des Käfigs	Machined brass cage, hot riveted (steel rivets), outer ring riding, lubricating grooves in the cage outside diameter			
M2BS	Massivkäfig aus Messing warmverniert (Stahlniet), Führung am Innenring, Schmiernuten am Innendurchmesser des Käfigs	Machined brass cage, hot riveted (steel rivets), inner ring riding, lubricating grooves in the cage inside diameter			

KRW	Benennung	Naming	FAG	SKF	NSK
M3	Massivkäfig aus Messing, stegvernietet, wälzkörpergeführt	Machined brass cage, crosspiece riveted, rolling element riding	M1	M6	MBR
M3A	Massivkäfig aus Messing, stegvernietet, Führung am Außenring	Machined brass cage, crosspiece riveted, outer ring riding	M1A	MA6	MB
M3B	Massivkäfig aus Messing, stegvernietet, Führung am Innenring	Machined brass cage, crosspiece riveted, inner ring riding			
M4	Kammkäfig, verschraubt (nur über Bohrungskennziffer 64)	Prong-type cage, bolted (available only for bore diameters 64 and larger)			
M4A	Kammkäfig, verschraubt, Führung am Außenring (nur über Bohrungskennziffer 64)	Prong-type cage, bolted, outer ring riding (available only for bore diameters 64 and larger)			
MP	Massiv-Fensterkäfig aus Messing, wälzkörpergeführt	Machined window-type cage, brass, roller riding	MP	MR	MA1
MPA	Massiv-Fensterkäfig aus Messing, Führung am Außenring	Machined window-type cage, brass, outer ring riding	MPA	MP	
MPAD	Massivkäfig aus Messing, Führung am Außenring, durch besondere Käfigtaschengometrie kann der Käfig mit den Wälzkörpern aus dem Außenring herausgenommen werden (Drop-roller)	Machined cage, brass, outer ring riding, roller-cage assembly can be removed from the outer ring due to special cage pocket geometry (drop roller design)			
MPAS	Massiv-Fensterkäfig aus Messing, Führung am Außenring, Schmiernuten am Außendurchmesser des Käfigs	Machined window-type cage, brass, outer ring riding, lubricating grooves in cage outside diameter		MPS	
MPB	Massiv-Fensterkäfig aus Messing, Führung am Innenring	Machined window-type cage, brass, inner ring riding	MP	MP	
MPBS	Massiv-Fensterkäfig aus Messing, Führung am Innenring, Schmiernuten am Innendurchmesser des Käfigs	Machined window-type cage, brass, inner ring riding, lubricating grooves in cage inside diameter		MPS	
N	Lager mit Ringnut im Mantel des Außenringes, ohne Sprengring	Bearing with a circular groove for circlip in the outer ring, without circlip	N	N	N
N1	Lager mit Haltenut am Außenring	Bearing with a retaining groove in the outer ring	N1	N1	
N2	Lager mit zwei Haltenuten auf einer Seite am Außenring	Bearing with two retaining grooves on one side of the outer ring	N2	N2	
N3	Lager mit Ringnut auf einer Seite und einer Haltenut auf der anderen Seite am Außenring	Bearing with a circular groove on one side and one retaining groove on the other side	N3		
N4	Lager mit Ringnut auf einer, zwei Haltenuten auf der anderen Seite	Bearing with a circular groove on one side and two retaining grooves on the other side	N4		
N5	Lager mit Ringnut und Haltenut auf gleicher Seite	Bearing with a circular groove and one retaining groove on the same side	N5		
N6	Lager mit Ringnut und zwei Haltenuten auf gleicher Seite	Bearing with a circular groove and two retaining grooves on the same side	N6		
NA	Lagerluftbereich eingeengt, Lagerteile nicht austauschbar	Restricted clearance, bearing components not exchangeable		NA	
NR	Lager mit Ringnut im Mantel des Außenringes, mit Sprengring	Bearing with a circular groove in the outer ring OD, with circlip	NR	NR	NR
P	bei Pendelrollenlagern: geteilter Außenring mit Zwischenring	Split outer ring halves and spacer ring (in spherical roller bearings)	P		
P5	Toleranzklasse nach DIN 620, genauer als P6	Tolerance class to DIN 620, higher precision than P6	P5	P5	P5
P52	Toleranzklasse P5 und Lagerluftgruppe C2	Tolerance class P5 and clearance group C2	P52	P52	P5C2
P6	Toleranzklasse nach DIN 620, genauer als PN	Tolerance class to DIN 620, higher precision than PN		P6	P6
PN	Normaltoleranz, Toleranzklasse nach DIN 620	Standard tolerance, tolerance class to DIN 620		DN	
R90... 120	speziell vereinbarte Radialluft (in diesem Falle Radialluft zwischen 90 und 120 µm)	Customized radial clearance (in this case, radial clearance between 90 and 120 µm)			CG...
S	Lager mit Ringschmiernut und drei Schmierlöchern am Außenring	Bearing with a circular lubricating groove and three lubricating holes in the outer ring		W33	
SJ	stromisoliert	Current insulated			
SJ10	stromisoliert bis 1000 V	Current insulated up to 1000 V	J20A...	VL0241 VL2071	
SJ30	stromisoliert bis 3000 V	Current insulated up to 3000 V	J20C	VL0246	
SP	Toleranzklasse SP für zweireihige Zylinderrollenlager nach DIN 5412-4 und Axial-Schräggugellager zweiseitig wirkend	Tolerance class SP for double row cylindrical roller bearings to DIN 5412-4 and double direction angular contact thrust ball bearings	SP	SP	
+SP	Sprengring nach DIN 5419 wird mitgeliefert	Circlip to DIN 5419 included in delivery			
SN	Lager für Betriebstemperaturen bis maximal 120°C	Bearing for operating temperatures up to 120°C			

KRW	Benennung	Naming	FAG	SKF	NSK
S0	Lager für Betriebstemperaturen bis maximal 150°C	Bearing for operating temperatures up to 150°C	S0	S0	X26
S1	Lager für Betriebstemperaturen bis maximal 200°C	Bearing for operating temperatures up to 200°C	S1	S1	X28
S2	Lager für Betriebstemperaturen bis maximal 250°C	Bearing for operating temperatures up to 250°C	S2	S2	X29
S3	Lager für Betriebstemperaturen bis maximal 300°C	Bearing for operating temperatures up to 300°C	S3	S3	
S4	Lager für Betriebstemperaturen bis maximal 350°C	Bearing for operating temperatures up to 350°C	S4	S4	
S6	Lager mit Ringschmiernut und sechs Schmierlöchern um 60° versetzt am Außenring	Bearing with a circular lubricating groove and six lubricating holes in the outer ring, staggered by 60°		W33X	E2 E4
SIR	Lager mit Ringschmiernut und drei Schmierlöchern um 120° versetzt am Innenring	Bearing with a circular lubricating groove and three lubricating holes in the inner ring, staggered by 120°			E2 E4
SIR6	Lager mit Ringschmiernut und sechs Schmierlöchern um 60° versetzt am Innenring	Bearing with a circular lubricating groove and six lubricating holes in the inner ring, staggered by 60°			
TA	Massivkäfig aus Hartgewebe, Führung am Außenring	Machined laminated plastic cage, outer ring riding	TA		T...
TB	Massivkäfig aus Hartgewebe, Führung am Innenring	Machined laminated plastic cage, inner ring riding	TB		T...
TP	Massivkäfig aus Hartgewebe, wälzkörpergeführt	Machined laminated plastic cage, roller riding	TB		T...
TN	Käfig aus glasfaserverstärktem Polyamid, wälzkörpergeführt	GRP (polyamide) cage, roller riding	TV	P	H
TNH	Käfig aus glasfaserverstärktem Polyamid (Schnappkäfig), wälzkörpergeführt	GRP (polyamide) cage, (snap-type cage), roller riding	TVH	TN...	TNG
TNP	Käfig aus glasfaserverstärktem Polyamid (Fensterkäfig), wälzkörpergeführt	GRP (polyamide) window-type cage, roller riding			
V	vollrollig oder vollkugelig	Cageless (full complement)	V	V	V
VA0.xx	Vorspannung, axial mit Wertangabe 0.xx	Axial preload, magnitude indicated by 0.xx	VA...		
VR0.xx	Vorspannung, radial mit Wertangabe 0.xx	Radial preload, magnitude indicated by 0.xx	VR...		
VH	vollrolliges Zylinderrollenlager mit selbsthaltendem Rollensatz	Cageless cylinder roller bearing with a self-retained roller set	VH	VH	
VG	Laufbahn des Innenrings vorgeschliffen	Rough-ground inner ring raceway		VGS	
W24	Lager mit vier Schmierlöchern am Innenring	Bearing with four lubricating holes in the inner ring			
X	Kegelrollenlager, deren Außenabmessungen internationalen Normen angepasst wurden	Tapered roller bearing, outside dimensions adapted to international standards	X	X	X
XA	Kegelrollenlager in leistungsgesteigerter Ausführung, deren Außenabmessungen internationalen Normen angepasst wurden	Tapered roller bearing, heavy-duty, outside dimensions adapted to international standards			
Y	Blechkäfig aus Messing	Pressed cage, brass			
	Darüber hinaus können kundenspezifische Kurzzeichen vereinbart werden.	Customized letter codes may also be agreed.			

**Hauptsitz**

KRW Leipzig GmbH
Gutenbergstraße 6
04178 Leipzig
GERMANY

Vertrieb

Phone: +49 (0) 341 45320 200
Fax: +49 (0) 341 45320 201
E-Mail: sales@krw.de
Web: www.krw.de

Verwaltung

Phone: +49 (0) 341 45320 0
Fax: +49 (0) 341 45320 601
E-Mail: info@krw.de
Web: www.krw.de

Head Office

KRW Leipzig GmbH
Gutenbergstraße 6
04178 Leipzig
GERMANY

Sales Department

Phone: +49 (0) 341 45320 200
Fax: +49 (0) 341 45320 201
E-Mail: sales@krw.de
Web: www.krw.de

Administration

Phone: +49 (0) 341 45320 0
Fax: +49 (0) 341 45320 601
E-Mail: info@krw.de
Web: www.krw.de



**Verantwortlich für den Inhalt dieser Seiten:**

Kugel- und Rollenlagerwerk Leipzig GmbH
 Dept.: Public Relations
 Gutenbergstraße 6
 04178 Leipzig
 GERMANY

Telefon: +49 (0) 341 45320 250
 E- Mail: info@krw.de

Registergericht: Leipzig

Registernummer: HRB 23541

USt.- Nr.: 255 727 203

Geschäftsführer: Andreas Fitzner
 Andreas Poltsch
 Nico Taubert

Inhaltlich
 Verantwortlicher: Karl Wolter

Grafik Design: Sven Denning

Haftungshinweis

Die Zusammenstellung der Informationen erfolgte mit der gebotenen Sorgfalt. Gleichwohl übernehmen wir keinerlei Haftung, aus welchem Rechtsgrund auch immer, für Fehler bzw. Unvollständigkeiten, da trotz sorgfältiger inhaltlicher Prüfungen Abweichungen insbesondere in Datenblättern im Einzelnen entstehen können bzw. durch Modifizierungen und Upgrades erzwungen werden.

Version: 2014/003

Responsible for the content of these pages:

Kugel- und Rollenlagerwerk Leipzig GmbH
 Dept.: Public Relations
 Gutenbergstraße 6
 04178 Leipzig
 GERMANY

Phone: +49 (0) 341 45320 250
 E-Mail: info@krw.de

Registration court: Leipzig

Registration number: HRB 23541

VAT registration no.: 255 727 203

Managing Director: Andreas Fitzner
 Andreas Poltsch
 Nico Taubert

Responsible according
 to German press law: Karl Wolter

Graphic Design: Sven Denning

Disclaimer

The necessary care has been taken to ensure the correctness of the information in this catalogue. We do not accept any liability for any errors or incompleteness as, despite careful checks of the contents, deviations may occur in individual data sheets or result from product modifications and/or upgrades.

Version: 2014/003

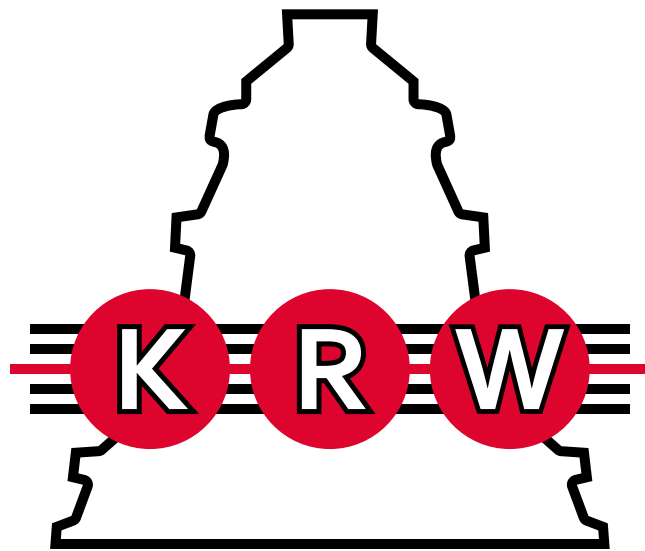

KRW