



OIL SEALS & O-RINGS



JTEKT | JTEKT CORPORATION
KOYO SEALING TECHNO CO., LTD.

CAT. NO.R2001E



OIL SEALS & O-RINGS

- **Koyo Oil Seals: Features**
- **Koyo O-Rings: Features**
- **Koyo Functional Products: Features**
- **FEM (Finite Element Method) Analysis**

1. Oil Seals

Engineering Section

Dimensional Tables

2. O-Rings

Engineering Section

Dimensional Tables

3. Application Examples

of Oil Seals and O-Rings

4. References

Engineering Data

5. Request Forms

for Oil Seal Design and Production

Koyo®

OIL SEALS & O-RINGS

JTEKT | JTEKT CORPORATION
KOYO SEALING TECHNO CO., LTD.

Preface

This catalog lists Koyo oil seals and O-rings, including all items of the dimension series specified in ISO, JIS and JASO (Japanese Automobile Standards Organization) standards. This catalog is also based on knowledge gained from our supply record, experience, expertise, technologies, and research developments that JTEKT and KOYO SEALING TECHNO have acquired in cooperation with customers since its foundation in 1964.

A specialty of this new catalog is the comprehensive information, it offers regarding the selection and handling of oil seals and O-rings.

Energy-saving, efforts to protect global environment are in great demand, and we make efforts to continue further research and development in response to these.

We look forward to receiving your further loyal patronage of Koyo products.

If you have any questions or requests in selecting oil seals, please fill out the Request Forms for Oil Seal Design and Production provided at the end of this catalog and send them by fax to your nearest JTEKT operation.

- ★ The contents of this catalog are subject to change without prior notice. Every possible effort has been made to ensure that the data listed in this catalog is correct. However, we can not assume responsibility for any errors or omissions.

Reproduction of this catalog without written consent is strictly prohibited.

Contents

■ Koyo Oil Seals: Features	2
■ Koyo O-Rings: Features	3
■ Koyo Functional Products: Features	4
■ FEM (Finite Element Method) Analysis	6

1. Oil Seals

1.1 Nomenclature and functions of seal components	8
1.2 Seal numbering system	10
1.3 Seal types	11
1.4 Selection of seal	15
1.5 Shaft and housing design	18
1.6 Seal characteristics	22
1.7 Handling of seal	26
1.8 Causes of seal failures and countermeasures	30
1.9 Seal dimensional tables (Contents)	35

2. O-Rings

2.1 Classification of O-ring and backup ring	88
2.2 Numbering systems of O-ring and backup ring	89
2.3 Selection of O-ring	90
2.4 O-ring technical principles	94
2.5 Fitting groove design for O-ring	96
2.6 Handling of O-ring	98
2.7 Typical O-ring failures, causes and countermeasures	99
2.8 O-ring dimensional tables (Contents)	101

3. Application Examples of Oil Seals and O-Rings

3.1 Automobile	138
3.2 Motorcycle	141
3.3 Rolling mill roll necks	142
3.4 Rolling stock axles	143
3.5 Geared motor	144
3.6 Hydraulic motor	144

4. References

4.1 Rubber-material varieties and properties	146
4.2 SI units and conversion factors	148
4.3 Shaft tolerance	152
4.4 Housing bore tolerance	154
4.5 °C - °F temperature conversion table	156
4.6 Steel hardness conversion table	157
4.7 Viscosity conversion table	158
4.8 Shaft surface speed – Quick reference diagram –	159

5. Request Forms for Oil Seal Design and Production

160

Koyo Oil Seals: Features

1. Lightweight, compact, and energy-saving

Koyo oil seals offer high sealing performance, while being compact with reduced seal width. They help reduction of machine weight, size, and resource consumption

2. High sealing performance by optimum lip design

Koyo oil seals employ a linear-contact lip, which provides proper radial lip load. The lip design ensures excellent sealing performance, low torque, proper flexibility and high allowability for eccentricity.

3. Low heat generation and long service life by highly self-lubricating rubber materials

Based on extensive research and experimentation, JTEKT has succeeded in developing seal rubber materials with high self-lubrication performance. These rubber materials show limited chemical changes such as hardening, softening and/or aging.

These materials, having excellent durability, can offer long service life with less heat generated even under high-peripheral speed.

4. High sealing performance and long service life by hydrodynamic ribs (Perfect Seal, Helix Seal, Super Helix Seal)

The sealing lip has special spiral threads (hydrodynamic ribs) in one or two directions, which drastically improved sealing performance and service life.



Various oil seals



Large-size oil seals

■ Koyo O-Rings: Features

1. High sealing performance and reliability

High sealing performance against water, oil, air, various gases and chemicals.

2. Available in a full lineup of designs and sizes

3. Easy handling

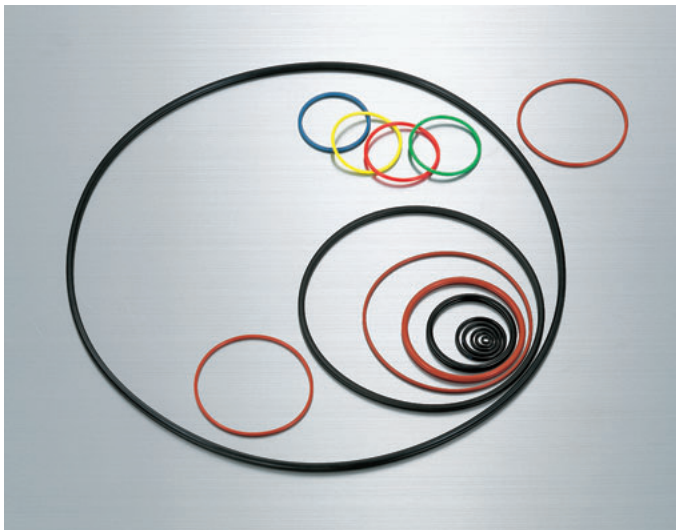

■ Various O-rings

Koyo Functional Products: Features

JTEKT produces various functional products based on advanced sealing technologies and sophisticated manufacturing expertise acquired through extensive research and development.

Koyo functional products are very helpful in improving

machine performance, reducing weight, size, noise and vibration.

Consult JTEKT if there is no product in this catalog that exactly matches your requirements--JTEKT can custom-design products.

1. Functional products for automobiles and forklift trucks



- Center bearing units
- Bearings molded with vibration isolating rubber
- Spark-plug tube gaskets
- Plastic gear shafts
- Pulley units

■ Various functional products



■ Bonded piston seals for automatic transmissions



■ Friction dampers for manual transmissions



■ Various boots for joints and dust covers

2. Functional products for motorcycles



■ Various functional products

- Air cleaner joints
- Carburetor joints
- Sprocket wheels
- Muffler joints
- Plastic gear shafts
- Oil strainers
- Mesh gaskets
- Ball-component clutch releases
- Vertical gaskets

FEM (Finite Element Method) Analysis

JTEKT uses the non-linear finite element method to analyze non-linear materials such as rubber, for which accurate analysis was difficult before. The company has been studying sealing-mechanism theories by this method in order to develop new products.

The findings so far have been very useful for basic research as well as for rubber-component design. The FEM is our common design tool today, enabling highly reliable analysis and evaluation, speeding up research and product development.

Pressure deflection, stress analysis

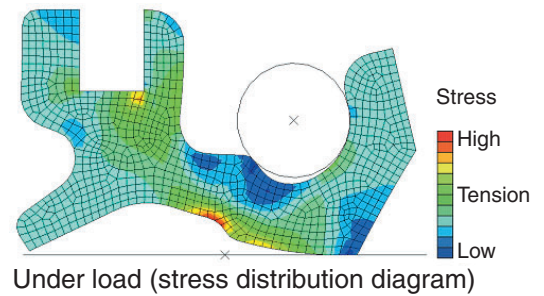
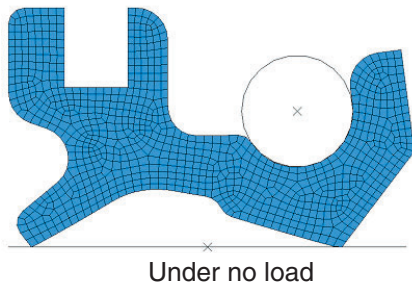

Metal ring three-dimensional stress analysis

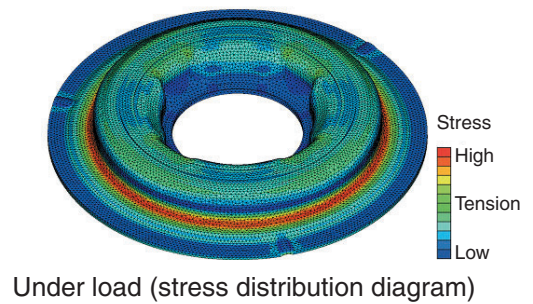

Heat transfer analysis (temperature distribution)

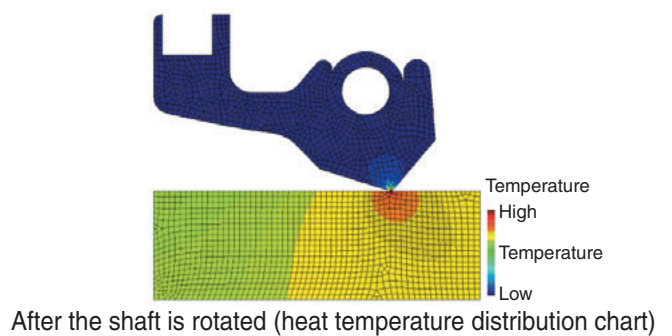
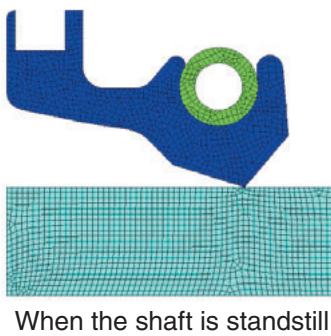

Three-dimensional seal lip vibration analysis

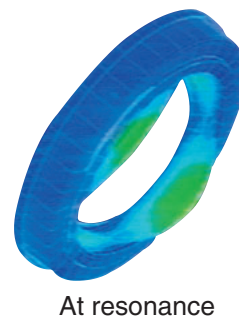

1

Oil Seals

1.1 Nomenclature and functions of seal components	8
(1) Nomenclature of components	8
(2) Component functions	8
1.2 Seal numbering system	10
1.3 Seal types	11
(1) Common seal types and their features	11
(2) Special seal types and their features	12
1.4 Selection of seal	15
(1) Selection of seal type	15
(2) Selection of rubber material	16
(3) Selection of metal case and spring materials	18
1.5 Shaft and housing design	18
(1) Shaft design	18
(2) Housing design	19
(3) Total eccentricity	21
(4) Allowable total eccentricity	21
1.6 Seal characteristics	22
(1) Seal service life	22
(2) Lip temperature	22
(3) Allowable shaft surface speed	23
(4) Allowable internal pressure	24
(5) Seal torque	24
1.7 Handling of seal	26
(1) Storage	26
(2) Handling	26
(3) Mounting	26
(4) Mounting of split MS-type seals	29
(5) Cautions after mounting	29
1.8 Causes of seal failures and countermeasures	30
(1) Causes of seal failures	30
(2) Causes of seal failures and countermeasures	31
1.9 Seal dimensional tables (Contents)	35

1.1 Nomenclature and functions of seal components

(1) Nomenclature of components

Oil seals work to prevent leakage of sealed objects such as lubricants from inside and also to prevent the entry of dust and contaminants from outside.

Oil seals are designed in a variety of shapes

according to the applications and substances to be sealed.

Fig. 1.1.1 shows a typical shape of seal and its component nomenclature.

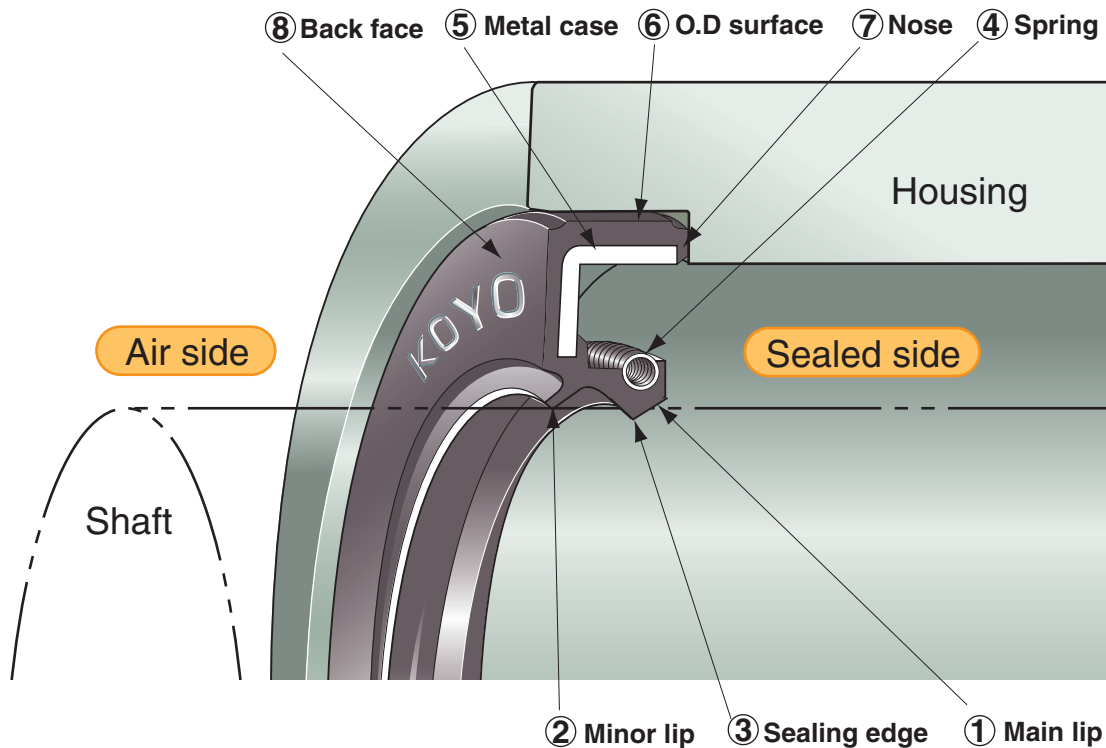

Fig. 1.1.1 Typically shaped oil seal and component nomenclature

(2) Component functions

① Main lip

The main lip is the most critical component of seals. Its sealing edge contacts around the shaft surface in order to provide excellent sealing performance.

During service, seals are placed under various stresses, such as machine vibration, shaft runout, and changes in the temperature and pressure of substances to be sealed.

The main lip is designed so as to generate force (radial lip load) and to keep the sealing edge consistently in contact with the shaft under such stresses.

For such stresses, seal rubber material is made from synthetic rubber, which is highly elastic and abrasion-resistant.

② Minor lip

The minor lip prevents the entry of dust and contaminants from outside. As a lubricant, grease can be retained in the space between main lip and minor lip.

③ Sealing edge

Section of the sealing edge is wedge-shaped to be pressed against the shaft surface and linearly contacts with the shaft to ensure sufficient sealing performance and suitability for operation at high peripheral speed.

④ Spring

The spring supplements the tension at the sealing edge to ensure tight contact between the shaft and the sealing edge and enhanced sealing performance. The spring also prevents the deterioration of main lip sealing performance caused by high heat or others.

Because this spring is a closely wound type coil, the initial tension can be obtained high level, and then changes in load characteristics can be gradual with respect to spring elongation. Tension at the sealing edge can thus be kept stable at an appropriate level.

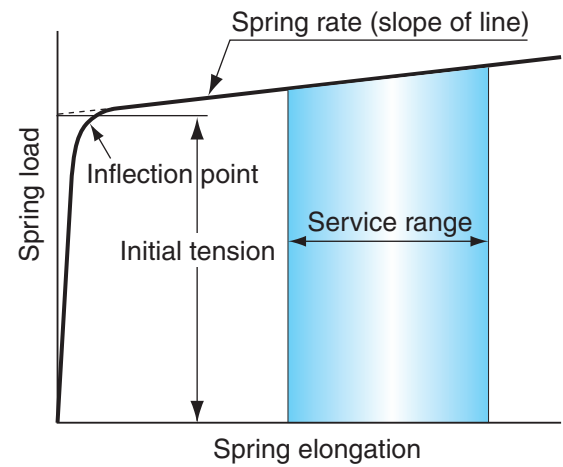

Fig. 1.1.2 Spring properties for seal

⑤ Metal case

The metal case provides rigidity on seal, helping it settle on the housing securely. It also ensures easy seal handling and mounting.

⑥ O.D surface

Seals are fitted tightly into the housing bore generally. O.D surface prevents the oil leakage through fitting area, while excluding contaminants. This surface may be made of either metal or rubber and selected depending on the application.

⑦ Nose

The front end face of the seal is called the nose. Seals are usually mounted for the nose to face the substances to be sealed. The nose is made of rubber and forms a gasket seal when compressed on housing shoulder.

⑧ Back face

The oil seal surface vertical to the center line of the shaft on the side that does not come in contact with substances to be sealed is generally called the back face. Either metal or rubber peripheral surface is available, depending on the application.

1.2 Seal numbering system

Table 1.2.1 Seal numbering system

Example

MH S A 45 70 8 J

Special shape code J: Additional code is added here as an identifier when two or more seals have exactly the same type codes and dimensional numbers.

Dimensional numbers [Shaft number 45: The seal suits the shaft diameter of $\phi 45$ mm.
Housing bore number ... 70: The seal suits the housing bore diameter of $\phi 70$ mm.
Width number 8: The seal width is 8 mm.

Lip type code No code: without minor lip
A: with minor lip

Spring code No code: without spring
S: with spring

Seal type code [MH: O.D wall is rubber material
HM: O.D wall is metal case
HM(S)H: O.D wall is metal with a reinforcing inner metal case.
(A spring is always provided for this type.)

Remark) For the type codes of special type seals, refer to Section 1.3.

Koyo oil seals: Features

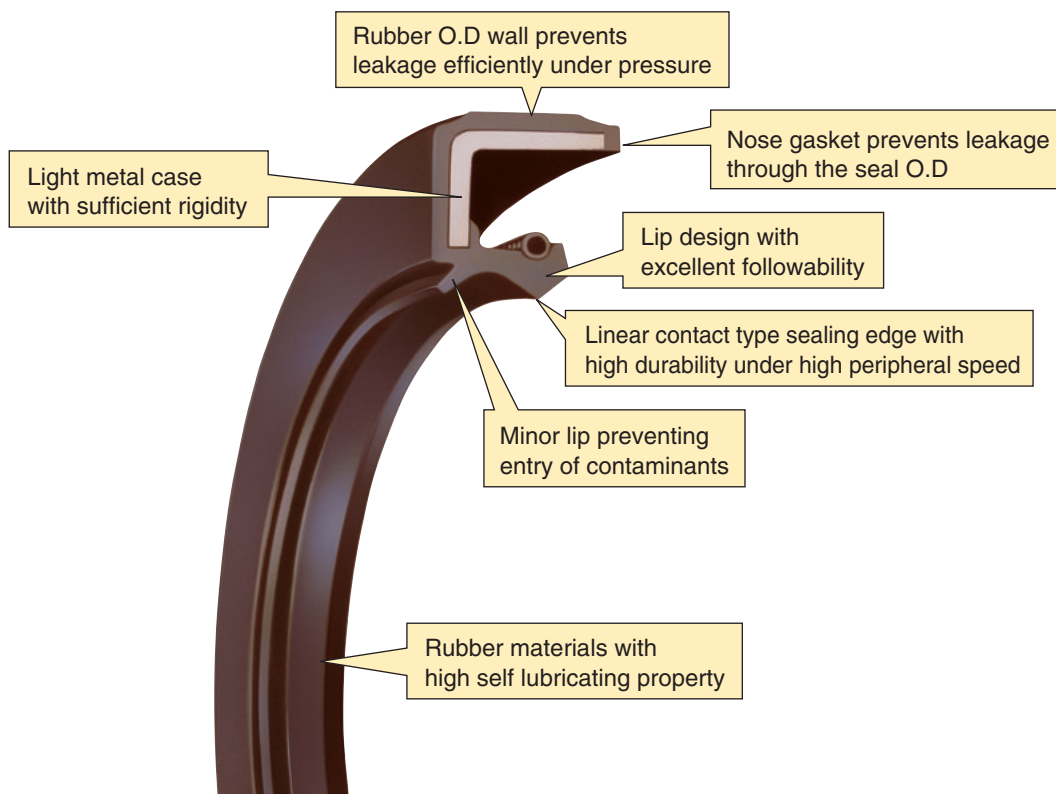

1.3 Seal types

(1) Common seal types and their features

Seals are classified by O.D wall material, lip type and whether with spring or without spring. Major oil seals are specified in ISO 6194, JIS B 2402, and JASO F 401. Table 1.3.1 shows common seal types.

Table 1.3.2 lists the seal type codes used at JTEKT, along with the corresponding codes used in the ISO, JIS, and JASO standards.

Table 1.3.1 Oil seals of common types

	With spring ¹⁾			Without spring	
	Rubber O.D wall ²⁾	Metal O.D wall ³⁾	Metal O.D wall (with a reinforcing inner metal case) ^{3) 4)}	Rubber O.D wall ²⁾	Metal O.D wall ³⁾
Without minor lip					
Type code	MHS	HMS	HMSH	MH	HM
With minor lip ⁵⁾					
Type code	MHSA	HMSA	HMSAH	MHA	HMA
Features of each type	1) With spring type secures stable sealing performance 2) Rubber O.D wall type provides stable sealing performance around the seal O.D surface 3) Metal O.D wall type ensures improved fitting retention between the seal O.D and the housing bore 4) Reinforcing inner metal case in the metal O.D wall type protects the main lip 5) With minor lip type is applied for the application where there are many contaminants at the air side (back face side)				

Table 1.3.2 Koyo oil seal type codes corresponding to the codes used in Industrial standards

KOYO	ISO ¹⁾ · JIS ²⁾	Old JIS	JASO ³⁾
MHS	Type 1	S	S
HMS	Type 2	SM	SM
HMSH	Type 3	SA	SA
MH	—	G	G
HM	—	GM	GM
MHSA	Type 4	D	D
HMSA	Type 5	DM	DM
HMSAH	Type 6	DA	DA
MHA	—	—	P
HMA	—	—	PM

Notes 1) ISO : International Organization Standardization
 2) JIS : Japanese Industrial Standard
 3) JASO : Japanese Automobile Standard Organization

(2) Special seal types and their features

JTEKT and Koyo sealing techno Co.,Ltd. provide special seals to meet a wide variety of machines and applications:

Table 1.3.3 Oil seals of special types (1)

⊙: For bi-directional rotation ○: For uni-directional rotation

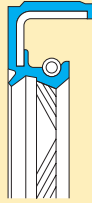
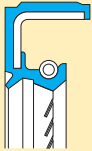
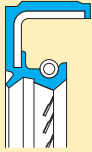
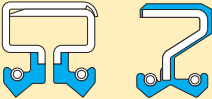
Seal type	Type code and shape	Motion	Features	Applications
Perfect Seals	 MHSA...XBT	⊙	The hydrodynamic ribs provided in two directions on the lip ensure improved pumping effect and higher sealing performance in both rotational directions of the shaft.	Reduction gears input shafts Differential gear sides
Helix Seals	 MHSA...XRT MHSA...XLT	○	The hydrodynamic ribs provided in a direction on the lip ensure improved pumping effect and higher sealing performance even under high peripheral speed and eccentricity.	Engine crankshafts Oil pumps Differential gear sides Reduction gears input shafts
Super Helix Seals	 MHSA...XRT MHSA...XLT	○	Optimized hydrodynamic ribs provided in a direction ensure long-lasting high pumping effect.	Engine crankshafts Oil pumps Differential gear sides Reduction gears input shafts
Double Lip Seals	 HMSD MHSD	⊙	These seals can separate and seal two kinds of oil or fluid on one shaft	Engaged positions of transfer system



■ Perfect Seal









■ Helix Seal

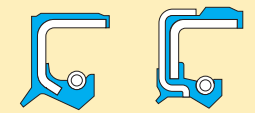

■ Super Helix Seal

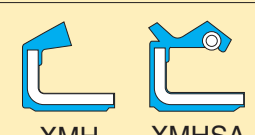
Table 1.3.3 Oil seals of special types (2)

⊙: For bi-directional rotation –: For reciprocation

Seal type	Type code and shape	Motion	Features	Applications
Pressure-resistant Seals	 MHP...P GMHP...P	⊙	These seals are designed to reduce lip deformation caused by oil pressure. Sealing performance does not being deteriorated under high pressure	Hydraulic motors Motorcycle engine crankshafts Power steering input shaft
Reciprocating Seals	 MHR...R	⊙ –	These seals are designed to accommodate shaft strokes and to lessen lip deformation caused by shaft reciprocating motion	CVT shafts of motorcycles
External Lip Seals	 XM XMHP	⊙	This type of seal has the lip on its outside, sealing the contact with housing	Front hubs Rear hubs
Seals with Side Lip	 MHP...S	⊙	A large side lip ensures prevention of entry of dust/water	Differential gear sides Differential pinion gear
Mud-resistant Seals with Integrated Sleeve	 M	⊙	These seals are designed to enhance prevention of entry of mud	Wheel hubs
HR Seals	 HR	⊙	HR seals ensures sealing performance around seal O.D and retain fitting with housing	Engine crankshafts Wheel hubs
SIM Seals	 MHR MHRP	⊙	The seals are spring-in mold type, which protect the spring from dust / water and enhance durability	Plug tubes Wheel hubs



■ Seal with Side Lip







■ HR Seal

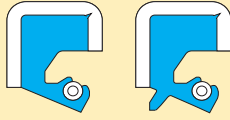
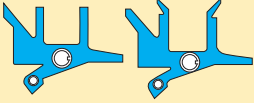

■ SIM Seal

Table 1.3.3 Oil seals of special types (3)

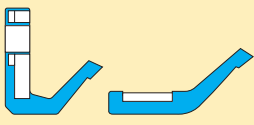
⊙: For bi-directional rotation

Seal type	Type code and shape	Motion	Features	Applications
Full Rubber Seals	 MS	⊙	Mounting is easy because of full rubber construction. Split type seals are available which can be mounted directly, not necessarily mounting from the shaft end	Long shafts, complex shaped shaft
YS Type Seal	 YS YSA	⊙	Wide range sizes for medium and large shafts are available	Rolling mills Various medium and large size machines
MORGOIL Seals	 MS...J MS...NJ	⊙	MORGOIL seals are used exclusively on MORGOIL bearings	MORGOIL bearings
Water Seals	 XMHE	⊙	The double lips ensure improved water-proof performance	Rolling mill roll necks
Scale Seals	 WR WR...BJ	⊙	These seals prevent the ingress of scales in rolling oil	Rolling mill roll necks
V-Rings	 MV...A	⊙	With these rings, shafts can be sealed at the end. The V-rings can be mounted easily in limited spaces	Rolling mill roll necks

1.4 Selection of seal

(1) Selection of seal type

To select a seal type, seal O.D wall material, lip type, and whether a spring should be provided or not should be decided based on operational conditions as shown in flowcharts below.

If you need oil seals used under special conditions not covered in the flowcharts, refer to Section 1.3 Paragraph (2), "Special seal types and their features."

Table 1.4.1 Flowcharts for oil seal selection

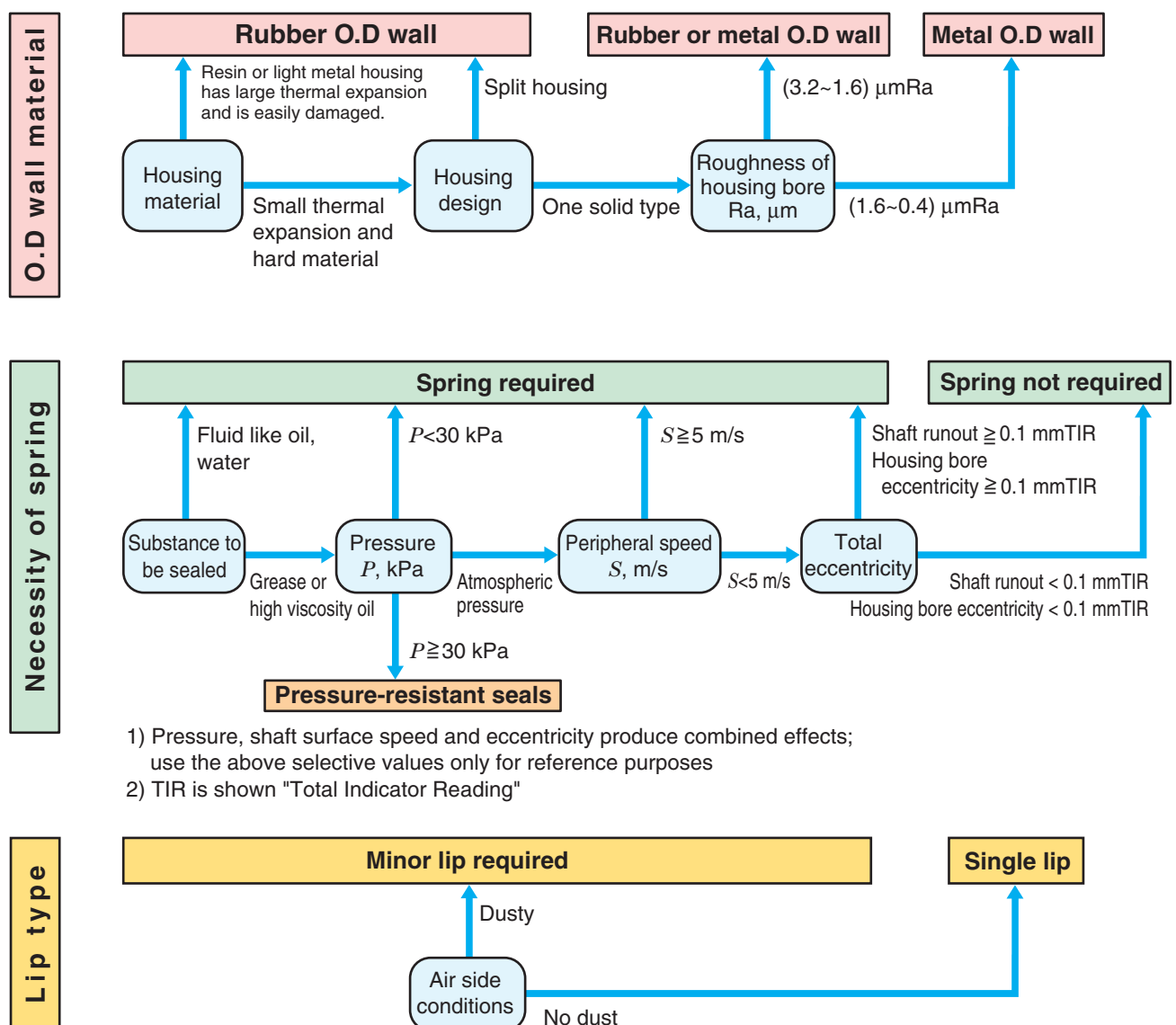

★Seal selection example

- Housing: Made of steel, one solid design, housing bore surface roughness 1.8 μmRa
- Substance to be sealed: Grease
- Pressure: Atmospheric
- Shaft surface speed: 6 m/s
- Air side condition: Dusty

According to the above flowcharts, a seal with a rubber or metal O.D wall, spring, and minor lip is the most suitable for these conditions. The MHSA or HMSA seal is recommended in this case.

(2) Selection of rubber material

Rubber materials should be selected according to temperature conditions and substances to be sealed.

Table 1.4.2 lists rubber materials along with their operational temperature ranges and their stability to fluids.

- ⊙ : The rubber has excellent resistance to the substance to be sealed
- : The rubber has good resistance to the substance except under extreme conditions
- △ : The rubber is not resistant to the substance except under specific favorable conditions
- × : The rubber is not resistant to the substance

Table 1.4.2 Rubber materials, operational temperature ranges and their stability to fluids⁴⁾

Rubber material (ASTM ³⁾ code)	Grade	Features	Operational temperature range ¹⁾²⁾ Lower limit Upper limit Normal operation range -50 0 50 100 150 200 °C	Fuel oil			Lubrication oil and hydraulic fluid						Grease			Chemicals and water										
				Gasoline (regular)	Gasoline (premium)	Kerosene, light oil	Gear oil	Turbine oil	Engine oil	Automatic-transmission fluid	Mineral oil	Water + glycol	Phosphoric ester	Brake oil	Lithium base	Urea base	Ester base	Silicone base	Alcohol	Ether	Ketone	Water	Concentrate inorganic acid solution	Dilute inorganic acid solution	Concentrate alkaline solution	Dilute alkaline solution
Nitrile rubber (NBR)	Standard type	Well-balanced rubber in resistance to high-, low- temperature, and to abrasion	-30 100	○	△	⊙				⊙	△				△											
	Low-temperature resistant type	High resistant to both high- and low-temperatures and to abrasion	-40 100	△	△	○				○	△				△											
	High- and low-temperature resistant type	Very strong and low strain. Superior in resistance to high- and low-temperature	-40 110	△	△	○	⊙	⊙	⊙	○	⊙	○	×	×	⊙	⊙	△	⊙	○	△	×	⊙	△	○	○	○
	Heat resistant type	Enhanced heat and abrasion resistance. Highly compatible with synthetic oil	-20 120	○	○	⊙				⊙	○				○											
	For food processing machines	Nitrile rubber passed tests specified in the Food Sanitation Law	-30 100	△	△	○				○	△				△											
Hydrogenated nitrile rubber (HNBR)	Standard type	Compared with nitrile rubber, superior in resistance to heat and to abrasion	-30 140	○	○	⊙	⊙	⊙	⊙	⊙	⊙	○	×	×	⊙	⊙	△	⊙	○	△	×	⊙	△	○	○	○
Acrylic rubber (ACM)	Standard type	High resistant to oil and to abrasion	-20 150																							
	High- and low-temperature resistant type	Improved low-temperature resistance. Low strain and same level heat resistance as standard type	-30 150	○	△	⊙	⊙	⊙	⊙	⊙	⊙	×	×	×	⊙	⊙	×	⊙	×	×	×	×	×	×	△	×
Silicone rubber (VMQ)	Standard type	Wide operational temperature range and good abrasion resistance	-50 170	×	×	○	×	○	○	△	⊙	△	○	△	○	○	○	×	○	×	○	○	△	○	⊙	⊙
Fluorocarbon rubber (FKM)	Standard type	Most superior in heat resistance and good abrasion resistance	-20 180	⊙	⊙	⊙	⊙	⊙	⊙	⊙	⊙	△	×	△	⊙	△	⊙	○	×	×	△	○	⊙	×	△	

Notes 1) Operational temperature means the lip (Sliding part) temperature. It should be determined based on ambient temperature, heat generated by the machine, lip friction heat, heat generation by the agitation of the substance to be sealed and heat transferred from other components etc.
 2) The highest normal-operation temperature may be lower than indicated in this table, depending on the kind and properties of the substance to be sealed (Refer to Table 1.4.3.)
 3) ASTM : American Society for Testing and Materials.
 4) Properties above may be affected by the components of rust preventing oil and cleaning fluid. Consult with JTEKT.

Table 1.4.3 Upper limits guideline of normal operation temperature of rubber materials used with different oils (°C)

Rubber material	Gear oil	Turbine oil	Engine oil	ATF
Nitrile rubber	(100)	100	120	(120)
Hydrogenated nitrile rubber	140	←	←	←
Acrylic rubber	150	←	←	←
Silicone rubber	Incompatible	150	170	(150)
Fluorocarbon rubber	180	←	←	←

Remark)
 The () indicates oil with extreme pressure additives. Extreme pressure additives are compounds of phosphor, sulfur or chlorine base, added to prevent wear or seizure on sliding or rotating surfaces. These compounds are activated by heat and chemically react against rubber, which deteriorates rubber properties.

Small talk 1

A new salesman's surprise

One day a new staff who only recently joined the sales department received a complaint from a customer. "Your oil seal is leaking . . . it breaks into pieces!"

He checked the actual seal at the customer's site and found it was clayish and broke into pieces when he touched it. The customer was very upset and said, "We chose your expensive silicone seal because it was supposed to be resistant to high

temperature." The salesman confused and then consulted his manager. "This phenomenon is called cure reversion; gear oil shredded the silicone rubber molecules," the manager answered and advised, "Silicone rubber must not be used in gear oil application." Telling this explanation to the customer, the new salesman realized the importance of rubber-oil compatibility through this experience.

(3) Selection of metal case and spring materials

The materials of metal case and spring can be selected according to the substance to be sealed.

Table 1.4.4 Compatibility of metal-case and spring materials with substance to be sealed

Material Substance to be sealed	Metal case		Spring	
	Cold rolled carbon steel sheet (JIS SPCC)	Stainless steel sheet (JIS SUS304)	High carbon steel wire (JIS SWB)	Stainless steel wire (JIS SUS304)
Oil	○	–	○	–
Grease	○	–	○	–
Water	×	○	×	○
Seawater	×	○	×	○
Water vapor	×	○	×	○
Chemicals	×	○	×	○
Organic solvent	○	○	○	○

○ : Compatible × : Incompatible – : Not applicable

Small talk 2

A service engineer's finding

One customer called, "Some seals show oil leakage and some are OK. Please come and see immediately." A JTEKT service engineer visited the customer.

He checked shaft diameter and any damage, also visually checked the seals, but no possible cause of oil leakage was found.

He asked how the shaft surface was finished. It was paper lapped to get the desired level of surface roughness. He then checked the shaft surface and found that the leaking shaft had lead marks (spiral traces of lapping) running in the leaking direction. When he rotated the shaft in the reversing direction, no leakage occurred.

Showing a catalog, he advised the customer to finish shafts by plange cut grinding. Satisfied, he went back and felt it was a good day.

1.5 Shaft and housing design

(1) Shaft design

Oil seals can show good sealing performance when mounted on properly designed shafts. To design shafts properly, follow the specifications below.

1) Material

Shafts should be made from carbon steels for machine structural use, low-alloy steel, or stainless steel. Brass, bronze, aluminum, zinc, magnesium alloy and other soft materials are not suitable, except for special applications such as for low-speed or in a clean-environment.

2) Hardness

Shaft hardness should be at least 30 HRC. In a clean environment, shaft hardness does not influence seal performance. However, in an environment where dust or contaminated oil exists, harder shaft is desired.

Hard shaft is advantageous regarding seal damage prevention.

3) Dimensional accuracy

The shaft diameter tolerance should be h8. Seals are designed to suit shafts with the tolerance of h8.

When mounted on other tolerance shafts, seals may be unable to provide sufficient sealing performance. For use of other tolerance shafts, consult JTEKT.

Table 1.5.1 h8 Shaft tolerance

Nominal shaft diameter <i>d</i> , mm		Tolerance μm	
		h8	
Over	Up to	Upper	Lower
3	6	0	-18
6	10	0	-22
10	18	0	-27
18	30	0	-33
30	50	0	-39
50	80	0	-46
80	120	0	-54
120	180	0	-63
180	250	0	-72
250	315	0	-81
315	400	0	-89
400	500	0	-97
500	630	0	-110
630	800	0	-125
800	1 000	0	-140

4) Shaft end chamfer

To protect seals from damage at mounting onto shafts, recommended chamfer on the shaft end is shown below.

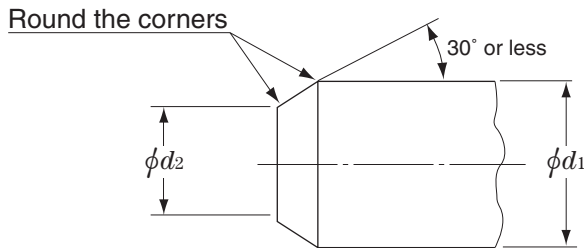

Nominal shaft diameter d_1 , mm		d_1-d_2 mm	Nominal shaft diameter d_1 , mm		d_1-d_2 mm
Over	Up to		Over	Up to	
–	10	1.5 min.	50	70	4.0 min.
10	20	2.0 min.	70	95	4.5 min.
20	30	2.5 min.	95	130	5.5 min.
30	40	3.0 min.	130	240	7.0 min.
40	50	3.5 min.	240	500	11.0 min.

Note) When round chamfer is applied, take the above specified d_1-d_2 dimensional chamfer or more.

Fig. 1.5.1 Shaft end chamfer

5) Surface roughness and finishing method

To ensure the sealing performance of seals, the shaft surface to be in contact with the lip should be finished to $(0.63-0.2) \mu\text{mRa}$ and $(2.5-0.8) \mu\text{mRz}$ in roughness.

Note that lead marks on the shaft surface may carry the substance to be sealed in the axial direction during shaft rotation, which interferes with the function of the seal. Finish shaft surface such that the lead angle will be no greater than 0.05° . To achieve this, plange cut grinding is most suitable. To avoid undulation on the shaft surface, the ratio of shaft rotational speed vs grinding-wheel rotational speed should not be an integer.



■ Good finished surface

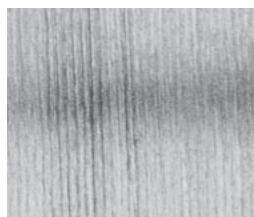

■ Undesirable finished surface

The surface shows visible lead marks

Fig. 1.5.2 Shaft surface with and without lead marks

(2) Housing design

1) Material

Steel or cast iron is generally used as the material of housings. When aluminum or plastic housing is used, the following consideration and study are required, as seal seating in housing bore may become loose fitting under high temperature because the housing material and seal material have different linear expansion coefficients. This may cause problems such as leakage through the seal O.D, or seal dislocation.

2) Dimensional accuracy

The housing bore tolerance should be H7 or H8 when bore is 400 mm or less. For larger housing bores, recommended tolerance is H7.

Table 1.5.2 Housing bore tolerance

Nominal bore diameter D , mm		Tolerance μm			
		H7		H8	
Over	Up to	Upper	Lower	Upper	Lower
3	6	+12	0	+18	0
6	10	+15	0	+22	0
10	18	+18	0	+27	0
18	30	+21	0	+33	0
30	50	+25	0	+39	0
50	80	+30	0	+46	0
80	120	+35	0	+54	0
120	180	+40	0	+63	0
180	250	+46	0	+72	0
250	315	+52	0	+81	0
315	400	+57	0	+89	0
400	500	+63	0	–	–
500	630	+70	0	–	–
630	800	+80	0	–	–
800	1 000	+90	0	–	–
1 000	1 250	+105	0	–	–
1 250	1 600	+125	0	–	–

1.5 Shaft and housing design

3) Chamfer

Provide the chamfer at the housing bore inlet as shown below so that a seal can be mounted easily and avoided from damages.

Shouldered bore

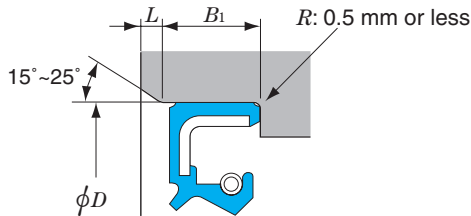

Straight bore

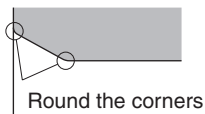
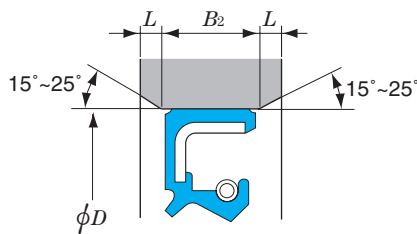

Unit : mm

Nominal seal width, b		B_1 min.	B_2 min.	L
Over	Up to			
–	10	$b + 0.5$	$b + 1.0$	1.0
10	18			
18	50	$b + 0.8$	$b + 1.6$	1.5

[Remark] b indicates the width of a seal.

Fig. 1.5.3 Recommended housing bore chamfers

4) Housing shoulder diameter

In case the housing bore has a shoulder, satisfy the following dimensional requirements.

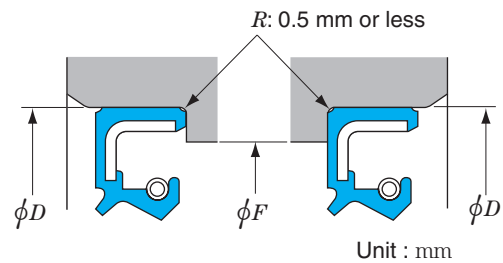

Nominal seal O.D, D		F
Over	Up to	
–	50	$D - 4$
50	150	$D - 6$
150	400	$D - 8$

[Remark] D indicates the outer diameter of a seal.

Fig. 1.5.4 Recommended housing shoulder diameters

5) Surface roughness

To ensure seal sitting and to prevent leakage through seal O.D, finish bore surface to the roughness specified below.

Table 1.5.3 Housing bore surface roughness

Seal type	Housing bore surface roughness
For metal O.D wall type seal	(1.6~0.4) μmRa (6.3~1.6) μmRz
For rubber O.D wall type seal	(3.2~1.6) μmRa (12.5~6.3) μmRz

Seals with coated metal O.D wall are available in case metal O.D wall type seals with extremely high sealing performance are required.

Consult JTEKT for these oil seals.

(3) Total eccentricity

When the total eccentricity is excessive, the sealing edge of the seal lip cannot accommodate shaft motions and leakage may occur.

Total eccentricity is the sum of shaft runout and the housing-bore eccentricity. It is normally expressed in TIR (Total Indicator Reading).

Shaft runout is defined as being twice the eccentricity between the shaft center and center of shaft-center rotation trajectory.

This is also normally expressed in TIR.

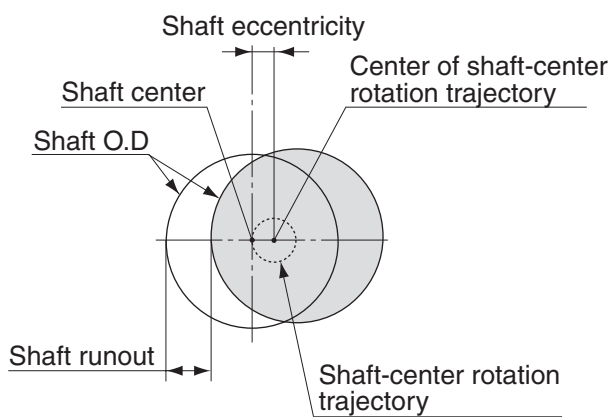

Fig. 1.5.5 Shaft runout

Housing bore eccentricity is defined as being the double of eccentricity between the housing-bore center and shaft rotation center. It is generally expressed in TIR (Total Indicator Reading).

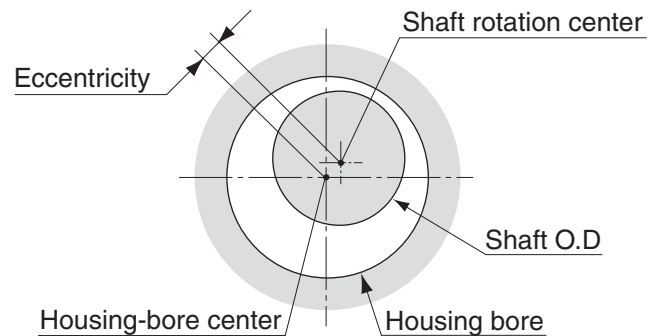

Fig. 1.5.6 Housing bore eccentricity

(4) Allowable total eccentricity

The allowable total eccentricity is the maximum total eccentricity at which the sealing edge can accommodate shaft rotation and retain adequate sealing performance. The allowable total eccentricity of seals is dependent not only on seal characteristics, such as seal type, seal size, and rubber material, but also on other conditions, including shaft diameter tolerance, temperature and rotational speed.

It is therefore difficult to determine the allowable total eccentricity of individual seals. The typical allowable total eccentricity values of seals are shown in Fig. 1.5.7.

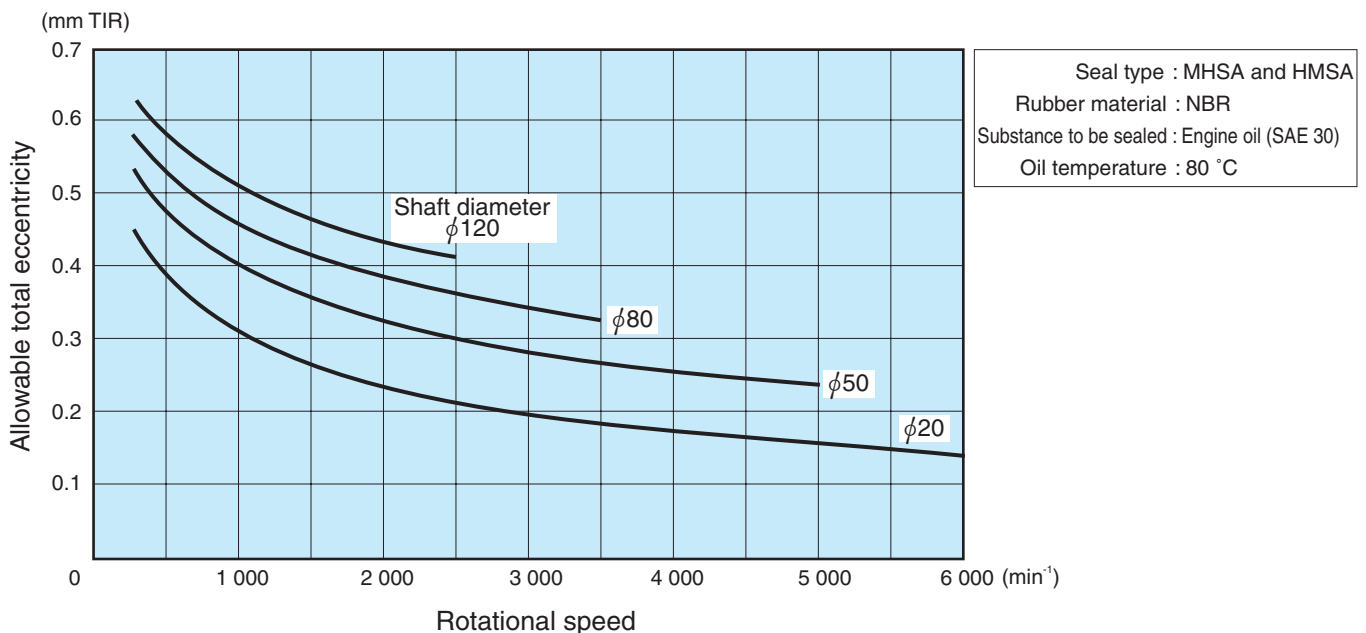

Fig. 1.5.7 Allowable total eccentricity for oil seal

1.6 Seal characteristics

(1) Seal service life

The seal service life is defined at the time reached to insufficient seal performance, by the lip rubber abraded, chemically deteriorated or hardened.

It is not so easy to determine actual seal service life, because it is dependent on many factors, such as condition of operational temperature, eccentricity, rotational speed, substance to be sealed, and

lubrication.

The diagram below (Fig. 1.6.1) shows the curves of estimated seal service life, obtained using major life-determining conditions as parameters, such as rubber material, lubricant, and lip temperature. Approximate seal life can be determined from this diagram.

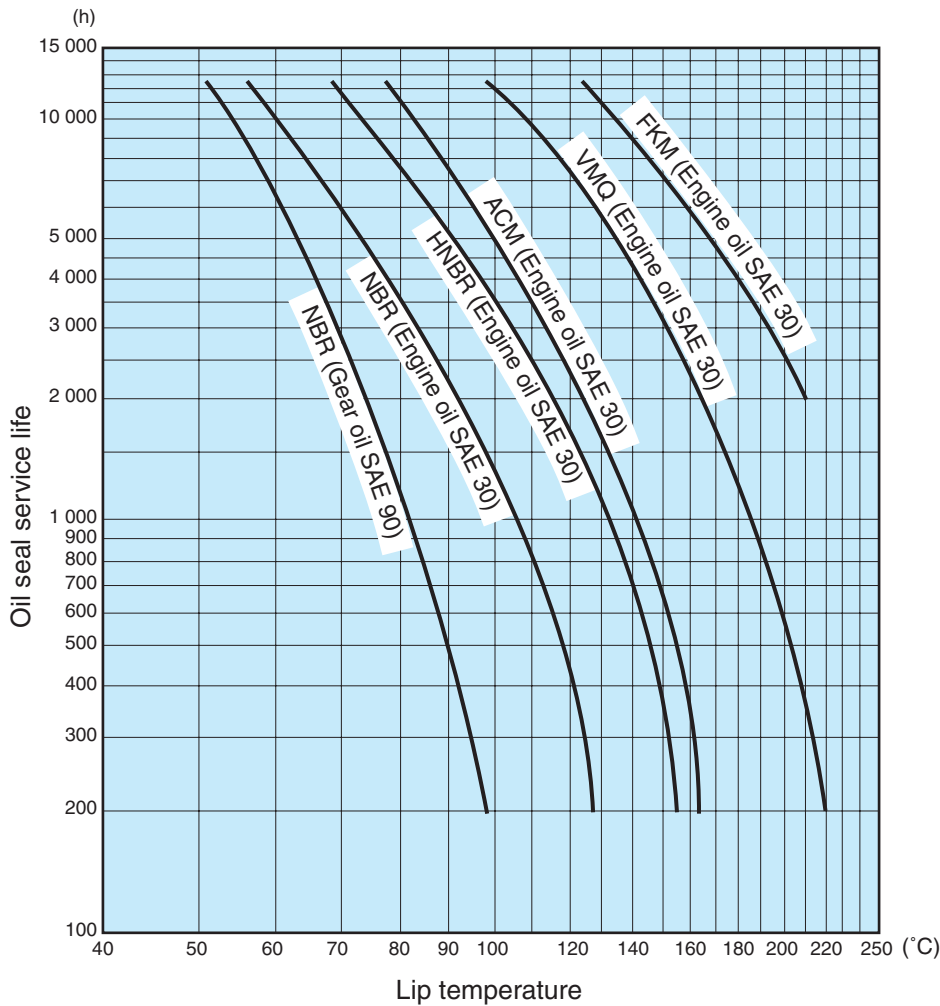

Fig. 1.6.1 Oil seal service life estimation curves

(2) Lip temperature

To determine the seal service life based on the above diagram, it is critical to estimate lip temperature precisely.

As the shaft rotates, the seal lip is heated due to friction. Lip temperature is dependent on the balance between the energy supplied by frictional heat and the radiated energy, which varies according to temperature

difference and the construction surrounding the seal.

Many factors influence lip temperature, so it is difficult to determine this precisely.

The following is the procedure for estimation of lip temperature.

● Lip temperature estimation method

- ① Calculate the peripheral speed at the sealing edge using the following equation

$$v = \frac{\pi d n}{(60 \times 1\,000)}$$

where,

- v : peripheral speed at the sealing edge, m/s
- π : Ratio of circle circumference to diameter (3.14)
- d : Shaft diameter, mm
- n : Rotational speed, min^{-1}

- ② Determine the supposed ambient temperature
- ③ Find the point at which the ambient temperature curve meets the calculated shaft surface speed in Fig. 1.6.2
- ④ Read the ordinate value of the point
- ⑤ Obtain the estimated lip temperature by the sum of the ordinate value and ambient temperature

Example

Shaft diameter: $\phi 50$ mm

Rotational speed: 4 000 min^{-1}

Ambient temperature: 80 °C

Peripheral speed at the sealing edge can be obtained as follows;

$$v = \frac{\pi \times 50 \times 4\,000}{60 \times 1\,000} = 10.5 \text{ m/s}$$

In Fig. 1.6.2, the cross of the curve for ambient temperature 80 °C and peripheral speed 10.5 m/s indicates that the lip temperature rise will be 20 °C.

Therefore, lip temperature is estimated 100 °C (80 + 20 = 100 °C).

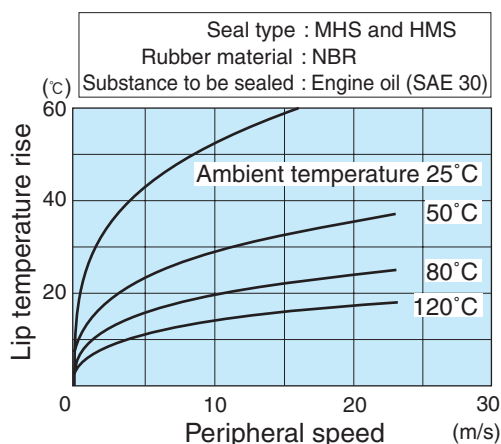

Fig. 1.6.2 Estimated lip temperature rise curves

(3) Allowable peripheral speed

The sealing edge of the seal should provide constant sealing performance, maintaining contact with the shaft while accommodating runout of the shaft (sum of shaft runout and mounting eccentricity).

When shaft rotation is extremely fast, the sealing edge eventually becomes unable to accommodate runout of the shaft (sum of shaft runout and housing-bore eccentricity), thus deteriorating sealing performance. The speed just before the sealing performance is deteriorated, is called the allowable peripheral speed for seals.

The allowable peripheral speed for seal is mostly influenced by shaft runout. When total eccentricity is small, the allowable peripheral speed is a constant value, depending on the rubber material and seal type.

The diagrams below show the typical allowable peripheral speed for seals mounted on the shaft and housing that are finished to a given level of accuracy.

Figs. 1.6.3 and 1.6.4 show the examples of allowable peripheral speed actually measured with the oil seals attached to the shaft finished with a certain accuracy and housing.

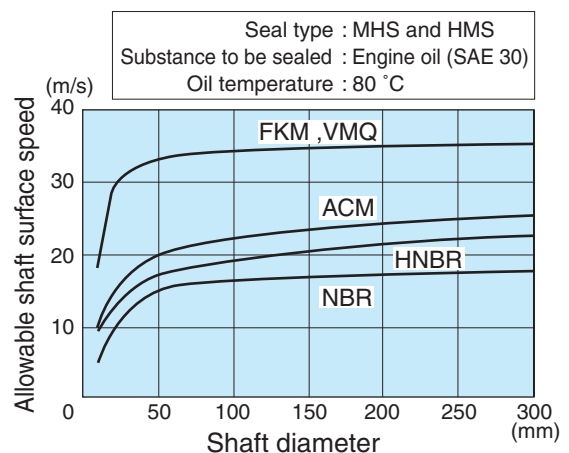

Fig. 1.6.3 Relation between rubber materials and allowable peripheral speed for seal

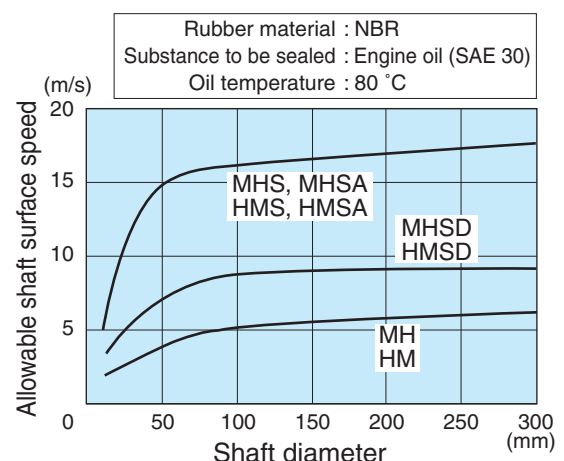

Fig. 1.6.4 Relation between seal types and allowable peripheral speed for seal

(4) Allowable internal pressure

Another factor that may deteriorate seal performance is internal pressure. The allowable internal pressure is also significantly dependent on runout of the shaft (sum of shaft runout and housing-bore eccentricity).

Fig. 1.6.5 shows the example of allowable internal pressure actually measured with the oil seals attached to the shaft finished with the accuracy recommended in this catalogue and housing.

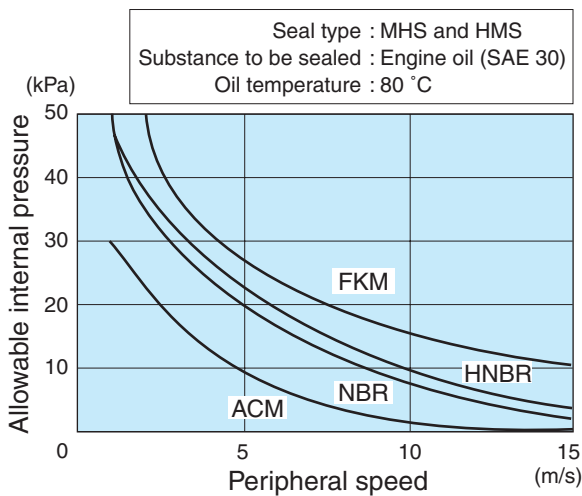

Fig. 1.6.5 Allowable internal pressure for seal

Small talk 3

A precious experience for a new salesman

"The oil seal melts down and oil leaks!"

Receiving an urgent phone call from a customer, a new salesman at JTEKT left the office immediately, believing that something critical had happened.

At the customer's site, the lip was abraded significantly and the rubber did look molten. The customer suspected that the material was the cause of the problem.

Browsing the catalog confusedly, he questioned the customer, remembering the sales-training lectures he had attended before. "How did you lubricate the seal before its initial use?"

Suspecting that insufficient initial lubrication might be the cause, he instructed the customer to coat grease around the lip and run the machine.

Two hours passed, and the seal still showed no leakage. An overhaul proved that the seal was in good condition, with negligible lip abrasion.

"I now thoroughly understand the importance of pre-lubrication," said the customer. It was a precious experience for the salesman as well.

(5) Seal torque

The seal torque is determined by lip radial load, coefficient of friction, and shaft diameter, and can be calculated by the following equation:

$$T = \frac{1}{2 \times 1000} \mu d R_L$$

where,

T : Seal torque, N · m

μ : Coefficient of friction at sealing edge (including oil viscosity)

d : Shaft diameter, mm

R_L : Lip radial load, N

Lip radial load is determined by three factors: a component of stress caused by circumferential lip elongation that occurs when the seal is mounted on a shaft, a component stress caused by deflection at the lip base, and a component of spring load (Fig. 1.6.6).

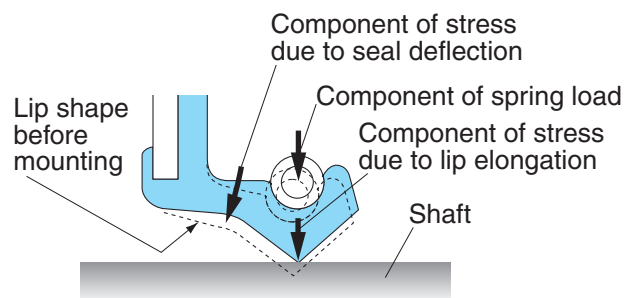

Fig. 1.6.6 Factors of lip radial load

The coefficient of friction at the sealing edge varies significantly depending on type of lubricants used and peripheral speed. To find rotational torques of oil seals, various operating conditions must be taken into consideration. For details, consult JTEKT.

1) Initial seal torque

Seal torque may be very high just after the seal mounting on a machine. However, it will become stable low torque within one or two hours (Fig. 1.6.7).

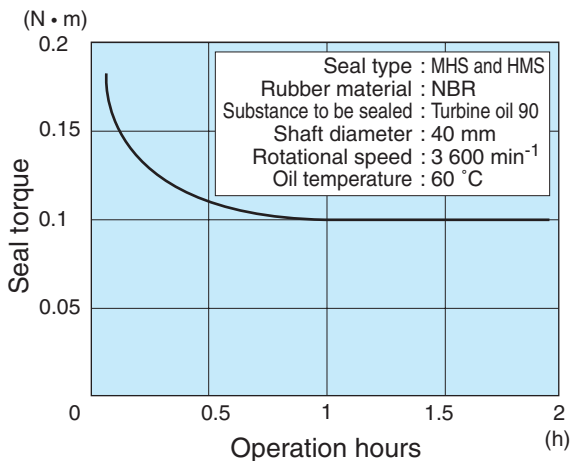

Fig. 1.6.7 Seal torque change with passing time

Initial high torque occurs because the coefficient of shaft-lip friction is unstable. As operation continues, the shaft and lip become running in each other, it stabilizes the friction coefficient and seal torque.

2) Factors for seal torque

Fig. 1.6.8 shows how rotational speed and lubricant influence seal torque. As this diagram shows, generally seal torque increases in proportion to shaft rotational speed increase. High viscosity lubricating oil also increases seal torque.

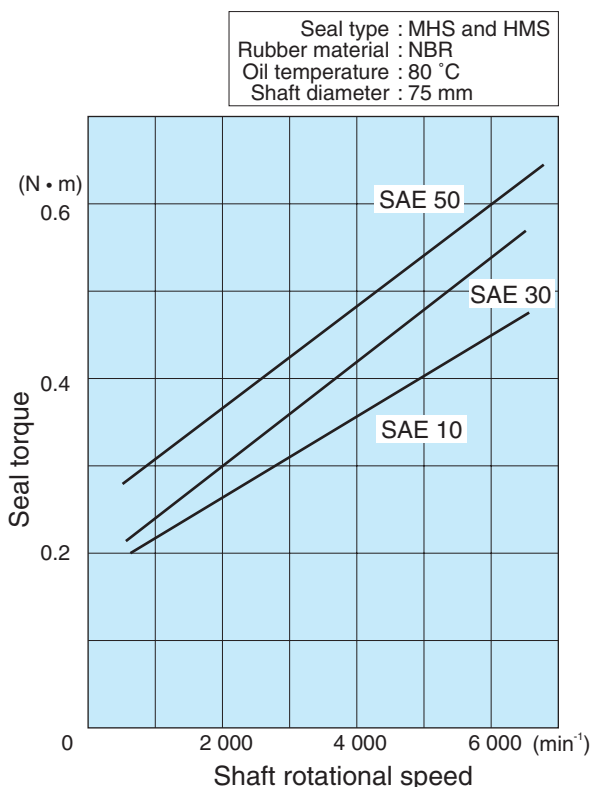

Fig. 1.6.8 Relation between rotational speed and seal torque

Fig. 1.6.9 shows how shaft diameter influences seal torque. The larger shaft diameter, the higher the seal torque correspondingly.

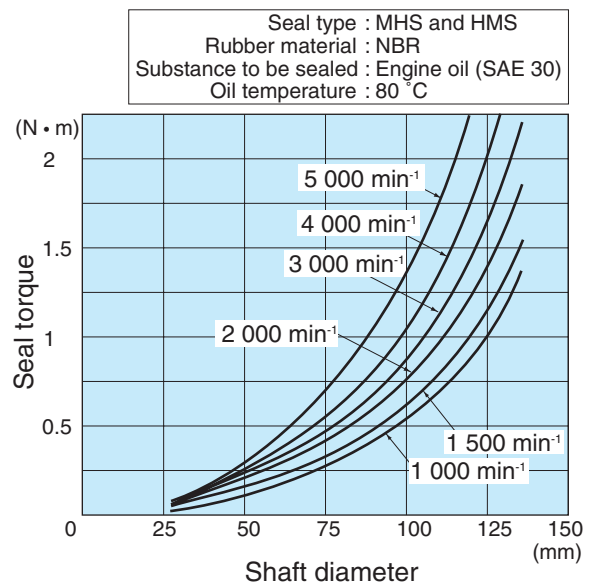

Fig. 1.6.9 Relation between shaft diameter and seal torque

Small talk 4

A discovery on a cold day

A second-year JTEKT sales rep received a harsh complaint from a customer. "Oil seals cannot be easily mounted today! When we press-fit them, the rubber tears."

He checked the seal at the customer's site, but could not find the reason. Then he consulted his manager by phone for advice.

"The seal is having a 'cold'," his manager responded. "Like humans, seals do not enjoy a cold environment. Tell them to warm up the room and try again." Following this advice, a stove was carried into the assembly shop and the seal was tried to remount after being slightly heated. To the surprise of the customer as well as the sales rep, the seal could be mounted smoothly without any problem.

The customer was very grateful to him. "Thank you for dealing with the problem. We also can now work in a warm environment." The sales rep returned to the office, feeling very proud of himself.

Back in the office, he heard another good piece of news from a material engineer: "Recent Koyo oil seals are made of improved material and can operate well in cold environments."

1.7 Handling of seal

Carelessness in seal handling may cause oil leakage. Correct action should be taken for good inwards, storage, transportation, handling and mounting.

(1) Storage

Follow the instructions below in the storing.

- Keep air-condition: Room temperature Max.30 °C and humidity 40 % to 70 % on average.
- Keep rule: Use older oil seals stored, first.
- Avoid: Direct/indirect ray of sun, ozone
- When storing oil seals in a worksite, keep them in sealed containers to protect them from dusts, sands, and other contaminations, as well as mechanical damages caused by various equipment or subjects dropped.
- Avoid oil seals from being stacked for storage which may lead to deformation of seal edges due to their own weight.

(2) Handling

Keep the following cautions at handling.

- Do not damage seals by knife or screw driver when opening wrap.
- Do not place seals for long time on table without sheet cover, due to chance of dust or sand adhesion.
- Do not hang by wire, string, or nail, which deforms or damages seal lip.
- Do not use cleaners, solvents, corrosive fluids, or chemical liquid. Use kerosene when washing seals.

(3) Mounting

- 1) Before mounting, confirm that there is no damage, no dirt or foreign particles on the seals.
- 2) Apply suitable, clean lubricant to the seal lip for initial lubrication. For oil seals with a minor lip, pack clean grease between main lip and minor lip (Fig. 1.7.1).

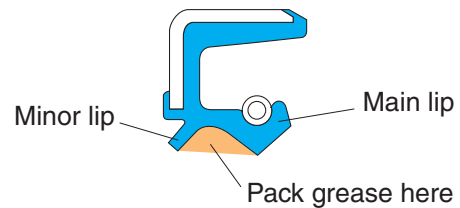

Fig. 1.7.1 Prelubrication for seals with minor lip

3) Recommended grease

- Small penetration (soft grease)
 - Small penetration change by temperature
 - Wide serviceable temperature range
 - Lithium base type (avoid silicone base grease for silicon rubber seal, urea base grease for fluoroc rubber seal which may harden or deteriorate seal rubber)
- 4) When seal is mounted at cold area, warm seal up to have seal flexibility and then mount it.
 - 5) To avoid damage on seal lip and shaft surface when seal is mounted onto shaft. Shaft edge should be chamfered or 0.2 mm smaller guide as illustrated below (Fig.1.7.2).

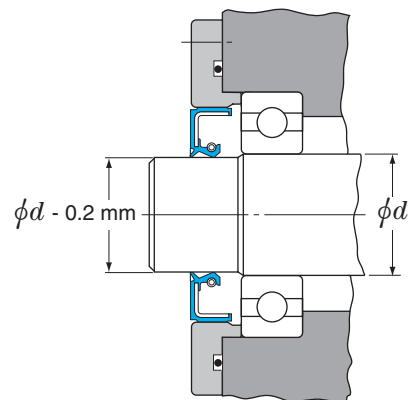
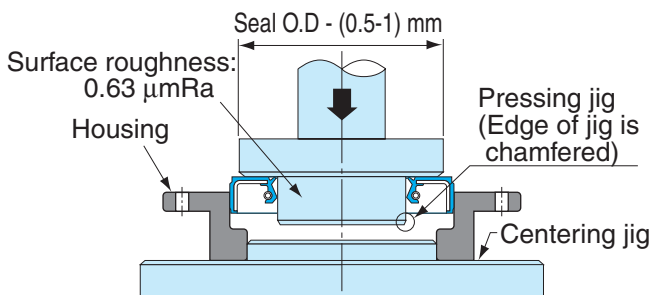

Fig. 1.7.2 Recommended shaft profile and machine construction to avoid damaging shaft surface

6) When seal is pressed into housing bore, use pressing jig as shown in Fig. 1.7.3. When press-fitting an oil seal into the housing bore in the opposite direction, use the pressing jig as shown in Figs.1.7.4 and 1.7.5.

Jig for shouldered housing bore



Jig for straight housing bore

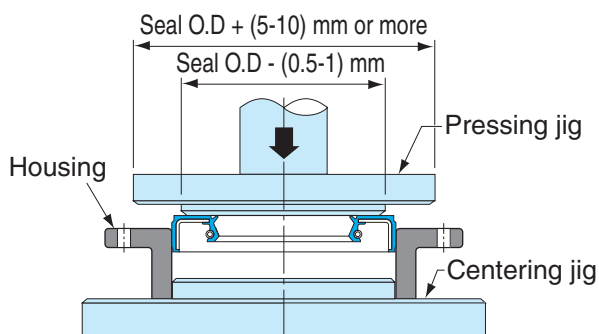

Fig. 1.7.3 Recommended seal press-fitting jigs

Seal press fit at a slant may cause the fit surface to have tear or scuffing and leakage. To ensure good sealing performance, seals need to be mounted at right angles to shafts. For right angled mounting, press the seal down thoroughly to reach the housing shoulder (Fig. 1.7.4).

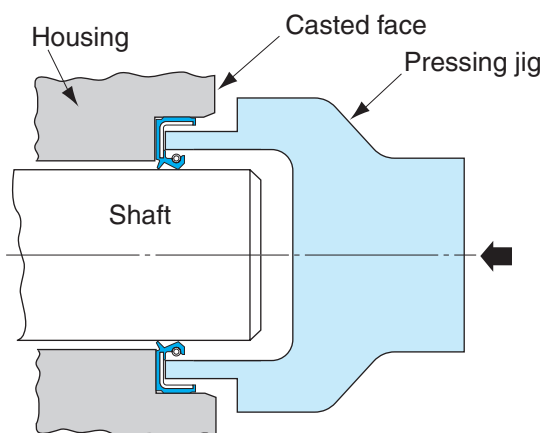

Fig. 1.7.4 Seal press-fitting jig for shouldered housing bore in the opposite direction

To mount seal into a straight housing bore, the jig should be contacted with the machine-finished surface to mount the seal at right angles to the housing bore (Fig. 1.7.5).

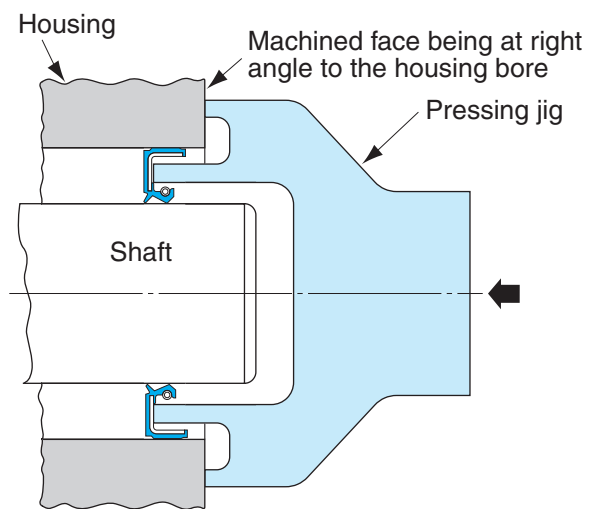
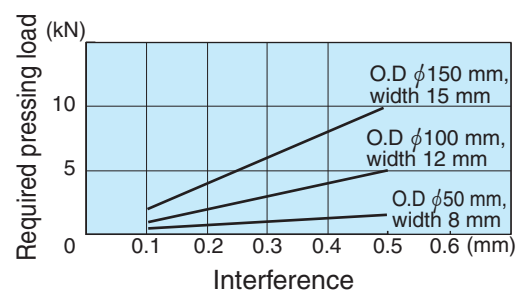

Fig. 1.7.5 Seal press-fitting jig for straight housing bore in the opposite direction

In the case of O.D wall being rubber, press the seal into housing by constant pressure 2-3 times at a constant speed to prevent spring back. Fig. 1.7.6 shows typical seal pressing load required to press-fit an oil seal into the housing. Refer to the shown data when press-fitting oil seals. Based on these diagrams, decide a slightly higher pressing load.

Measuring conditions
No lubricant
Surface roughness of housing bore: 1.6 μmRa

O.D wall: Rubber (Rubber material: NBR)



O.D wall: Metal

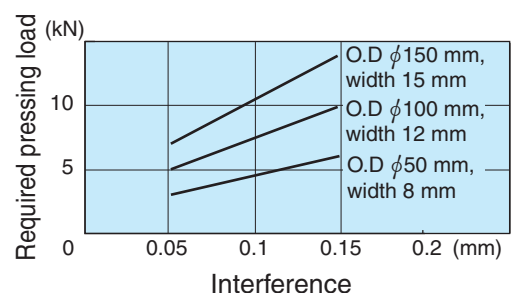

Fig. 1.7.6 Relation between required seal pressing load and seal interference

1.7 Handling of seal

7) In case of shaft has spline, keyway, or holes, use seal protecting jig to prevent lip damage as illustrated below (Fig. 1.7.7).

If difficult to use jig, remove sharp corners, round the edges and coat enough grease.

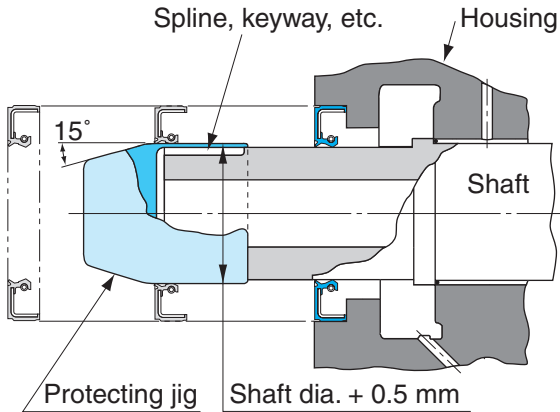

Fig. 1.7.7 Seal protecting jig for spline, keyway, holes on shaft

All the corners of the jig should be chamfered. Do not use a jig made from soft material such as aluminum; such a jig is prone to damages and a damaged jig may scratch the seal lip. Use a protecting jig made from steel or stainless steel.

8) When heavy housing with seal is assembled with shaft, or when long or heavy shaft is inserted into seal, seal damage should be avoided. Use the following guide jig to get centering (Figs. 1.7.8 and 1.7.9).

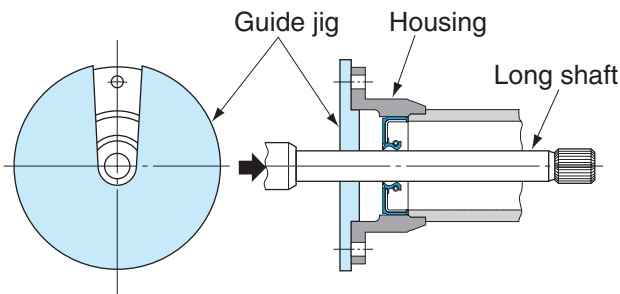

Fig. 1.7.8 Guide jig for inserting of long shaft into seal bore

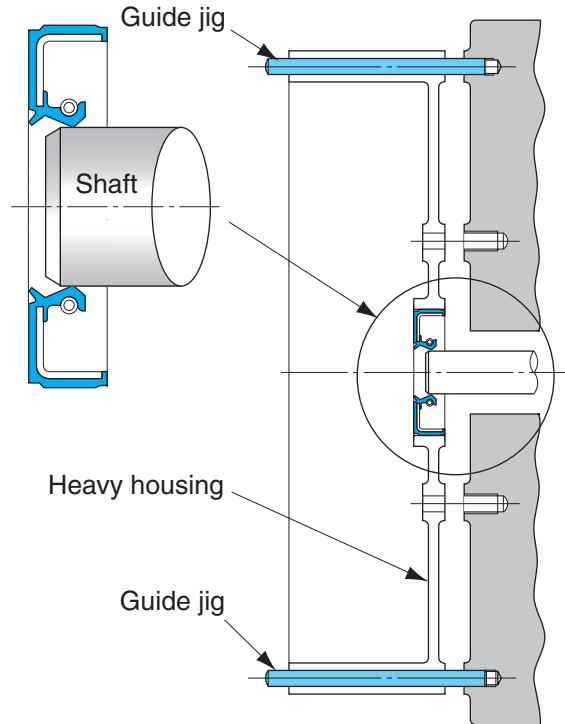

Fig. 1.7.9 Guide jig for mounting of heavy housing with seal onto shaft

If these methods cannot be applied (Fig. 1.7.9), assemble shaft and housing first, then mount seal.

9) When oil seal is removed, use a new oil seal instead of the seal used.

Contact position of new seal lip on the shaft should be displaced to 0.5 mm (1~2 mm for large-size seals) from the old seal lip contact position by applying spacer as illustrated below (Fig. 1.7.10).

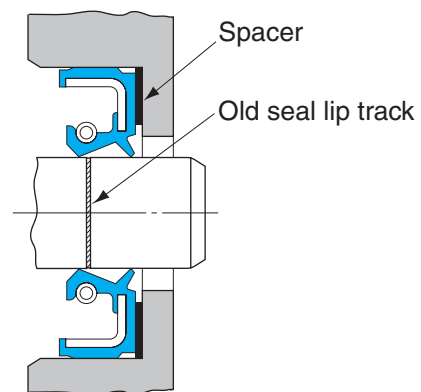

Fig. 1.7.10 Avoid old seal lip track

(4) Mounting of split MS-type seals

MS-type seal has one split in order to have easy mounting on to long shaft or complicated shaped shaft (Fig. 1.7.11).



Fig. 1.7.11 MS-type seal with one split

When fitting the oil seal of this type, do not bond the cut portion of it with adhesive agent. If bonding is absolutely necessary, pay close attention to avoid any step around the seal lip.

Mount a split MS-type seal on to the shaft as following procedure:

- ① Mount the spring first and connect spring by the hook (Fig. 1.7.12).
- ② Mount the seal and position split area to upwards on the shaft.
- ③ Place the spring on the seal spring groove, position spring joint area to 45° apart from seal split area.
- ④ Fix the seal by seal fixing ring. If seal fixing ring is split type, avoid position of ring split area from seal split area.



Fig. 1.7.12 Spring hook connection

(5) Cautions after mounting

- 1) If the area near the oil seal is painted, make sure to keep the seal lip and the shaft area in contact with the lip free from paint.
- 2) Avoid cleaning on the mounted seal area as much as possible. If cleaning is inevitable, perform it quickly and wipe off the detergent immediately when completed.

Small talk 5

A murmur of a female staff member

One day, a female staff member over-heard a conversation:

Third-year sales rep: "The rubber of oil seals is petroleum-based (naphtha-base), isn't it?"

Engineering leader: "Nitrile rubber and acrylic rubber are synthetically produced based on naphtha, but silicone rubber is made from silicon, which can be found naturally. Fluorocarbon rubber is produced synthetically from fluorine compounds extracted from fluorite, which is known for its fluorescent light emission."

"Oh, how knowledgeable our engineering leader is!" murmured the female staff member, impressed.

1.8 Causes of seal failures and countermeasures

(1) Causes of seal failures

To identify the causes of seal failure and take proper measures, it is critical to observe the seal lip closely and evaluate the failure in all respects, such as shaft surface

roughness, contaminants and lubrication. Causes of major seal failure are listed below (Table 1.8.1).

Table 1.8.1 Causes of seal failures

Factor					
1st	2nd	3rd	4th	5th	
Leakage from seal	From lip	Damages on lip	Burrs on shaft chamfer Spline, keyway on shaft Entry of foreign materials Wrong handling		
		Lip turned backward	Small shaft chamfer Center off set at mount Excessive inside pressure		
Missing spring		Small shaft chamfer Center off set at mount Caused by Stick slip*			
Lip hardened		High oil temperature Poor lubrication Excessive inside pressure			
Lip softened		Improper rubber Long time dip in cleaner, solvent			
Heavy wear on shaft		Entry of foreign materials Chemical wear Poor lubrication Caused by Stick slip*	High oil temperature Extreme pressure additives		
Heavy wear on lip		Poor lubrication Excessive internal pressure Rough shaft surface finish Entry of foreign materials			
Uneven wear on lip		Excessive eccentricity at mount Inclined seal mounting			
Rough face, Steaks on lip		Entry of foreign materials Poor lubrication			
Tear at seal heel bottom		Wrong handling Reaction by impact pressure Excessive inside pressure			
Lip deformation (small interference)		High oil temperature			
Lip face contact		Excessive inside pressure Minus pressure between lips Big shaft runout			
Lip tear		Larger shaft diameter Caused by Stick slip* Reaction by impact pressure	Poor lubrication Improper rubber		
No abnormality on seal		Smaller shaft diameter Improper shaft roughness Damages on shaft Lead machining on shaft Poor lip followability	Small interference		
		From fitting area	Peeling, Scuffing, Damages, Deformation,		
			Inclined mounting on seal	Smaller housing bore diameter Small housing bore chamfer Rough housing bore surface finish Improper mounting tool	Large interference
			No abnormality on seal	Larger housing bore Smaller seal O.D Rough housing bore surface finish Damages or blowholes on housing bore Wrong direction of seal mounting	Small interference Small interference
			Poor lip followability	Big shaft runout Big eccentricity Small interference Lip high rigidity Poor low temperature resistance	

* Stick slip:
A friction related phenomena in which the sealing element tends to adhere and rotate with the shaft surface momentarily until the elastic characteristics of the sealing element overcome the adhesive force, causing the seal lip to lose contact with the rotating shaft long enough to allow leakage.
This cycle repeats itself continuously and is normally associated with non-lubricated and boundary-lubricated conditions.

(2) Causes of seal failures and countermeasures

Table 1.8.2 below lists the possible causes of seal failures and countermeasures.

Table 1.8.2 Causes of seal failures and countermeasures (1)

Oil leakage from lip (1)



Symptom	Phenomenon	Causes	Countermeasures
Damages on sealing edge		<ol style="list-style-type: none"> 1) Sharp edge or burrs on shaft chamfer 2) Shaft spline or keyway 3) Entry of foreign materials 4) Poor handling 	<ul style="list-style-type: none"> • Remove burrs and polish • Use shaft protecting jig (See Fig. 1.7.7 on page 28.) • Clean work shop • Improve handling manner (Consult JTEKT.)
Lip turned backward		<ol style="list-style-type: none"> 1) Too small chamfer on shaft end 2) Center offset between shaft and housing 3) Excessive inside pressure happened 	<ul style="list-style-type: none"> • Correct shaft chamfer (See Fig. 1.5.1 on page 19.) • Improve center offset (Consult JTEKT.) • Apply high pressure proof seal or breather (vent)
Missing spring		<ol style="list-style-type: none"> 1) Inadequate shaft end chamfer 2) Center offset between shaft and housing 3) Caused by Stick slip 	<ul style="list-style-type: none"> • Improve shaft end chamfers (See Fig. 1.5.1 on page 19.) • Improve center offset (Consult JTEKT.) • Improve lubrication including pre-lubricating on seal
Lip hardened		<ol style="list-style-type: none"> 1) Temperature exceeded seal service temperature range 2) Poor lubrication 3) Excessive inside pressure happened 	<ul style="list-style-type: none"> • Change rubber material to high temperature proof rubber (See Table 1.4.2 on page 16.) • Improve lubricating method and lubricant supply volume • Apply high pressure proof seal or breather (vent)
Lip softening		<ol style="list-style-type: none"> 1) Mis-selection of rubber material 2) Long time dip in cleaning oil or organic solvent 	<ul style="list-style-type: none"> • Change rubber to material not swelling in lubricant (See Table 1.4.2 on page 16.) • To clean the seal, apply the oil used for lubrication as cleaning oil. In an application where grease is used for lubrication, use kerosene as cleaning oil
Heavy wear on shaft		<ol style="list-style-type: none"> 1) Entry of foreign materials 2) Chemical wear due to high temperature or excessive pressure additive 3) Poor lubrication 4) Caused by Stick slip 	<ul style="list-style-type: none"> • Attach prevention device for entry of foreign materials • Take countermeasure to prevent high temperature and change lubricants (Consult JTEKT.) • Improve lubrication on lip including pre-lubricating (Improve quantity of lubricant or lubricating method)

Table 1.8.2 Causes of seal failures and countermeasures (2)

Oil leakage from lip (2)

Symptom	Phenomenon	Causes	Countermeasures
Heavy wear on lip	Rough face, Streaks 	1) Poor lubrication 2) Rough shaft surface finish 3) Entry of foreign materials	<ul style="list-style-type: none"> • Take pre-lubrication on lip • Improve lubrication • Improve shaft surface finish (See page 19.) • Attach prevention device for foreign materials
	Hardening, Cracks 	Excess heat generation due to 1) Poor lubrication 2) Running under conditions beyond specifications a) Excess peripheral speed b) Excessive inside pressure	<ul style="list-style-type: none"> • Improve lubrication • Examine cause of heat source • Change rubber to heat proof rubber (See Table 1.4.2 on page 16.) • Apply high pressure proof seal or breather (vent)
	Dents 	<ul style="list-style-type: none"> • Excessive inside pressure 	<ul style="list-style-type: none"> • Apply high pressure proof seal or breather (vent)
Lip uneven wear	Wear track width is uneven. Max. wear positions of main lip and minor lip are same.  <p>Uneven wear</p>	1) Center offset between shaft and housing 2) Inclination of shaft	<ul style="list-style-type: none"> • Examine misalignment for shaft to housing (Take countermeasure to reduce offset)
	Wear track width is uneven. Max. and Min. wear areas are located 180° apart. (Main and minor lips show opposite pattern.)  <p>Uneven wear</p>	Inclined seal was mounted into housing 1) Improper housing bore diameter 2) Improper housing bore chamfer 3) Improper housing bore corner radius 4) Improper mounting tool	<ul style="list-style-type: none"> • Correct housing bore diameter (See Table 1.5.2 on page 19.) • Correct housing bore chamfer (See Fig. 1.5.3 on page 20.) • Correct housing bore corner radius (See Fig. 1.5.4 on page 20.) • Improve mounting tool (Consult JTEKT.)

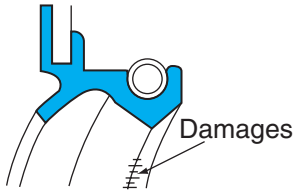
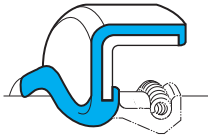
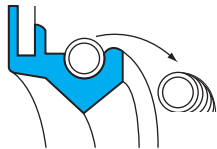
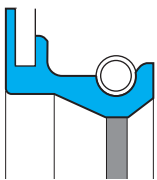
Table 1.8.2 Causes of seal failures and countermeasures (3)

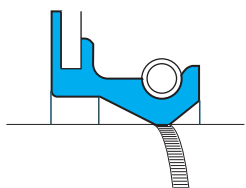
Oil leakage from lip (3)





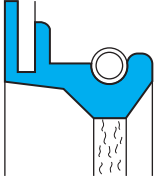
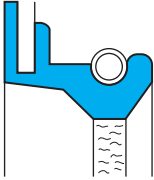
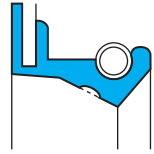
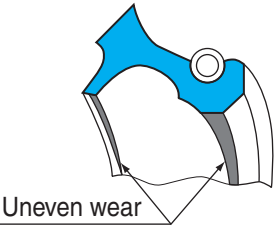
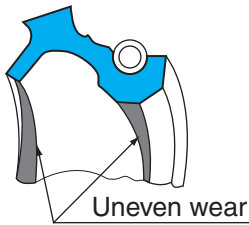





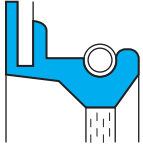
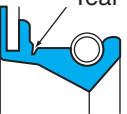
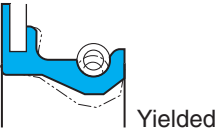

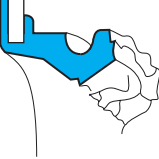
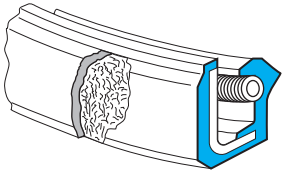
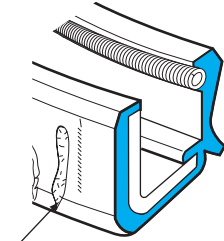
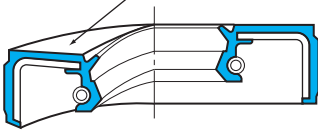
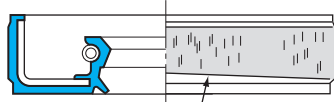













Symptom	Phenomenon	Causes	Countermeasures
Rough face and streaks on lip	Rough face and streaks on sealing edge 	1) Entry of foreign materials 2) Poor lubrication	<ul style="list-style-type: none"> • Attach prevention device for entry of foreign materials • Improve lubrication
Tear at seal heel bottom	 Tear	1) Improper handling 2) Excessive inside pressure 3) Reaction by impact pressure	<ul style="list-style-type: none"> • Improve handling manner (Consult JTEKT.) • Apply high pressure proof seal or breather (vent) • Prevention of impact pressure by design change of machine structure
Lip deformation	Reduction of tightening interference due to rubber hardened  Yielded	<ul style="list-style-type: none"> • Oil temperature rose up during operation 	<ul style="list-style-type: none"> • Change rubber to high temperature proof rubber (See Table 1.4.2 on page 16.) • Examination of and countermeasure against the cause of temperature increase are required.
Lip face contact	Whole lip face shows sliding contact pattern  Sliding pattern	1) Excessive inside pressure happened 2) Minus pressure happened between lips 3) Big shaft runout 4) Larger shaft diameter	<ul style="list-style-type: none"> • Prevent excess pressure (change of machine structure) • Give clearance for minor lip • Improve shaft accuracy • Correct shaft diameter
Lip tear		1) Caused by Stick slip a) No or poor lubrication b) Mirror surface finish on shaft c) Excessive shaft surface speed 2) Impact pressure	<ul style="list-style-type: none"> • Improve lubrication including pre-lubricating on seal • Correct shaft surface finish to (0.63-0.2) μmRa and (2.5-0.8) μmRz • Review machine structure to reduce impact pressure
–	No abnormality on seal but oil leakage is observed	1) Smaller shaft diameter 2) Improper shaft roughness 3) Damages on shaft 4) Lead machining on shaft 5) Poor lip followability a) Big shaft runout b) Big housing-bore eccentricity c) Small interference d) Lip high rigidity e) Poor low temperature resistance 6) Wrong direction of seal mounting 7) Adhesion of foreign particles at mounting	<ul style="list-style-type: none"> • Improve and correct shaft accuracy • Improve shaft surface finish (0.63-0.2) μmRa and (2.5-0.8) μmRz • Remove sharp corners and burrs, or replace shaft • Change the grinding method (avoid axial feed) • Reduce center offset (Consult JTEKT.) • Improve and correct shaft accuracy • Use low torque seal • Change rubber material to low temperature proof one (See Table 1.4.2 on page 16) • Correct seal direction • Improve handling manner

Table 1.8.2 Causes of seal failures and countermeasures (4)

Oil leakage from seal fitting area

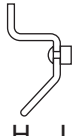
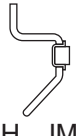
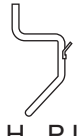
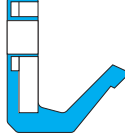
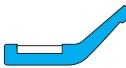
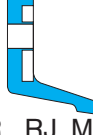
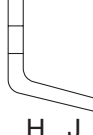
Symptom	Phenomenon	Causes	Countermeasures
Peeling, scuffing on O.D wall		<ol style="list-style-type: none"> 1) Smaller housing bore 2) In adequate housing bore chamfer 3) Rough housing bore surface finish 4) Centering offset between housing and seal mounting 	<ul style="list-style-type: none"> • Correct housing bore diameter (See Table 1.5.2 on page 19.) • Correct housing bore chamfer (See Fig. 1.5.3 on page 20.) • Improve mounting tool and handling manner (See Figs. 1.7.3 to 1.7.5 on page 27.)
Damages on O.D wall	 Damage	<ol style="list-style-type: none"> 1) Burrs on housing bore 2) Damages, or blowholes on housing bore 	<ul style="list-style-type: none"> • Remove burrs, chips • Repair housing bore to eliminate damage, blowhole
Deformation	 Deformation	<ol style="list-style-type: none"> 1) Smaller housing bore 2) Small housing bore chamfer 3) Improper seal mounting tool 	<ul style="list-style-type: none"> • Correct housing bore diameter (See Table 1.5.2 on page 19.) • Correct housing bore chamfer (See Fig. 1.5.3 on page 20.) • Improve mounting tool (Consult JTEKT.)
Seal inclined mounting	Uneven fitting marks on seal O.D face  Inclined fitting mark	<ol style="list-style-type: none"> 1) Smaller housing bore 2) Small housing bore chamfer 3) Poor parallel accuracy between mounting tool and housing 	<ul style="list-style-type: none"> • Correct housing bore diameter (See Table 1.5.2 on page 19.) • Correct housing bore chamfer (See Fig. 1.5.3 on page 20.) • Improve mounting tool (Consult JTEKT.)
–	No abnormality on seal but oil leakage is observed	<ol style="list-style-type: none"> 1) Larger housing bore 2) Smaller seal O.D 3) Rough housing bore surface finish 4) Damages or blowholes on housing bore 5) Wrong direction of seal mounting 	<ul style="list-style-type: none"> • Correct housing bore diameter (See Table 1.5.2 on page 19.) • Replace seal • Improve housing bore surface finish (See Table 1.5.3 on page 20.) (In urgent cases, apply liquid gasket to housing bore.) • Remove damages and blowholes • Correct seal direction

1.9 Seal dimensional tables (Contents)

		Type				Page	
Standard type seals	Metal O.D wall seals d_1 7~540	 HM	 HMA	 HMS	 HMSA	36	
	Rubber O.D wall seals d_1 6~300	 MH	 MHA	 MHS	 MHSA		
Special seals	YS type seals d_1 220~1 640	 YS	 YSN	 YSA	 YSAN	54	
	Assembled seals d_1 115~405	 HMSH	 HMSH...J	 HMSH...J	 HMSH...J	68	
	Full rubber seals d_1 10~3 530	 MS				72	
	MORGOIL seals Seal inner rings d_1 167~1 593	 MS...J	 MS...NJ	 H...J	 H...JM	 H...PJ	78
	Scale seals Scale covers d 195~1 595	 WR	 WR...BJ	 WR...RJ, MH...J		 H...J	80
	Water seals d_1 219.2~1 460	 XMH	 XM, XMHE				84
	V-rings d 38~875	 MV...A				86	

d_1 (12)~(16)

Boundary dimensions, mm			Metal O.D wall																Rubber O.D wall																			
d_1	D	b	HM				HMA				HMS				HMSA				MH				MHA				MHS				MHS A							
			N	A	S	F	N	A	S	F	N	A	S	F	N	A	S	F	N	A	S	F	N	A	S	F	N	A	S	F	N	A	S	F				
12	28	7									●																				■				■			
	30	9									○																											
	32	5																□																				
	32	7																									□							■				
13	20	5					○																								□							
	25	4	●																																			
	25	7																													■		□					
	28	5	○																																			
	28	7									●																□				□		□					
	30	8																									□							■				
	30	9									○																											
14	20	3					○																															
	24	6	○															■	□								■	□	□		■							
	24	7									○																				□							
	25	4	●																																			
	26	7																				□																
	28	7									○			○													■				■							
	32	9									○																□											
	34	6	○																																			
15	20	5					○																															
	21	3					○	○		○																												
	22	4	●		○																																	
	22	7																													■							
	23	3					○																															
	24	4.5					○																															
	24	7									○																				□							
	25	4	●															■																■				
	25	5																																■				
	25	7									●	○	○					■									■				■							
	27	6																				□																
	28	6																													■							
	28	7									●	○	○														■											
	30	4	○															■																■				
	30	5	○		○									○				□																■				
	30	7									●		○	●	○												■		□		■	□	□					
	30	9									○																□											
	30	12																																■				
	32	6																□																				
	32	7									●																				■							
32	9									○			○													□							■					
35	5																																■					
35	6	○															■																					
35	7									●																■		□										
35	8																									■				■								
16	22	3.5																				□	□															
	24	4	●															■				□	□								■							
	26	7									●			○								□	□								■	□						

d_1 (24)~(28)

Boundary dimensions, mm			Metal O.D wall																Rubber O.D wall															
d_1	D	b	HM				HMA				HMS				HMSA				MH				MHA				MHS				MHSA			
			N	A	S	F	N	A	S	F	N	A	S	F	N	A	S	F	N	A	S	F	N	A	S	F	N	A	S	F	N	A	S	F
24	45	10									○																							
25	32	4																	■															
	32	8									●																							
	33	4					○																											
	35	5	●		○														■															
	35	6																													■			
	35	7									●																				■			
	35	8									●																							
	38	5	●		○														■															
	38	7									●		○	○	○												■				■			□
	38	8									●			○	●																■	□		
	40	5	●		○														■															
	40	6	●			○																												
	40	7													●																■			
	40	8									●			○	●			○									■	□	□	□	■	□	□	□
	40	10									●																□				■			
	42	5																									□							
42	8									●																				■				
42	11									○																								
44	7									○		○																						
45	5	○																■																
45	7									●				○												□				■	□			
45	8									●				●												■	□			■	□			
45	10									○				○												□				■				
45	11													○												■			□	■			□	
47	5	●																□			□													
47	6	○								●		○						□								■								
47	7																									□				■				
47	8													○																				
48	8									●																□								
50	9									○																□								
50	12									●				○												□				■				
52	7																													■				
52	10									○																								
52	12									●																				■				
62	11																													■	□			
26	36	8									○		○																		□			
	38	8									●		○		●								□								■			
	40	7													●																			
	40	8																													□			
	42	7													○																			
	42	8									○			○	●								■	□	□		■							
	45	7																					□											
	48	11									○				○																			
27	40	8									●		○																					
	47	11									○				○												■							
28	35	5																	■															

d_1 (30)~(35)

Boundary dimensions, mm			Metal O.D wall																Rubber O.D wall															
d_1	D	b	HM				HMA				HMS				HMSA				MH				MHA				MHS				MHSA			
			N	A	S	F	N	A	S	F	N	A	S	F	N	A	S	F	N	A	S	F	N	A	S	F	N	A	S	F	N	A	S	F
30	48	7											●																				■	
	48	8										●																						
	50	5	○																■															
	50	7										○			○																		■	
	50	8										●		○	●		○								■	□		□	■	□				
	50	9										○																						
	50	10										○																						
	50	11										●		○	○	●		○								■			□	■	□	□		
	50	12										○																						
	52	8																															■	
	52	10																							□									
	52	12										●													□									
	55	5																		■														
	55	12										●														■							■	
	56	5	○																		□													
	62	7																															□	
62	8																															□		
62	10																															■		
32	43	7																														□		
	43	10										●																						
	44	9										●																						
	45	5	●																	■												□		
	45	7																														□		
	45	8										●			●										■				■		□			
	46	8										○													□									
	47	8										●																						
	48	6	○																															
	48	8										●		○	●		○																■	
	52	5	●																		■													
	52	8										○														■			□	■	□	□		
	52	11										●		○	●																		□	
54	10																															■		
33	50	7									○																							
	52	7									○														□									
34	42	5																														□		
	44	8																														□		
	46	8										●																						
	48	8										●																				■		
	50	7																							□									
	54	11										●			●																		■	
35	45	5	●	○																														
	47	5	●	○																					□									
	47	7										●														■			□					
	48	5																								■								
	48	7																														■		
	48	8										●		○	●											■		□	■	□				
	50	6	○																							■	□							

Standard types

d_1 (35)~(45)

HM HMA HMS HMSA
MH MHA MHS MHSA

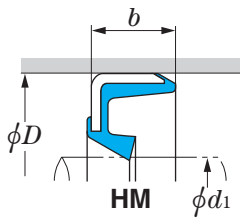

HM



HMA



HMS



HMSA

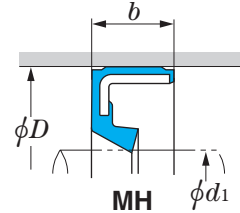

MH



MHA



MHS



MHSA

Remarks

- 1) Seals marked ● and ■ are always in stock.
- 2) Seals marked ○ and □, JTEKT owns molding dies for production.
- 3) Seal number is constructed by combination of type code and dimensional numbers (bore diameter, outside diameter and width).
Example: HMSA55729(55×72×9 mm).
- 4) Rubber code N represents nitrile rubber, A: acrylic rubber, S: silicone rubber, and F: fluorocarbon rubber.

d_1 (35)~(40)

Boundary dimensions, mm			Metal O.D wall																Rubber O.D wall															
d_1	D	b	HM				HMA				HMS				HMSA				MH				MHA				MHS				MHSA			
			N	A	S	F	N	A	S	F	N	A	S	F	N	A	S	F	N	A	S	F	N	A	S	F	N	A	S	F				
35	50	7									●	○	○														■		□		■			
	50	8									●	○	○	●		○											■				■	□		□
	50	11																									■				□			
	52	5																□																
	52	7																																
	52	8																													■			
	52	9																									□				■			
	52	10									●		○														□		□					
	52	11												●																	■			
	52	12									●																□				■	□		
	55	5	●		○																													
	55	7												○																	□			
	55	8									●			●		○											■	□	□		■			
	55	9									○																							
55	11											○	●		○											□		□	□	■		□	□	
55	12																													■				
60	12									●			●		○											□				■				
62	10									●																				■				
36	50	7									●																■				■	□		
	50	10									●																							
38	45	8				○																												
	50	5	●																															
	50	8									●																■		□		■		□	
	52	6				○																					□							
	52	9																													■			
	55	6	○		○																													
	55	8									●			●		○											□				■			
	55	9									○			○																	■			
	58	5																□																
	58	7									●																				□			
58	8												●													□				■				
58	11									●	○	○	●		○											■		□		■		□		
40	50	6																									□							
	52	5	●		○	○												■																

d_1 51~(62)

Boundary dimensions, mm			Metal O.D wall																Rubber O.D wall																			
d_1	D	b	HM				HMA				HMS				HMSA				MH				MHA				MHS				MHSA							
			N	A	S	F	N	A	S	F	N	A	S	F	N	A	S	F	N	A	S	F	N	A	S	F	N	A	S	F	N	A	S	F				
51	63	6					○																															
52	65	6																	□																			
	70	9									●				●												□				■							
	75	9									○				●																							
	75	12									●		○		●												□		□		■	□						
53	78	12																									□			□								
55	70	6	●		○	○													□																			
	70	7												○																								
	70	9									●		○																						■			
	72	7	●		○									○					■																□			
	72	9									●		○		●	○		○									■	□			■							
	74	6	○																																			
	75	12									●																											
	78	6																	■																			
	78	7												○																					□			
	78	9									○	○			●			○									■			□	■				□			
	78	12									●	○	○	○	●	○		○									■	□	□	□	■	□		□				
80	12									○	○			●												□				■								
85	7	○			○																																	
85	14									○	○	○		●												□	□	□		■								
56	70	6	○																□																			
	78	9																																	□			
	78	12									●					○																			■			
58	72	6	●																□																			
	72	9									●																											
	75	9									●					○																			■			
	80	9									○																								■			
	80	12									○		○		●			○									□				■				■			
60	75	6	●			○													■																			
	75	7												○																								
	75	9									●		○		●			○									■				■							
	75	10									●		○	○																								
	78	7												○					□																□			
	78	9									●		○	○	●												□				■	□		□				
	80	12									●	○																							■			
	82	6	●																																			
	82	7												○					■				□												■			
	82	9									●		○		●												■			□	■				□			
	82	12									●		○		●		○	○									■	□	□	□	■	□	□	□				
	82	14													●																							
	85	12									○																□	□										
	90	7	●																																			
90	11																																	■				
90	12																																	□			□	
90	14									●		○		●												■	□	□		■								
62	75	6																	□																			
	75	9									●																											

d_1 (140)~(210)

Boundary dimensions, mm			Metal O.D wall																Rubber O.D wall															
d_1	D	b	HM				HMA				HMS				HMSA				MH				MHA				MHS				MHSA			
			N	A	S	F	N	A	S	F	N	A	S	F	N	A	S	F	N	A	S	F	N	A	S	F	N	A	S	F	N	A	S	F
140	170	14									●	○	○		●			○									□			□	■	□		□
	185	16									○	○															■				■	□	□	□
145	175	12												○																	□			
	175	14									●		○		●	○	○	○									□			□	■			
	190	16																								□	□							
150	180	12												○																	□			
	180	14									●	○	○	○	●	○	○	○									■				■	□	□	□
	180	16													●																■			
155	180	15									○																							
	185	15									○	○																						
	190	14																															□	
	200	20									○	○			●	○																		
160	190	12												○																				□
	190	14									●	○	○		●	○	○										■							
	190	16									●	○	○		●	○											□		□	□	■	□	□	□
	200	15																															□	
165	195	14																									■				■			□
	220	20									○																							
170	200	12																																□
	200	16									●				●			○									□			□	■			□
	205	12													○																			
	205	16									●	○																						
	205	18													●																			
	210	15																									■		□					
	225	16													○																			
	225	20									○				●																			
175	230	20									○																							
180	210	12																																□
	210	15									○																							
	210	16									●		○		●		○	○									□				■	□	□	□
	215	16									○	○	○	○																				
	215	18													●																			
	220	15									○																							
	225	20									○																							
	235	20									○																							
190	220	14									●		○																					
	220	15																									□			□				
	225	16									●		○		●	○		○																
	245	22									○	○																						
200	230	15									●																							
	235	16									○																							
	235	18													●																			
	240	16									○																							
	240	20									○		○		●		○														□	□		□
	255	22									○																							
205	260	23									○																							
210	240	15									○																□			□				

Standard types

d_1 (210)~540

HM HMA HMS HMSA
MH MHA MHS MHSA

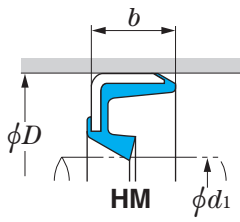

HMA



HMS



HMSA

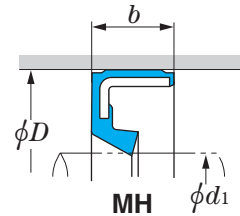

MHA



MHS



MHSA

Remarks

- 1) Seals marked ● and ■ are always in stock.
- 2) Seals marked ○ and □, JTEKT owns molding dies for production.
- 3) Seal number is constructed by combination of type code and dimensional numbers (bore diameter, outside diameter and width).
Example: HMSA55729(55×72×9 mm).
- 4) Rubber code N represents nitrile rubber, A: acrylic rubber, S: silicone rubber, and F: fluorocarbon rubber.

d_1 (210)~280

Boundary dimensions, mm			Metal O.D wall																Rubber O.D wall																			
d_1	D	b	HM				HMA				HMS				HMSA				MH				MHA				MHS				MHSA							
			N	A	S	F	N	A	S	F	N	A	S	F	N	A	S	F	N	A	S	F	N	A	S	F	N	A	S	F	N	A	S	F				
210	250	16									○	○	○	●																								
	250	18									○																											
	250	20									○	○		●	○	○																						
	265	23									○				○																							
	265	25									○				○																							
220	250	15									○	○	○													□												
	250	16																									■	□	□	□								
	255	16									○			○												□	□	□										
	255	18									○			○				○													■	□	□	□				
	260	20																○								□	□											
	260	22									○			●	○	○																						
	275	23									○																											
230	260	15									○			○												□												
	260	20									○		○	●		○																						
	270	15																								□												
	270	16																													■	□	□	□				
	270	20																													■	□	□	□				
	285	23									○																											
240	270	15									○		○													□												
	270	20																													■							
	275	16									○		○	○												□					■	□						
	275	18												●																								
	280	19									○	○	○	●																								
250	280	15									○		○													□												
	285	18												●												□					□	□	□					
	310	25									○	○		●																								
260	300	20																								□												
	320	25									○		○	●		○																						
270	330	25											○	●	○	○																						
280	310	16																								□												
	320	18									○		○																									
	320	22												●		○															□							
	330	24																								□												
	340	28									○			●		○																						

YS type

d_1 220~340

YS YSN YSA YSAN

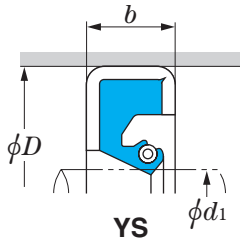

YSN



YSA



YSAN

Remarks

- 1) For seals marked \bigcirc , JTEKT owns molding dies for production.
- 2) Seal number is constructed by combination of type code and dimensional numbers (bore diameter, outside diameter and width).
Example: YS32036018 (320×360×18 mm).
- 3) Seal number marked $\bigcirc*$ have suffix -1.
- 4) Seals with spacers are available.
Seal number with spacers is referred on right side page.
- 5) Rubber code N represents nitrile rubber, F: fluorocarbon rubber, and K: hydrogenated nitrile rubber.

d_1 220~(310)

Boundary dimensions, mm			Seal type									
d_1	D	b	YS			YSN			YSA		YSAN	
			N	F	K	N	F	K	N	F	N	F
220	255	16				\bigcirc						
230	264	16				\bigcirc						
240	275	16				\bigcirc						
250	285	16				\bigcirc						
255	315	25	\bigcirc									
265	305	18	\bigcirc			\bigcirc						
270	330	25	\bigcirc									
280	320	18	\bigcirc			\bigcirc						
	330	20	$\bigcirc*$									
	340	25	\bigcirc			\bigcirc						
290	330	18	\bigcirc									
	340	20	\bigcirc									
	350	25	\bigcirc									
300	350	28							\bigcirc			
	340	18	\bigcirc	\bigcirc		\bigcirc	\bigcirc					
	340	20	\bigcirc									
300	340	25	\bigcirc									
	345	20	\bigcirc									
	345	22	\bigcirc									
	350	20	$\bigcirc*$									
	350	25	\bigcirc									
	350	29							\bigcirc			
	360	25	\bigcirc			\bigcirc						
360	28							\bigcirc				
304	342.1	17.5	$\bigcirc*$									
304.8	342.9	17.5	$\bigcirc*$									
	355.6	20.6	\bigcirc									
	355.6	25.4	\bigcirc									
305	355	23	\bigcirc									
	355	25	\bigcirc									
310	350	18	\bigcirc									
	350	19	\bigcirc									
	350	20	\bigcirc			\bigcirc						
	360	20	\bigcirc									
	360	25	\bigcirc						\bigcirc			

Example of seal number with spacer

Example 1 **YS 320 360 18 D5**
 Spacer width: 5 mm

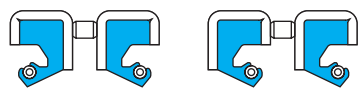
Example 2 **YS 320 360 18 2D5**
 Spacer width: 5 mm

Various width spacers are available as like 10 mm.

d_1 (310)~340

Boundary dimensions, mm			Seal type									
d_1	D	b	YS			YSN			YSA		YSAN	
			N	F	K	N	F	K	N	F	N	F
310	370	25	○	○		○			○*			
	370	28							○			
315	355	20	○									
	360	20	○									
	365	20	○									
	375	25	○									
	375	28							○			
320	360	18	○			○						
	360	20	○									
	360	25	○		○	○						
	370	20	○									
	370	25	○									
	380	25	○			○			○			
	380	28							○	○		
320.68	371.48	25.4	○									
325	365	20	○									
	375	25	○									
330	370	18	○									
	370	20	○									
	370	25	○									
	380	25	○									
	390	25	○			○						
	390	28							○			
330.2	368.3	17.5	○*									
335	375	20	○									
	385	25							○			
	395	28							○			
336.6	374.65	17.5	○*									
340	380	18	○			○						
	380	20	○	○			○					
	380	25	○									
	384	20	○									
	390	20	○									
	390	25							○			
	400	25	○	○		○			○			
	400	28							○			

YS type

d_1 342.9~(410)

YS YSN YSA YSAN

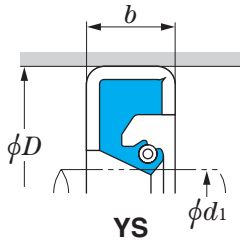

YSN



YSA



YSAN

Remarks

- 1) For seals marked ○, JTEKT owns molding dies for production.
- 2) Seal number is constructed by combination of type code and dimensional numbers (bore diameter, outside diameter and width).
Example: YS32036018 (320×360×18 mm).
- 3) Seal number marked ○* have suffix -1.
- 4) Seals with spacers are available.
Seal number with spacers is referred on right side page.
- 5) Rubber code N represents nitrile rubber, F: fluorocarbon rubber, and K: hydrogenated nitrile rubber.

d_1 342.9~(380)

Boundary dimensions, mm			Seal type											
d_1	D	b	YS			YSN			YSA		YSAN			
			N	F	K	N	F	K	N	F	N	F		
342.9	381	17.5	○											
	393.7	20.6	○											
	393.7	25.4	○											
350	390	16				○								
	390	18	○											
	390	20	○											
	400	17	○											
	400	25	○							○				
	410	25	○											
	410	28								○	○			
355	405	25	○							○				
	415	28								○				
355.6	406.4	20.6	○*											
	406.4	25.4	○											
360	400	17	○			○								
	400	18	○			○								
	400	20	○											
	400	25	○											
	410	25	○							○				
	420	25	○							○				
	420	28								○	○			
365	405	18	○											
370	410	18	○	○										
	410	20	○											
	410	25	○											
	415	20	○	○										
	420	20	○											
	420	25	○							○				
	430	25	○											
	430	28								○				
374.65	419.1	22.2	○											
375	420	18	○											
	420	20	○											
	435	28								○				
380	420	18	○											

Example of seal number with spacer

Example 1 **YS 320 360 18 D5**
 Spacer width: 5 mm

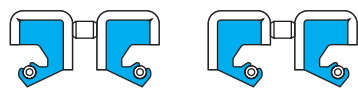
Example 2 **YS 320 360 18 2D5**
 Spacer width: 5 mm

Various width spacers are available as like 10 mm.

d_1 (380)~(410)

Boundary dimensions, mm			Seal type									
d_1	D	b	YS			YSN			YSA		YSAN	
			N	F	K	N	F	K	N	F	N	F
380	420	20	○									
	420	25	○									
	430	25	○									
	440	25	○									
	440	28							○			
381	419.1	17.5	○									
	431.8	20.6	○*									
	431.8	25.4	○									
385	425	18	○									
387.4	425.15	17.5	○*									
390	430	18	○									
	430	20	○									
	440	20	○									
	440	25	○						○			
	450	25	○						○			
	450	28							○			
393.7	431.8	19	○									
400	440	18	○			○						
	440	20	○									
	444	20	○									
	450	20	○									
	450	25	○						○			
	460	25	○						○			
	460	28							○			
400.05	438.15	15				○						
	438.15	17.5	○			○						
405	455	25	○									
406.4	444.5	19	○									
	450.85	22.2	○						○*			
	457.2	20.6	○			○						
	457.2	23	○			○						
	457.2	23.8	○*									
410	450	20	○									
	460	25	○						○			
	470	25	○									

YS type

d_1 (410)~(500)

YS YSN YSA YSAN

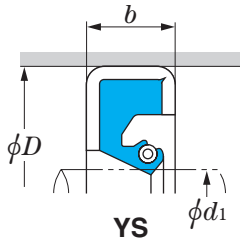

YSN



YSA



YSAN

Remarks

- 1) For seals marked ○, JTEKT owns molding dies for production.
- 2) Seal number is constructed by combination of type code and dimensional numbers (bore diameter, outside diameter and width).
Example: YS32036018 (320×360×18 mm).
- 3) Seal number marked ○* have suffix -1.
- 4) Seals with spacers are available.
Seal number with spacers is referred on right side page.
- 5) Rubber code N represents nitrile rubber, F: fluorocarbon rubber, and K: hydrogenated nitrile rubber.

d_1 (410)~(450)

Boundary dimensions, mm			Seal type										
d_1	D	b	YS			YSN			YSA		YSAN		
			N	F	K	N	F	K	N	F	N	F	
410	470	28									○		
	480	25	○										
415	475	23	○										
419.1	457.2	19.1	○										
420	460	18	○										
	460	19	○										
	460	20	○					○					
	460	25	○										
	470	20	○										
	470	22	○*					○					
	470	25	○	○							○		
	480	25	○								○		
	480	28									○		
	425	465	20	○								○	
485		28									○		
430	470	20	○					○					
	480	20	○										
	480	25	○								○		
	490	25	○					○					
	490	28									○		
431.8	469.9	19	○										
432	476	20	○										
438.2	476.25	19	○										
440	480	20	○					○					
	490	17	○										
	490	20	○										
	490	22	○*										
	490	25	○										
	500	25	○										
	500	28									○		
	444.5	495.3	25.4	○									
450	490	19	○										
	490	20	○										
	500	20	○					○					
	500	25	○								○		

Example of seal number with spacer

Example 1 **YS 320 360 18 D5**
 Spacer width: 5 mm

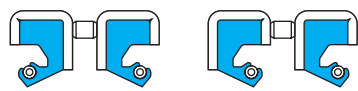
Example 2 **YS 320 360 18 2D5**
 Spacer width: 5 mm

Various width spacers are available as like 10 mm.

d_1 (450)~(500)

Boundary dimensions, mm			Seal type									
d_1	D	b	YS			YSN			YSA		YSAN	
			N	F	K	N	F	K	N	F	N	F
450	510	25	○	○		○						
	510	28							○			
452.6	501.65	19.1	○*									
454	504.82	19	○									
457.2	508	19.1	○									
460	500	20	○			○						
	510	20	○									
	510	25	○									
	520	25	○	○		○			○			
	520	28							○			
463.6	501.65	19.1	○									
465	510	20	○									
	515	25							○			
467	510	20	○									
469.9	520.7	23	○									
	520.7	23.4	○									
470	510	20	○									
	520	18	○*									
	520	20	○			○	○					
	520	25							○			
	530	25	○						○			
	530	28							○			
480	520	20	○			○						
	530	18				○						
	530	20	○									
	530	22	○									
	530	25	○									
	540	25	○	○					○			
	540	28							○			
482.6	520.7	19	○	○								
490	530	20	○									
	540	25	○						○			
	550	25	○									
495.3	546.1	23.8	○									
500	540	20	○			○						

YS type

d_1 (500)~(600)

YS YSN YSA YSAN

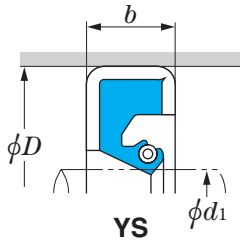

YSN



YSA



YSAN

Remarks

- 1) For seals marked \bigcirc , JTEKT owns molding dies for production.
- 2) Seal number is constructed by combination of type code and dimensional numbers (bore diameter, outside diameter and width).
Example: YS32036018 (320×360×18 mm).
- 3) Seal number marked $\bigcirc*$ have suffix -1.
- 4) Seals with spacers are available.
Seal number with spacers is referred on right side page.
- 5) Rubber code N represents nitrile rubber, F: fluorocarbon rubber, and K: hydrogenated nitrile rubber.

d_1 (500)~(550)

Boundary dimensions, mm			Seal type												
d_1	D	b	YS			YSN			YSA		YSAN				
			N	F	K	N	F	K	N	F	N	F			
500	550	20	\bigcirc												
	550	25	\bigcirc												
	560	25	\bigcirc							\bigcirc					
	560	28								\bigcirc					
510	550	20	\bigcirc												
	560	25	\bigcirc	\bigcirc		\bigcirc									
	570	28								\bigcirc					
514	565	25	\bigcirc												
514.4	565.15	22.2	\bigcirc												
520	560	20	\bigcirc	\bigcirc				\bigcirc							
	570	20	\bigcirc												
	580	25	\bigcirc							\bigcirc					
	580	28								\bigcirc					
520.7	558.8	19.1	$\bigcirc*$												
	571.5	22.2	\bigcirc												
530	570	20	\bigcirc												
	580	20	\bigcirc												
	580	22	\bigcirc												
	590	28								\bigcirc					
	600	25	\bigcirc												
539.8	590.55	22	$\bigcirc*$												
540	580	20	\bigcirc												
	580	25	\bigcirc												
	590	20	\bigcirc												
	590	25	\bigcirc												
	600	24										\bigcirc			
	600	25	\bigcirc							\bigcirc					
	600	28								\bigcirc					
610	25	\bigcirc													
546.1	596.9	20.6	\bigcirc												
	596.9	22.2	\bigcirc												
550	590	20	\bigcirc												
	600	20	\bigcirc												
	600	25	\bigcirc	\bigcirc											
	610	23	\bigcirc												

Example of seal number with spacer

Example 1 **YS 320 360 18 D5**
 Spacer width: 5 mm

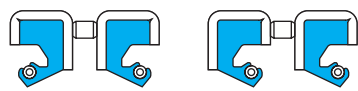
Example 2 **YS 320 360 18 2D5**
 Spacer width: 5 mm

Various width spacers are available as like 10 mm.

d_1 (550)~(600)

Boundary dimensions, mm			Seal type									
d_1	D	b	YS			YSN			YSA		YSAN	
			N	F	K	N	F	K	N	F	N	F
550	610	25	○									
	610	28							○			
	620	25	○	○								
558	618	25	○									
	558.8	596.9	19.1	○*								
		609.6	22.2	○								
	622.3	22.2	○									
560	600	20	○									
	610	20	○			○						
	610	22	○									
	610	23	○									
	620	18				○						
	620	25	○									
	620	28							○			
	620	30							○			
	630	25	○	○								
570	610	20	○									
	620	22	○									
	630	25	○									
579.2	630	25.4	○									
580	620	20	○			○						
	630	20	○									
	630	25	○									
	640	25	○									
	640	28							○			
	640	30							○			
584.2	622.3	19	○		○							
	635	25.4	○									
587	637	20	○									
590	630	20	○									
	640	20	○									
	640	25	○									
	650	28							○			
600	640	19	○									
	640	20	○									

YS type

d_1 (600)~(740)

YS YSN YSA YSAN

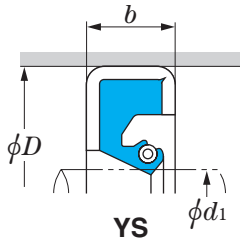

YSN



YSA



YSAN

Remarks

- 1) For seals marked ○, JTEKT owns molding dies for production.
- 2) Seal number is constructed by combination of type code and dimensional numbers (bore diameter, outside diameter and width).
Example: YS32036018 (320×360×18 mm).
- 3) Seal number marked ○* have suffix -1.
- 4) Seals with spacers are available.
Seal number with spacers is referred on right side page.
- 5) Rubber code N represents nitrile rubber, F: fluorocarbon rubber, and K: hydrogenated nitrile rubber.

d_1 (600)~(660)

Boundary dimensions, mm			Seal type										
d_1	D	b	YS			YSN			YSA		YSAN		
			N	F	K	N	F	K	N	F	N	F	
600	650	25									○		
	660	25	○										
	660	28									○		
609.6	660.4	22.2	○										
610	660	25	○										
	670	23	○										
	670	25	○										
	670	28									○		
	670	30									○		
620	660	20	○										
	670	20	○										
	670	25	○										
	680	25	○										
	680	28									○		
	690	25	○										
630	670	20	○										
	670	25	○										
	680	25	○										
	690	25	○										
	690	30	○										
	700	30									○		
635	673.1	19.1	○										
	685	25	○										
	695	25	○										
640	680	20	○										
	690	25	○										
	700	25	○										
	700	28									○		
647.7	698.5	22.2	○										
650	700	25	○										
	710	25	○										
	710	28									○		
	710	30											
	720	25	○										
660	710	25	○										

Example of seal number with spacer

Example 1 **YS 320 360 18 D5**  Spacer width: 5 mm

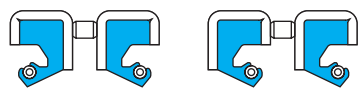
Example 2 **YS 320 360 18 2D5**  Spacer width: 5 mm

Various width spacers are available as like 10 mm.

d_1 (660)~(740)

Boundary dimensions, mm			Seal type									
d_1	D	b	YS			YSN			YSA		YSAN	
			N	F	K	N	F	K	N	F	N	F
660	720	25	○									
660.4	711.2	22.2	○									
670	710	20	○									
	720	20	○									
	720	25	○									
	734	22				○						
673.1	711.2	19	○									
676	740	20				○						
680	720	20	○									
	730	25	○									
685	745	25	○									
685.8	736.6	20.2	○									
	736.6	22.2	○*									
690	730	20	○									
	750	25	○									
698.5	749.3	22.2	○									
700	750	20	○									
	750	25	○									
	760	25	○									
710	750	20	○									
	760	25	○									
	770	25	○	○		○						
711.2	762	22.2	○									
720	770	25	○									
	780	28							○			
	780	30				○						
723.9	774.7	22.2	○*									
730	780	25	○									
	790	25	○									
730.3	781.05	22.2	○									
735	795	25	○									
736.6	774.7	19	○									
	787.4	22.2	○*									
	812.8	41.3							○			
740	790	25	○									

YS type

d_1 (740)~(970)

YS YSN YSA YSAN

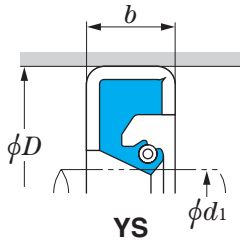

YSN



YSA



YSAN

Remarks

- 1) For seals marked ○, JTEKT owns molding dies for production.
- 2) Seal number is constructed by combination of type code and dimensional numbers (bore diameter, outside diameter and width).
Example: YS32036018 (320×360×18 mm).
- 3) Seal number marked ○* have suffix -1.
- 4) Seals with spacers are available.
Seal number with spacers is referred on right side page.
- 5) Rubber code N represents nitrile rubber, F: fluorocarbon rubber, and K: hydrogenated nitrile rubber.

d_1 (740)~(850)

Boundary dimensions, mm			Seal type											
d_1	D	b	YS			YSN			YSA		YSAN			
			N	F	K	N	F	K	N	F	N	F		
740	800	25	○											
750	800	25	○											
	810	25	○											
	810	28								○				
760	810	25	○											
	813	22				○			○					
	820	25	○											
762	825.5	22.4	○											
774.7	825.5	22.2	○											
	850.9	25.4	○											
780	830	25	○		○									
790	835	20				○								
	840	25	○											
	850	25	○*											
793.5	844.55	19	○											
800	850	22	○											
	850	25	○		○									
	860	25	○											
	870	25	○											
	810	860	25	○										
810	870	25	○											
	870	28								○				
	874	22	○											
	820	870	25	○										
820	880	25	○											
	880	28								○				
	825.5	876.3	22.2	○										
830	880	25	○											
	900	25	○											
838.2	879.5	19				○								
	889	22.2	○											
840	890	25	○		○									
	910	25	○											
849	900	25										○		
850	900	25	○	○										○

Example of seal number with spacer

Example 1 **YS 320 360 18 D5**  Spacer width: 5 mm

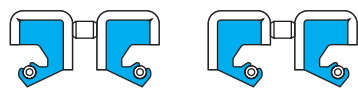
Example 2 **YS 320 360 18 2D5**  Spacer width: 5 mm

Various width spacers are available as like 10 mm.

d_1 (850)~(970)

Boundary dimensions, mm			Seal type									
d_1	D	b	YS			YSN			YSA		YSAN	
			N	F	K	N	F	K	N	F	N	F
850	910	25	○									
850.9	914.4	22.2	○									
860	910	25	○									
	920	23	○									
864	928	22	○									
870	920	25	○			○		○				
876.3	927.1	22.2	○									
880	930	25	○									
	930	30							○			
	940	25	○									
	940	28							○			
882.7	933.45	22.2	○									
889	939.8	20.6	○									
	952.5	22.2	○									
	952.5	25.4	○									
	965.2	25.4	○									
890	940	25	○									
	950	25	○									
900	950	25	○				○		○			
	960	25	○									
914.4	977.9	25.4	○									
920	970	20	○									
	970	25	○									
927.1	977.9	22.2	○									
940	990	25	○									
	1 000	25	○									
950	1 000	23	○									
	1 000	25	○									
	1 000	30								○		
	1 010	25	○									
952.5	990.6	22.2				○						
	1 002.9	22.2	○									
	1 003.3	22.2	○									
960	1 020	25	○									
970	1 020	25	○									

YS type

d_1 (970)~1 640

YS YSN YSA YSAN

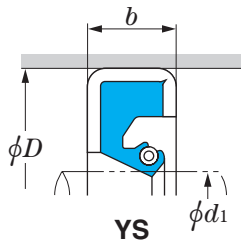

YSN



YSA



YSAN

Remarks

- 1) For seals marked ○, JTEKT owns molding dies for production.
- 2) Seal number is constructed by combination of type code and dimensional numbers (bore diameter, outside diameter and width).
Example: YS32036018 (320×360×18 mm).
- 3) Seal number marked ○* have suffix -1.
- 4) Seals with spacers are available.
Seal number with spacers is referred on right side page.
- 5) Rubber code N represents nitrile rubber, F: fluorocarbon rubber, and K: hydrogenated nitrile rubber.

d_1 (970)~(1 320)

Boundary dimensions, mm			Seal type									
d_1	D	b	YS			YSN			YSA		YSAN	
			N	F	K	N	F	K	N	F	N	F
970	1 030	25	○*									
971.5	1 035.05	19.05	○									
971.6	1 035.05	25	○									
977.9	1 041.4	25	○*									
990	1 040	25	○*									
990.6	1 041.4	22.2	○									
1 000	1 050	22	○									
	1 050	23	○		○							
	1 050	25	○									
	1 050	30							○			
	1 060	25	○									
	1 100	20						○				
1 010	1 060	25			○							
1 016	1 066.8	22.2	○									
1 020	1 070	25	○									
1 030	1 070	25	○									
1 050	1 110	25	○									
1 070	1 120	25	○									
	1 130	25	○									
1 079.5	1 143	22.2	○									
1 080	1 130	25	○*									
1 090	1 140	25	○									
	1 150	25	○									
1 092.2	1 155.7	25.4	○									
1 104.9	1 155.7	22.2	○									
1 105	1 155	15						○				
1 110	1 160	25	○									
1 117.6	1 181.1	22.2	○									
1 130	1 180	25	○									
1 136	1 186	25	○									
1 140	1 200	25	○									
1 180	1 260	30	○									
1 200	1 264	25	○									
1 210	1 270	25	○									
1 320	1 380	30							○	○		

Example of seal number with spacer

Example 1 **YS 320 360 18 D5**
 Spacer width: 5 mm

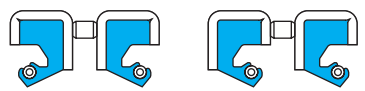
Example 2 **YS 320 360 18 2D5**
 Spacer width: 5 mm

Various width spacers are available as like 10 mm.

d_1 (1 320)~1 640

Boundary dimensions, mm			Seal type									
d_1	D	b	YS			YSN			YSA		YSAN	
			N	F	K	N	F	K	N	F	N	F
1 320	1 420	30	○									
1 340	1 390	25	○									
1 360	1 410	25	○									
1 400	1 460	25	○									
	1 500	30	○									
1 460	1 510	25	○									
1 480	1 530.8	22.2	○									
1 498.6	1 549.4	22.2	○						○			
1 500	1 550	25	○									
1 640	1 690	25	○*									

Assembled seals

d_1 115~440

HMSH

Seals with reinforcing inner metal ring

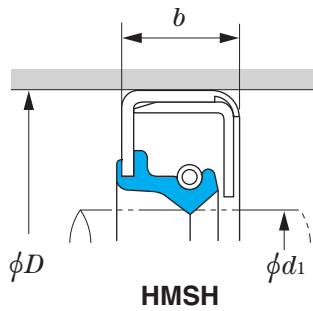

Remark) All seals use nitrile rubber.

d_1 115~(190)

Boundary dimensions, mm			Seal No.
d_1	D	b	
115	145	14	HMSH 115 145 14
120	150	14	HMSH 120 150 14
125	155	14	HMSH 125 155 14
130	150	10	HMSH 130 150 10
	160	14	HMSH 130 160 14
	170	16	HMSH 130 170 16
135	165	14	HMSH 135 165 14
140	170	14	HMSH 140 170 14
150	180	14	HMSH 150 180 14
155	190	14	HMSH 155 190 14
160	190	14	HMSH 160 190 14
	190	16	HMSH 160 190 16
	210	20	HMSH 160 210 20
165	195	14	HMSH 165 195 14
	200	15	HMSH 165 200 15
	220	20	HMSH 165 220 20
170	200	16	HMSH 170 200 16
	205	16	HMSH 170 205 16
	225	20	HMSH 170 225 20
175	220	15	HMSH 175 220 15
	230	20	HMSH 175 230 20
180	210	14	HMSH 180 210 14
	210	15	HMSH 180 210 15
	210	16	HMSH 180 210 16
	215	16	HMSH 180 215 16
	215	18	HMSH 180 215 18
	220	15	HMSH 180 220 15
	220	18	HMSH 180 220 18
	225	16	HMSH 180 225 16
225	18	HMSH 180 225 18	
180	235	20	HMSH 180 235 20
	240	22	HMSH 180 240 22
190	220	12	HMSH 190 220 12
	220	14	HMSH 190 220 14
	220	15	HMSH 190 220 15
	225	14	HMSH 190 225 14
	225	16	HMSH 190 225 16
	225	18	HMSH 190 225 18
	245	20	HMSH 190 245 20

d_1 (190)~(220)

Boundary dimensions, mm			Seal No.	
d_1	D	b		
190	245	22	HMSH 190 245 22	
	245	25	HMSH 190 245 25	
195	230	16	HMSH 195 230 16	
	250	20	HMSH 195 250 20	
	250	22	HMSH 195 250 22	
198	255	22	HMSH 198 255 22	
200	230	15	HMSH 200 230 15	
	230	16	HMSH 200 230 16	
	230	18	HMSH 200 230 18	
	235	16	HMSH 200 235 16	
	235	18	HMSH 200 235 18	
	240	14	HMSH 200 240 14	
200	240	20	HMSH 200 240 20	
	250	15	HMSH 200 250 15	
	205	230	16	HMSH 205 230 16
		235	15	HMSH 205 235 15
		235	16	HMSH 205 235 16
205	260	23	HMSH 205 260 23	
	210	240	12	HMSH 210 240 12
		240	15	HMSH 210 240 15
250		16	HMSH 210 250 16	
210	250	18	HMSH 210 250 18	
	265	23	HMSH 210 265 23	
	212	245	16	HMSH 212 245 16
215	240	12	HMSH 215 240 12	
	245	14	HMSH 215 245 14	
	245	15	HMSH 215 245 15	
	250	16	HMSH 215 250 16	
	255	16	HMSH 215 255 16	
	270	23	HMSH 215 270 23	
	220	240	20	HMSH 220 240 20
245		14	HMSH 220 245 14	
250		15	HMSH 220 250 15	
250		16	HMSH 220 250 16	
255		16	HMSH 220 255 16	
255		22	HMSH 220 255 22	
220	260	12	HMSH 220 260 12	
	260	15	HMSH 220 260 15	
	260	16	HMSH 220 260 16	

d_1 (220)~(280)

Boundary dimensions, mm			Seal No.
d_1	D	b	
220	275	23	HMSH 220 275 23
224	260	18	HMSH 224 260 18
225	255	13	HMSH 225 255 13
	255	18	HMSH 225 255 18
	280	23	HMSH 225 280 23
230	255	15	HMSH 230 255 15
	255	16	HMSH 230 255 16
	260	15	HMSH 230 260 15
	260	20	HMSH 230 260 20
	260	22	HMSH 230 260 22
	268	19	HMSH 230 268 19
	280	20	HMSH 230 280 20
	280	23	HMSH 230 280 23
	285	23	HMSH 230 285 23
	285	25	HMSH 230 285 25
235	290	23	HMSH 235 290 23
236	270	16	HMSH 236 270 16
240	270	15	HMSH 240 270 15
	270	16	HMSH 240 270 16
	275	18	HMSH 240 275 18
	280	19	HMSH 240 280 19
300	25	HMSH 240 300 25	
245	275	13	HMSH 245 275 13
	305	25	HMSH 245 305 25
	305	28	HMSH 245 305 28
250	280	15	HMSH 250 280 15
	280	18	HMSH 250 280 18
	285	16	HMSH 250 285 16
	290	16	HMSH 250 290 16
	310	25	HMSH 250 310 25
254	286	15	HMSH 254 286 15
260	280	16	HMSH 260 280 16
	290	16	HMSH 260 290 16
	300	18	HMSH 260 300 18
	300	20	HMSH 260 300 20
	300	22	HMSH 260 300 22
	320	25	HMSH 260 320 25
265	290	16	HMSH 265 290 16
	300	15	HMSH 265 300 15
	300	18	HMSH 265 300 18
	305	18	HMSH 265 305 18
	325	25	HMSH 265 325 25
270	300	15	HMSH 270 300 15
	310	18	HMSH 270 310 18
	313	20	HMSH 270 313 20
	330	25	HMSH 270 330 25
	330	28	HMSH 270 330 28
275	310	16	HMSH 275 310 16
280	305	12	HMSH 280 305 12
	310	16	HMSH 280 310 16

d_1 (280)~440

Boundary dimensions, mm			Seal No.	
d_1	D	b		
280	310	18	HMSH 280 310 18	
	320	18	HMSH 280 320 18	
	320	20	HMSH 280 320 20	
	330	25	HMSH 280 330 25	
	290	320	25	HMSH 290 320 25
		330	18	HMSH 290 330 18
350		25	HMSH 290 350 25	
298	337	20	HMSH 298 337 20	
300	330	15	HMSH 300 330 15	
	332	16	HMSH 300 332 16	
	335	18	HMSH 300 335 18	
	340	16	HMSH 300 340 16	
	340	18	HMSH 300 340 18	
	340	20	HMSH 300 340 20	
	340	22	HMSH 300 340 22	
	345	22	HMSH 300 345 22	
	360	20	HMSH 300 360 20	
	360	25	HMSH 300 360 25	
		372	16	HMSH 300 372 16
	310	340	15	HMSH 310 340 15
340		22	HMSH 310 340 22	
350		18	HMSH 310 350 18	
320	360	18	HMSH 320 360 18	
	380	25	HMSH 320 380 25	
330	360	18	HMSH 330 360 18	
	370	18	HMSH 330 370 18	
	380	18	HMSH 330 380 18	
	390	25	HMSH 330 390 25	
	390	28	HMSH 330 390 28	
340	372	16	HMSH 340 372 16	
	380	16	HMSH 340 380 16	
	380	18	HMSH 340 380 18	
350	390	18	HMSH 350 390 18	
355	390	15	HMSH 355 390 15	
370	410	15	HMSH 370 410 15	
	410	18	HMSH 370 410 18	
375	420	18	HMSH 375 420 18	
380	440	25	HMSH 380 440 25	
420	480	25	HMSH 420 480 25	
440	490	16.5	HMSH 440 490 16.5	

Assembled seals d_1 117~405**HMSH...J**

Seals with reinforcing inner metal ring

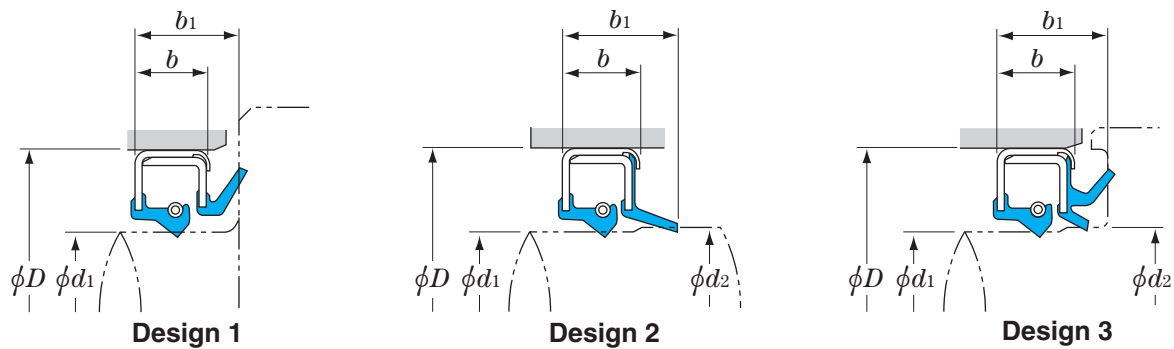

Remarks 1) All seals use nitrile rubber.

2) Consult JTEKT for drain-provided seals.

 d_1 117~254

Boundary dimensions, mm					Seal No.	Design
d_1	d_2	D	b	b_1		
117	—	140	10	14	HMSH 117 140 10 – 14 J	1
129	—	150	10	15	HMSH 129 150 10 – 15 J	1
130	132	150	10	14	HMSH 130 150 10 – 14 J	3
134	—	160	11	17	HMSH 134 160 11 – 17 J	1
137	139	160	11	14	HMSH 137 160 11 – 14 J	3
145	—	165	10	15	HMSH 145 165 10 – 15 J	1
155	158	180	13	17	HMSH 155 180 13 – 17 J	3
159	—	183	12	18	HMSH 159 183 12 – 18 J	1
166	—	190	12	18	HMSH 166 190 12 – 18 J	1
170	—	200	16	25	HMSH 170 200 16 – 25 J	1
174	177	200	14	19	HMSH 174 200 14 – 19 J	3
175	—	200	10	15.5	HMSH 175 200 10 – 15.5 J	1
180	—	220	16	25	HMSH 180 220 16 – 25 J	1
190	—	220	12	18	HMSH 190 220 12 – 18 J	1
	193	220	14	20	HMSH 190 220 14 – 20 J	3
200	203	230	14	20	HMSH 200 230 14 – 20 J	3
	—	235	16	23	HMSH 200 235 16 – 23 J	1
205	—	235	13	19	HMSH 205 235 13 – 19 J	1
	—	235	15	22	HMSH 205 235 15 – 22 J	1
210	—	240	12	21	HMSH 210 240 12 – 21 J	1
215	—	240	12	18	HMSH 215 240 12 – 18 J	1
	—	245	13	19	HMSH 215 245 13 – 19 J	1
	218	245	14	22	HMSH 215 245 14 – 22 J	3
220	—	245	13	21	HMSH 220 245 13 – 21 J	1
	—	260	16	23	HMSH 220 260 16 – 23 J	1
225	—	255	13	21	HMSH 225 255 13 – 21 J	1
	228	260	14	20	HMSH 225 260 14 – 20 J	3
230	—	260	15	23	HMSH 230 260 15 – 23 J	1
240	240	270	16	22	HMSH 240 270 16 – 22 J	2
	—	270	16	23	HMSH 240 270 16 – 23 J	1
	243	275	16	24	HMSH 240 275 16 – 24 J	3
245	—	275	13	21	HMSH 245 275 13 – 21 J	1
250	—	280	16	23	HMSH 250 280 16 – 23 J	1
	—	280	16	25	HMSH 250 280 16 – 25 J	1
254	—	285	11.5	18.4	HMSH 254 285 11.5 – 18.4 J	1

d_1 260~405

Boundary dimensions, mm					Seal No.	Design
d_1	d_2	D	b	b_1		
260	263	290	14	20	HMSH 260 290 14 – 20 J	3
270	—	300	16	25	HMSH 270 300 16 – 25 J	1
280	—	316	18	25	HMSH 280 316 18 – 25 J	1
	—	320	20	27	HMSH 280 320 20 – 27 J	1
	384	320	20	28	HMSH 280 320 20 – 28 J	3
290	—	330	18	28	HMSH 290 330 18 – 28 J	1
300	300	340	20	29	HMSH 300 340 20 – 29 J	3
310	—	350	18	28	HMSH 310 350 18 – 28 J	1
	313	350	20	28	HMSH 310 350 20 – 28 J	3
320	—	360	18	25	HMSH 320 360 18 – 25 J	1
330	—	380	18	25	HMSH 330 380 18 – 25 J	1
340	—	380	18	24	HMSH 340 380 18 – 24 J	1
	—	380	16	21.5	HMSH 340 380 16 – 21.5 J	1
	343	380	18	26	HMSH 340 380 18 – 26 J	3
350	—	390	18	25	HMSH 350 390 18 – 25 J	1
370	—	410	18	25	HMSH 370 410 18 – 25 J	1
375	378	420	20	28	HMSH 375 420 20 – 28 J	3
405	—	435	14.5	19.2	HMSH 405 435 14.5 – 19.2 J	1

Full rubber seals

d_1 10~238

MS

■ Mounting example

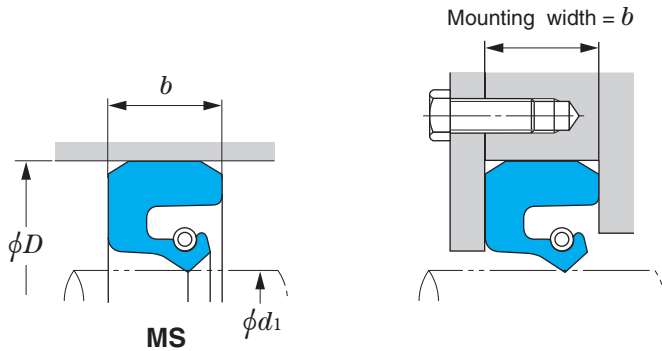

Remarks

- 1) All seals use nitrile rubber.
- 2) Mounting width deviation should be as specified in the table below:

Mounting width deviation (Unit : mm)

Mounting width = b	Deviation
— Up to 6	- 0.1 ~ - 0.2
Over 6 up to 10	- 0.1 ~ - 0.3
Over 10 up to 18	- 0.1 ~ - 0.4
Over 18 up to 30	- 0.1 ~ - 0.5

d_1 10~70

Boundary dimensions, mm			Seal No.
d_1	D	b	
10	26	6	MS 10 26 6
20	44	12	MS 20 44 12
25	49	12	MS 25 49 12
30	45	8	MS 30 45 8
	54	12	MS 30 54 12
35	59	12	MS 35 59 12
	60	12	MS 35 60 12
38	60	12	MS 38 60 12
40	62	12	MS 40 62 12
	65	12	MS 40 65 12
	67	14	MS 40 67 14
42	66	12	MS 42 66 12
	72	14	MS 45 72 14
50	72	12	MS 50 72 12
	75	13	MS 50 75 13
	77	14	MS 50 77 14
	80	14	MS 50 80 14
	55	78	12
82		14	MS 55 82 14
85		14	MS 55 85 14
60	80	10	MS 60 80 10
	82	12	MS 60 82 12
	82	13	MS 60 82 13
	84	13	MS 60 84 13
	87	14	MS 60 87 14
	90	14	MS 60 90 14
65	90	13	MS 65 90 13
	90	14	MS 65 90 14
	92	14	MS 65 92 14
	95	14	MS 65 95 14
	95	15	MS 65 95 15
70	95	16	MS 65 95 16
	86	9	MS 70 86 9
	92	12	MS 70 92 12
100	16	MS 70 100 16	

d_1 75~(120)

Boundary dimensions, mm			Seal No.	
d_1	D	b		
75	100	13	MS 75 100 13	
	100	16	MS 75 100 16	
	105	16	MS 75 105 16	
80	105	13	MS 80 105 13	
	110	16	MS 80 110 16	
85	110	13	MS 85 110 13	
	115	16	MS 85 115 16	
90	115	13	MS 90 115 13	
	120	16	MS 90 120 16	
95	120	10	MS 95 120 10	
	120	13	MS 95 120 13	
	125	16	MS 95 125 16	
	100	120	13	MS 100 120 13
100	130	16	MS 100 130 16	
	130	18	MS 100 130 18	
	133	18	MS 100 133 18	
	135	15	MS 100 135 15	
	104	149	12	MS 104 149 12
105	140	13	MS 105 140 13	
	140	15	MS 105 140 15	
	140	18	MS 105 140 18	
108	134	16	MS 108 134 16	
110	135	8	MS 110 135 8	
	140	12	MS 110 140 12	
	140	14	MS 110 140 14	
	143	18	MS 110 143 18	
	145	18	MS 110 145 18	
	115	145	18	MS 115 145 18
115	148	18	MS 115 148 18	
	150	18	MS 115 150 18	
	120	150	14	MS 120 150 14
	150	15	MS 120 150 15	
120	150	18	MS 120 150 18	
	153	18	MS 120 153 18	
	155	16	MS 120 155 16	

d_1 (120)~(180)

Boundary dimensions, mm			Seal No.
d_1	D	b	
120	155	18	MS 120 155 18
125	155	14	MS 125 155 14
	158	18	MS 125 158 18
	160	18	MS 125 160 18
130	160	14	MS 130 160 14
	163	18	MS 130 163 18
	165	18	MS 130 165 18
135	168	18	MS 135 168 18
	170	18	MS 135 170 18
	175	18	MS 135 175 18
140	170	14	MS 140 170 14
	173	18	MS 140 173 18
	175	18	MS 140 175 18
	177	16	MS 140 177 16
145	175	14	MS 145 175 14
	178	18	MS 145 178 18
	180	18	MS 145 180 18
150	180	14	MS 150 180 14
	185	18	MS 150 185 18
	186	20	MS 150 186 20
	186	26	MS 150 186 26
	190	16	MS 150 190 16
155	191	20	MS 155 191 20
	200	20	MS 155 200 20
160	195	18	MS 160 195 18
	196	20	MS 160 196 20
165	201	20	MS 165 201 20
168	205	20	MS 168 205 20
170	203	13	MS 170 203 13
	205	16	MS 170 205 16
	206	20	MS 170 206 20
	210	20	MS 170 210 20
	225	20	MS 170 225 20
175	211	20	MS 175 211 20
180	216	20	MS 180 216 20

d_1 (180)~238

Boundary dimensions, mm			Seal No.
d_1	D	b	
180	220	20	MS 180 220 20
185	221	20	MS 185 221 20
188	230	20	MS 188 230 20
190	220	12	MS 190 220 12
	220	20	MS 190 220 20
	226	20	MS 190 226 20
	230	20	MS 190 230 20
193	233	16	MS 193 233 16
195	230	19	MS 195 230 19
	231	20	MS 195 231 20
200	230	16	MS 200 230 16
	239	22	MS 200 239 22
	240	20	MS 200 240 20
	240	22	MS 200 240 22
203	250	20	MS 203 250 20
205	250	20	MS 205 250 20
208	248	16	MS 208 248 16
	250	20	MS 208 250 20
210	249	22	MS 210 249 22
215	254	20	MS 215 254 20
	254	22	MS 215 254 22
220	260	20	MS 220 260 20
	260	22	MS 220 260 22
224	260	16	MS 224 260 16
225	260	18	MS 225 260 18
	265	20	MS 225 265 20
230	260	20	MS 230 260 20
	261	10	MS 230 261 10
	269	22	MS 230 269 22
	270	20	MS 230 270 20
	285	23	MS 230 285 23
231	270	20	MS 231 270 20
235	275	20	MS 235 275 20
	275	22	MS 235 275 22
238	275	20	MS 238 275 20

Full rubber seals

d_1 240~810

MS

■ Mounting example

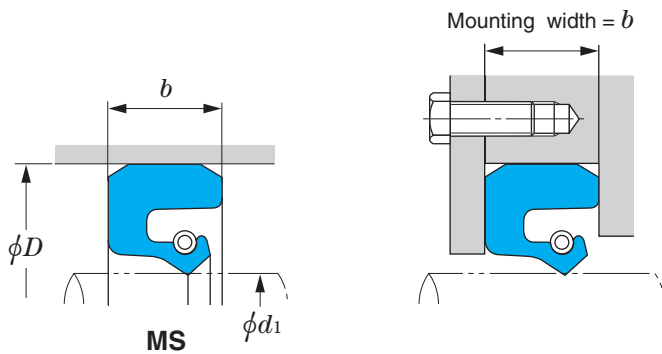

Remarks

- 1) All seals use nitrile rubber.
- 2) Mounting width deviation should be as specified in the table below:

Mounting width = b		Deviation
—	Up to 6	- 0.1 ~ - 0.2
Over 6	up to 10	- 0.1 ~ - 0.3
Over 10	up to 18	- 0.1 ~ - 0.4
Over 18	up to 30	- 0.1 ~ - 0.5

d_1 240~(320)

Boundary dimensions, mm			Seal No.
d_1	D	b	
240	275	16	MS 240 275 16
	280	20	MS 240 280 20
	280	22	MS 240 280 22
245	290	20	MS 245 290 20
250	290	20	MS 250 290 20
	290	24	MS 250 290 24
	295	24	MS 250 295 24
255	300	24	MS 255 300 24
	310	24	MS 255 310 24
260	305	22	MS 260 305 22
	315	24	MS 260 315 24
265	310	22	MS 265 310 22
	315	24	MS 265 315 24
270	320	24	MS 270 320 24
275	320	20	MS 275 320 20
	320	24	MS 275 320 24
280	315	20	MS 280 315 20
	325	22	MS 280 325 22
	325	24	MS 280 325 24
	340	25	MS 280 340 25
290	335	24	MS 290 335 24
	350	25	MS 290 350 25
300	340	20	MS 300 340 20
	344	20	MS 300 344 20
	345	22	MS 300 345 22
	345	25	MS 300 345 25
	350	25	MS 300 350 25
310	350	20	MS 310 350 20
	355	24	MS 310 355 24
	355	25	MS 310 355 25
	360	25	MS 310 360 25
315	360	20	MS 315 360 20
	360	25	MS 315 360 25
320	370	20	MS 320 370 20
	370	25	MS 320 370 25

d_1 (320)~450

Boundary dimensions, mm			Seal No.
d_1	D	b	
320	380	25	MS 320 380 25
	380	27	MS 320 380 27
325	375	25	MS 325 375 25
330	380	24	MS 330 380 24
	380	25	MS 330 380 25
340	384	20	MS 340 384 20
	390	25	MS 340 390 25
	400	25	MS 340 400 25
350	390	25	MS 350 390 25
	400	20	MS 350 400 20
	400	21	MS 350 400 21
355	400	25	MS 350 400 25
	405	25	MS 355 405 25
360	404	20	MS 360 404 20
360	405	25	MS 360 405 25
	405	25	MS 360 405 25
370	420	24	MS 370 420 24
	420	25	MS 370 420 25
	430	25	MS 370 430 25
380	420	20	MS 380 420 20
	428	20	MS 380 428 20
	430	25	MS 380 430 25
	440	25	MS 380 440 25
384	428	20	MS 384 428 20
390	435	25	MS 390 435 25
	450	25	MS 390 450 25
400	450	25	MS 400 450 25
410	460	25	MS 410 460 25
	470	25	MS 410 470 25
420	470	25	MS 420 470 25
	470	30	MS 420 470 30
	480	25	MS 420 480 25
430	480	25	MS 430 480 25
432	476	20	MS 432 476 20
440	490	25	MS 440 490 25
450	500	25	MS 450 500 25

d_1 457~585

Boundary dimensions, mm			Seal No.
d_1	D	b	
457	508	21	MS 457 508 21
460	510	25	MS 460 510 25
	515	28	MS 460 515 28
465	515	25	MS 465 515 25
475	525	25	MS 475 525 25
480	530	30	MS 480 530 30
	540	25	MS 480 540 25
490	540	25	MS 490 540 25
495	545	25	MS 495 545 25
500	550	20	MS 500 550 20
	550	25	MS 500 550 25
	560	25	MS 500 560 25
	560	30	MS 500 560 30
510	560	25	MS 510 560 25
515	565	25	MS 515 565 25
520	570	24	MS 520 570 24
	570	25	MS 520 570 25
	570	30	MS 520 570 30
	580	25	MS 520 580 25
525	575	22	MS 525 575 22
	575	25	MS 525 575 25
540	590	25	MS 540 590 25
	590	30	MS 540 590 30
550	600	25	MS 550 600 25
	600	30	MS 550 600 30
	610	25	MS 550 610 25
560	610	20	MS 560 610 20
	610	30	MS 560 610 30
	620	25	MS 560 620 25
560	620	30	MS 560 620 30
570	620	25	MS 570 620 25
	630	30	MS 570 630 30
580	630	25	MS 580 630 25
	630	30	MS 580 630 30
585	635	22	MS 585 635 22

d_1 600~810

Boundary dimensions, mm			Seal No.
d_1	D	b	
600	647	25	MS 600 647 25
	650	30	MS 600 650 30
	660	25	MS 600 660 25
	670	30	MS 600 670 30
610	660	25	MS 610 660 25
	660	30	MS 610 660 30
	670	30	MS 610 670 30
630	680	25	MS 630 680 25
	680	30	MS 630 680 30
	700	30	MS 630 700 30
635	705	30	MS 635 705 30
650	700	30	MS 650 700 30
	710	30	MS 650 710 30
	720	30	MS 650 720 30
660	740	45	MS 660 740 45
670	720	25	MS 670 720 25
675	725	30	MS 675 725 30
680	730	30	MS 680 730 30
	740	30	MS 680 740 30
690	750	30	MS 690 750 30
695	765	30	MS 695 765 30
700	770	30	MS 700 770 30
710	760	25	MS 710 760 25
	770	30	MS 710 770 30
730	800	30	MS 730 800 30
750	800	30	MS 750 800 30
	810	30	MS 750 810 30
	820	30	MS 750 820 30
770	817	25	MS 770 817 25
	830	30	MS 770 830 30
780	840	30	MS 780 840 30
790	850	30	MS 790 850 30
800	860	30	MS 800 860 30
	870	30	MS 800 870 30
810	857	25	MS 810 857 25

Full rubber seals

 d_1 820~3 530

MS

■ Mounting example

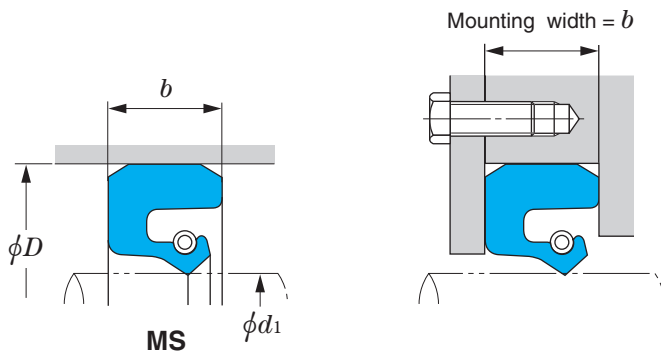

Remarks

- 1) All seals use nitrile rubber.
- 2) Mounting width deviation should be as specified in the table below:

Mounting width deviation (Unit : mm)

Mounting width = b	Deviation
— Up to 6	-0.1 ~ -0.2
Over 6 up to 10	-0.1 ~ -0.3
Over 10 up to 18	-0.1 ~ -0.4
Over 18 up to 30	-0.1 ~ -0.5

 d_1 820~1 550

Boundary dimensions, mm			Seal No.
d_1	D	b	
820	890	30	MS 820 890 30
826	876	30	MS 826 876 30
830	900	30	MS 830 900 30
870	940	30	MS 870 940 30
900	950	25	MS 900 950 25
	960	30	MS 900 960 30
930	1 000	30	MS 930 1000 30
950	1 010	30	MS 950 1010 30
960	1 020	25	MS 960 1020 25
1 000	1 050	30	MS 1000 1050 30
1 005	1 052	25	MS 1005 1052 25
1 030	1 080	30	MS 1030 1080 30
1 040	1 087	25	MS 1040 1087 25
	1 110	30	MS 1040 1110 30
1 045	1 095	25	MS 1045 1095 25
1 090	1 137	25	MS 1090 1137 25
1 100	1 150	30	MS 1100 1150 30
	1 157	25	MS 1100 1157 25
	1 170	30	MS 1100 1170 30
1 110	1 157	25	MS 1110 1157 25
1 170	1 217	25	MS 1170 1217 25
1 200	1 250	24	MS 1200 1250 24
	1 250	30	MS 1200 1250 30
	1 270	30	MS 1200 1270 30
1 210	1 267	25	MS 1210 1267 25
1 220	1 267	25	MS 1220 1267 25
1 310	1 357	25	MS 1310 1357 25
1 390	1 450	30	MS 1390 1450 30
1 400	1 456	25	MS 1400 1456 25
	1 460	30	MS 1400 1460 30
1 450	1 497	25	MS 1450 1497 25
1 470	1 517	25	MS 1470 1517 25
1 526	1 582	25	MS 1526 1582 25
1 530	1 590	30	MS 1530 1590 30
1 550	1 606	25	MS 1550 1606 25

 d_1 1 650~3 530

Boundary dimensions, mm			Seal No.
d_1	D	b	
1 650	1 700	30	MS 1650 1700 30
1 734	1 790	25	MS 1734 1790 25
1 760	1 820	30	MS 1760 1820 30
1 880	1 940	30	MS 1880 1940 30
1 940	1 996	25	MS 1940 1996 25
2 000	2 060	30	MS 2000 2060 30
2 150	2 206	25	MS 2150 2206 25
2 380	2 436	25	MS 2380 2436 25
2 420	2 476	25	MS 2420 2476 25
2 538	2 594	25	MS 2538 2594 25
2 915	2 970	25	MS 2915 2970 25
3 530	3 585	25	MS 3530 3585 25



MORGOIL seals

d_1 167~1 593

MS..J MS..NJ H..J H..JM H..PJ

■ MORGOIL seals

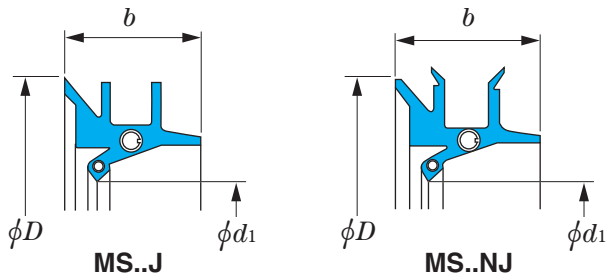

■ Seal inner rings

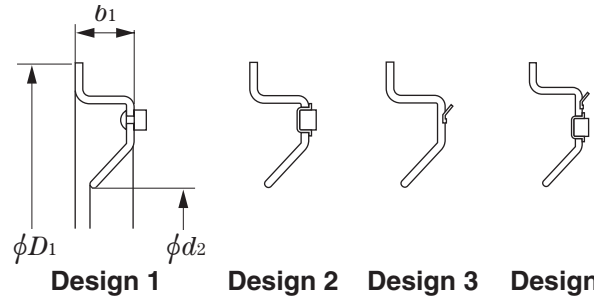

Remark) All seals use nitrile rubber.

Note 1) Special type code B represents "with a steel band" and W represents "with a wire."

d_1 167~962

MORGOIL seals				Seal inner rings				
Boundary dimensions, mm			Seal No. ¹⁾	Boundary dimensions, mm			Seal inner ring No.	Design
d_1	D	b		d_2	D_1	b_1		
167	219	41	MS 10 J	194	238	16	H 10 J	1
236	295	49	MS 14 J	270	327	17.5	H 14 J	1
275	346	51	MS 16 J	308	372	21.5	H 16 J	1
323	402	54	MS 18 J	349	421	18	H 18 J	1
369	459	60	MS 21 J MS 21 JBW	406	490	19	H 21 J	1
423	531	72	MS 24 J	475	567	27	H 24 J	1
677	798	84	MS 38 J MS 38 JB MS 38 NJBW	737	883	32	H 38 J	1
713	834	84	MS 40 J	772	940	36.5	H 40 J	1
754	907	95	MS 42 J	822	988	38	H 42 J H 42 JM	1 2
786	939	95	MS 44 J MS 44 JB MS 44 NJBW	854	1 029	38	H 44 J H 44 JM H 44 PJ	1 2 3
825	977	95	MS 46 J MS 46 NJBW	892	1 061	38 45	H 46 J H 46 JM H 46 NJM	1 2 2
866	1 018	95	MS 48 J MS 48 JB MS 48 JW MS 48 NJBW	933	1 124	44.5	H 48 J H 48 JM	1 2
901	1 054	95	MS 50 J MS 50 JB MS 50 NJ MS 50 NJB, NJBW	968	1 162	44.5 44.5 43	H 50 J H 50 J H 50 JM H 50 PJ HM 50 NJP	1 1 2 3 3
962	1 109	92	MS 54 NJBW	1 038	1 225	44.5	H 54 NJP	3

■ Mounting example

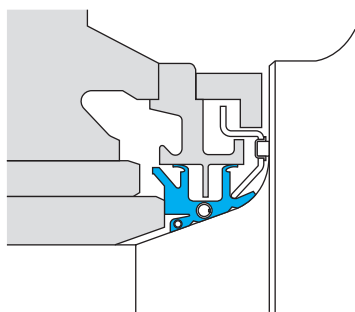

d_1 972~1 593

MORGOL seals				Seal inner rings				
Boundary dimensions, mm			Seal No. ¹⁾	Boundary dimensions, mm			Seal inner ring No.	Design
d_1	D	b		d_2	D_1	b_1		
972	1 124	95	MS 54 J MS 54 JB	1 038	1 238	44.5	H 54 J	2
							H 54 JM	2
							H 54 PJ	3
				1 052	1 252	72	H 54 SNJP	3
1 029	1 181	95	MS 56 SJ MS 56 SJB	1 098	1 289	38	H 56 J	1
							H 56 JM	2
						H 56 PJ	3	
			MS 56 NJ	1 098	1 287	44	H 56 NJP	3
			MS 56 NJBW	1 098	1 287	44	H 56 NJM	2
						H 56 NJP	3	
1 099	1 245	92	MS 60 NJBW	1 175	1 340	45	H 60 NJP	3
1 253	1 438	108	MS 68 J	1 335	1 565	69	H 68 J	1
1 542	1 712	108	MS 80 J	1 630	1 885	55	H 80 JMP	4
1 593	1 782	108	MS 82 J	1 680	1 955	82	H 82 JMP	4

Scale seals

 d 195~1 595

WR

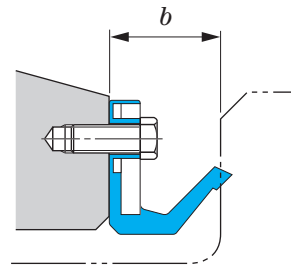
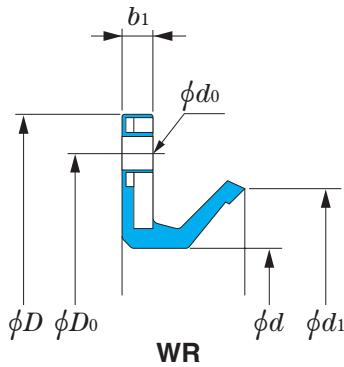

Remarks

- 1) All seals use nitrile rubber.
- 2) Consult JTEKT for drain-provided seals.

 d 195~(580)

Boundary dimensions, mm					Scale seal No.	Fixing holes		
d	D	b	b_1	d_1		D_0 mm	d_0 mm	Hole Qty (equally spaced)
195	250	26	5	222	WR 195 250 26	234	9.5	6
200	250	26	5	229	WR 200 250 26	234	9.5	6
240	300	26	5	269	WR 240 300 26	280	9.5	6
255	315	23	5	280	WR 255 315 23	295	9.5	8
280	340	25	5	304	WR 280 340 25	320	9.5	6
290	348	23	5	320	WR 290 348 23	330	9.5	8
	349	35	5	325	WR 290 N1	330	9.5	8
310	455	42.5	11	354	WR 310 455 42.5	400	17.5	Special
318	380	30	8	350	WR 318 380 30	355	9.5	6
320	373	20	3.7	351	WR 320 373 20	355	9.5	6
325	385	30	8	358	WR 325 385 30 J	360	9.5	6
330	400	35	5	370	WR 330 400 35	380	9.5	Special
335	390	22	4.5	364	WR 335 N1	370	9.5	6
340	410	26	5	369	WR 340 410 26	390	9.5	6
	435	30	5	400	WR 340 435 30 J	415	9	8
350	410	25	5	374	WR 350 410 25	390	9.5	6
	414	35	5	386	WR 350 414 35	395	10	8
	450	25	5	396	WR 350 450 25	426	11	6
365	425	27.5	5	400	WR 365 425 27.5	405	9.5	12
380	455	35	8	421	WR 380 455 35	430	12	Special
383	450	24	5	409	WR 383 450 24	430	9.5	12
405	485	32	8	442	WR 405 485 32	460	9.5	8
420	480	26	5.5	444	WR 420 N1	462	10	8
424	482	22.5	5	453	WR 424 482 22.5 J	465	9.5	12
430	490	26	8	456	WR 430 490 26	472	10	12
435	489	25.4	7	460	WR 435 489 25.4	470	10	8
	490	22.5	5	459	WR 435 490 22.5	470	9.5	8
440	510	26	8	468	WR 440 510 26	490	9	12
448	510	28.4	6	485	WR 448 510 28.4	490	12	Special
458	540	26	6	485	WR 458 N2	458	11.5	12
480	550	28	6	507	WR 480 550 28	525	9.5	6
490	560	26	6	523	WR 490 N1	535	9.5	8
550	610	22	6	578	WR 550 610 22	590	9.5	8
566	622	25	4.7	594	WR 566 622 25	603	12	6
580	650	51	8	632	WR 580 650 51	626	12	12

d (580)~1 595

Boundary dimensions, mm					Scale seal No.	Fixing holes		
<i>d</i>	<i>D</i>	<i>b</i>	<i>b</i> ₁	<i>d</i> ₁		<i>D</i> ₀ mm	<i>d</i> ₀ mm	Hole Q'ty (equally spaced)
580	655	32	10	628	WR 580 655 32	632	Special	8
645	719	30	4.5	684	WR 645 N1	690	12	12
730	830	57	7	770	WR 730 N1	790	13	12
740	840	55	9	786	WR 740 840 55	800	12	12
760	835	33	6	802	WR 760 N2	810	11	8
840	915	35	8	876	WR 840 915 35	890	12	8
870	980	40	8	912	WR 870 980 40	940	14	12
890	1 000	50	8	948	WR 890 1000 50	950	18	12
992	1 064	26	6	1 020	WR 992 1064 26	1 040	12	Special
1 000	1 108	38	8	1 040	WR 1000 1108 38	1 065	14	12
1 025	1 080	45	9	1 053	WR 1025 1080 45	1 060	9	12
1 105	1 180	40	6	1 145	WR 1105 1180 40	1 156	14	16
1 115	1 220	40	10	1 150	WR 1115 1220 40	1 180	14	12
1 200	1 270	38	8	1 242	WR 1200 1270 38	1 242	12	16
1 595	1 750	48	7.6	1 663	WR 1595 1750 48 J	1 700	14	20

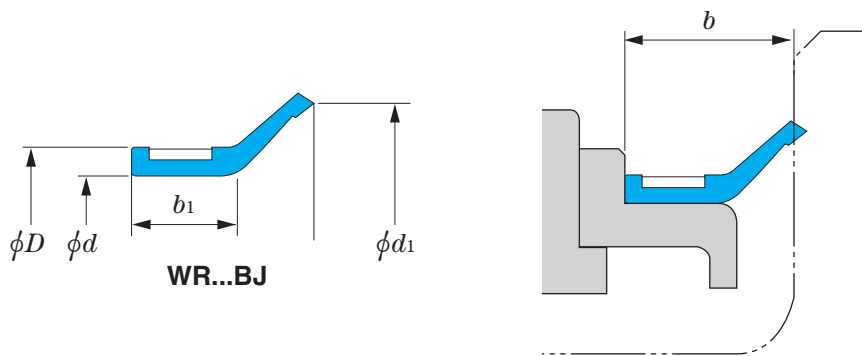
Scale seals*d* 280~1 340**WR...BJ**

Remarks

- 1) All seals use nitrile rubber.
- 2) Consult JTEKT for drain-provided seals.

d 280~1 340

Boundary dimensions, mm					Scale seal No.
<i>d</i>	<i>d</i> ₁	<i>b</i>	<i>b</i> ₁	<i>D</i>	
280	292	27	22.5	288	WR 280 288 27 BJ
326	342.5	38	23	336	WR 326 336 38 BJ
337	352	38	28	347	WR 337 347 38 BJ
390	400	35	25	400	WR 390 400 35 BJ
395	405	38	25	405	WR 395 405 38 BJ
420	452	35	25	435	WR 420 435 35 BJ
445	461	35	25	461	WR 445 461 35 BJ
	478	35	25	470	WR 445 470 35 BJ
500	516	56.5	35	516	WR 500 516 56.5 BJ – 1
533	546	31.5	22	543	WR 533 543 31.5 BJ – 1
593	631	48	24	610	WR 593 610 48 BJ
595.3	611.3	29	22	611	WR 595.3 611.3 29 BJ
600	616	45	28	616	WR 600 616 45 BJ
625	671	35	22	641	WR 625 641 35 BJ
720	766	35	22	736	WR 720 736 35 BJ
750	792	45	25	766	WR 750 766 45 BJ
760	776	56.5	35	776	WR 760 776 56.5 BJ
800	854	56.5	35	816	WR 800 816 56.5 BJ
824	840	45	25	840	WR 824 840 45 BJ
900	942	45	25	916	WR 900 916 45 BJ
995	1 044	50	32	1 011	WR 995 1011 50 BJ
1 130	1 146	45	25	1 146	WR 1130 1146 45 BJ
1 340	1 389	50	32	1 356	WR 1340 1356 50 BJ

Scale seals

 d_1 210~1 203

WR...RJ MH...J H...J

Koyo

■ Scale seal

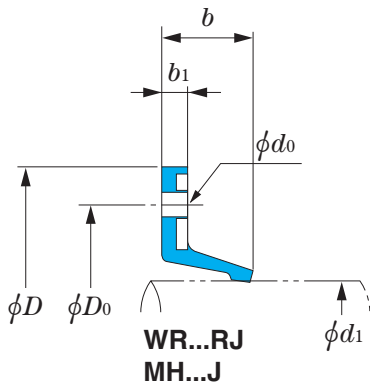

■ Scale cover

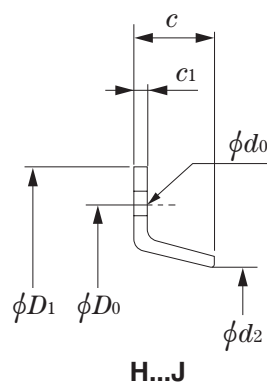

Remarks

- 1) All seals use nitrile rubber.
- 2) Consult JTEKT for drain-provided seals.

 d_1 210~1 203

Scale seal					Scale cover				Fixing holes			
Boundary dimensions, mm				Scale seal No.	Boundary dimensions, mm				Scale cover No.	D_0 mm	d_0 mm	Hole Q'ty (equally spaced)
d_1	D	b	b_1		d_2	D_1	c	c_1				
210	300	16	4	MH 210 300 4J	218	300	18	2	H 210 300 18 J	275	10	Special
235	340	25	5	WR 235 340 25 RJ	-	-	-	-	-	300	11.5	5
300	380	26	6	MH 300 380 6 J	-	-	-	-	-	350	10	6
395	475	35	6	MH 395 475 6 J	409	475	33	5	H 395 475 33 J	455	10	Special
425	490	16.8	5	MH 425 490 5 J	-	-	-	-	-	470	9.5	8
460	535	35	7	WR 460 535 35 RJ	475	535	45	5	H 460 535 45 J	515	12	Special
470	610	36.5	8.5	WR 470 610 35 RJ	-	-	-	-	-	570	21	Special
510	580	25	5	WR 510 580 25 RJ	524	580	30	3.2	H 510 580 30 J	562	9.5	8
550	624	35	8	MH 550 624 8 J	556	624	40	5	H 550 624 40 J	605	10	Special
580	654	34	8	WR 580 654 34 RJ	589	654	40	5	H 580 654 40 J	635	10	12
584	685	25	5	WR 584 685 25 RJ	-	-	-	-	-	635	9	8
623	705	32	8	MH 623 705 8 J	635	705	30	5	H 623 705 30 J	685	12	Special
690	770	35	8	MH 690 770 8 J	700	770	40	5	H 690 770 40 J	745	10	Special
					695	770	55	5	H 690 770 55 J	745	10	Special
696	780	32	8	MH 696 780 8 J	705	780	30	5	H 696 780 30 J	750	14	8
	780	37	8	WR 696 780 32 RJ	-	-	-	-	-	750	10	Special
760	845	35	8	MH 760 845 8 J	770	845	33	5	H 760 845 33 J	820	10	12
805	885	35	8	MH 805 885 8 J	815	885	37	5	H 805 885 37 J	860	10	12
815	880	35	10	MH 815 880 8 J	828	880	27	5	H 815 880 27 J	865	9	12
820	925	35	8	MH 820 925 8 J	834	925	35	5	H 820 925 35 J	890	14	Special
850	925	30	8	MH 850 925 8 J	857	925	30	5	H 850 925 30 J	900	10	Special
920	995	35	8	WR 920 995 35 RJ	-	-	-	-	-	970	10	12
950	1 090	50	10	WR 950 1090 50 RJ	-	-	-	-	-	1 050	17	16
970	1 070	35	8	WR 970 1070 35 RJ	-	-	-	-	-	1 040	12	12
990	1 090	40	8	WR 990 1090 40 RJ	-	-	-	-	-	1 060	14	12
1 030	1 120	40	8	WR 1030 1120 40 RJ	-	-	-	-	-	1 090	15	12
1 117	1 230	41.5	10	WR 1117 1230 40 RJ	1 137	1 230	45	5	H 1117 1230 45 J	1 200	14	18
1 120	1 220	35	10	MH 1120 1220 10 J	1 132	1 220	33	5	H 1120 1220 33 J	1 190	14	12
1 193	1 290	35	10	MH 1193 1290 10 J	1 206	1 290	33	5	H 1193 1290 33 J	1 260	13	12
1 203	1 300	35	10	MH 1203 1300 10 J	1 215	1 300	33	5	H 1203 1300 33 J	1 270	13	Special

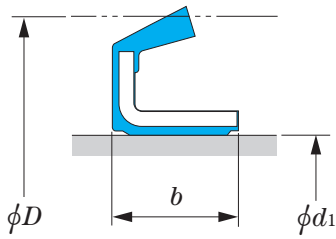
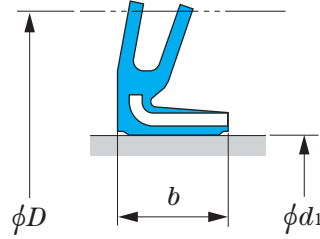
Water seals d_1 219.2~1 460**XMH XM XMHE****XMH****XM
XMHE****Remarks**

- 1) For seals marked ○, JTEKT owns moulding dies for production.
- 2) Seal number is constructed by combination of type code and dimensional numbers (bore diameter, outside diameter and width). Example: XMHE77081029 (770×810×29 mm)
- 3) All seals use nitrile rubber.

 d_1 219.2~760

Boundary dimensions, mm			Seal type		
d_1	D	b	XMH	XM	XMHE
219.2	240	6		○	
230	260	15	○		
245	275	12	○		
265	295	15	○		
274	304	13	○		
296	324	15	○		
345	375	15			○
350	380	20	○		
360	390	20	○		
	400	20			○
365	405	12	○		
	405	18	○		
400	440	20			○
420	470	20		○	
440	480	20		○	
465	505	25		○	
485	525	25		○	
490	530	20			○
520	560	20			○
560	600	25		○	
580	624	25		○	
610	660	25		○	
620	660	25			○
640	680	25			○
680	720	25			○
720	770	25			○
740	780	30			○
	810	45			○
750	800	25			○
760	820	38			○

d_1 800~1 460

Boundary dimensions, mm			Seal type		
d_1	D	b	XMH	XM	XMHE
800	840	20			○
834	884	25			○
850	900	30			○
880	930	25			○
905	955	25			○
940	990	25			○
980	1 030	25			○
1 030	1 090	30			○
1 040	1 090	25			○
1 060	1 110	25			○
1 080	1 130	25		○	
1 090	1 150	25		○	
1 110	1 160	25		○	
1 200	1 250	30			○
1 460	1 510	25			○

V-rings

d 38~875

MV...A

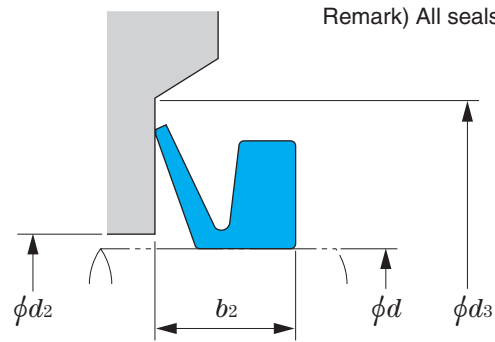
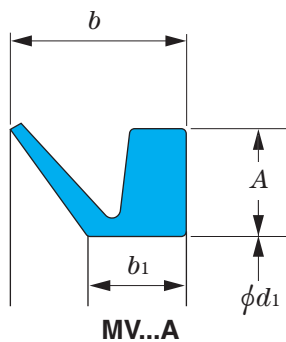

Remark) All seals use nitrile rubber.

d 38~875

V-ring No.	Shaft diameter	Boundary dimensions, mm				Mounted dimensions, mm		
	<i>d</i> , mm (from-to)	<i>d</i> ₁	<i>A</i>	<i>b</i>	<i>b</i> ₁	<i>d</i> ₂ (max.)	<i>d</i> ₃ (min.)	<i>b</i> ₂
MV 40 A	38 ~ 43	36	5	9	5.5	<i>d</i> + 3	<i>d</i> + 15	7.0 ± 1.0
MV 60 A	58 ~ 63	54						
MV 90 A	88 ~ 93	81	6	11	6.8	<i>d</i> + 4	<i>d</i> + 18	9.0 ± 1.2
MV 100 A	98 ~ 105	90						
MV 120 A	115 ~ 125	108	7	12.8	7.9	<i>d</i> + 5	<i>d</i> + 21	10.5 ± 1.5
MV 130 A	125 ~ 135	117						
MV 140 A	135 ~ 145	126						
MV 150 A	145 ~ 155	135						
MV 170 A	165 ~ 175	153	8	14.5	9	<i>d</i> + 5	<i>d</i> + 24	12.0 ± 1.8
MV 199 A	195 ~ 210	180						
MV 250 A	235 ~ 265	225	15	25	14.3	<i>d</i> + 10	<i>d</i> + 45	20.0 ± 4.0
MV 275 A	265 ~ 290	247						
MV 325 A	310 ~ 335	292						
MV 350 A	335 ~ 365	315						
MV 375 A	365 ~ 390	337						
MV 400 A	390 ~ 430	360						
MV 450 A	430 ~ 480	405						
MV 500 A	480 ~ 530	450						
MV 550 A	530 ~ 580	495						
MV 600 A	580 ~ 630	540						
MV 650 A	630 ~ 665	600						
MV 750 A	745 ~ 785	705						
MV 800 A	785 ~ 830	745						
MV 850 A	830 ~ 875	785						

2

O-Rings

2.1 Classification of O-ring and backup ring	88
(1) O-ring classification and application guide	88
(2) Backup ring types and material	88
2.2 Numbering systems of O-ring and backup ring	89
(1) O-ring designation numbers	89
(2) Backup ring designation numbers	89
2.3 Selection of O-ring	90
(1) O-ring materials	90
(2) Selection of O-ring material	92
(3) Selection of cross section diameter	93
2.4 O-ring technical principles	94
(1) Sealing mechanism	94
(2) Backup ring	94
(3) O-rings for dynamic sealing	94
(4) O-rings for static sealing of cylindrical surface	94
(5) O-rings for static sealing of flat surface	95
(6) O-rings for vacuum flanges	95
(7) Installation in triangular groove	95
2.5 Fitting groove design for O-ring	96
(1) Compression amount and compression rate	96
(2) Extrusion into gap from fitting groove	97
(3) Fitting groove surface roughness	97
(4) Chamfer of installation location	97
(5) Material and surface finishing of fitting groove parts	98
2.6 O-ring handling	98
(1) Storage	98
(2) Handling	98
2.7 Typical O-ring failures, causes and countermeasures	99
2.8 O-ring dimensional tables (Contents)	101

2.1 Classification of O-ring and backup ring

(1) O-ring classification and application guide

O-rings are used in a various machines as a compact sealing component. O-rings can generally be classified into dynamic applications ("packing") and static applications ("gaskets").

Other classification is according to their properties, such as oil resistance. O-rings are specified in the industrial standards listed in Table 2.1.1.

Table 2.1.1 O-ring classification and application guide

Application	General industrial machines		Automobiles	Aircraft		
Applicable standards	JIS B 2401		JASO F 404	AS 568 AN 6227 AN 6230		
Classification	Class	Remarks	Remarks	Class	Remarks	Remarks
Material	Class 1-A	For mineral oil (A70)*	For mineral-base fluids Class: JIS Class 1-A (A 70)*	Class 1-A	For general mineral oil	For mineral-base fluids Class: JIS Class 1-A (A 70)* JIS Class 1-B (A 90)* JIS Class 4-D
	Class 1-B	For mineral oil (A90)*		Class 2	For gasoline	
	Class 2	For gasoline		Class 3	For brake fluid	
	Class 3	For animal oil and vegetable oil		Class 4-C	For high temperature applications	
	Class 4-C	For high temperature applications		Class 4-D	For high temperature applications	
	Class 4-D	For high temperature applications	Class 4-E	For high temperature applications		
Remarks	P: For dynamic / static sealing G: For static sealing V: For vacuum flanges S: For static sealing (not standardized in the JIS)		For general industrial use	For dynamic / static sealing		AS 568 : For static sealing AN 6227 : For dynamic / static sealing AN 6230 : For static sealing

*: Hardness measured by durometer type A

(2) Backup ring types and material

Backup rings are used with O-rings to prevent O-ring protrusion from the groove.

Backup rings are used for dynamic sealing and for static sealing of cylindrical surface.

Table 2.1.2 shows backup ring types and material.

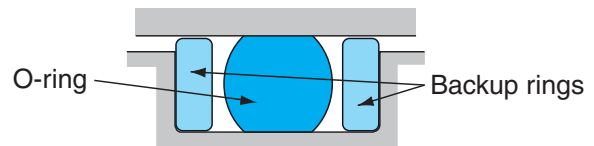

Fig. 2.1.1 O-ring installation with backup rings

Table 2.1.2 Backup ring types and material

Applicable standard	JIS B 2407		
Type	T1: Spiral ring	T2: Bias-cut ring	T3: Endless ring
Shape			
Material	Tetrafluoroethylene resin		
Applications	For dynamic sealing / static sealing of cylindrical surface		

2.2 Numbering systems of O-ring and backup ring

(1) O-ring designation numbers

O-ring designation number consists of material code, application code, and dimensional code.

Table 2.2.1 O-ring numbering system

Example

	P	26	JIS product ¹⁾
1B	G	80	JIS product ¹⁾
2	JASO	1013	JASO product ²⁾
	AS	325	AS product ³⁾
	B	0212G	ISO product ⁴⁾

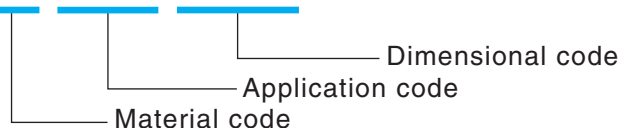

- Notes
- 1) JIS: Japanese Industrial Standards
 - 2) JASO: Japanese Automobile Standard Organization
 - 3) AS: Aeronautical Standard
 - 4) ISO: International Organization for Standardization

1) Material codes

Code	Basic standard	Remarks
None	JIS B 2401 Class 1-A	Nitrile rubber (A70)*
1B	JIS B 2401 Class 1-B	Nitrile rubber (A90)*
2	JIS B 2401 Class 2	Nitrile rubber (gasoline-resistant)
3	JIS B 2401 Class 3	Styrene-butadiene rubber
4C	JIS B 2401 Class 4-C	Silicone rubber
4D	JIS B 2401 Class 4-D	Fluorocarbon rubber
4E	JASO F 404 Class 4-E	Acrylic rubber
5	JASO F 404 Class 5	Ethylene propylene rubber

* : Hardness measured by durometer type A

2) Application codes

Code	Basic standard	Remarks
P	JIS B 2401 P	For dynamic sealing / static sealing of cylindrical or flat surface
G	JIS B 2401 G	For static sealing of cylindrical or flat surface
V	JIS B 2401 V	For vacuum flange
S	Slim series	For static sealing of cylindrical or flat surface
JASO	JASO F 404	For dynamic sealing / static sealing of cylindrical or flat surface
AS	AS 568	For static sealing of cylindrical or flat surface
	AN 6227	For dynamic sealing / static sealing of cylindrical surface
	AN 6230	For static sealing of cylindrical surface
A B C D E	ISO 3601	For general industrial machines

(2) Backup ring designation numbers

Backup ring designation number consists of type code and the O-ring number for which the backup ring is applied.

Table 2.2.2 Backup ring numbering system

Example

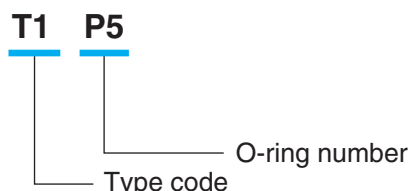

■ Type codes

Code	Backup ring shape
T1	Spiral
T2	Bias-cut
T3	Endless

Remark) Backup ring types and shapes are listed in Table 2.1.2.

2.3 Selection of O-ring

(1) O-ring materials

Materials conforming to JIS B 2401 or JASO F 404 standards are mainly used. Major rubber materials and their physical properties are listed in Table 2.3.1.

Consult JTEKT for special materials to suit a wide variety of applications.

Table 2.3.1 O-ring rubber materials and their physical properties

Applicable standards		JIS B 2401					-			-
		JASO F 404		-			JASO F 404			
Class		Class 1-A	Class 1-B	Class 2	Class 3		Class 4-C	Class 4-D	Class 4-E	Class 5
Rubber materials		Nitrile rubber (NBR)	Nitrile rubber (NBR)	Nitrile rubber (NBR)	Styrene-butadiene rubber (SBR)		Silicone rubber (VMQ)	Fluorocarbon rubber (FKM)	Acrylic rubber (ACM)	Ethylene-propylene rubber (EPDM)
Test items		Applications		For mineral oil	For gasoline	For animal oil and vegetable oil	For high temperature applications			For coolant
Normal properties	Hardness by durometer type A	A70/S ± 5	A90/S ± 5	A70/S ± 5	A70/S ± 5		A70/S ± 5	A70/S ± 5	A70/S ± 5	A70/S ± 5
	Tensile strength (MPa), min.	9.8	14	9.8	9.8		3.4	9.8	5.9	9.8
	Elongation (%), min.	250	100	200	150		60	200	100	150
	Tensile stress (MPa), min. (at 100 % elongation)	2.7	-	2.7	2.7		-	1.9	-	2.7
Aging tests	Temperature and duration	120 °C, 70 hours		100 °C, 70 hours			230 °C, 24 hours		150 °C, 70 hours	120 °C, 70 hours
	Change in hardness, max.	+ 10	+ 10	+ 10	+ 10		+ 10	+ 5	+ 10	+ 10
	Change in tensile strength (%), max.	- 15	- 25	- 15	- 15		- 10	- 10	- 30	- 20
	Change in elongation (%), max.	- 45	- 55	- 40	- 45		- 25	- 25	- 40	- 40
Compression set test	Temperature and duration	120 °C, 70 hours		100 °C, 70 hours			175 °C, 22 hours		150 °C, 70 hours	120 °C, 70 hours
	Compression set (%), max.	40	40	25	25		30	40	60	40
Immersion test	Temperature, duration, and testing oil	120 °C, 70 hours, ASTM No.1 oil		23 °C, 70 hours, fuel oil No.1 ¹⁾	100 °C, 70 hours, brake fluid ¹⁾		175 °C, 70 hours, ASTM No.1 oil		150 °C, 70 hours, ASTM No.1 oil	100 °C, 70 hours, coolant
	Change in hardness	- 5 ~ + 8	- 5 ~ + 8	- 8 ~ 0	- 15 ~ 0		- 10 ~ + 5	- 10 ~ + 5	- 7 ~ + 10	- 5 ~ + 5
	Change in tensile strength (%), max.	- 15	- 20	- 15	- 40		- 20	- 20	- 30	- 30
	Change in elongation (%), max.	- 40	- 40	- 25	- 40		- 20	- 20	- 40	- 30
	Change in volume (%)	- 8 ~ + 5	- 8 ~ + 5	- 3 ~ + 5	0 ~ + 12		0 ~ + 10	- 5 ~ + 5	- 5 ~ + 5	- 5 ~ + 10
	Temperature, duration, and testing oil	120 °C, 70 hours, IRM903 oil		23 °C, 70 hours, fuel oil No.2 ¹⁾				175 °C, 70 hours, IRM903 oil	150 °C, 70 hours, IRM903 oil	
	Change in hardness	- 15 ~ 0	- 10 ~ + 5	- 20 ~ 0				- 10 ~ + 5	- 20 ~ 0	
	Change in tensile strength (%), max.	- 25	- 35	- 45				- 20	- 40	
Change in elongation (%), max.	- 35	- 35	- 45				- 20	- 40		
Change in volume (%)	0 ~ + 20	0 ~ + 20	0 ~ + 30				- 5 ~ + 5	0 ~ + 30		
Low temperature brittleness test	Non-destructive temperature (°C)	- 13	-	- 10	- 40		- 50	- 15	- 1	- 40
Low temperature bending test	Temperature and duration	- 30 °C ~ - 35 °C, 5 hours								
	Appearance	Test two pieces firstly for checking any crack. If one does have a crack, test again on another two pieces from the same lot and re-check and confirm that there is no crack.								
Corrosion test and stickiness test	Temperature and duration	70 ± 1 °C, 24 hours								
	Appearance	The rubber should not corrode the metal with which it is in contact nor should it become sticky. However, metal surface decoloration should not be judged as corrosion.								

Note 1) For details, see the appendix of JIS B 2401.

(2) Selection of O-ring material

O-rings have contact with substances to be sealed. Therefore, material should be chemically stable to such substances.

Table 2.3.2 below lists the substances with which each rubber material can remain stable. Consult JTEKT for further details.

- ⊙ : Resistant to the substance
- : Resistant to the substance except under extreme conditions
- △ : Not resistant to the substance except under specific favorable conditions
- × : Not resistant to the substance

Table 2.3.2 O-ring rubber materials and their stability to fluids

Applicable standard	JIS B 2401								
	JASO F 404	—	JASO F 404			—	—	—	—
Class	Class 1-A	Class 1-B	Class 2	Class 3	Class 4-C	Class 4-D	Class 4-E	Class 5	
Rubber material	Nitrile rubber (NBR)	Nitrile rubber (NBR)	Nitrile rubber (NBR)	Styrene-butadiene rubber (SBR)	Silicone rubber (VMQ)	Fluorocarbon rubber (FKM)	Acrylic rubber (ACM)	Ethylene-propylene rubber (EPDM)	
Operating temperature range (°C) (Guidance)	− 30 ~ 100	− 25 ~ 100	− 25 ~ 80	− 50 ~ 80	− 50 ~ 200	− 15 ~ 200	− 15 ~ 130	− 45 ~ 130	
Weatherability	Ozone resistance	△	△	△	⊙	⊙	⊙	⊙	
	Flame resistance	×	×	×	○	⊙	×	×	
	Radiation resistance	△	△	△	○	△	×	○	
	Coal gas	○	⊙	⊙	△	△	○	△	
	Liquefied petroleum gas	○	⊙	⊙	×	×	⊙	△	
Resistance to lubrication oils	Gear oil	⊙	○	×	×	△	⊙	×	
	Engine oil	⊙	○	×	×	△	⊙	×	
	Machine oil	⊙	⊙	⊙	×	○	⊙	×	
	Spindle oil	⊙	⊙	⊙	×	△	○	×	
	Lithium grease	⊙	⊙	⊙	×	⊙	⊙	×	
	Silicone grease	⊙	⊙	⊙	○	×	⊙	⊙	
	Cup grease	⊙	⊙	⊙	×	△	○	×	
	Refrigeration oil(mineral oil)	○	⊙	⊙	×	△	⊙	×	
Resistance to hydraulic fluids	Turbine oil	⊙	⊙	×	×	○	⊙	×	
	Torque-converter oil	△	⊙	×	×	△	⊙	×	
	Brake fluid	△	△	⊙	⊙	○	△	⊙	
	Silicone oil	⊙	⊙	⊙	○	×	⊙	⊙	
	Phosphoric ester	×	×	×	×	○	×	⊙	
	Water + glycol	○	○	○	○	△	○	⊙	
	Oil + water emulsion	⊙	⊙	⊙	△	△	○	△	
Resistance to fuel oils and water	Gasoline	△	○	×	×	×	×	×	
	Light oil and kerosene	△	⊙	×	×	×	×	×	
	Heavy oil	△	○	×	×	×	×	×	
	Cold water and warm water	○	○	○	○	○	×	⊙	
	Steam and hot water	○	○	○	○	△	×	⊙	
	Water including antifreeze fluid	○	○	○	△	△	×	⊙	
	Water-based cutting oil	○	○	○	△	△	×	△	
Chemical resistance	Trichloroethylene	×	×	×	×	×	×	×	
	Alcohol	○	○	⊙	○	○	×	⊙	
	Benzene	×	×	×	×	×	×	×	
	Ethylene glycol	⊙	⊙	⊙	⊙	⊙	△	⊙	
	Acetone	×	×	△	△	△	×	○	
	Hydrochloric acid 20 %	△	△	○	△	△	△	⊙	
	Sulfuric-acid 30 %	○	○	○	○	○	△	⊙	
	Nitric-acid 10 %	×	×	×	×	×	×	○	
	Caustic soda 30 %	⊙	⊙	⊙	⊙	×	×	⊙	
Features	<ul style="list-style-type: none"> • The most common material • High resistance to oil, abrasion and heat • Hardness: A70 	<ul style="list-style-type: none"> • Harder and higher pressure-resistance than Class 1-A rubber • Same properties as Class 1-A rubber in other respects • Hardness: A90 	<ul style="list-style-type: none"> • High resistance to fuel oils, such as gasoline, light oil and kerosene 	<ul style="list-style-type: none"> • High resistance to animal oil and vegetable oil, such as brake fluid 	<ul style="list-style-type: none"> • High resistance to high and low temperature • Excellent self-restoration after compression, under a wide temperature range 	<ul style="list-style-type: none"> • Highest resistance to oils, chemicals, and heat • Useful over a wide temperature range 	<ul style="list-style-type: none"> • Superior to nitrile rubber in terms of heat resistance and oil resistance • Especially resistant to high temperature oil 	<ul style="list-style-type: none"> • Superior in ozone resistance, heat resistance and electrical insulation resistance 	

(3) Selection of cross section diameter

When sealing fluid with O-ring, design the O-ring so that the depth of groove for fitting it is smaller than the thickness of the O-ring to compress (squeeze) it (provide compression amount). Determine this compression carefully, because O-rings may become permanently deformed if squeezed excessively, thus deteriorating sealing performance.

Generally, the compression rate of an O-ring should be between 8 % and 30 % in ring cross section diameter (the lower limit of 8 % for sufficient sealing performance and the upper limit of 30 % for limited compression set.).

Fig. 2.3.1 shows the relation between O-ring cross section diameter and compression set.

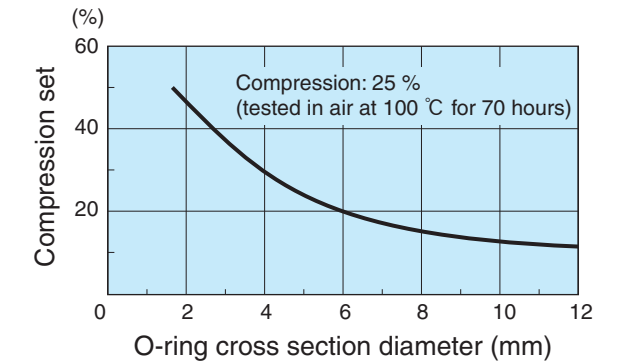

Fig. 2.3.1 Relation between O-ring cross section diameter and compression set

Larger cross section diameter offers more stable sealing performance. As shown in Fig. 2.3.1, when the O-ring compression rate is constant (25 % in the figure), the larger cross section diameter shows the smaller the compression set. Larger cross section diameter is advantageous in that it can accommodate errors in installation dimensions as well.

In dynamic-sealing applications, larger cross section diameter is less likely to twist during service or during installation. The largest cross section diameter possible should be selected providing it can fit in the available space.

2.4 O-ring technical principles

(1) Sealing mechanism

Fig. 2.4.1 shows how O-ring can be deformed under pressure.

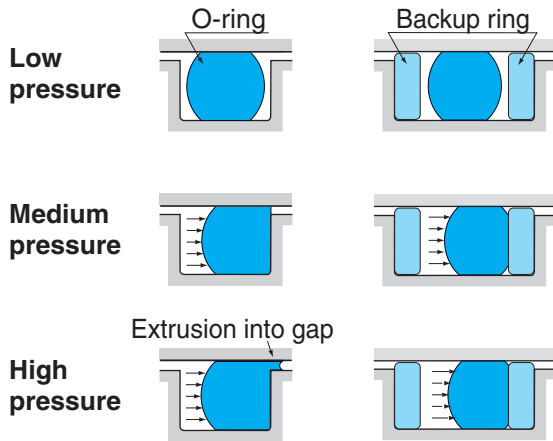

Fig. 2.4.1 O-ring deformation under pressure

O-ring installed in a groove with compression (compression rate) of 8 % to 30 % provides a self-seal by its elasticity when the pressure is low.

When operation pressure is higher, the O-ring is pressed against one side of the groove, providing better sealing. However, under extremely high pressure, the O-ring partially is pressed out from groove into the gap and may be damaged, and deteriorated sealing performance.

For such high-pressure applications, one or two backup rings should be applied to prevent extrusion into gap.

(2) Backup ring

Backup rings are used for dynamic sealing and for static sealing of cylindrical surface.

Two backup rings should be installed on both sides of O-ring when high pressure is put on the O-ring in two directions. One backup ring is installed on low pressure side of O-ring when high pressure is applied in one direction.

Even when extrusion into gap does not occur under low pressure, backup rings are recommended because they can extend O-ring service life by preventing O-ring tearing or damage, which are the most common causes of O-ring failures.

One each backup ring is installed on both sides of O-ring normally (total is two backup rings). However, if space does not allow this, one backup ring should be installed on the lower-pressure side.

The O-ring extrusion varies depending on applied pressure, O-ring hardness and gap amount on the cylindrical surface. Refer to Fig. 2.5.1, "O-ring extrusion limit values," when using backup rings.

Backup rings of endless design (T3) are the most advantageous in the prevention of extrusion into the gap. However, those of spiral design (T1) and bias-cut design (T2) can be more easily installed.

All Koyo backup rings are made from tetrafluoroethylene (PTFE) resin, which is chemically stable to all media under a wide range of temperatures and is resistant to corrosion.

(3) O-rings for dynamic sealing (Reciprocal movement)

When fitting groove is provided on the piston, use two O-rings to ensure improved service life and sealing performance (Fig. 2.4.2). Pack grease between the two O-rings in a non-lubrication application. Recommended grease is lithium soap base with NLGI No. 2.

When fitting groove is provided on the cylinder, use a dust seal as well and pack grease between the O-ring and dust seal.

Groove on piston

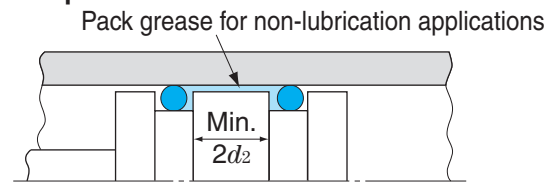

Groove on cylinder

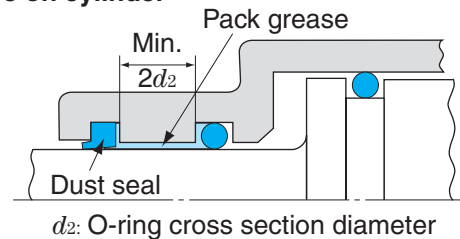

Fig. 2.4.2 Typical installation of O-ring for dynamic sealing

For the installation of O-rings on cast cylinders or for low-friction dynamic-sealing applications, consult JTEKT.

(4) O-rings for static sealing of cylindrical surface

When O-ring is used under low pressure with the compression rate close to the minimal of 8 %, the fitting groove accuracy affects sealing performance so much, so that the groove accuracy should be controlled at the same level as the fitting groove of dynamic sealing.

Even when an O-ring is selected in accordance with the dimensional table values and groove dimensions, the O-ring may become slack due to dimensional deviation and installation method, which may be caused by the reason why the O-ring is unduly caught between the groove and housing (Fig. 2.4.3).

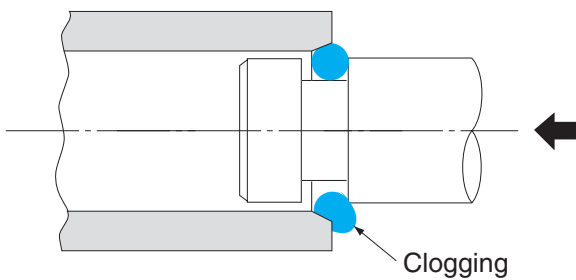

Fig. 2.4.3 O-ring slack and clogging

Especially large size O-rings must be installed with care to avoid ring slack.
 To prevent ring slack for the ring size of 150 mm or more, a slightly smaller size O-ring may be used rather than one that exactly fits the groove dimensions after determining the O-ring compression amount carefully. Consult JTEKT for this method.

(5) O-rings for static sealing of flat surface

Determine the O-ring compression amount to be slightly larger than in other applications.
 If the O-ring is exposed to internal pressure, the O-ring outside diameter should be determined, according to groove diameter ϕd_7 . When the O-ring is exposed to external pressure, O-ring bore diameter should be determined according to groove diameter ϕd_8 (see Fig. 2.4.4 (a) and (b)).
 If the O-ring is exposed to pressure in one direction, the groove side face on the high-pressure side can be eliminated for easy machining (Fig. 2.4.4 (c)).
 In this case, dimension B should be greater than the minimum of the groove width b (Fig. 2.4.4(a)) used in flat surface static-sealing application.

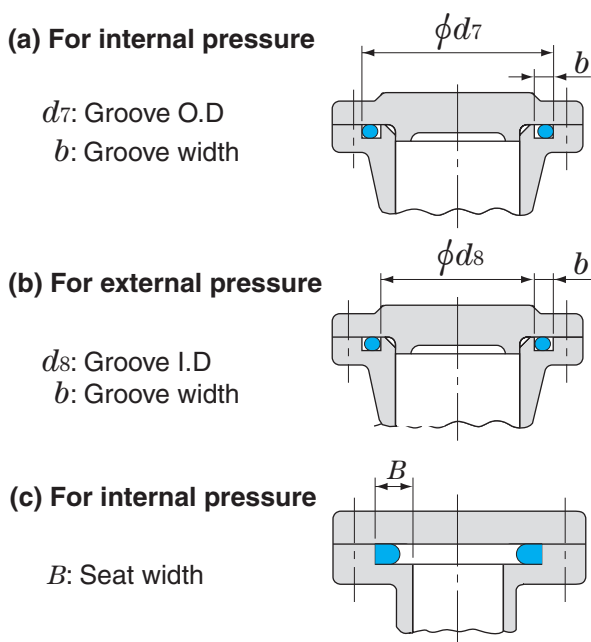

Fig. 2.4.4 Fitting groove for static sealing of flat surface

In the case of internal-pressure applications and O-ring size is small (30 mm or less), groove outside diameter ϕd_7 should be 0.2 to 0.3 mm larger to ensure correct O-ring installation.

In the case of thin O-ring (cross section diameter 3 mm or less) of large size (150 mm or more), it may be installed on the groove incorrectly and partially protruding from the groove, which results in cutting off of O-ring. Such a situation must be avoided. Use thicker O-ring to prevent such a protrusion (Fig. 2.4.5).

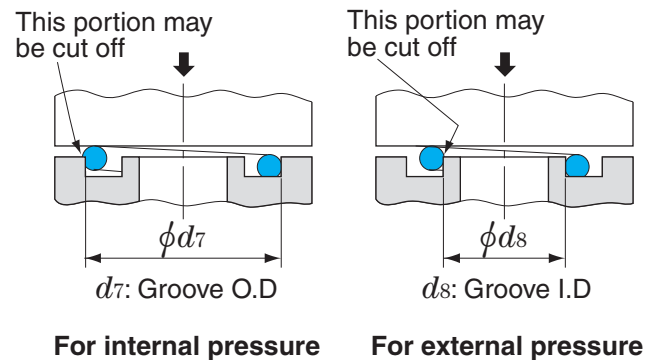

Fig. 2.4.5 O-ring protrusion

(6) O-rings for vacuum flanges

In vacuum applications, O-rings are used to seal in gases. Therefore, fitting groove surfaces should be carefully machined and finished.
 To select a suitable rubber material to meet vacuum grade, consult JTEKT.

(7) Installation in triangular groove

When O-ring is installed on the interior angle on a shaft or flange, the A dimension of the triangular groove should be 1.3 to 1.4 times of the O-ring cross section diameter (Fig. 2.4.6).

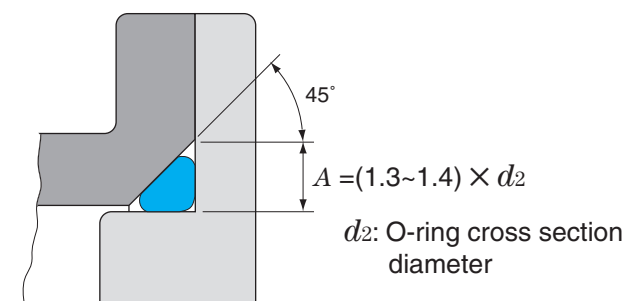

Fig. 2.4.6 Triangular-groove dimensions

2.5 Fitting groove design for O-ring

(1) Compression amount and compression rate

Table 2.5.1 lists the JIS-standard of O-ring Compression amount and compression rate.

See dimension table for each groove dimensions corresponding to O-ring number.

Compression amounts of standards other than JIS are shown in respective dimensional tables.

Fig.2.5.1 shows the details of relation between the shape of groove and the compression amount and compression rate.

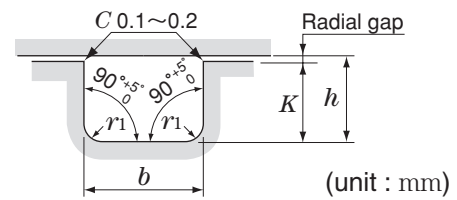

- 1) Groove depth K
Determine dimension h to obtain O-ring compression rate between 8 % and 30%.
Determine the radial gap by the consideration that the double radial gap (gap in diameter) should be less than the value shown in Fig. 2.5.2.

$$\text{Compression amount} = d_2 - h$$

$$\text{Compression rate} = \frac{d_2 - h}{d_2} \times 100 (\%)$$

d_2 : O-ring cross section diameter

- 2) Groove width b
Determine groove width by the consideration that O-ring should not occupy more than 90 % of the groove space.

$$\text{Occupancy percentage} = \frac{\pi \times (d_2 / 2)^2}{b \times h} \times 100 (\%)$$

Fig. 2.5.1 Relation between shape of groove and compression amount (rate)

Table 2.5.1 O-ring compression amount and compression rate

O-ring number	O-ring dimensions, mm		Compression amount and compression rate							
			For dynamic sealing /static sealing of cylindrical surface				For static sealing of flat surface			
	Cross section diameter d_2	Bore diameter d_1	mm		%		mm		%	
			Max.	Min.	Max.	Min.	Max.	Min.	Max.	Min.
P3 ~ P10	1.9 ±0.08	2.8 ~ 9.8	0.48	0.27	24.2	14.8	0.63	0.37	31.8	20.3
P10A ~ P18	2.4 ±0.09	9.8 ~ 17.8	0.49	0.25	19.7	10.8	0.74	0.46	29.7	19.9
P20 ~ P22		19.8 ~ 21.8								
P22A ~ P40	3.5 ±0.1	21.7 ~ 39.7	0.60	0.32	16.7	9.4	0.95	0.65	26.4	19.1
P41 ~ P50		40.7 ~ 49.7								
P48A ~ P70	5.7 ±0.13	47.6 ~ 69.6	0.83	0.47	14.2	8.4	1.28	0.92	22.0	16.5
P71 ~ P125		70.6 ~ 124.6								
P130 ~ P150		129.6 ~ 149.6								
P150A ~ P180	8.4 ±0.15	149.5 ~ 179.5	1.05	0.65	12.3	7.9	1.70	1.30	19.9	15.8
P185 ~ P300		184.5 ~ 299.5								
P315 ~ P400		314.5 ~ 399.5								
G25 ~ G40	3.1 ±0.1	24.4 ~ 39.4	0.70	0.40	21.85	13.3	0.85	0.55	26.6	18.3
G45 ~ G70		44.4 ~ 69.4								
G75 ~ G125		74.4 ~ 124.4								
G130 ~ G145		129.4 ~ 144.4								
G150 ~ G180	5.7 ±0.13	149.3 ~ 179.3	0.83	0.47	14.2	8.4	1.28	0.92	22.0	16.5
G185 ~ G300		184.3 ~ 299.3								

Tolerances of O-ring bore diameter d_1 are given in the dimensional table of the O-rings.

(2) Extrusion into gap from fitting groove

O-ring extrusion into gap from fitting groove on cylindrical surface is related to the gap amount of the cylindrical surface. Pressure of fluid to be sealed or O-ring hardness also influence.

Fig. 2.5.2 shows the relation between these factors.

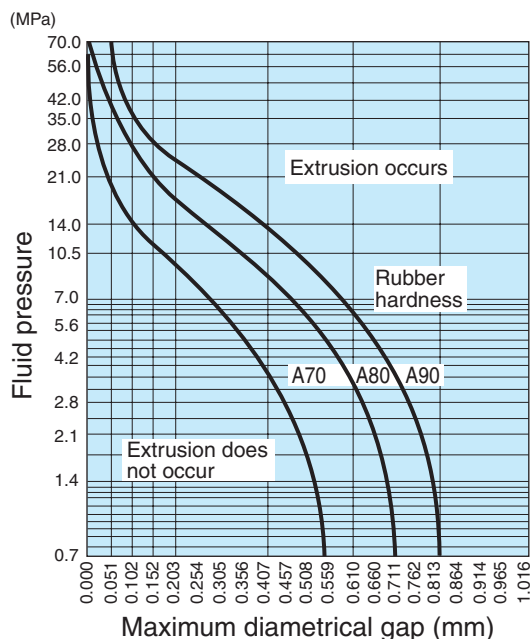

1. Without backup ring
2. Expansion of cylinder inner diameter due to internal pressure of cylinder is not included.
3. These results were obtained after 100 thousand cycles at 2.5 Hz between zero pressure to the pressure specified in the diagram.

Fig. 2.5.2 O-ring extrusion limit values

Expansion of cylinder inner diameter due to internal pressure of cylinder is not taken into consideration for the gap in the diagram above. If any expansion of the cylinder inner diameter may occur, the gap should be 75% of the values shown in the diagram, taking expansion of the gap into consideration.

If the gap is larger than the values shown in the diagram, use backup rings.

(3) Fitting groove surface roughness

Fitting groove surface should be finished as specified in Table 2.5.2 below for the O-ring to have sufficient sealing performance and long service life, and to minimize frictional resistance.

Table 2.5.2 O-ring fitting groove surface roughness

Location	Purpose	Type of pressure		Surface roughness	
		Constant	Pulsating	$\mu\text{m Ra}$	$\mu\text{m Rz}$
Groove side and bottom	Static sealing	Flat surface		3.2	12.5
		Cylindrical surface			
	Dynamic sealing	With backup rings		1.6	6.3
		Without backup ring		0.8	3.2
O-ring sealed contact surface	Static sealing	Constant		1.6	6.3
	Dynamic sealing	Pulsating		0.8	3.2
					0.4
Chamfer area				3.2	12.5

(4) Chamfer of installation location

Provide chamfers on all edges of the cylinder and piston rod to prevent O-ring damage during installation, as shown in Table 2.5.3.

Table 2.5.3 Chamfer of O-ring installed area

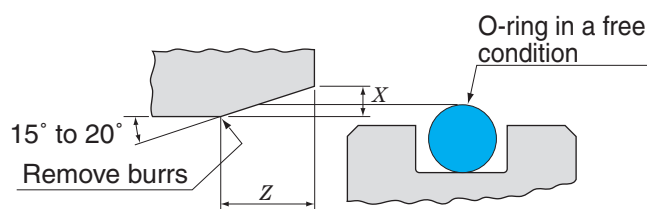

unit : mm

O-ring cross section diameter		X (min.)	Z ¹⁾	
Over	Up to		At 15°	At 20°
—	2.4	0.9	3.4	2.5
2.4	3.5	1.1	4.1	3
3.5	5.7	1.3	4.9	3.6
5.7	8.4	1.5	5.6	4.1

Note 1) Dimension Z is shown when dimension X is minimum.

When O-ring is used on piston seal, do not provide a pressure hole on the area on which the O-ring slides.

If the pressure hole must be installed in the area the O-ring is slid, chamfer the pressure hole (Fig.2.5.3). For the chamfering amount, see the Table 2.5.3.

When the pressure hole is not chamfered:

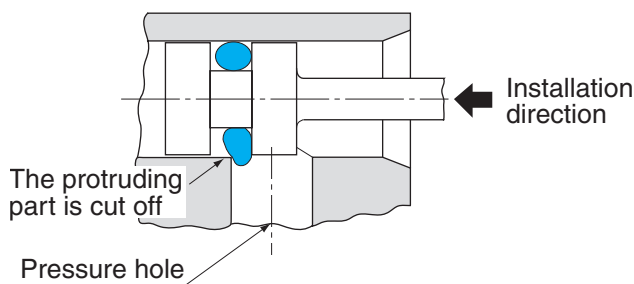

When the pressure hole is chamfered:

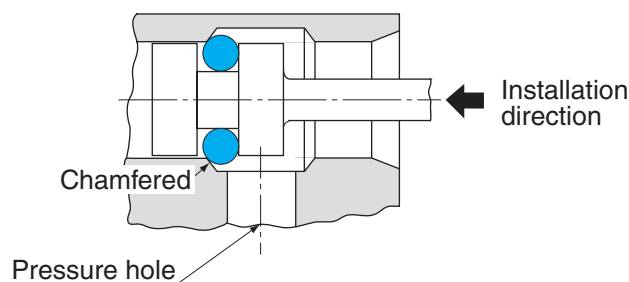

Fig. 2.5.3 Chamfer of pressure-hole edges

(5) Material and surface finishing of fitting groove parts

Cylinder material for dynamic-sealing application should be steel. The most suitable piston rod material is hardened steel.

Soft materials such as aluminum, brass, bronze, Monel metal and soft stainless steel are not suitable as a sliding surface material because of inferior in abrasion resistance.

For static-sealing applications, materials should have sufficient strength to normal operation pressure and should also be resistant to pulsating pressure.

Surface finishing methods to minimize friction are honing, varnishing (roller varnishing), and polishing after hard nickel plating.

Hard-nickel plating is preferable for the application which requires heat resistance, abrasion resistance and low-friction.

Table 2.5.4 shows materials for fitting groove parts and their compatibility

Table 2.5.4 Groove materials and compatibility

Metal	Corrosion resistance	Abrasion resistance	Contamination resistance	Metal protection	O-ring	
					Static sealing	Dynamic sealing
Cadmium	×	×	×	◎	○	○
Chrome	◎	◎	◎	×	○	○
Copper	○	△	×	○	×	×
Gold	◎	△	◎	△	○	×
Iron	×	○	×	○	○	○
Lead	○	×	×	△	○	×
Nickel	○	○	△	○	○	○
Rhodium	◎	◎	◎	△	○	○
Silver	○	△	△	△	○	×
Tin	○	×	○	△	○	×
Zinc	×	×	×	◎	○	×
Remarks	◎ : Excellent △ : Acceptable ○ : Good × : No good				○ : Compatible × : Not compatible	

2.6 O-ring handling

(1) Storage

The following practices are advisable to keep O-ring quality for a long time.

- Do not store where exposed to direct sunlight.
- Store enclosed indoors where temperature is less than 30 °C and humidity is less than 65 %.
- Keep O-rings away from heat or ozone sources.
- O-rings should be sealed completely in packages when stored.
- Do not hang or suspend O-rings on hooks, wires, or strings.

(2) Handling

For good performance of O-ring, pay attention to the points shown below.

- Avoid reuse of used O-rings.
- When installing an O-ring, apply sealing medium (lubricant) to the O-ring and contact surface.
- Install an O-ring in the groove without twisting it.
- Do not clean O-ring equipped machine with cleaning oil or gasoline and protect O-ring from cleaning oil. Otherwise, it may be swollen, causing poor sealing performance.
- If an O-ring passes along the threaded surface or sharp edges on it during installation, provide any mechanism to prevent the O-ring from being damaged.

When fitting an O-ring, insert the cap onto the threaded surface as shown in Fig.2.6.1.

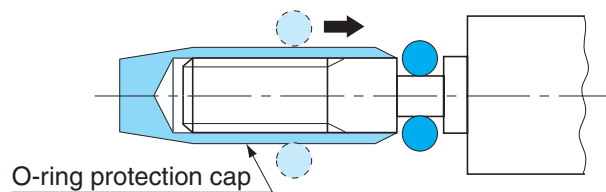

Fig. 2.6.1 O-ring installation jig

2.7 Typical O-ring failures, causes and countermeasures

When leakage is observed, investigate the causes and implement proper countermeasures.

To identify the causes, it is critical to observe the O-ring closely and evaluate the failure in all respects, such as cylinder, piston, and medium to be sealed.

Table 2.7.1 O-ring failures, causes and countermeasures

Ⓓ : Dynamic sealing Ⓔ : Static sealing

Phenomenon	Appearance		Major causes	Countermeasures
	Condition			
Ⓓ Twist	Twisted and deformed		<ul style="list-style-type: none"> 1) Excessive speed 2) Eccentric movements 3) Poor surface finish on sliding face 4) Twisted installation 	<ul style="list-style-type: none"> • Replace with V-packing • Improve accuracy of equipment • Improve sliding surface finish • Install with care (Coat grease.)
Ⓓ Chipping	Partially chipped		<ul style="list-style-type: none"> • Chipped by the bore edge, threads, or sharp corner at installation 	<ul style="list-style-type: none"> • Round all sharp edges • Use an installation jig
Ⓓ and Ⓔ Permanent set	Deformed into the groove's shape		<ul style="list-style-type: none"> 1) Exposure to repeated drastic temperature changes 2) Improper adjustment of temperature, compression, and fluid 	<ul style="list-style-type: none"> • Study alternative rubber materials • Study groove dimensions
Ⓓ Abrasion around the circumference	Worn all round the circumference		<ul style="list-style-type: none"> 1) Poor sliding surface finish 2) Poor lubrication 3) Entry of dust or other foreign materials 	<ul style="list-style-type: none"> • Improve sliding surface finish • Supply sufficient lubrication • Clean thoroughly and use filter etc
Ⓓ and Ⓔ Partial abrasion	Sliding surface is partially worn		<ul style="list-style-type: none"> • There are damages on sliding surface 	<ul style="list-style-type: none"> • Remove damages on sliding surface and improve surface finish
Ⓔ Hardening	Hardened and cracked when bent		<ul style="list-style-type: none"> • Operating temperature is higher than the rubber's heat resistance limit 	<ul style="list-style-type: none"> • Study alternative rubber materials
Ⓔ Swelling	Softened and swollen		<ul style="list-style-type: none"> 1) Improper rubber material 2) Cleaned with fuel oil or other incompatible cleanser 	<ul style="list-style-type: none"> • Study alternative rubber materials • Clean with kerosene
Ⓔ Scratch	Scratch marks are observed		<ul style="list-style-type: none"> • Scratched by a thread or sharp edge at installation 	<ul style="list-style-type: none"> • Use an installation jig
Ⓔ Protrusion	The outside or inside of the ring is cut off partially or around the entire circumference		<ul style="list-style-type: none"> 1) Inappropriate determination of pressure, gap and hardness 2) Due to swelling 	<ul style="list-style-type: none"> • Restudy pressure, gap and hardness • Apply backup rings • Study alternative rubber materials
Ⓔ Tearing	The squeezed portion is cut off or chipped		<ul style="list-style-type: none"> 1) Poor chamfer 2) Groove depth is not sufficient 	<ul style="list-style-type: none"> • Improve chamfer • Restudy groove depth
Ⓔ Crack by ozone	Cracks are observed on all over the ring		<ul style="list-style-type: none"> • Left in the air in a stretched condition 	<ul style="list-style-type: none"> • Do not stretch the ring • Coat grease or oil to the O-ring to avoid contact with air • Study alternative rubber materials

Remark) Dotted line shows original O-ring shape or size.

2.8 O-ring dimensional tables (Contents)

Code	O-ring dimensions (Unit mm)	Application	Page
JIS P		General industrial machines Dynamic/static sealing	102
JIS G		General industrial machines Static sealing	110
JIS S		General industrial machines Static sealing	112
ISO A, B, C, D, E		General industrial machines	114
JASO		Automobiles Dynamic/static sealing	118
AS		Aircraft Static sealing and Dynamic/static sealing	124
BACKUP RING		For dynamic / static sealing of cylindrical surface	132
JIS V		General industrial machines For Vacuum flanges	136

■ O-ring shape and dimensions (unit : mm)

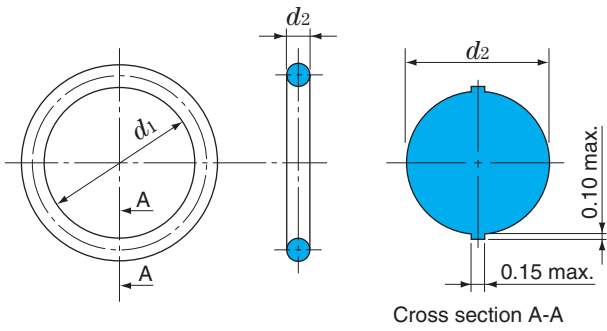

■ Fitting groove dimensions

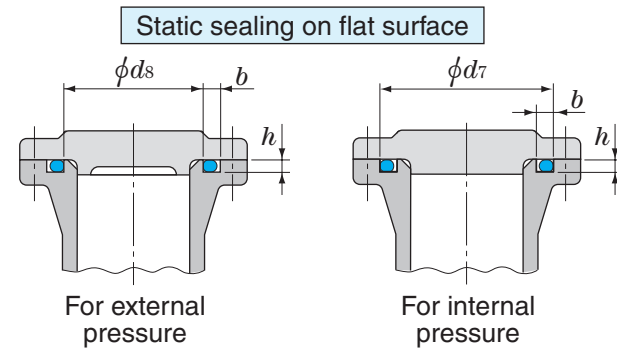

For static sealing on cylindrical surface

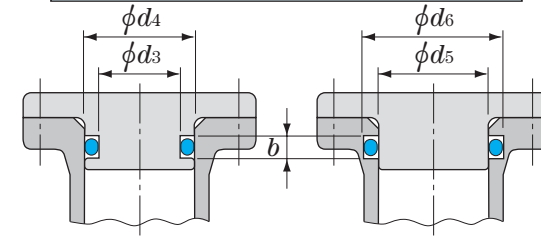

For dynamic sealing

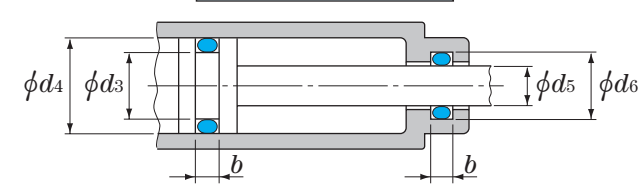

■ Fitting groove design (unit : mm)

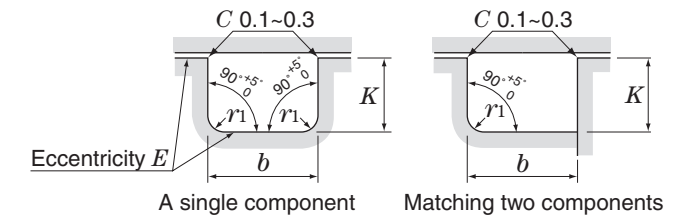

■ Backup rings

(For dynamic sealing and static sealing on cylindrical surface)

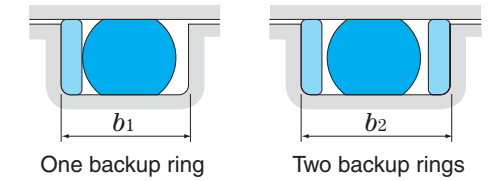

P 3~35

O-ring dimensions		O-ring No.	Groove dimensions for static sealing on flat surface				O-ring No.	Groove dimensions for dynamic sealing and static sealing on cylindrical surface									
Bore dia. d_1 ¹⁾	Cross section dia. d_2		d_8 ²⁾ (for external pressure)	d_7 ²⁾ (for internal pressure)	b ^{+0.25} ₀	h ^{±0.05}		r_1 ^{max.}	d_3, d_5	Reference fitting codes corresponding to d_3 and d_5 tolerances	d_4, d_6	Fitting code ³⁾	b ^{+0.25} ₀ Without backup ring	b_1 ^{+0.25} ₀ With one backup ring	b_2 ^{+0.25} ₀ With two backup rings	E ⁴⁾ max.	r_1 ^{max.}
2.8	± 0.14	P 3 P 4 P 5	3	6.2	2.5	1.4	0.4	3	e9	6	H10	2.5	3.9	5.4	0.05	0.4	
3.8	± 0.14																
4.8	± 0.15																
5.8	± 0.15																
6.8	± 0.16																
7.8	± 0.16																
8.8	± 0.17	P 6 P 7 P 8 P 9 P 10	6	9.2	3.2	1.8	0.4	6	e8	9	H9	3.2	4.4	6.0	0.05	0.4	
6.8	± 0.16																
7.8	± 0.16																
8.8	± 0.17																
9.8	± 0.17																
9.8	± 0.17																
10.8	± 0.18	P 10A P 11 P 11.2 P 12 P 12.5 P 14 P 15 P 16 P 18	10	14	4.7	2.7	0.8	10	e7	14	H9	4.7	6.0	7.8	0.08	0.8	
10.8	± 0.18																
11.0	± 0.18																
11.8	± 0.19																
12.3	± 0.19																
13.8	± 0.19																
14.8	± 0.20	P 20 P 21 P 22 P 22A P 22.4 P 24 P 25 P 25.5 P 26 P 28 P 29 P 29.5 P 30 P 31 P 31.5 P 32 P 34 P 35	20	24	4.7	2.7	0.8	20	e8	24	H9	4.7	6.0	7.8	0.08	0.8	
15.8	± 0.20																
17.8	± 0.21																
19.8	± 0.22																
20.8	± 0.23																
21.8	± 0.24																
21.7	± 0.24	P 22A P 22.4 P 24 P 25 P 25.5 P 26 P 28 P 29 P 29.5 P 30 P 31 P 31.5 P 32 P 34 P 35	22	28	4.7	2.7	0.8	22	e8	28	H9	4.7	6.0	7.8	0.08	0.8	
22.1	± 0.24																
23.7	± 0.24																
24.7	± 0.25																
25.2	± 0.25																
25.7	± 0.26																
27.7	± 0.28	P 28 P 29 P 29.5 P 30 P 31 P 31.5 P 32 P 34 P 35	28	34	4.7	2.7	0.8	28	e7	34	H9	4.7	6.0	7.8	0.08	0.8	
28.7	± 0.29																
29.2	± 0.29																
29.7	± 0.29																
30.7	± 0.30																
31.2	± 0.31																
31.7	± 0.31	P 32 P 34 P 35	32	38	4.7	2.7	0.8	32	e7	38	H9	4.7	6.0	7.8	0.08	0.8	
33.7	± 0.33																
34.7	± 0.34																

Notes 1) The tolerance of bore diameter d_1 shows the specified values in JIS B 2401 for class 1-A, 1-B, 2 and 3 products. For class 4-C products, the tolerance is 1.5 times these values, and for class 4-D products, 1.2 times.
2) For a static sealing application on a flat surface, design the groove according to dimension d_8 for use under external pressure, or according to dimension d_7 for use under internal pressure. An O-ring for use under external pressure can thus have its bore surface in close contact with the inner wall of the groove during use. Likewise an O-ring for use under internal pressure can thus have its circumferential surface in close contact with the outer wall of the groove.

3) The fitting code is corresponding to the d_4 and d_6 tolerances.
4) Eccentricity E means the difference between the maximum value and minimum value of dimension K . The eccentricity can also be defined as double the coaxiality measurement.

O-ring shape and dimensions (unit : mm)

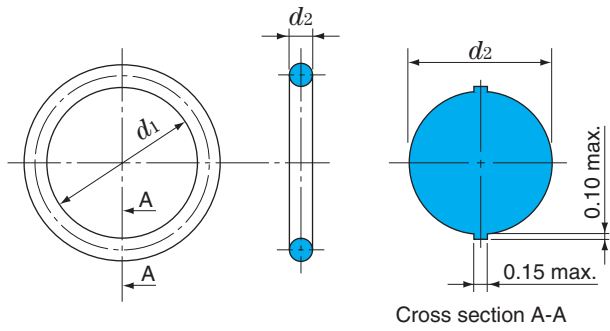

Fitting groove dimensions

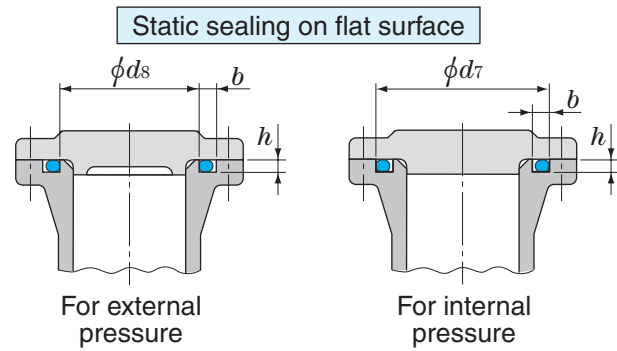

For static sealing on cylindrical surface

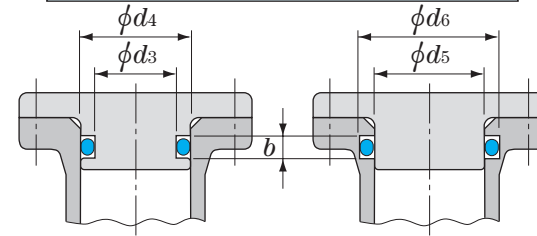

For dynamic sealing

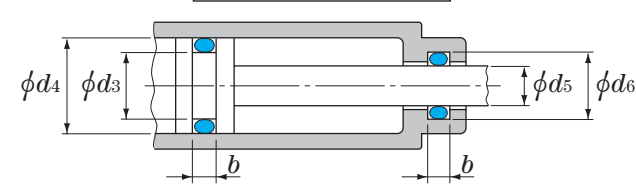

Fitting groove design (unit : mm)

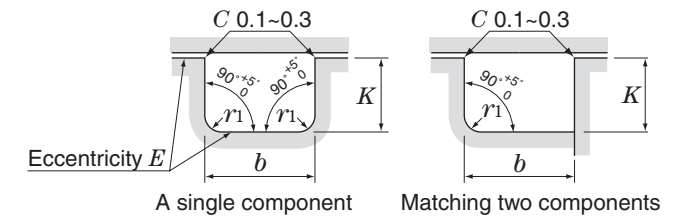

Backup rings (For dynamic sealing and static sealing on cylindrical surface)

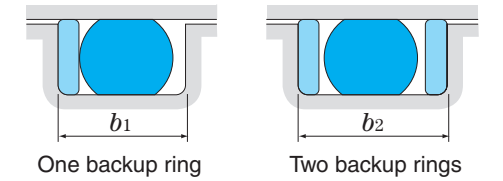

unit : mm

P 35.5~105

O-ring dimensions		O-ring No.	Groove dimensions for static sealing on flat surface					O-ring No.	Groove dimensions for dynamic sealing and static sealing on cylindrical surface																																																																																																																																																																																																																																																																																																																																																																																																																																																																																																																																																																																																																		
Bore dia. d_1 ¹⁾	Cross section dia. d_2		d_s ²⁾ (for external pressure)	d_7 ²⁾ (for internal pressure)	$b + 0.25$ 0	$h \pm 0.05$	r_1 max.		d_3, d_5	Reference fitting codes corresponding to d_3 and d_5 tolerances			d_4, d_6	Fitting code ³⁾	$b + 0.25$ 0 Without backup ring	$b_1 + 0.25$ 0 With one backup ring	$b_2 + 0.25$ 0 With two backup rings	E ⁴⁾ max.	r_1 max.																																																																																																																																																																																																																																																																																																																																																																																																																																																																																																																																																																																																								
35.2	± 0.34	P 35.5 P 36 P 38	35.5	41.5	4.7	2.7	0.8	35.5	0	e7	41.5	H9	4.7	6.0	7.8	0.08	0.8																																																																																																																																																																																																																																																																																																																																																																																																																																																																																																																																																																																																										
35.7	± 0.34		37.7	± 0.37														38.7	± 0.37	39.7	± 0.37	40.7	± 0.38	41.7	± 0.39	43.7	± 0.41	44.7	± 0.41	45.7	± 0.42	47.7	± 0.44	48.7	± 0.45	49.7	± 0.45	47.6	± 0.44	49.6	± 0.45	51.6	± 0.47	52.6	± 0.48	54.6	± 0.49	55.6	± 0.50	57.6	± 0.52	59.6	± 0.53	61.6	± 0.55	62.6	± 0.56	64.6	± 0.57	66.6	± 0.59	69.6	± 0.61	70.6	± 0.62	74.6	± 0.65	79.6	± 0.69	84.6	± 0.73	89.6	± 0.77	94.6	± 0.81	99.6	± 0.84	101.6	± 0.85	104.6	± 0.87	P 42			42	48														P 44			44	50														P 45			45	51														P 46			46	52														P 48			48	54														P 49			49	55														P 50			50	56														P 48A			48	58														P 50A			50	60														P 52			52	62														P 53			53	63														P 55			55	65														P 56			56	66														P 58			58	68														P 60			60	70														P 62			62	72														P 63			63	73														P 65			65	75														P 67			67	77														P 70			70	80														P 71			71	81														P 75			75	85														P 80			80	90														P 85			85	95														P 90			90	100														P 95			95	105														P 100			100	110														P 102			102	112														P 105			105	115													
37.7	± 0.37		38.7	± 0.37														39.7	± 0.37	40.7	± 0.38	41.7	± 0.39	43.7	± 0.41	44.7	± 0.41	45.7	± 0.42	47.7	± 0.44	48.7	± 0.45	49.7	± 0.45	47.6	± 0.44	49.6	± 0.45	51.6	± 0.47	52.6	± 0.48	54.6	± 0.49	55.6	± 0.50	57.6	± 0.52	59.6	± 0.53	61.6	± 0.55	62.6	± 0.56	64.6	± 0.57	66.6	± 0.59	69.6	± 0.61	70.6	± 0.62	74.6	± 0.65	79.6	± 0.69	84.6	± 0.73	89.6	± 0.77	94.6	± 0.81	99.6	± 0.84	101.6	± 0.85	104.6	± 0.87	P 42			42	48														P 44			44	50														P 45			45	51														P 46			46	52														P 48			48	54														P 49			49	55														P 50			50	56														P 48A			48	58														P 50A			50	60														P 52			52	62														P 53			53	63														P 55			55	65														P 56			56	66														P 58			58	68														P 60			60	70														P 62			62	72														P 63			63	73														P 65			65	75														P 67			67	77														P 70			70	80														P 71			71	81														P 75			75	85														P 80			80	90														P 85			85	95														P 90			90	100														P 95			95	105														P 100			100	110														P 102			102	112														P 105			105	115															
38.7	± 0.37		39.7	± 0.37														40.7	± 0.38	41.7	± 0.39	43.7	± 0.41	44.7	± 0.41	45.7	± 0.42	47.7	± 0.44	48.7	± 0.45	49.7	± 0.45	47.6	± 0.44	49.6	± 0.45	51.6	± 0.47	52.6	± 0.48	54.6	± 0.49	55.6	± 0.50	57.6	± 0.52	59.6	± 0.53	61.6	± 0.55	62.6	± 0.56	64.6	± 0.57	66.6	± 0.59	69.6	± 0.61	70.6	± 0.62	74.6	± 0.65	79.6	± 0.69	84.6	± 0.73	89.6	± 0.77	94.6	± 0.81	99.6	± 0.84	101.6	± 0.85	104.6	± 0.87	P 42			42	48														P 44			44	50														P 45			45	51														P 46			46	52														P 48			48	54														P 49			49	55														P 50			50	56														P 48A			48	58														P 50A			50	60														P 52			52	62														P 53			53	63														P 55			55	65														P 56			56	66														P 58			58	68														P 60			60	70														P 62			62	72														P 63			63	73														P 65			65	75														P 67			67	77														P 70			70	80														P 71			71	81														P 75			75	85														P 80			80	90														P 85			85	95														P 90			90	100														P 95			95	105														P 100			100	110														P 102			102	112														P 105			105	115																	
39.7	± 0.37		40.7	± 0.38														41.7	± 0.39	43.7	± 0.41	44.7	± 0.41	45.7	± 0.42	47.7	± 0.44	48.7	± 0.45	49.7	± 0.45	47.6	± 0.44	49.6	± 0.45	51.6	± 0.47	52.6	± 0.48	54.6	± 0.49	55.6	± 0.50	57.6	± 0.52	59.6	± 0.53	61.6	± 0.55	62.6	± 0.56	64.6	± 0.57	66.6	± 0.59	69.6	± 0.61	70.6	± 0.62	74.6	± 0.65	79.6	± 0.69	84.6	± 0.73	89.6	± 0.77	94.6	± 0.81	99.6	± 0.84	101.6	± 0.85	104.6	± 0.87	P 42			42	48														P 44			44	50														P 45			45	51														P 46			46	52														P 48			48	54														P 49			49	55														P 50			50	56														P 48A			48	58														P 50A			50	60														P 52			52	62														P 53			53	63														P 55			55	65														P 56			56	66														P 58			58	68														P 60			60	70														P 62			62	72														P 63			63	73														P 65			65	75														P 67			67	77														P 70			70	80														P 71			71	81														P 75			75	85														P 80			80	90														P 85			85	95														P 90			90	100														P 95			95	105														P 100			100	110														P 102			102	112														P 105			105	115																			
40.7	± 0.38		41.7	± 0.39														43.7	± 0.41	44.7	± 0.41	45.7	± 0.42	47.7	± 0.44	48.7	± 0.45	49.7	± 0.45	47.6	± 0.44	49.6	± 0.45	51.6	± 0.47	52.6	± 0.48	54.6	± 0.49	55.6	± 0.50	57.6	± 0.52	59.6	± 0.53	61.6	± 0.55	62.6	± 0.56	64.6	± 0.57	66.6	± 0.59	69.6	± 0.61	70.6	± 0.62	74.6	± 0.65	79.6	± 0.69	84.6	± 0.73	89.6	± 0.77	94.6	± 0.81	99.6	± 0.84	101.6	± 0.85	104.6	± 0.87	P 42			42	48														P 44			44	50														P 45			45	51														P 46			46	52														P 48			48	54														P 49			49	55														P 50			50	56														P 48A			48	58														P 50A			50	60														P 52			52	62														P 53			53	63														P 55			55	65														P 56			56	66														P 58			58	68														P 60			60	70														P 62			62	72														P 63			63	73														P 65			65	75														P 67			67	77														P 70			70	80														P 71			71	81														P 75			75	85														P 80			80	90														P 85			85	95														P 90			90	100														P 95			95	105														P 100			100	110														P 102			102	112														P 105			105	115																					
41.7	± 0.39		43.7	± 0.41														44.7	± 0.41	45.7	± 0.42	47.7	± 0.44	48.7	± 0.45	49.7	± 0.45	47.6	± 0.44	49.6	± 0.45	51.6	± 0.47	52.6	± 0.48	54.6	± 0.49	55.6	± 0.50	57.6	± 0.52	59.6	± 0.53	61.6	± 0.55	62.6	± 0.56	64.6	± 0.57	66.6	± 0.59	69.6	± 0.61	70.6	± 0.62	74.6	± 0.65	79.6	± 0.69	84.6	± 0.73	89.6	± 0.77	94.6	± 0.81	99.6	± 0.84	101.6	± 0.85	104.6	± 0.87	P 42			42	48														P 44			44	50														P 45			45	51														P 46			46	52														P 48			48	54														P 49			49	55														P 50			50	56														P 48A			48	58														P 50A			50	60														P 52			52	62														P 53			53	63														P 55			55	65														P 56			56	66														P 58			58	68														P 60			60	70														P 62			62	72														P 63			63	73														P 65			65	75														P 67			67	77														P 70			70	80														P 71			71	81														P 75			75	85														P 80			80	90														P 85			85	95														P 90			90	100														P 95			95	105														P 100			100	110														P 102			102	112														P 105			105	115																							
43.7	± 0.41		44.7	± 0.41														45.7	± 0.42	47.7	± 0.44	48.7	± 0.45	49.7	± 0.45	47.6	± 0.44	49.6	± 0.45	51.6	± 0.47	52.6	± 0.48	54.6	± 0.49	55.6	± 0.50	57.6	± 0.52	59.6	± 0.53	61.6	± 0.55	62.6	± 0.56	64.6	± 0.57	66.6	± 0.59	69.6	± 0.61	70.6	± 0.62	74.6	± 0.65	79.6	± 0.69	84.6	± 0.73	89.6	± 0.77	94.6	± 0.81	99.6	± 0.84	101.6	± 0.85	104.6	± 0.87	P 42			42	48														P 44			44	50														P 45			45	51														P 46			46	52														P 48			48	54														P 49			49	55														P 50			50	56														P 48A			48	58														P 50A			50	60														P 52			52	62														P 53			53	63														P 55			55	65														P 56			56	66														P 58			58	68														P 60			60	70														P 62			62	72														P 63			63	73														P 65			65	75														P 67			67	77														P 70			70	80														P 71			71	81														P 75			75	85														P 80			80	90														P 85			85	95														P 90			90	100														P 95			95	105														P 100			100	110														P 102			102	112														P 105			105	115																									
44.7	± 0.41		45.7	± 0.42														47.7	± 0.44	48.7	± 0.45	49.7	± 0.45	47.6	± 0.44	49.6	± 0.45	51.6	± 0.47	52.6	± 0.48	54.6	± 0.49	55.6	± 0.50	57.6	± 0.52	59.6	± 0.53	61.6	± 0.55	62.6	± 0.56	64.6	± 0.57	66.6	± 0.59	69.6	± 0.61	70.6	± 0.62	74.6	± 0.65	79.6	± 0.69	84.6	± 0.73	89.6	± 0.77	94.6	± 0.81	99.6	± 0.84	101.6	± 0.85	104.6	± 0.87	P 42			42	48														P 44			44	50														P 45			45	51														P 46			46	52														P 48			48	54														P 49			49	55														P 50			50	56														P 48A			48	58														P 50A			50	60														P 52			52	62														P 53			53	63														P 55			55	65														P 56			56	66														P 58			58	68														P 60			60	70														P 62			62	72														P 63			63	73														P 65			65	75														P 67			67	77														P 70			70	80														P 71			71	81														P 75			75	85														P 80			80	90														P 85			85	95														P 90			90	100														P 95			95	105														P 100			100	110														P 102			102	112														P 105			105	115																											
45.7	± 0.42		47.7	± 0.44														48.7	± 0.45	49.7	± 0.45	47.6	± 0.44	49.6	± 0.45	51.6	± 0.47	52.6	± 0.48	54.6	± 0.49	55.6	± 0.50	57.6	± 0.52	59.6	± 0.53	61.6	± 0.55	62.6	± 0.56	64.6	± 0.57	66.6	± 0.59	69.6	± 0.61	70.6	± 0.62	74.6	± 0.65	79.6	± 0.69	84.6	± 0.73	89.6	± 0.77	94.6	± 0.81	99.6	± 0.84	101.6	± 0.85	104.6	± 0.87	P 42			42	48														P 44			44	50														P 45			45	51														P 46			46	52														P 48			48	54														P 49			49	55														P 50			50	56														P 48A			48	58														P 50A			50	60														P 52			52	62														P 53			53	63														P 55			55	65														P 56			56	66														P 58			58	68														P 60			60	70														P 62			62	72														P 63			63	73														P 65			65	75														P 67			67	77														P 70			70	80														P 71			71	81														P 75			75	85														P 80			80	90														P 85			85	95														P 90			90	100														P 95			95	105														P 100			100	110														P 102			102	112														P 105			105	115																													
47.7	± 0.44	48.7	± 0.45	49.7	± 0.45	47.6	± 0.44	49.6	± 0.45	51.6	± 0.47	52.6	± 0.48	54.6	± 0.49	55.6	± 0.50	57.6	± 0.52	59.6	± 0.53	61.6	± 0.55	62.6	± 0.56	64.6	± 0.57	66.6	± 0.59	69.6	± 0.61	70.6	± 0.62	74.6	± 0.65	79.6	± 0.69	84.6	± 0.73	89.6	± 0.77	94.6	± 0.81	99.6	± 0.84	101.6	± 0.85	104.6	± 0.87	P 42			42	48														P 44			44	50														P 45			45	51														P 46			46	52														P 48			48	54														P 49			49	55														P 50			50	56														P 48A			48	58														P 50A			50	60														P 52			52	62														P 53			53	63														P 55			55	65														P 56			56	66														P 58			58	68														P 60			60	70														P 62			62	72														P 63			63	73														P 65			65	75														P 67			67	77														P 70			70	80														P 71			71	81														P 75			75	85														P 80			80	90														P 85			85	95														P 90			90	100														P 95			95	105														P 100			100	110														P 102			102	112														P 105			105	115																																													
48.7	± 0.45	49.7	± 0.45	47.6	± 0.44	49.6	± 0.45	51.6	± 0.47	52.6	± 0.48	54.6	± 0.49	55.6	± 0.50	57.6	± 0.52	59.6	± 0.53	61.6	± 0.55	62.6	± 0.56	64.6	± 0.57	66.6	± 0.59	69.6	± 0.61	70.6	± 0.62	74.6	± 0.65	79.6	± 0.69	84.6	± 0.73	89.6	± 0.77	94.6	± 0.81	99.6	± 0.84	101.6	± 0.85	104.6	± 0.87	P 42			42	48														P 44			44	50														P 45			45	51														P 46			46	52														P 48			48	54														P 49			49	55														P 50			50	56														P 48A			48	58														P 50A			50	60														P 52			52	62														P 53			53	63														P 55			55	65														P 56			56	66														P 58			58	68														P 60			60	70														P 62			62	72														P 63			63	73														P 65			65	75														P 67			67	77														P 70			70	80														P 71			71	81														P 75			75	85														P 80			80	90														P 85			85	95														P 90			90	100														P 95			95	105														P 100			100	110														P 102			102	112														P 105			105	115																																															
49.7	± 0.45	47.6	± 0.44	49.6	± 0.45	51.6	± 0.47	52.6	± 0.48	54.6	± 0.49	55.6	± 0.50	57.6	± 0.52	59.6	± 0.53	61.6	± 0.55	62.6	± 0.56	64.6	± 0.57	66.6	± 0.59	69.6	± 0.61	70.6	± 0.62	74.6	± 0.65	79.6	± 0.69	84.6	± 0.73	89.6	± 0.77	94.6	± 0.81	99.6	± 0.84	101.6	± 0.85	104.6	± 0.87	P 42			42	48														P 44			44	50														P 45			45	51														P 46			46	52														P 48			48	54														P 49			49	55														P 50			50	56														P 48A			48	58														P 50A			50	60														P 52			52	62														P 53			53	63														P 55			55	65														P 56			56	66														P 58			58	68														P 60			60	70														P 62			62	72														P 63			63	73														P 65			65	75														P 67			67	77														P 70			70	80														P 71			71	81														P 75			75	85														P 80			80	90														P 85			85	95														P 90			90	100														P 95			95	105														P 100			100	110														P 102			102	112														P 105			105	115																																																	
47.6	± 0.44	49.6	± 0.45	51.6	± 0.47	52.6	± 0.48	54.6	± 0.49	55.6	± 0.50	57.6	± 0.52	59.6	± 0.53	61.6	± 0.55	62.6	± 0.56	64.6	± 0.57	66.6	± 0.59	69.6	± 0.61	70.6	± 0.62	74.6	± 0.65	79.6	± 0.69	84.6	± 0.73	89.6	± 0.77	94.6	± 0.81	99.6	± 0.84	101.6	± 0.85	104.6	± 0.87	P 42			42	48														P 44			44	50														P 45			45	51														P 46			46	52														P 48			48	54														P 49			49	55														P 50			50	56														P 48A			48	58														P 50A			50	60														P 52			52	62														P 53			53	63														P 55			55	65														P 56			56	66														P 58			58	68														P 60			60	70														P 62			62	72														P 63			63	73														P 65			65	75														P 67			67	77														P 70			70	80														P 71			71	81														P 75			75	85														P 80			80	90														P 85			85	95														P 90			90	100														P 95			95	105														P 100			100	110														P 102			102	112														P 105			105	115																																																			
49.6	± 0.45	51.6	± 0.47	52.6	± 0.48	54.6	± 0.49	55.6	± 0.50	57.6	± 0.52	59.6	± 0.53	61.6	± 0.55	62.6	± 0.56	64.6	± 0.57	66.6	± 0.59	69.6	± 0.61	70.6	± 0.62	74.6	± 0.65	79.6	± 0.69	84.6	± 0.73	89.6	± 0.77	94.6	± 0.81	99.6	± 0.84	101.6	± 0.85	104.6	± 0.87	P 42			42	48														P 44			44	50														P 45			45	51														P 46			46	52														P 48			48	54														P 49			49	55														P 50			50	56														P 48A			48	58														P 50A			50	60														P 52			52	62														P 53			53	63														P 55			55	65														P 56			56	66														P 58			58	68														P 60			60	70														P 62			62	72														P 63			63	73														P 65			65	75														P 67			67	77														P 70			70	80														P 71			71	81														P 75			75	85														P 80			80	90														P 85			85	95														P 90			90	100														P 95			95	105														P 100			100	110														P 102			102	112														P 105			105	115																																																					
51.6	± 0.47	52.6	± 0.48	54.6	± 0.49	55.6	± 0.50	57.6	± 0.52	59.6	± 0.53	61.6	± 0.55	62.6	± 0.56	64.6	± 0.57	66.6	± 0.59	69.6	± 0.61	70.6	± 0.62	74.6	± 0.65	79.6	± 0.69	84.6	± 0.73	89.6	± 0.77	94.6	± 0.81	99.6	± 0.84	101.6	± 0.85	104.6	± 0.87	P 42			42	48														P 44			44	50														P 45			45	51														P 46			46	52														P 48			48	54														P 49			49	55														P 50			50	56														P 48A			48	58														P 50A			50	60														P 52			52	62														P 53			53	63														P 55			55	65														P 56			56	66														P 58			58	68														P 60			60	70														P 62			62	72														P 63			63	73														P 65			65	75														P 67			67	77														P 70			70	80														P 71			71	81														P 75			75	85														P 80			80	90														P 85			85	95														P 90			90	100														P 95			95	105														P 100			100	110														P 102			102	112														P 105			105	115																																																							
52.6	± 0.48	54.6	± 0.49	55.6	± 0.50	57.6	± 0.52	59.6	± 0.53	61.6	± 0.55	62.6	± 0.56	64.6	± 0.57	66.6	± 0.59	69.6	± 0.61	70.6	± 0.62	74.6	± 0.65	79.6	± 0.69	84.6	± 0.73	89.6	± 0.77	94.6	± 0.81	99.6	± 0.84	101.6	± 0.85	104.6	± 0.87	P 42			42	48														P 44			44	50														P 45			45	51														P 46			46	52														P 48			48	54														P 49			49	55														P 50			50	56														P 48A			48	58														P 50A			50	60														P 52			52	62														P 53			53	63														P 55			55	65														P 56			56	66														P 58			58	68														P 60			60	70														P 62			62	72														P 63			63	73														P 65			65	75														P 67			67	77														P 70			70	80														P 71			71	81														P 75			75	85														P 80			80	90														P 85			85	95														P 90			90	100														P 95			95	105														P 100			100	110														P 102			102	112														P 105			105	115																																																									
54.6	± 0.49	55.6	± 0.50	57.6	± 0.52	59.6	± 0.53	61.6	± 0.55	62.6	± 0.56	64.6	± 0.57	66.6	± 0.59	69.6	± 0.61	70.6	± 0.62	74.6	± 0.65	79.6	± 0.69	84.6	± 0.73	89.6	± 0.77	94.6	± 0.81	99.6	± 0.84	101.6	± 0.85	104.6	± 0.87	P 42			42	48														P 44			44	50														P 45			45	51														P 46			46	52														P 48			48	54														P 49			49	55														P 50			50	56														P 48A			48	58														P 50A			50	60														P 52			52	62														P 53			53	63														P 55			55	65														P 56			56	66														P 58			58	68														P 60			60	70														P 62			62	72														P 63			63	73														P 65			65	75														P 67			67	77														P 70			70	80														P 71			71	81														P 75			75	85														P 80			80	90														P 85			85	95														P 90			90	100														P 95			95	105														P 100			100	110														P 102			102	112														P 105			105	115																																																											
55.6	± 0.50	57.6	± 0.52	59.6	± 0.53	61.6	± 0.55	62.6	± 0.56	64.6	± 0.57	66.6	± 0.59	69.6	± 0.61	70.6	± 0.62	74.6	± 0.65	79.6	± 0.69	84.6	± 0.73	89.6	± 0.77	94.6	± 0.81	99.6	± 0.84	101.6	± 0.85	104.6	± 0.87	P 42			42	48														P 44			44	50														P 45			45	51														P 46			46	52														P 48			48	54														P 49			49	55														P 50			50	56														P 48A			48	58														P 50A			50	60														P 52			52	62														P 53			53	63														P 55			55	65														P 56			56	66														P 58			58	68														P 60			60	70														P 62			62	72														P 63			63	73														P 65			65	75														P 67			67	77														P 70			70	80														P 71			71	81														P 75			75	85														P 80			80	90														P 85			85	95														P 90			90	100														P 95			95	105														P 100			100	110														P 102			102	112														P 105			105	115																																																													
57.6	± 0.52	59.6	± 0.53	61.6	± 0.55	62.6	± 0.56	64.6	± 0.57	66.6	± 0.59	69.6	± 0.61	70.6	± 0.62	74.6	± 0.65	79.6	± 0.69	84.6	± 0.73	89.6	± 0.77	94.6	± 0.81	99.6	± 0.84	101.6	± 0.85	104.6	± 0.87	P 42			42	48														P 44			44	50														P 45			45	51														P 46			46	52														P 48			48	54														P 49			49	55														P 50			50	56														P 48A			48	58														P 50A			50	60														P 52			52	62														P 53			53	63														P 55			55	65														P 56			56	66														P 58			58	68														P 60			60	70														P 62			62	72														P 63			63	73														P 65			65	75														P 67			67	77														P 70			70	80														P 71			71	81														P 75			75	85														P 80			80	90														P 85			85	95														P 90			90	100														P 95			95	105														P 100			100	110														P 102			102	112														P 105			105	115																																																															
59.6	± 0.53	61.6	± 0.55	62.6	± 0.56	64.6	± 0.57	66.6	± 0.59	69.6	± 0.61	70.6	± 0.62	74.6	± 0.65	79.6	± 0.69	84.6	± 0.73	89.6	± 0.77	94.6	± 0.81	99.6	± 0.84	101.6	± 0.85	104.6	± 0.87	P 42			42	48														P 44			44	50														P 45			45	51														P 46			46	52														P 48			48	54														P 49			49	55														P 50			50	56														P 48A			48	58														P 50A			50	60														P 52			52	62														P 53			53	63														P 55			55	65														P 56			56	66														P 58			58	68														P 60			60	70														P 62			62	72														P 63			63	73														P 65			65	75														P 67			67	77														P 70			70	80														P 71			71	81														P 75			75	85														P 80			80	90														P 85			85	95														P 90			90	100														P 95			95	105														P 100			100	110														P 102			102	112														P 105			105	115																																																																	
61.6	± 0.55	62.6	± 0.56	64.6	± 0.57	66.6	± 0.59	69.6	± 0.61	70.6	± 0.62	74.6	± 0.65	79.6	± 0.69	84.6	± 0.73	89.6	± 0.77	94.6	± 0.81	99.6	± 0.84	101.6	± 0.85	104.6	± 0.87	P 42			42	48														P 44			44	50														P 45			45	51														P 46			46	52														P 48			48	54														P 49			49	55														P 50			50	56														P 48A			48	58														P 50A			50	60														P 52			52	62														P 53			53	63														P 55			55	65														P 56			56	66														P 58			58	68														P 60			60	70														P 62			62	72														P 63			63	73														P 65			65	75														P 67			67	77														P 70			70	80														P 71			71	81														P 75			75	85														P 80			80	90														P 85			85	95														P 90			90	100														P 95			95	105														P 100			100	110														P 102			102	112														P 105			105	115																																																																			
62.6	± 0.56	64.6	± 0.57	66.6	± 0.59	69.6	± 0.61	70.6	± 0.62	74.6	± 0.65	79.6	± 0.69	84.6	± 0.73	89.6	± 0.77	94.6	± 0.81	99.6	± 0.84	101.6	± 0.85	104.6	± 0.87	P 42			42	48														P 44			44	50														P 45			45	51														P 46			46	52														P 48			48	54														P 49			49	55														P 50			50	56														P 48A			48	58														P 50A			50	60														P 52			52	62														P 53			53	63														P 55			55	65														P 56			56	66														P 58			58	68														P 60			60	70														P 62			62	72														P 63			63	73														P 65			65	75														P 67			67	77														P 70			70	80														P 71			71	81														P 75			75	85														P 80			80	90														P 85			85	95														P 90			90	100														P 95			95	105														P 100			100	110														P 102			102	112														P 105			105	115																																																																					
64.6	± 0.57	66.6	± 0.59	69.6	± 0.61	70.6	± 0.62	74.6	± 0.65	79.6	± 0.69	84.6	± 0.73	89.6	± 0.77	94.6	± 0.81	99.6	± 0.84	101.6	± 0.85	104.6	± 0.87	P 42			42	48														P 44			44	50														P 45			45	51														P 46			46	52														P 48			48	54														P 49			49	55														P 50			50	56														P 48A			48	58														P 50A			50	60														P 52			52	62														P 53			53	63														P 55			55	65														P 56			56	66														P 58			58	68														P 60			60	70														P 62			62	72														P 63			63	73														P 65			65	75														P 67			67	77														P 70			70	80														P 71			71	81														P 75			75	85														P 80			80	90														P 85			85	95														P 90			90	100														P 95			95	105														P 100			100	110														P 102			102	112														P 105			105	115																																																																							
66.6	± 0.59	69.6	± 0.61	70.6	± 0.62	74.6	± 0.65	79.6	± 0.69	84.6	± 0.73	89.6	± 0.77	94.6	± 0.81	99.6	± 0.84	101.6	± 0.85	104.6	± 0.87	P 42			42	48														P 44			44	50														P 45			45	51														P 46			46	52														P 48			48	54														P 49			49	55														P 50			50	56														P 48A			48	58														P 50A			50	60														P 52			52	62														P 53			53	63														P 55			55	65														P 56			56	66														P 58			58	68														P 60			60	70														P 62			62	72														P 63			63	73														P 65			65	75														P 67			67	77														P 70			70	80														P 71			71	81														P 75			75	85														P 80			80	90														P 85			85	95														P 90			90	100														P 95			95	105														P 100			100	110														P 102			102	112														P 105			105	115																																																																									
69.6	± 0.61	70.6	± 0.62	74.6	± 0.65	79.6	± 0.69	84.6	± 0.73	89.6	± 0.77	94.6	± 0.81	99.6	± 0.84	101.6	± 0.85	104.6	± 0.87	P 42			42	48														P 44			44	50														P 45			45	51														P 46			46	52														P 48			48	54														P 49			49	55														P 50			50	56														P 48A			48	58														P 50A			50	60														P 52			52	62														P 53			53	63														P 55			55	65														P 56			56	66														P 58			58	68														P 60			60	70														P 62			62	72														P 63			63	73														P 65			65	75														P 67			67	77														P 70			70	80														P 71			71	81														P 75			75	85														P 80			80	90														P 85			85	95														P 90			90	100														P 95			95	105														P 100			100	110														P 102			102	112														P 105			105	115																																																																											
70.6	± 0.62	74.6	± 0.65	79.6	± 0.69	84.6	± 0.73	89.6	± 0.77	94.6	± 0.81	99.6	± 0.84	101.6	± 0.85	104.6	± 0.87	P 42			42	48														P 44			44	50														P 45			45	51														P 46			46	52														P 48			48	54														P 49			49	55														P 50			50	56														P 48A			48	58														P 50A			50	60														P 52			52	62														P 53			53	63														P 55			55	65														P 56			56	66														P 58			58	68														P 60			60	70														P 62			62	72														P 63			63	73														P 65			65	75														P 67			67	77														P 70			70	80														P 71			71	81														P 75			75	85														P 80			80	90														P 85			85	95														P 90			90	100														P 95			95	105														P 100			100	110														P 102			102	112														P 105			105	115																																																																													
74.6	± 0.65	79.6	± 0.69	84.6	± 0.73	89.6	± 0.77	94.6	± 0.81	99.6	± 0.84	101.6	± 0.85	104.6	± 0.87	P 42			42	48														P 44			44	50														P 45			45	51														P 46			46	52														P 48			48	54														P 49			49	55														P 50			50	56														P 48A			48	58														P 50A			50	60														P 52			52	62														P 53			53	63														P 55			55	65														P 56			56	66														P 58			58	68														P 60			60	70														P 62			62	72														P 63			63	73														P 65			65	75														P 67			67	77														P 70			70	80														P 71			71	81														P 75			75	85														P 80			80	90														P 85			85	95														P 90			90	100														P 95			95	105														P 100			100	110														P 102			102	112														P 105			105	115																																																																															
79.6	± 0.69	84.6	± 0.73	89.6	± 0.77	94.6	± 0.81	99.6	± 0.84	101.6	± 0.85	104.6	± 0.87	P 42			42	48														P 44			44	50														P 45			45	51														P 46			46	52														P 48			48	54														P 49			49	55														P 50			50	56														P 48A			48	58														P 50A			50	60														P 52			52	62														P 53			53	63														P 55			55	65														P 56			56	66														P 58			58	68														P 60			60	70														P 62			62	72														P 63			63	73														P 65			65	75														P 67			67	77														P 70			70	80														P 71			71	81														P 75			75	85														P 80			80	90														P 85			85	95														P 90			90	100														P 95			95	105														P 100			100	110														P 102			102	112														P 105			105	115																																																																																	
84.6	± 0.73	89.6	± 0.77	94.6	± 0.81	99.6	± 0.84	101.6	± 0.85	104.6	± 0.87	P 42			42	48														P 44			44	50														P 45			45	51														P 46			46	52														P 48			48	54														P 49			49	55														P 50			50	56														P 48A			48	58														P 50A			50	60														P 52			52	62														P 53			53	63														P 55			55	65														P 56			56	66														P 58			58	68														P 60			60	70														P 62			62	72														P 63			63	73														P 65			65	75														P 67			67	77														P 70			70	80														P 71			71	81														P 75			75	85														P 80			80	90														P 85			85	95														P 90			90	100														P 95			95	105														P 100			100	110														P 102			102	112														P 105			105	115																																																																																			
89.6	± 0.77	94.6	± 0.81	99.6	± 0.84	101.6	± 0.85	104.6	± 0.87	P 42			42	48														P 44			44	50														P 45			45	51														P 46			46	52														P 48			48	54														P 49			49	55														P 50			50	56														P 48A			48	58														P 50A			50	60														P 52			52	62														P 53			53	63														P 55			55	65														P 56			56	66														P 58			58	68														P 60			60	70														P 62			62	72														P 63			63	73														P 65			65	75														P 67			67	77														P 70			70	80														P 71			71	81														P 75			75	85														P 80			80	90														P 85			85	95														P 90			90	100														P 95			95	105														P 100			100	110														P 102			102	112														P 105			105	115																																																																																					
94.6	± 0.81	99.6	± 0.84	101.6	± 0.85	104.6	± 0.87	P 42			42	48														P 44			44	50														P 45			45	51														P 46			46	52														P 48			48	54														P 49			49	55														P 50			50	56														P 48A			48	58														P 50A			50	60														P 52			52	62														P 53			53	63														P 55			55	65														P 56			56	66														P 58			58	68														P 60			60	70														P 62			62	72														P 63			63	73														P 65			65	75														P 67			67	77														P 70			70	80														P 71			71	81														P 75			75	85														P 80			80	90														P 85			85	95														P 90			90	100														P 95			95	105														P 100			100	110														P 102			102	112														P 105			105	115																																																																																							
99.6	± 0.84	101.6	± 0.85	104.6	± 0.87	P 42			42	48														P 44			44	50														P 45			45	51														P 46			46	52														P 48			48	54														P 49			49	55														P 50			50	56														P 48A			48	58														P 50A			50	60														P 52			52	62														P 53			53	63														P 55			55	65														P 56			56	66														P 58			58	68														P 60			60	70														P 62			62	72														P 63			63	73														P 65			65	75														P 67			67	77														P 70			70	80														P 71			71	81														P 75			75	85														P 80			80	90														P 85			85	95														P 90			90	100														P 95			95	105														P 100			100	110														P 102			102	112														P 105			105	115																																																																																									
101.6	± 0.85	104.6	± 0.87	P 42			42	48														P 44			44	50														P 45			45	51														P 46			46	52														P 48			48	54														P 49			49	55														P 50			50	56														P 48A			48	58														P 50A			50	60														P 52			52	62														P 53			53	63														P 55			55	65														P 56			56	66														P 58			58	68														P 60			60	70														P 62			62	72														P 63			63	73														P 65			65	75														P 67			67	77														P 70			70	80														P 71			71	81														P 75			75	85														P 80			80	90														P 85			85	95														P 90			90	100														P 95			95	105														P 100			100	110														P 102			102	112														P 105			105	115																																																																																											
104.6	± 0.87	P 42			42	48														P 44			44	50														P 45			45	51														P 46			46	52														P 48			48	54														P 49			49	55														P 50			50	56														P 48A			48	58														P 50A			50	60														P 52			52	62														P 53			53	63														P 55			55	65														P 56			56	66														P 58			58	68														P 60			60	70														P 62			62	72														P 63			63	73														P 65			65	75														P 67			67	77														P 70			70	80														P 71			71	81														P 75			75	85														P 80			80	90														P 85			85	95														P 90			90	100														P 95			95	105														P 100			100	110														P 102			102	112														P 105			105	115																																																																																													
P 42			42	48																																																																																																																																																																																																																																																																																																																																																																																																																																																																																																																																																																																																																							
P 44			44	50																																																																																																																																																																																																																																																																																																																																																																																																																																																																																																																																																																																																																							
P 45			45	51																																																																																																																																																																																																																																																																																																																																																																																																																																																																																																																																																																																																																							
P 46			46	52																																																																																																																																																																																																																																																																																																																																																																																																																																																																																																																																																																																																																							
P 48			48	54																																																																																																																																																																																																																																																																																																																																																																																																																																																																																																																																																																																																																							
P 49			49	55																																																																																																																																																																																																																																																																																																																																																																																																																																																																																																																																																																																																																							
P 50			50	56																																																																																																																																																																																																																																																																																																																																																																																																																																																																																																																																																																																																																							
P 48A			48	58																																																																																																																																																																																																																																																																																																																																																																																																																																																																																																																																																																																																																							
P 50A			50	60																																																																																																																																																																																																																																																																																																																																																																																																																																																																																																																																																																																																																							
P 52			52	62																																																																																																																																																																																																																																																																																																																																																																																																																																																																																																																																																																																																																							
P 53			53	63																																																																																																																																																																																																																																																																																																																																																																																																																																																																																																																																																																																																																							
P 55			55	65																																																																																																																																																																																																																																																																																																																																																																																																																																																																																																																																																																																																																							
P 56			56	66																																																																																																																																																																																																																																																																																																																																																																																																																																																																																																																																																																																																																							
P 58			58	68																																																																																																																																																																																																																																																																																																																																																																																																																																																																																																																																																																																																																							
P 60			60	70																																																																																																																																																																																																																																																																																																																																																																																																																																																																																																																																																																																																																							
P 62			62	72																																																																																																																																																																																																																																																																																																																																																																																																																																																																																																																																																																																																																							
P 63			63	73																																																																																																																																																																																																																																																																																																																																																																																																																																																																																																																																																																																																																							
P 65			65	75																																																																																																																																																																																																																																																																																																																																																																																																																																																																																																																																																																																																																							
P 67			67	77																																																																																																																																																																																																																																																																																																																																																																																																																																																																																																																																																																																																																							
P 70			70	80																																																																																																																																																																																																																																																																																																																																																																																																																																																																																																																																																																																																																							
P 71			71	81																																																																																																																																																																																																																																																																																																																																																																																																																																																																																																																																																																																																																							
P 75			75	85																																																																																																																																																																																																																																																																																																																																																																																																																																																																																																																																																																																																																							
P 80			80	90																																																																																																																																																																																																																																																																																																																																																																																																																																																																																																																																																																																																																							
P 85			85	95																																																																																																																																																																																																																																																																																																																																																																																																																																																																																																																																																																																																																							
P 90			90	100																																																																																																																																																																																																																																																																																																																																																																																																																																																																																																																																																																																																																							
P 95			95	105																																																																																																																																																																																																																																																																																																																																																																																																																																																																																																																																																																																																																							
P 100			100	110																																																																																																																																																																																																																																																																																																																																																																																																																																																																																																																																																																																																																							
P 102			102	112																																																																																																																																																																																																																																																																																																																																																																																																																																																																																																																																																																																																																							
P 105			105	115																																																																																																																																																																																																																																																																																																																																																																																																																																																																																																																																																																																																																							

Notes 1) The tolerance of bore diameter d_1 shows the specified values in JIS B 2401 for class 1-A, 1-B, 2 and 3 products. For class 4-C products, the tolerance is 1.5 times these values, and for class 4-D products, 1.2 times.
 2) For a static sealing application on a flat surface, design the groove according to dimension d_s for use under external pressure, or according to dimension d_7 for use under internal pressure. An O-ring for use under external pressure can thus have its bore surface in close contact with the inner wall of the groove during use. Likewise an O-ring for use under internal pressure can thus have its circumferential surface in close contact with the outer wall of the groove.

3) The fitting code is corresponding to the d_4 and d_6 tolerances.
 4) Eccentricity E means the difference between the maximum value and minimum value of dimension K . The eccentricity can also be defined as double the coaxiality measurement.

O-ring shape and dimensions (unit : mm)

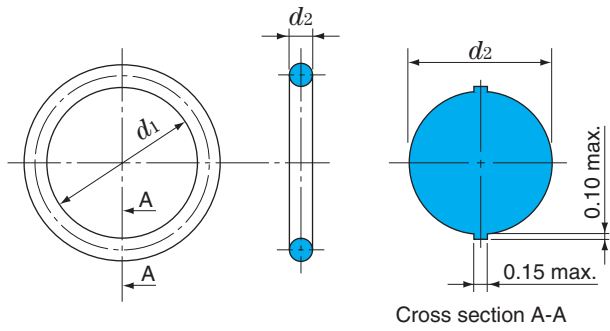

Fitting groove dimensions

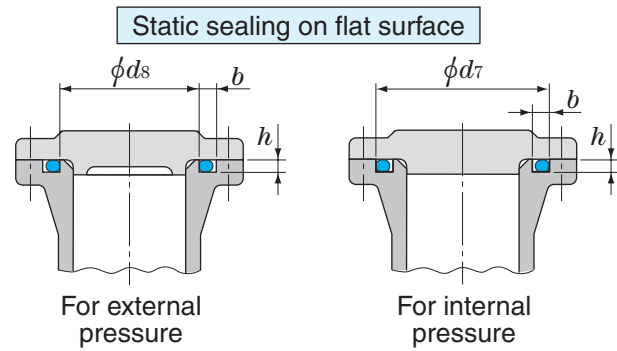

For static sealing on cylindrical surface

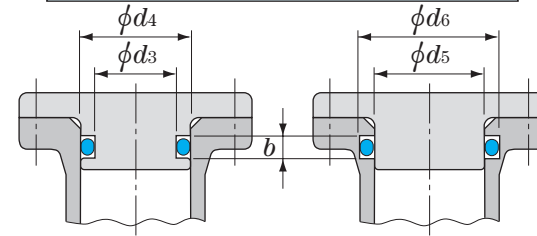

For dynamic sealing

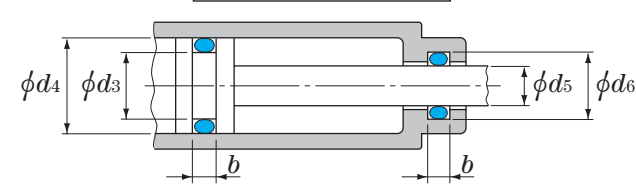

Fitting groove design (unit : mm)

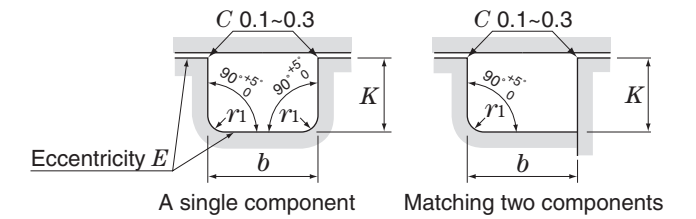

Backup rings (For dynamic sealing and static sealing on cylindrical surface)

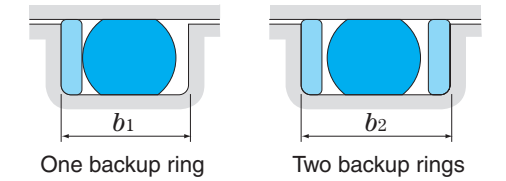

P 110~260

O-ring dimensions		O-ring No.	Groove dimensions for static sealing on flat surface				O-ring No.	Groove dimensions for dynamic sealing and static sealing on cylindrical surface										
Bore dia. d_1 ¹⁾	Cross section dia. d_2		d_s ²⁾ (for external pressure)	d_7 ²⁾ (for internal pressure)	$b + 0.25$ 0	$h \pm 0.05$		r_1 max.	d_3, d_5	Reference fitting codes corresponding to d_3 and d_5 tolerances	d_4, d_6	Fitting code ³⁾	$b + 0.25$ 0 Without backup ring	$b_1 + 0.25$ 0 With one backup ring	$b_2 + 0.25$ 0 With two backup rings	E ⁴⁾ max.	r_1 max.	
109.6	± 0.91	P 110 P 112 P 115	110	120	7.5	4.6	0.8	110	f8	e6	120	H9	7.5	9.0	11.5	0.10	0.8	
111.6	± 0.92																	
114.6	± 0.94																	
119.6	± 0.98		P 120 P 125 P 130	120														130
124.6	± 1.01																	
129.6	± 1.05																	
131.6	± 1.06																	
134.6	± 1.09		P 132 P 135 P 140	132														142
139.6	± 1.12																	
144.6	± 1.16																	
149.6	± 1.19																	
149.5	± 1.19	P 150A P 155 P 160	150	165														
154.5	± 1.23																	
159.5	± 1.26																	
164.5	± 1.30																	
169.5	± 1.33	P 165 P 170 P 175	165	180														
174.5	± 1.37																	
179.5	± 1.40																	
184.5	± 1.44																	
189.5	± 1.48	P 180 P 185 P 190	180	195														
194.5	± 1.51																	
199.5	± 1.55																	
204.5	± 1.58																	
208.5	± 1.61	P 209 P 210 P 215	209	224														
209.5	± 1.62																	
214.5	± 1.65																	
219.5	± 1.68																	
224.5	± 1.71	P 220 P 225 P 230	220	235														
229.5	± 1.75																	
234.5	± 1.78																	
239.5	± 1.81																	
244.5	± 1.84	P 235 P 240 P 245	235	250														
249.5	± 1.88																	
254.5	± 1.91																	
259.5	± 1.94																	
250	± 1.94	P 250 P 255 P 260	250	265														
255	± 1.94																	
260	± 1.94																	
265	± 1.94																	

Notes 1) The tolerance of bore diameter d_1 shows the specified values in JIS B 2401 for class 1-A, 1-B, 2 and 3 products. For class 4-C products, the tolerance is 1.5 times these values, and for class 4-D products, 1.2 times.
2) For a static sealing application on a flat surface, design the groove according to dimension d_s for use under external pressure, or according to dimension d_7 for use under internal pressure. An O-ring for use under external pressure can thus have its bore surface in close contact with the inner wall of the groove during use. Likewise an O-ring for use under internal pressure can thus have its circumferential surface in close contact with the outer wall of the groove.

3) The fitting code is corresponding to the d_4 and d_6 tolerances.
4) Eccentricity E means the difference between the maximum value and minimum value of dimension K . The eccentricity can also be defined as double the coaxiality measurement.

O-ring shape and dimensions (unit : mm)

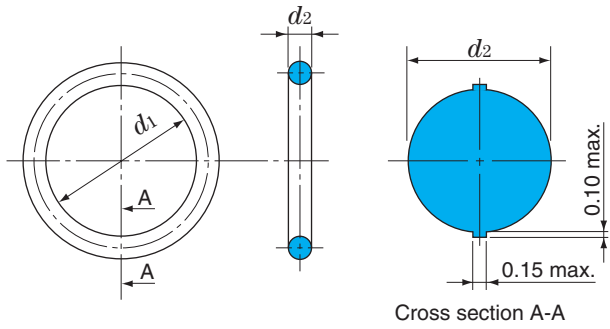

Fitting groove dimensions

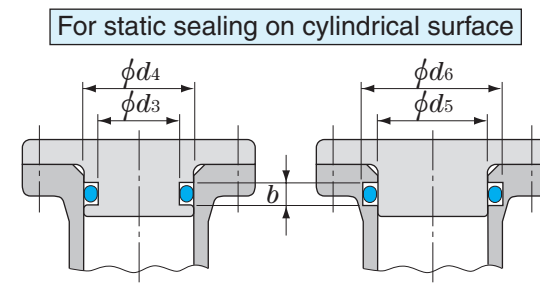
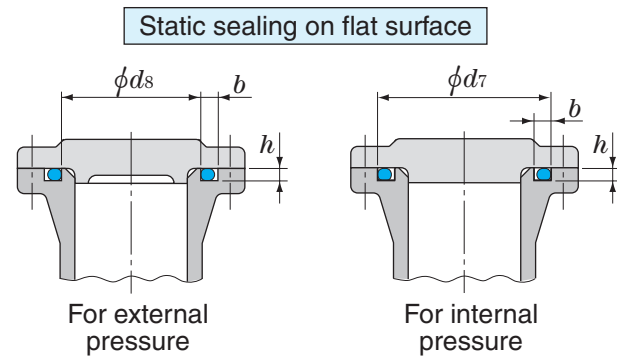

Fitting groove design (unit : mm)

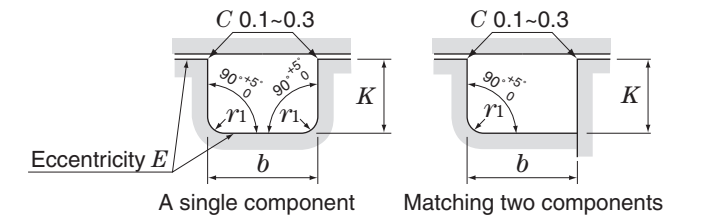

Backup rings (For static sealing on cylindrical surface)

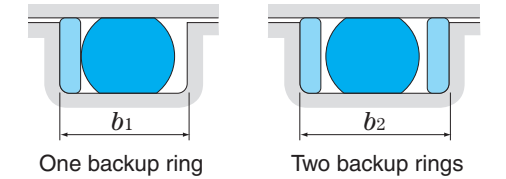

G 25~300

O-ring dimensions		O-ring No.	Groove dimensions for static sealing on flat surface				O-ring No.	Groove dimensions for static sealing on cylindrical surface																					
Bore dia. d_1 ¹⁾	Cross section dia. d_2		d_8 ²⁾ (for external pressure)	d_7 ²⁾ (for internal pressure)	$b + 0.25$ 0	$h \pm 0.05$		r_1 max.	d_3, d_5	Reference fitting codes corresponding to d_3 and d_5 tolerances	d_4, d_6	Fitting code	$b + 0.25$ 0 Without backup ring	$b_1 + 0.25$ 0 With one backup ring	$b_2 + 0.25$ 0 With two backup rings	E ⁴⁾ max.	r_1 max.												
24.4 ± 0.25	3.1 ± 0.10	G 25	25	30	4.1	2.4	0.7	25	f8	e9	30	4.1	5.6	7.3	0.08	0.7													
29.4 ± 0.29		G 30	30	35													35	35	35	35	35	35	35	35	35	35	35	35	35
34.4 ± 0.33		G 35	35	40													40	40	40	40	40	40	40	40	40	40	40	40	40
39.4 ± 0.37		G 40	40	45													45	45	45	45	45	45	45	45	45	45	45	45	45
44.4 ± 0.41		G 45	45	50													50	50	50	50	50	50	50	50	50	50	50	50	50
49.4 ± 0.45		G 50	50	55													55	55	55	55	55	55	55	55	55	55	55	55	55
54.4 ± 0.49		G 55	55	60													60	60	60	60	60	60	60	60	60	60	60	60	60
59.4 ± 0.53		G 60	60	65													65	65	65	65	65	65	65	65	65	65	65	65	65
64.4 ± 0.57		G 65	65	70													70	70	70	70	70	70	70	70	70	70	70	70	70
69.4 ± 0.61		G 70	70	75													75	75	75	75	75	75	75	75	75	75	75	75	75
74.4 ± 0.65		G 75	75	80													80	80	80	80	80	80	80	80	80	80	80	80	80
79.4 ± 0.69		G 80	80	85													85	85	85	85	85	85	85	85	85	85	85	85	85
84.4 ± 0.73		G 85	85	90													90	90	90	90	90	90	90	90	90	90	90	90	90
89.4 ± 0.77		G 90	90	95													95	95	95	95	95	95	95	95	95	95	95	95	95
94.4 ± 0.81		G 95	95	100													100	100	100	100	100	100	100	100	100	100	100	100	100
99.4 ± 0.85	G 100	100	105	105	105	105	105	105	105	105	105	105	105	105	105	105													
104.4 ± 0.87	G 105	105	110	110	110	110	110	110	110	110	110	110	110	110	110	110													
109.4 ± 0.91	G 110	110	115	115	115	115	115	115	115	115	115	115	115	115	115	115													
114.4 ± 0.94	G 115	115	120	120	120	120	120	120	120	120	120	120	120	120	120	120													
119.4 ± 0.98	G 120	120	125	125	125	125	125	125	125	125	125	125	125	125	125	125													
124.4 ± 1.01	G 125	125	130	130	130	130	130	130	130	130	130	130	130	130	130	130													
129.4 ± 1.05	G 130	130	135	135	135	135	135	135	135	135	135	135	135	135	135	135													
134.4 ± 1.08	G 135	135	140	140	140	140	140	140	140	140	140	140	140	140	140	140													
139.4 ± 1.12	G 140	140	145	145	145	145	145	145	145	145	145	145	145	145	145	145													
144.4 ± 1.16	G 145	145	150	150	150	150	150	150	150	150	150	150	150	150	150	150													
149.3 ± 1.19	G 150	150	155	155	155	155	155	155	155	155	155	155	155	155	155	155													
154.3 ± 1.23	G 155	155	160	160	160	160	160	160	160	160	160	160	160	160	160	160													
159.3 ± 1.26	G 160	160	165	165	165	165	165	165	165	165	165	165	165	165	165	165													
164.3 ± 1.30	G 165	165	170	170	170	170	170	170	170	170	170	170	170	170	170	170													
169.3 ± 1.33	G 170	170	175	175	175	175	175	175	175	175	175	175	175	175	175	175													
174.3 ± 1.37	G 175	175	180	180	180	180	180	180	180	180	180	180	180	180	180	180													
179.3 ± 1.40	G 180	180	185	185	185	185	185	185	185	185	185	185	185	185	185	185													
184.3 ± 1.44	G 185	185	190	190	190	190	190	190	190	190	190	190	190	190	190	190													
189.3 ± 1.47	G 190	190	195	195	195	195	195	195	195	195	195	195	195	195	195	195													
194.3 ± 1.51	G 195	195	200	200	200	200	200	200	200	200	200	200	200	200	200	200													
199.3 ± 1.55	G 200	200	205	205	205	205	205	205	205	205	205	205	205	205	205	205													
209.3 ± 1.61	G 210	210	210	210	210	210	210	210	210	210	210	210	210	210	210	210													
219.3 ± 1.68	G 220	220	215	215	215	215	215	215	215	215	215	215	215	215	215	215													
229.3 ± 1.73	G 230	230	220	220	220	220	220	220	220	220	220	220	220	220	220	220													
239.3 ± 1.81	G 240	240	225	225	225	225	225	225	225	225	225	225	225	225	225	225													
249.3 ± 1.88	G 250	250	230	230	230	230	230	230	230	230	230	230	230	230	230	230													
259.3 ± 1.94	G 260	260	235	235	235	235	235	235	235	235	235	235	235	235	235	235													
269.3 ± 2.01	G 270	270	240	240	240	240	240	240	240	240	240	240	240	240	240	240													
279.3 ± 2.07	G 280	280	245	245	245	245	245	245	245	245	245	245	245	245	245	245													
289.3 ± 2.14	G 290	290	250	250	250	250	250	250	250	250	250	250	250	250	250	250													
299.3 ± 2.20	G 300	300	255	255	255	255	255	255	255	255	255	255	255	255	255	255													

Notes 1) The tolerance of bore diameter d_1 shows the specified values in JIS B 2401 for class 1-A, 1-B, 2 and 3 products. For class 4-C products, the tolerance is 1.5 times these values, and for class 4-D products, 1.2 times.
2) For a static sealing application on a flat surface, design the groove according to dimension d_8 for use under external pressure, or according to dimension d_7 for use under internal pressure. An O-ring for use under external pressure can thus have its bore surface in close contact with the inner wall of the groove during use. Likewise an O-ring for use under internal pressure can thus have its circumferential surface in close contact with the outer wall of the groove.

3) The fitting code is corresponding to the d_4 and d_6 tolerances.
4) Eccentricity E means the difference between the maximum value and minimum value of dimension K . The eccentricity can also be defined as double the coaxiality measurement.

S

3~150

Slim Series (for Static Sealing)

Material : JIS classes 1-A and 4-D

■ O-ring shape and dimensions (unit : mm)

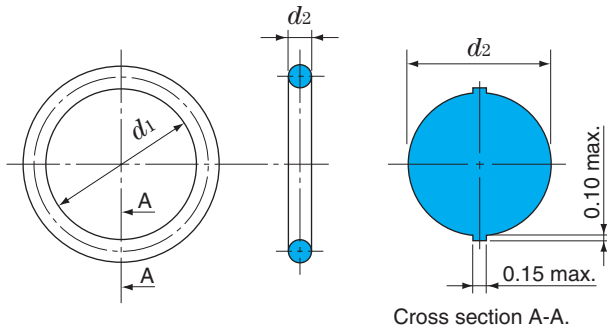

■ Fitting groove dimensions

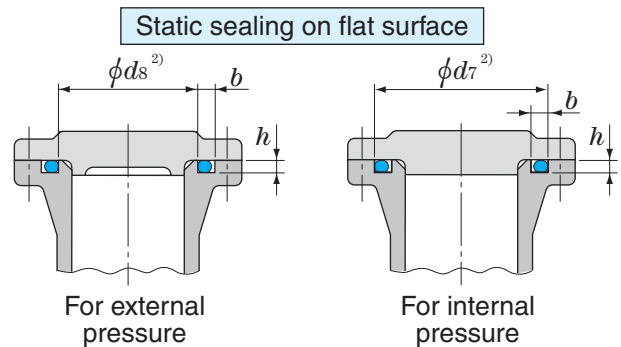

S 3~40

unit : mm

O-ring dimensions		O-ring No.	Groove dimensions							
Bore dia. d_1 ¹⁾	Cross section dia. d_2		d_3, d_5, d_8 ²⁾ $\begin{matrix} 0 \\ -0.05 \end{matrix}$	d_4, d_6 $\begin{matrix} +0.05 \\ 0 \end{matrix}$	d_7 ²⁾	b $\begin{matrix} +0.25 \\ 0 \end{matrix}$	h $\begin{matrix} 0 \\ -0.1 \end{matrix}$			
2.5	± 0.15	S 3	3	5	5.3	2.5	1.0			
3.5		S 4	4	6	6.3					
4.5		S 5	5	7	7.3					
5.5		S 6	6	8	8.3					
6.5		S 7	7	9	9.3					
7.5		S 8	8	10	10.3					
8.5		S 9	9	11	11.3					
9.5		S 10	10	12	12.3					
10.7		S 11.2	11.2	13.2	13.5					
11.5		S 12	12	14	14.3					
12.0		S 12.5	12.5	14.5	14.8					
13.5		S 14	14	16	16.3					
14.5		S 15	15	17	17.3					
15.5		S 16	16	18	18.3					
17.5		S 18	18	20	20.3					
19.5		S 20	20	22	22.3					
21.5		S 22	22	24	24.3					
21.9		2.0 ± 0.1	S 22.4	22.4	25.4			25.9	2.7	1.5
23.5			S 24	24	27			27.5		
24.5			S 25	25	28			28.5		
25.5	S 26		26	29	29.5					
27.5	S 28		28	31	31.5					
28.5	S 29		29	32	32.5					
29.5	S 30		30	33	33.5					
31.0	S 31.5		31.5	34.5	35					
31.5	S 32		32	35	35.5					
33.5	S 34		34	37	37.5					
34.5	S 35		35	38	38.5					
35.0	S 35.5		35.5	38.5	39					
35.5	S 36	36	39	39.5						
37.5	S 38	38	41	41.5						
38.5	S 39	39	42	42.5						
39.5	S 40	40	43	43.5						

- Notes
- 1) The tolerance of bore diameter d_1 shows the specified values in JIS B 2401 for class 1-A products. For class 4-D products, the tolerance is 2 times these values.
 - 2) For a static sealing application on a flat surface, design the groove according to dimension d_8 for use under external pressure, or according to dimension d_7 for use under internal pressure. An O-ring for use under external pressure can thus have its bore surface in close contact with the inner wall of the groove during use. Likewise an O-ring for use under internal pressure can thus have its circumferential surface in close contact with the outer wall of the groove.

■ Fitting groove design (unit : mm)

For static sealing on cylindrical surface

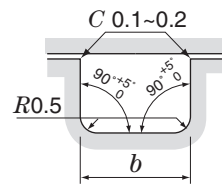
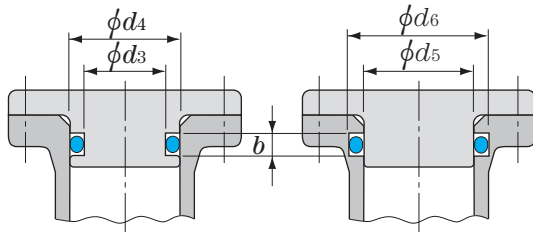

A single component

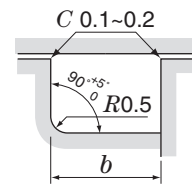

Matching two components

S 42~150

unit : mm

O-ring dimensions		O-ring No.	Groove dimensions				
Bore dia. $d_1^{1)}$	Cross section dia. d_2		$d_3, d_5, d_8^{2)}$ 0 -0.05	$d_4, d_6^{3)}$ +0.05 0	$d_7^{2)}$	$b^{4)}$ +0.25 0	$h^{5)}$ 0 -0.1
41.5	± 0.25	S 42	42	45	45.5	2.7	1.5
43.5		S 44	44	47	47.5		
44.5		S 45	45	48	48.5		
45.5		S 46	46	49	49.5		
47.5		S 48	48	51	51		
49.5		S 50	50	53	53		
52.5		S 53	53	56	56		
54.5		S 55	55	58	58		
55.5		S 56	56	59	59		
59.5		S 60	60	63	63		
62.5	2.0 ± 0.1	S 63	63	66	66	2.7	1.5
64.5		S 65	65	68	68		
66.5		S 67	67	70	70		
69.5		S 70	70	73	73		
70.5		S 71	71	74	74		
74.5		S 75	75	78	78		
79.5		S 80	80	83	83		
84.5		S 85	85	88	88		
89.5		S 90	90	93	93		
94.5		S 95	95	98	98		
99.5	± 0.4	S 100	100	103	103	2.7	1.5
104.5		S 105	105	108	108		
109.5		S 110	110	113	113		
111.5		S 112	112	115	115		
114.5		S 115	115	118	118		
119.5		S 120	120	123	123		
124.5		S 125	125	128	128		
129.5		S 130	130	133	133		
131.5		S 132	132	135	135		
134.5		S 135	135	138	138		
139.5	± 0.6	S 140	140	143	143	2.7	1.5
144.5		S 145	145	148	148		
149.5		S 150	150	153	153		

■ O-ring shape and dimensions (unit : mm)

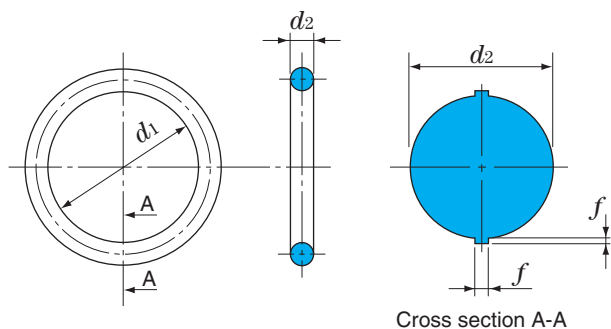

d_1 1.8~20

unit : mm

Cross section dia. d_2		1.80 ± 0.08	2.65 ± 0.09	3.55 ± 0.10	5.30 ± 0.13	7.00 ± 0.15
Dike width and height f		Up to 0.1	Up to 0.12	Up to 0.14	Up to 0.16	Up to 0.18
Bore dia. d_1	Tolerance	O-ring No.				
1.80	± 0.13	A0018G				
2.00		A0020G				
2.24		A0022G				
2.50		A0025G				
2.80	± 0.14	A0028G				
3.15		A0031G				
3.55		A0035G				
3.75		A0037G				
4.00		A0040G				
4.50		A0045G				
4.87	± 0.15	A0048G				
5.00		A0050G				
5.15		A0051G				
5.30		A0053G				
5.60		A0056G				
6.00	± 0.16	A0060G				
6.30		A0063G				
6.70		A0067G				
6.90		A0069G				
7.10		A0071G				
7.50		A0075G				
8.00	± 0.17	A0080G				
8.50		A0085G				
8.75		A0087G				
9.00		A0090G				
9.50		A0095G				
10.0	± 0.18	A0100G				
10.6		A0106G				
11.2		A0112G				
11.8	± 0.19	A0118G				
12.5		A0125G				
13.2		A0132G				
14.0		A0140G		B0140G		
15.0		A0150G		B0150G		
16.0	± 0.20	A0160G		B0160G		
17.0		A0170G		B0170G		
18.0	± 0.21			B0180G	C0180G	
19.0				B0190G	C0190G	
20.0				B0200G	C0200G	

■ Fitting groove dimensions (unit : mm)

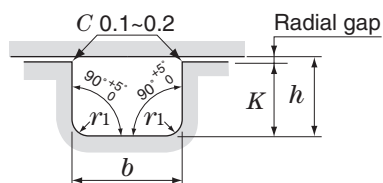

Cross section dia. d_2	Corner radius r_1
1.80 2.65	0.3 ± 0.1
3.55 5.30	0.6 ± 0.2
7.00	1.0 ± 0.2

1) Groove depth K

Determine dimension h to obtain O-ring compression rate between 8 % and 30 %.

$$\text{Compression rate} = \frac{d_2 - h}{d_2} \times 100 (\%) = 8 \% \sim 30 \%$$

Determine the radial gap by the consideration that the double radial gap (gap in diameter) should be less than the value shown in Fig. 2.5.2.

Therefore: $K = h - \text{gap in radial}$

d_2 : O-ring cross section diameter

2) Groove width b

Determine groove width by the consideration that O-ring should not occupy more than 90 % of the groove space.

$$\text{Occupancy percentage} = \frac{\pi \times (d_2/2)^2}{b \times h} \times 100 (\%) < 90 \%$$

d_1 21.2~75

unit : mm

Cross section dia. d_2		1.80 ± 0.08	2.65 ± 0.09	3.55 ± 0.10	5.30 ± 0.13	7.00 ± 0.15
Dike width and height f		Up to 0.1	Up to 0.12	Up to 0.14	Up to 0.16	Up to 0.18
Bore dia. d_1	Tolerance	O-ring No.				
21.2	± 0.23		B0212G	C0212G		
22.4			B0224G	C0224G		
23.6	± 0.24		B0236G	C0236G		
25.0	± 0.25		B0250G	C0250G		
25.8			B0258G	C0258G		
26.5	± 0.26		B0265G	C0265G		
28.0	± 0.28		B0280G	C0280G		
30.0	± 0.29		B0300G	C0300G		
31.5	± 0.31		B0315G	C0315G		
32.5	± 0.32		B0325G	C0325G		
33.5	± 0.32		B0335G	C0335G		
34.5	± 0.33		B0345G	C0345G		
35.5	± 0.34		B0355G	C0355G		
36.5	± 0.35		B0365G	C0365G		
37.5	± 0.36		B0375G	C0375G		
38.7	± 0.37		B0387G	C0387G		
40.0	± 0.38			C0400G	D0400G	
41.2	± 0.39			C0412G	D0412G	
42.5	± 0.40			C0425G	D0425G	
43.7	± 0.41			C0437G	D0437G	
45.0	± 0.42			C0450G	D0450G	
46.2	± 0.43			C0462G	D0462G	
47.5	± 0.44			C0475G	D0475G	
48.7	± 0.45			C0487G	D0487G	
50.0	± 0.46			C0500G	D0500G	
51.5	± 0.47			C0515G	D0515G	
53.0	± 0.48			C0530G	D0530G	
54.5	± 0.50			C0545G	D0545G	
56.0	± 0.51			C0560G	D0560G	
58.0	± 0.52			C0580G	D0580G	
60.0	± 0.54			C0600G	D0600G	
61.5	± 0.55			C0615G	D0615G	
63.0	± 0.56			C0630G	D0630G	
65.0	± 0.58			C0650G	D0650G	
67.0	± 0.59			C0670G	D0670G	
69.0	± 0.61			C0690G	D0690G	
71.0	± 0.63			C0710G	D0710G	
73.0	± 0.64			C0730G	D0730G	
75.0	± 0.66			C0750G	D0750G	

Material : JIS class 1-A

■ O-ring shape and dimensions (unit : mm)

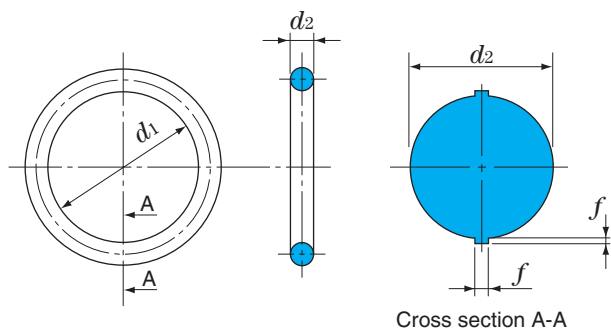

d_1 77.5~230

unit : mm

Cross section dia. d_2		1.80 ± 0.08	2.65 ± 0.09	3.55 ± 0.10	5.30 ± 0.13	7.00 ± 0.15
Dike width and height f		Up to 0.1	Up to 0.12	Up to 0.14	Up to 0.16	Up to 0.18
Bore dia. d_1	Tolerance	O-ring No.				
77.5	± 0.67			C0775G	D0775G	
80.0	± 0.69			C0800G	D0800G	
82.5	± 0.71			C0825G	D0825G	
85.0	± 0.73			C0850G	D0850G	
87.5	± 0.75			C0875G	D0875G	
90.0	± 0.77			C0900G	D0900G	
92.5	± 0.79			C0925G	D0925G	
95.0	± 0.81			C0950G	D0950G	
97.5	± 0.83			C0975G	D0975G	
100	± 0.84			C1000G	D1000G	
103	± 0.87			C1030G	D1030G	
106	± 0.89			C1060G	D1060G	
109	± 0.91			C1090G	D1090G	E1090G
112	± 0.93			C1120G	D1120G	E1120G
115	± 0.95			C1150G	D1150G	E1150G
118	± 0.97			C1180G	D1180G	E1180G
122	± 1.00			C1220G	D1220G	E1220G
125	± 1.03			C1250G	D1250G	E1250G
128	± 1.05			C1280G	D1280G	E1280G
132	± 1.08			C1320G	D1320G	E1320G
136	± 1.10			C1360G	D1360G	E1360G
140	± 1.13			C1400G	D1400G	E1400G
145	± 1.17			C1450G	D1450G	E1450G
150	± 1.20			C1500G	D1500G	E1500G
155	± 1.24			C1550G	D1550G	E1550G
160	± 1.27			C1600G	D1600G	E1600G
165	± 1.31			C1650G	D1650G	E1650G
170	± 1.34			C1700G	D1700G	E1700G
175	± 1.38			C1750G	D1750G	E1750G
180	± 1.41			C1800G	D1800G	E1800G
185	± 1.44			C1850G	D1850G	E1850G
190	± 1.48			C1900G	D1900G	E1900G
195	± 1.51			C1950G	D1950G	E1950G
200	± 1.55			C2000G	D2000G	E2000G
206	± 1.59				D2060G	E2060G
212	± 1.63				D2120G	E2120G
218	± 1.67				D2180G	E2180G
224	± 1.71				D2240G	E2240G
230	± 1.75				D2300G	E2300G

■ Fitting groove dimensions (unit : mm)

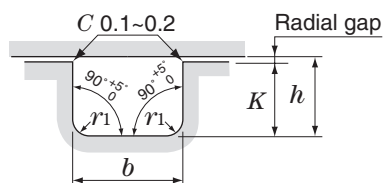

Cross section dia. d_2	Corner radius r_1
1.80 2.65	0.3 ± 0.1
3.55 5.30	0.6 ± 0.2
7.00	1.0 ± 0.2

1) Groove depth K

Determine dimension h to obtain O-ring compression rate between 8 % and 30 %.

$$\text{Compression rate} = \frac{d_2 - h}{d_2} \times 100 (\%) = 8 \% \sim 30 \%$$

Determine the radial gap by the consideration that the double radial gap (gap in diameter) should be less than the value shown in Fig. 2.5.2.

Therefore: $K = h - \text{gap in radial}$

d_2 : O-ring cross section diameter

2) Groove width b

Determine groove width by the consideration that O-ring should not occupy more than 90 % of the groove space.

$$\text{Occupancy percentage} = \frac{\pi \times (d_2/2)^2}{b \times h} \times 100 (\%) < 90 \%$$

d_1 236~670

unit : mm

Cross section dia. d_2		1.80 ± 0.08	2.65 ± 0.09	3.55 ± 0.10	5.30 ± 0.13	7.00 ± 0.15
Dike width and height f		Up to 0.1	Up to 0.12	Up to 0.14	Up to 0.16	Up to 0.18
Bore dia. d_1	Tolerance	O-ring No.				
236	± 1.79				D2360G	E2360G
243	± 1.83				D2430G	E2430G
250	± 1.88				D2500G	E2500G
258	± 1.93				D2580G	E2580G
265	± 1.98				D2650G	E2650G
272	± 2.02				D2720G	E2720G
280	± 2.08				D2800G	E2800G
290	± 2.14				D2900G	E2900G
300	± 2.21				D3000G	E3000G
307	± 2.25				D3070G	E3070G
315	± 2.30				D3150G	E3150G
325	± 2.37				D3250G	E3250G
335	± 2.43				D3350G	E3350G
345	± 2.49				D3450G	E3450G
355	± 2.56				D3550G	E3550G
365	± 2.62				D3650G	E3650G
375	± 2.68				D3750G	E3750G
387	± 2.76				D3870G	E3870G
400	± 2.84				D4000G	E4000G
412	± 2.91					E4120G
425	± 2.99					E4250G
437	± 3.07					E4370G
450	± 3.15					E4500G
462	± 3.22					E4620G
475	± 3.30					E4750G
487	± 3.37					E4870G
500	± 3.45					E5000G
515	± 3.54					E5150G
530	± 3.63					E5300G
545	± 3.72					E5450G
560	± 3.81					E5600G
580	± 3.93					E5800G
600	± 4.05					E6000G
615	± 4.13					E6150G
630	± 4.22					E6300G
650	± 4.34					E6500G
670	± 4.46					E6700G

■ O-ring shape and dimensions (unit : mm)

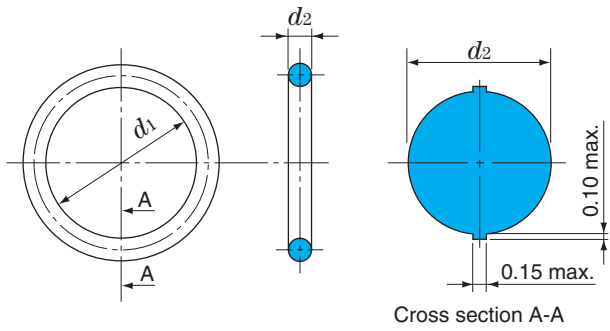

■ Fitting groove dimensions

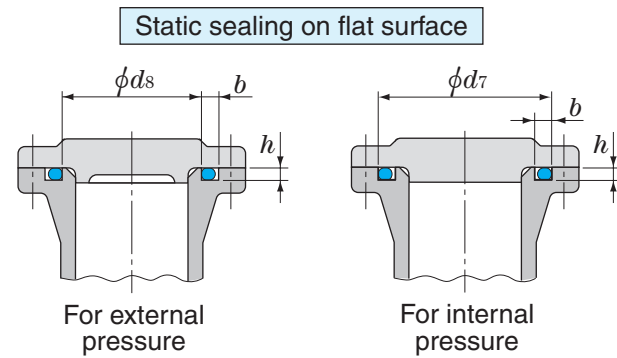

For static sealing on cylindrical surface

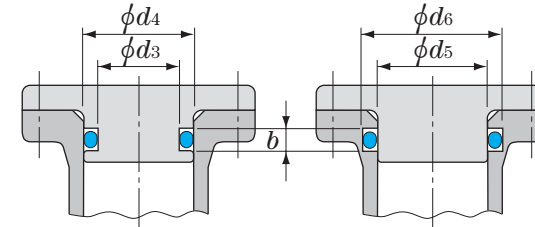

For dynamic sealing

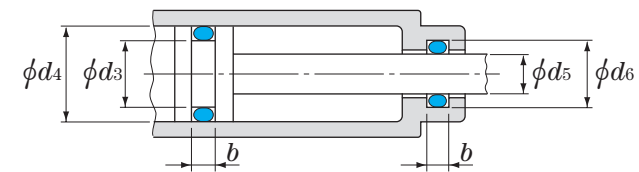

■ Fitting groove design (unit : mm)

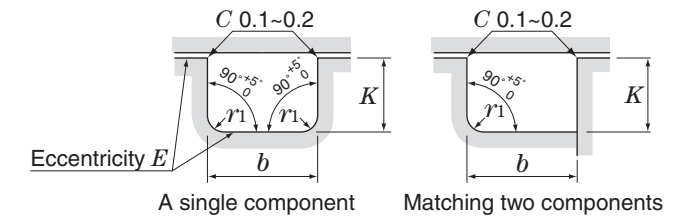

■ Backup rings

(For dynamic sealing and static sealing on cylindrical surface)

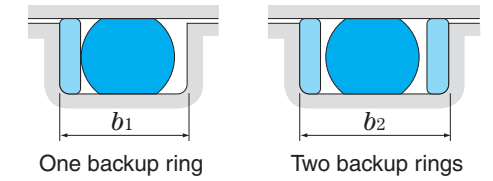

unit : mm

d_2 1.9

O-ring dimensions		O-ring No.	Groove dimensions for static sealing on flat surface				Groove dimensions for dynamic sealing and static sealing on cylindrical surface												
Bore dia. d_1	Cross section dia. d_2		d_s ¹⁾ (for external pressure)	d_7 ¹⁾ (for internal pressure)	$b + 0.25$ 0	$h \pm 0.05$	r_1 max.	O-ring No.	d_3	d_5	Tolerances of d_3 and d_5	d_4	d_6	Tolerances of d_4 and d_6	$b + 0.25$ 0 Without backup ring	$b_1 + 0.25$ 0 With one backup ring	$b_2 + 0.25$ 0 With two backup rings	E ²⁾ max.	r_1 max.
2.8	1.9 ± 0.07	JASO 1003	3	6.3	2.5	1.4	0.4	JASO 1003	3.1	3	0 -0.05	6	5.9	+0.05 0	2.5	3.9	5.4	0.05	0.4
3.8		JASO 1004	4	7.3				JASO 1004	4.1	4		7	6.9						
4.8		JASO 1005	5	8.3				JASO 1005	5.1	5		8	7.9						
5.8		JASO 1006	6	9.3				JASO 1006	6.1	6		9	8.9						
6.8		JASO 1007	7	10.3				JASO 1007	7.1	7		10	9.9						
7.8		JASO 1008	8	11.3				JASO 1008	8.1	8		11	10.9						
8.8		JASO 1009	9	12.3				JASO 1009	9.1	9		12	11.9						
9.8		JASO 1010	10	13.3				JASO 1010	10.1	10		13	12.9						
11.0		JASO 1011	11.2	14.4				JASO 1011	11.3	11.2		14.2	14.1						
12.3		JASO 1012	12.5	15.7				JASO 1012	12.6	12.5		15.5	15.4						
13.0		JASO 1013	13.2	16.4				JASO 1013	13.3	13.2		16.2	16.1						
13.8		JASO 1014	14	17.2				JASO 1014	14.1	14		17	16.9						
14.8		JASO 1015	15	18.2				JASO 1015	15.1	15		18	17.9						
15.8		JASO 1016	16	19.2				JASO 1016	16.1	16		19	18.9						
16.8		JASO 1017	17	20.2				JASO 1017	17.1	17		20	19.2						
17.8		JASO 1018	18	21.2				JASO 1018	18.1	18		21	20.9						
18.8	JASO 1019	19	22.2	JASO 1019	19.1	19	22	21.9											
19.8	JASO 1020	20	23.2	JASO 1020	20.1	20	23	22.9											
21.0	JASO 1021	21.2	24.4	JASO 1021	21.3	21.2	24.2	24.1											
22.1	JASO 1022	22.4	25.5	JASO 1022	22.5	22.4	25.4	25.3											
23.3	JASO 1023	23.6	26.7	JASO 1023	23.7	23.6	26.6	26.5											
24.7	JASO 1025	25	28.1	JASO 1025	25.1	25	28	27.9											
26.2	JASO 1026	26.5	29.6	JASO 1026	26.6	26.5	29.5	29.4											
27.7	JASO 1028	28	31.1	JASO 1028	28.1	28	31	30.9											
29.7	JASO 1030	30	33.1	JASO 1030	30.1	30	33	32.9											
31.2	JASO 1031	31.5	34.6	JASO 1031	31.6	31.5	34.5	34.4											
33.2	JASO 1033	33.5	36.6	JASO 1033	33.6	33.5	36.5	36.4											
35.2	JASO 1035	35.5	38.6	JASO 1035	35.6	35.5	38.5	38.4											

Notes 1) For a static sealing application on a flat surface, design the groove according to dimension d_s for use under external pressure, or according to dimension d_7 for use under internal pressure. An O-ring for use under external pressure can thus have its bore surface in close contact with the inner wall of the groove during use. Likewise an O-ring for use under internal pressure can thus have its circumferential surface in close contact with the outer wall of the groove.
2) Eccentricity E means the difference between the maximum value and minimum value of dimension K . The eccentricity can also be defined as double the coaxiality measurement.

■ O-ring shape and dimensions (unit : mm)

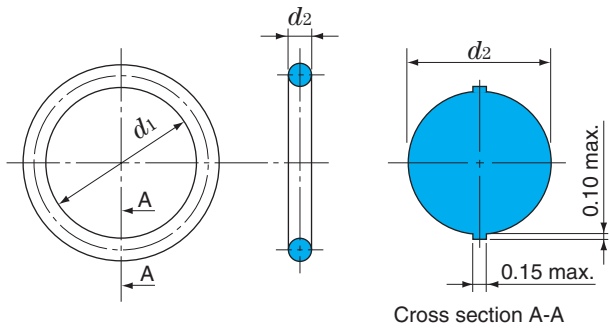

■ Fitting groove dimensions

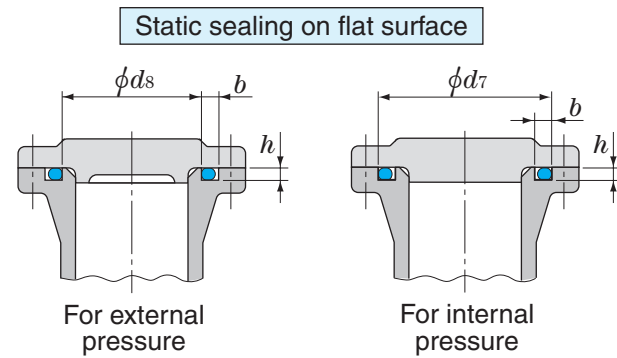

For static sealing on cylindrical surface

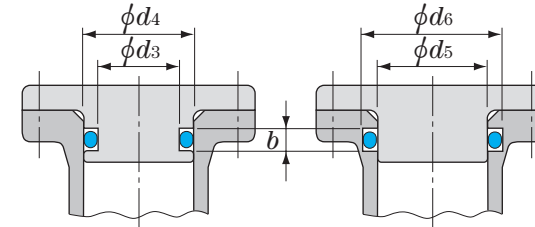

For dynamic sealing

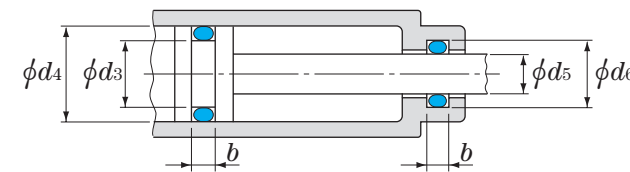

■ Fitting groove design (unit : mm)

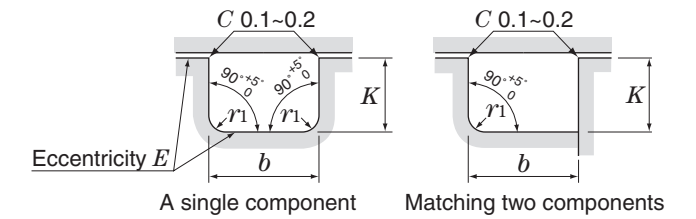

■ Backup rings
(For dynamic sealing and static sealing on cylindrical surface)

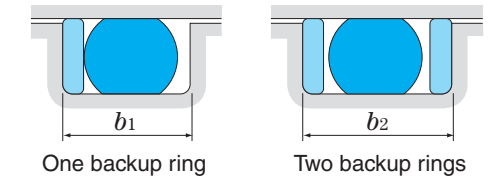

unit : mm

d_2 2.4

O-ring dimensions		O-ring No.	Groove dimensions for static sealing on flat surface				Groove dimensions for dynamic sealing and static sealing on cylindrical surface												
Bore dia. d_1	Cross section dia. d_2		d_s ¹⁾ (for external pressure)	d_7 ¹⁾ (for internal pressure)	$b + 0.25$ 0	$h \pm 0.05$	r_1 max.	O-ring No.	d_3	d_5	Tolerances of d_3 and d_5	d_4	d_6	Tolerances of d_4 and d_6	$b + 0.25$ 0 Without backup ring	$b_1 + 0.25$ 0 With one backup ring	$b_2 + 0.25$ 0 With two backup rings	E ²⁾ max.	r_1 max.
9.8	Classes 1 - A and 2 ± 0.12	JASO 2010	10	14.1	3.2	1.8	0.4	JASO 2010	10.2	10	0 -0.06	14	13.8	+ 0.06 0	3.2	4.4	6.0	0.05	0.4
11.0		JASO 2011	11.2	15.3				JASO 2011	11.4	11.2		15.2	15						
12.3		JASO 2012	12.5	16.6				JASO 2012	12.7	12.5		16.5	16.3						
13.0	Classes 3 and 4 - D ± 0.24	JASO 2013	13.2	17.3	3.2	1.8	0.4	JASO 2013	13.4	13.2	0 -0.06	17.2	17	+ 0.06 0	3.2	4.4	6.0	0.05	0.4
13.8		JASO 2014	14	18.1				JASO 2014	14.2	14		18	17.8						
14.8		JASO 2015	15	19.1				JASO 2015	15.2	15		19	18.8						
15.8	Classes 4 - C, 4 - E and 5 ± 0.36	JASO 2016	16	20.1	3.2	1.8	0.4	JASO 2016	16.2	16	0 -0.06	20	19.8	+ 0.06 0	3.2	4.4	6.0	0.05	0.4
16.8		JASO 2017	17	21.1				JASO 2017	17.2	17		21	20.8						
17.8		JASO 2018	18	22.1				JASO 2018	18.2	18		22	21.8						
18.8	Classes 1 - A and 2 ± 0.15	JASO 2019	19	23.1	3.2	1.8	0.4	JASO 2019	19.2	19	0 -0.06	23	22.8	+ 0.06 0	3.2	4.4	6.0	0.05	0.4
19.8		JASO 2020	20	24.1				JASO 2020	20.2	20		24	23.8						
20.8		JASO 2021	21	25.1				JASO 2021	21.2	21		25	24.8						
22.1	Classes 1 - A and 2 ± 0.15	JASO 2022	22.4	26.4	3.2	1.8	0.4	JASO 2022	22.6	22.4	0 -0.06	26.4	26.2	+ 0.06 0	3.2	4.4	6.0	0.05	0.4
23.3		JASO 2023	23.6	27.6				JASO 2023	23.8	23.6		27.6	27.4						
24.7		JASO 2025	25	29				JASO 2025	25.2	25		29	28.8						
26.2	Classes 3 and 4 - D ± 0.30	JASO 2026	26.5	30.5	3.2	1.8	0.4	JASO 2026	26.7	26.5	0 -0.06	30.5	30.3	+ 0.06 0	3.2	4.4	6.0	0.05	0.4
27.7		JASO 2028	28	32				JASO 2028	28.2	28		32	31.8						
29.7		JASO 2030	30	34				JASO 2030	30.2	30		34	33.8						
31.2	Classes 4 - C, 4 - E and 5 ± 0.45	JASO 2031	31.5	35.5	3.2	1.8	0.4	JASO 2031	31.7	31.5	0 -0.06	35.5	35.3	+ 0.06 0	3.2	4.4	6.0	0.05	0.4
33.2		JASO 2033	33.5	37.5				JASO 2033	33.7	33.5		37.5	37.3						
35.2		JASO 2035	35.5	39.5				JASO 2035	35.7	35.5		39.5	39.3						
37.2	Classes 1 - A and 2 ± 0.25	JASO 2037	37.5	41.5	3.2	1.8	0.4	JASO 2037	37.7	37.5	0 -0.06	41.5	41.3	+ 0.06 0	3.2	4.4	6.0	0.05	0.4
39.7		JASO 2040	40	44				JASO 2040	40.2	40		44	43.8						
42.2		JASO 2042	42.5	46.5				JASO 2042	42.7	42.5		46.5	46.3						
44.7	Classes 3 and 4 - D ± 0.50	JASO 2045	45	49	3.2	1.8	0.4	JASO 2045	45.2	45	0 -0.06	49	48.8	+ 0.06 0	3.2	4.4	6.0	0.05	0.4
47.2		JASO 2047	47.5	51.5				JASO 2047	47.7	47.5		51.5	51.3						
49.7		JASO 2050	50	54				JASO 2050	50.2	50		54	53.8						
52.6	Classes 4 - C, 4 - E and 5 ± 0.75	JASO 2053	53	57	3.2	1.8	0.4	JASO 2053	53.2	53	0 -0.06	57	56.8	+ 0.06 0	3.2	4.4	6.0	0.05	0.4
55.6		JASO 2056	56	60				JASO 2056	56.2	56		60	59.8						
59.6		JASO 2060	60	64				JASO 2060	60.2	60		64	63.8						
62.6	Classes 1 - A and 2 ± 0.40	JASO 2063	63	67	3.2	1.8	0.4	JASO 2063	63.2	63	0 -0.06	67	66.8	+ 0.06 0	3.2	4.4	6.0	0.05	0.4
66.6		JASO 2067	67	71				JASO 2067	67.2	67		71	70.8						
70.6		JASO 2071	71	75				JASO 2071	71.2	71		75	74.8						

Notes 1) For a static sealing application on a flat surface, design the groove according to dimension d_s for use under external pressure, or according to dimension d_7 for use under internal pressure. An O-ring for use under external pressure can thus have its bore surface in close contact with the inner wall of the groove during use. Likewise an O-ring for use under internal pressure can thus have its circumferential surface in close contact with the outer wall of the groove.
2) Eccentricity E means the difference between the maximum value and minimum value of dimension K . The eccentricity can also be defined as double the coaxiality measurement.

■ O-ring shape and dimensions (unit : mm)

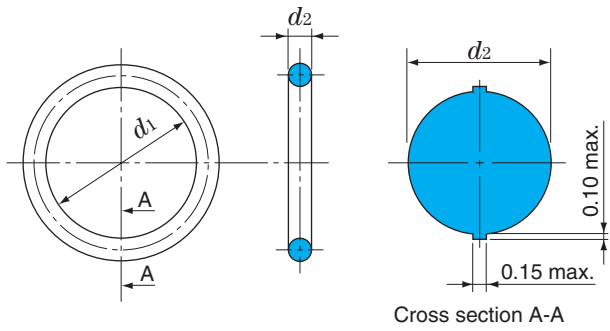

■ Fitting groove dimensions

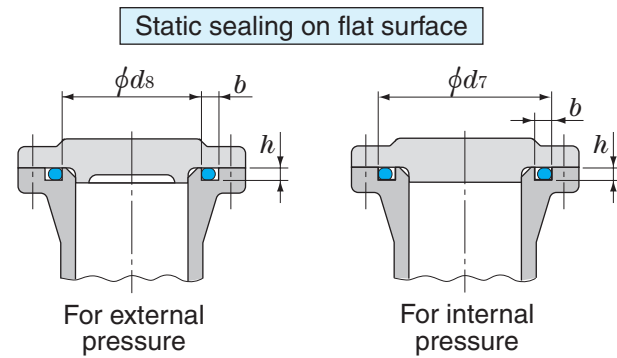

For static sealing on cylindrical surface

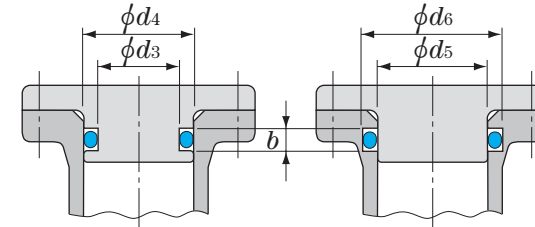

For dynamic sealing

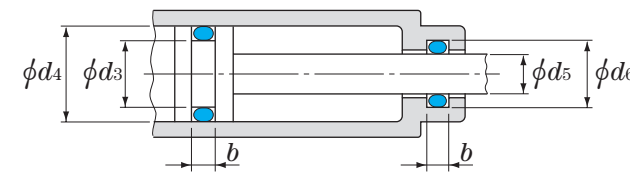

■ Fitting groove design (unit : mm)

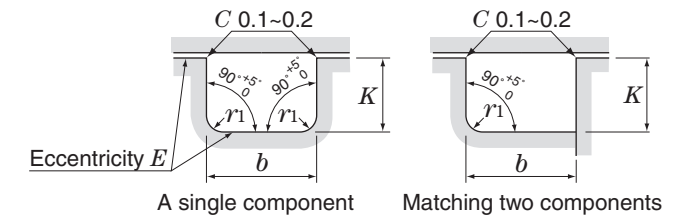

■ Backup rings
(For dynamic sealing and static sealing on cylindrical surface)

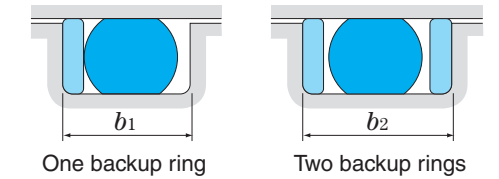

unit : mm

d_2 3.5

O-ring dimensions		O-ring No.	Groove dimensions for static sealing on flat surface				Groove dimensions for dynamic sealing and static sealing on cylindrical surface												
Bore dia. d_1	Cross section dia. d_2		d_s ¹⁾ (for external pressure)	d_7 ¹⁾ (for internal pressure)	$b + 0.25$ 0	$h \pm 0.05$	r_1 max.	O-ring No.	d_3	d_5	Tolerances of d_3 and d_5	d_4	d_6	Tolerances of d_4 and d_6	b ^{+0.25} ₀ Without backup ring	b_1 ^{+0.25} ₀ With one backup ring	b_2 ^{+0.25} ₀ With two backup rings	E ²⁾ max.	r_1 max.
22.1	3.5 ± 0.10	JASO 3022	22.4	28.4	4.7	2.7	0.7	JASO 3022	22.7	22.4	0 -0.08	28.4	28.1	+0.08 0	4.7	6.0	7.8	0.08	0.7
23.7		JASO 3024	24	30				JASO 3024	24.3	24		30	29.7						
24.7		JASO 3025	25	31				JASO 3025	25.3	25		31	30.7						
25.7		JASO 3026	26	32				JASO 3026	26.3	26		32	31.7						
27.7		JASO 3028	28	34				JASO 3028	28.3	28		34	33.7						
29.7		JASO 3030	30	36				JASO 3030	30.3	30		36	35.7						
31.2		JASO 3031	31.5	37.5				JASO 3031	31.8	31.5		37.5	37.2						
33.7		JASO 3034	34	40				JASO 3034	34.3	34		40	39.7						
35.2		JASO 3035	35.5	41.5				JASO 3035	35.8	35.5		41.5	41.2						
37.7		JASO 3038	38	44				JASO 3038	38.3	38		44	43.7						
38.7		JASO 3039	39	45				JASO 3039	39.3	39		45	44.7						
39.7		JASO 3040	40	46				JASO 3040	40.3	40		46	45.7						
41.7		JASO 3042	42	48				JASO 3042	42.3	42		48	47.7						
43.7		JASO 3044	44	50				JASO 3044	44.3	44		50	49.7						
44.7		JASO 3045	45	51				JASO 3045	45.3	45		51	50.7						
47.7	JASO 3048	48	54	JASO 3048	48.3	48	54	53.7											
49.7	JASO 3050	50	56	JASO 3050	50.3	50	56	55.7											
52.6	JASO 3053	53	59	JASO 3053	53.3	53	59	58.7											
55.6	JASO 3056	56	62	JASO 3056	56.3	56	62	61.7											
59.6	JASO 3060	60	66	JASO 3060	60.3	60	66	65.7											
62.6	JASO 3063	63	69	JASO 3063	63.3	63	69	68.7											
66.6	JASO 3067	67	73	JASO 3067	67.3	67	73	72.7											
70.6	JASO 3071	71	77	JASO 3071	71.3	71	77	76.7											
74.6	JASO 3075	75	81	JASO 3075	75.3	75	81	80.7											
79.6	JASO 3080	80	86	JASO 3080	80.3	80	86	85.7											
84.6	JASO 3085	85	91	JASO 3085	85.3	85	91	90.7											
89.6	JASO 3090	90	96	JASO 3090	90.3	90	96	95.7											
94.6	JASO 3095	95	101	JASO 3095	95.3	95	101	100.7											
99.6	JASO 3100	100	106	JASO 3100	100.3	100	106	105.7											
105.6	JASO 3106	106	112	JASO 3106	106.3	106	112	111.7											
111.6	JASO 3112	112	118	JASO 3112	112.3	112	118	117.7											
117.6	JASO 3118	118	124	JASO 3118	118.3	118	124	123.7											
124.6	JASO 3125	125	131	JASO 3125	125.3	125	131	130.7											
131.6	JASO 3132	132	138	JASO 3132	132.3	132	138	137.7											
139.6	JASO 3140	140	146	JASO 3140	140.3	140	146	145.7											
149.6	JASO 3150	150	156	JASO 3150	150.3	150	156	155.7											

Notes 1) For a static sealing application on a flat surface, design the groove according to dimension d_s for use under external pressure, or according to dimension d_7 for use under internal pressure. An O-ring for use under external pressure can thus have its bore surface in close contact with the inner wall of the groove during use. Likewise an O-ring for use under internal pressure can thus have its circumferential surface in close contact with the outer wall of the groove.
2) Eccentricity E means the difference between the maximum value and minimum value of dimension K . The eccentricity can also be defined as double the coaxiality measurement.

AS d_2 1.02~(2.62)

AS 568 for Aircraft Hydraulic Applications (Dynamic Sealing and Static Sealing)

Material : JIS classes 1-A, 1-B and 4-D

■ O-ring shape and dimensions (unit : mm)

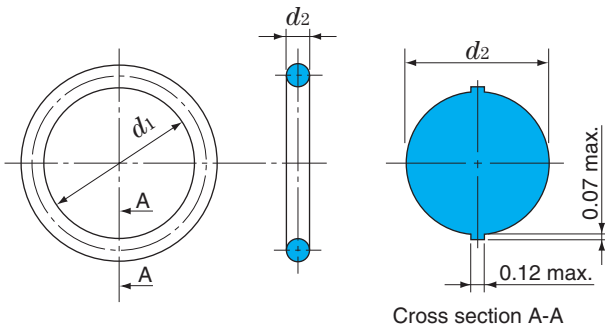

■ Fitting groove dimensions (unit : mm)

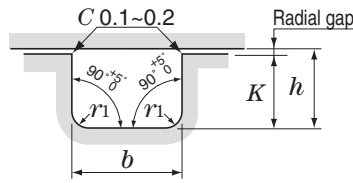

Cross section dia. d_2		Corner radius r_1 max
Over	Up to	
—	3.00	0.4
3.00	6.98	0.8

1) Groove depth K

Determine dimension h to obtain O-ring compression rate between 8 % and 30 %.

$$\text{Compression rate} = \frac{d_2 - h}{d_2} \times 100 (\%) = 8 \% \sim 30 \%$$

Determine the radial gap by the consideration that the double radial gap (gap in diameter) should be less than the value shown in Fig. 2.5.2.

Therefore: $K = h - \text{gap in radial}$

d_2 : O-ring cross section diameter

2) Groove width b

Determine groove width by the consideration that O-ring should not occupy more than 90 % of the groove space.

$$\text{Occupancy percentage} = \frac{\pi \times (d_2/2)^2}{b \times h} \times 100 (\%) < 90 \%$$

d_2 1.02~(1.78)

unit : mm

O-ring dimensions			O-ring No.	Reference No.	
Cross section dia. d_2	Bore dia. d_1 ¹⁾			AN 6227	AN 6230
1.02 ± 0.07	0.74		AS 001		
1.27 ± 0.07	1.07	± 0.10	AS 002		
1.42 ± 0.07	4.70	± 0.12	AS 901		
1.52 ± 0.07	1.42	± 0.10	AS 003		
1.63 ± 0.07	6.07	± 0.12	AS 902		
	7.64		AS 903		
1.78 ± 0.07	1.78	± 0.12	AS 004		
	2.57		AS 005		
	2.90		AS 006	1	
	3.68		AS 007	2	
	4.47		AS 008	3	
	5.28		AS 009	4	
	6.07		AS 010	5	
	7.65		AS 011	6	
	9.25		AS 012	7	
	10.82		AS 013		
	12.42		AS 014		
	14.00		AS 015		
	15.60		AS 016		
	17.17		AS 017		
	18.77		AS 018		
20.35	AS 019				
21.95	AS 020				
23.52	AS 021				
25.12	AS 022				
26.70	AS 023				
28.30	AS 024				
29.87	AS 025				
31.47	AS 026				
33.05	AS 027				
34.65	AS 028				
37.82	AS 029				
41.00	AS 030				
44.17	AS 031				
47.35	AS 032				
50.52	AS 033				
53.70	AS 034				
56.87	AS 035				
60.05	AS 036				
63.22	AS 037				

Note 1) The tolerance of bore diameter d_1 shows the specified values in JIS B 2401 for class 1-A and 1-B products. For class 4-D products, consult JTEKT.

d_2 (1.78)~(2.62)

unit : mm

O-ring dimensions		O-ring No.	Reference No.		
Cross section dia. d_2	Bore dia. $d_1^{1)}$		AN 6227	AN 6230	
1.78 ± 0.07	66.40	± 0.25			
	69.57	± 0.38			
	72.75				
	75.92				
	82.27				
	88.62				
	94.97				
	101.32				
	107.67				
	114.02				
120.37	± 0.58				
126.72					
133.07	± 0.12				
1.83 ± 0.07		8.92			
		10.52			
1.98 ± 0.07		11.89			
2.08 ± 0.07		13.46			
2.21 ± 0.07		16.36			
2.46 ± 0.07		17.93			
		19.18			
2.62 ± 0.07		1.24	± 0.12		
		2.06			
	2.84				
	3.63				
	4.42				
	5.23				
	6.02				
	7.59				
	9.19				
	10.77				
	12.37				
	13.94				
	15.54				
	17.12				
	18.72				
	20.29	± 0.15			
	21.89				
	23.47				
	25.07				
	26.64				
28.24					
29.82					
31.42					
32.99	± 0.25				
34.59					
36.17					
37.77					
39.34					
40.94					
42.52					
44.12					
45.69					
47.29					
48.90					
50.47					
52.07					
53.64					

Material : JIS classes 1-A, 1-B and 4-D

■ O-ring shape and dimensions (unit : mm)

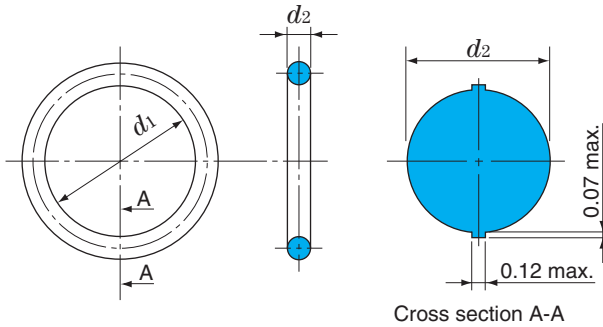

■ Fitting groove dimensions (unit : mm)

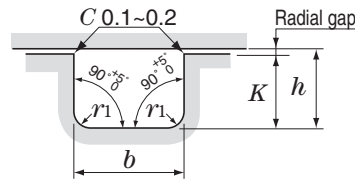

Cross section dia. d_2		Corner radius r_1 max
Over	Up to	
—	3.00	0.4
3.00	6.98	0.8

1) Groove depth K

Determine dimension h to obtain O-ring compression rate between 8 % and 30 %.

$$\text{Compression rate} = \frac{d_2 - h}{d_2} \times 100 (\%) = 8 \% \sim 30 \%$$

Determine the radial gap by the consideration that the double radial gap (gap in diameter) should be less than the value shown in Fig. 2.5.2.

Therefore: $K = h - \text{gap in radial}$

d_2 : O-ring cross section diameter

2) Groove width b

Determine groove width by the consideration that O-ring should not occupy more than 90 % of the groove space.

$$\text{Occupancy percentage} = \frac{\pi \times (d_2/2)^2}{b \times h} \times 100 (\%) < 90 \%$$

d_2 (2.62)

unit : mm

O-ring dimensions		O-ring No.	Reference No.		
Cross section dia. d_2	Bore dia. $d_1^{1)}$		AN 6227	AN 6230	
2.62 ± 0.07	55.24	AS 139			
	56.82	AS 140			
	58.42	AS 141			
	59.99	± 0.25			AS 142
	61.60				AS 143
	63.17				AS 144
	64.77	± 0.38			AS 145
	66.34				AS 146
	67.94				AS 147
	69.52				AS 148
	71.12				AS 149
	72.69				AS 150
	75.87				AS 151
	82.22				AS 152
	88.57				AS 153
	94.92				AS 154
	101.27	AS 155			
	107.62	± 0.58			AS 156
	113.97				AS 157
	120.32				AS 158
	126.67				AS 159
	133.02				AS 160
	139.37				AS 161
	145.72				AS 162
	152.07				AS 163
	158.42				AS 164
	164.77				AS 165
	171.12	± 0.76			AS 166
	177.47				AS 167
	183.82				AS 168
	190.17				AS 169
	196.52				AS 170
	202.87				AS 171
	209.22				AS 172
	215.57				AS 173
	221.92				AS 174
228.27	AS 175				
234.62	AS 176				
240.97	AS 177				
247.32	AS 178				

Note 1) The tolerance of bore diameter d_1 shows the specified values in JIS B 2401 for class 1-A and 1-B products. For class 4-D products, consult JTEKT.

d_2 2.95~(3.53)

unit : mm

O-ring dimensions		O-ring No.	Reference No.	
Cross section dia. d_2	Bore dia. $d_1^{1)}$		AN 6227	AN 6230
2.95 ± 0.10	21.92	± 0.12		
	23.47	± 0.15		
	25.04			
	26.59			
	29.74			
	34.42			
3.00 ± 0.10	37.46			
	43.69			
	53.09			
	59.36			
3.53 ± 0.10	4.34	± 0.12		
	5.94			
	7.52			
	9.12			
	10.69			
	12.29			
	13.87			
	15.47			
	17.04			
	18.64	± 0.15		
	20.22			
	21.82			
	23.39			
	24.99			
	26.57			
	28.17			
	29.74			
	31.34			
	32.92	± 0.25		
	34.52			
	36.09			
	37.69			
	40.87			
	44.04			
	47.22			
	50.39			
	53.57			
	56.74			
	59.92	± 0.38		
	63.09			
66.27				
69.44				
72.62				
75.79				
78.97				
82.14				
85.32				
88.49	± 0.38			
91.67				
94.84				
98.02				
101.19				
104.37				
107.54				
110.72				
113.89				
117.07				

AS d_2 (3.53)~(5.33)

AS 568 for Aircraft Hydraulic Applications (Dynamic Sealing and Static Sealing)

Material : JIS classes 1-A, 1-B and 4-D

■ O-ring shape and dimensions (unit : mm)

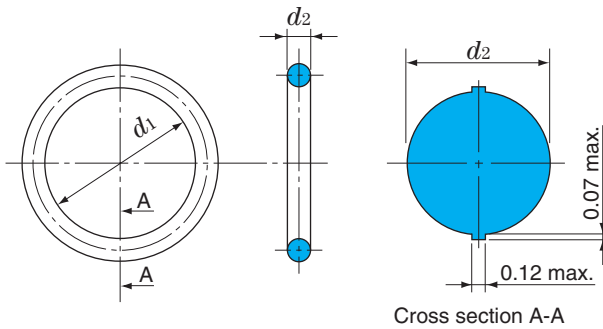

■ Fitting groove dimensions (unit : mm)

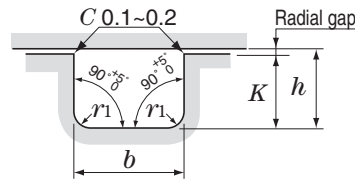

Cross section dia. d_2		Corner radius r_1 max
Over	Up to	
—	3.00	0.4
3.00	6.98	0.8

1) Groove depth K

Determine dimension h to obtain O-ring compression rate between 8 % and 30 %.

$$\text{Compression rate} = \frac{d_2 - h}{d_2} \times 100 (\%) = 8 \% \sim 30 \%$$

Determine the radial gap by the consideration that the double radial gap (gap in diameter) should be less than the value shown in Fig. 2.5.2.

Therefore: $K = h - \text{gap in radial}$

d_2 : O-ring cross section diameter

2) Groove width b

Determine groove width by the consideration that O-ring should not occupy more than 90 % of the groove space.

$$\text{Occupancy percentage} = \frac{\pi \times (d_2/2)^2}{b \times h} \times 100 (\%) < 90 \%$$

d_2 (3.53)~(5.33)

unit : mm

O-ring dimensions			O-ring No.	Reference No.	
Cross section dia. d_2	Bore dia. $d_1^{1)}$			AN 6227	AN 6230
3.53 ± 0.10	120.24	± 0.38	AS 248		26
	123.42		AS 249		27
	126.59		AS 250		28
	129.77		AS 251		29
	132.94		AS 252		30
	136.12		AS 253		31
	139.29	± 0.58	AS 254		32
	142.47		AS 255		33
	145.64		AS 256		34
	148.82		AS 257		35
	151.99		AS 258		36
	158.34		AS 259		37
	164.69		AS 260		38
	171.04		AS 261		39
	177.39		AS 262		40
	183.74		AS 263		41
	190.09		AS 264		42
	196.44	AS 265	43		
	202.79	± 0.76	AS 266		44
	209.14		AS 267		45
	215.49		AS 268		46
	221.84		AS 269		47
	228.19		AS 270		48
	234.54		AS 271		49
	240.89		AS 272		50
	247.24		AS 273		51
	253.59		AS 274		52
266.29	AS 275				
278.99	AS 276				
291.69	AS 277				
304.39	AS 278				
329.79	AS 279				
355.19	AS 280				
380.59	AS 281				
405.26	± 1.14	AS 282			
430.66		AS 283			
456.06		AS 284			
5.33 ± 0.12	10.46	± 0.12	AS 309		
	12.06		AS 310		
	13.64		AS 311		

Note 1) The tolerance of bore diameter d_1 shows the specified values in JIS B 2401 for class 1-A and 1-B products. For class 4-D products, consult JTEKT.

d_2 (5.33)

unit : mm

O-ring dimensions		O-ring No.	Reference No.		
Cross section dia. d_2	Bore dia. $d_1^{1)}$		AN 6227	AN 6230	
5.33 ± 0.12	15.24	± 0.12	AS 312		
	16.81		AS 313		
	18.42	± 0.15	AS 314		
	19.99		AS 315		
	21.59		AS 316		
	23.16		AS 317		
	24.76		AS 318		
	26.34		AS 319		
	27.94		AS 320		
	29.51		AS 321		
	31.12		AS 322		
	32.69		AS 323		
	34.29	AS 324			
	37.46	± 0.25	AS 325		28
	40.64		AS 326		29
	43.82		AS 327		30
	46.99		AS 328		31
	50.16		AS 329		32
	53.34		AS 330		33
	56.52		AS 331		34
	59.69		AS 332		35
	62.86		AS 333		36
	66.04		AS 334		37
	69.22	± 0.38	AS 335		38
	72.39		AS 336		39
	75.56		AS 337		40
	78.74		AS 338		41
	81.92		AS 339		42
	85.09		AS 340		43
	88.26		AS 341		44
	91.44		AS 342		45
	94.62		AS 343		46
	97.79		AS 344		47
	100.96	AS 345	48		
	104.14	AS 346	49		
	107.32	AS 347	50		
110.49	AS 348	51			
113.66	AS 349	52			
116.84	± 0.58	AS 350			
120.02		AS 351			
123.19		AS 352			
126.36		AS 353			
129.54		AS 354			
132.72		AS 355			
135.89		AS 356			
139.07		AS 357			
142.24		AS 358			
145.42		AS 359			
148.59	± 0.76	AS 360			
151.77		AS 361			
158.12		AS 362			
164.47		AS 363			
170.82		AS 364			
177.17	AS 365				
183.52	± 0.76	AS 366			
189.87		AS 367			
196.22		AS 368			

AS d_2 (5.33)~6.98

AS 568 for Aircraft Hydraulic Applications (Dynamic Sealing and Static Sealing)

Material : JIS classes 1-A, 1-B and 4-D

■ O-ring shape and dimensions (unit : mm)

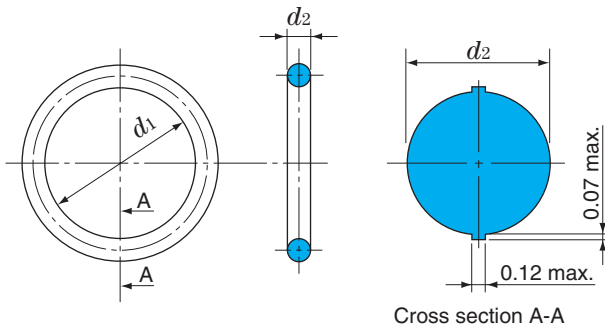

■ Fitting groove dimensions (unit : mm)

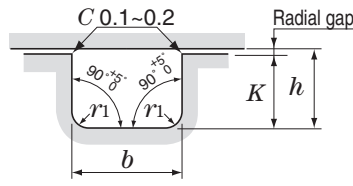

Cross section dia. d_2		Corner radius r_1 max
Over	Up to	
—	3.00	0.4
3.00	6.98	0.8

1) Groove depth K

Determine dimension h to obtain O-ring compression rate between 8 % and 30 %.

$$\text{Compression rate} = \frac{d_2 - h}{d_2} \times 100 (\%) = 8 \% \sim 30 \%$$

Determine the radial gap by the consideration that the double radial gap (gap in diameter) should be less than the value shown in Fig. 2.5.2.

Therefore: $K = h - \text{gap in radial}$

d_2 : O-ring cross section diameter

2) Groove width b

Determine groove width by the consideration that O-ring should not occupy more than 90 % of the groove space.

$$\text{Occupancy percentage} = \frac{\pi \times (d_2/2)^2}{b \times h} \times 100 (\%) < 90 \%$$

d_2 (5.33)~(6.98)

unit : mm

O-ring dimensions			O-ring No.	Reference No.	
Cross section dia. d_2	Bore dia. $d_1^{1)}$			AN 6227	AN 6230
5.33 ± 0.12	202.57	± 0.76	AS 369		
	208.92		AS 370		
	215.26		AS 371		
	221.62		AS 372		
	227.96		AS 373		
	234.32		AS 374		
	240.67		AS 375		
	247.02		AS 376		
	253.37		AS 377		
	266.07		AS 378		
	278.77	AS 379			
	291.47	AS 380			
	304.17	AS 381			
	329.57	AS 382			
	354.97	AS 383			
	380.37	AS 384			
	405.26	± 1.14	AS 385		
	430.66		AS 386		
	456.06		AS 387		
	481.46		AS 388		
506.86	AS 389				
532.26	AS 390				
557.66	AS 391				
582.68	± 1.52	AS 392			
608.08		AS 393			
633.48		AS 394			
658.88		AS 395			
6.98 ± 0.15	113.66	± 0.38	AS 425	88	
	116.84		AS 426	53	
	120.02		AS 427	54	
	123.19		AS 428	55	
	126.36		AS 429	56	
	129.54		AS 430	57	
	132.72	AS 431	58		
	135.89	AS 432	59		
	139.06	± 0.58	AS 433	60	
	142.24		AS 434	61	
	145.42		AS 435	62	
	148.59		AS 436	63	
	151.76		AS 437	64	

Note 1) The tolerance of bore diameter d_1 shows the specified values in JIS B 2401 for class 1-A and 1-B products. For class 4-D products, consult JTEKT.

d_2 (6.98)

unit : mm

O-ring dimensions		O-ring No.	Reference No.	
Cross section dia. d_2	Bore dia. $d_1^{1)}$		AN 6227	AN 6230
6.98 ± 0.15	158.12	± 0.58	AS 438	65
	164.46		AS 439	66
	170.82		AS 440	67
	177.16		AS 441	68
	183.52	± 0.76	AS 442	69
	189.86		AS 443	70
	196.22		AS 444	71
	202.56		AS 445	72
	215.26		AS 446	73
	227.96		AS 447	74
	240.66		AS 448	75
	253.36		AS 449	76
	266.06		AS 450	77
	278.76		AS 451	78
	291.46	AS 452	79	
	304.16	AS 453	80	
	316.86	± 0.76	AS 454	81
	329.56		AS 455	82
	342.26		AS 456	83
	354.96		AS 457	84
	367.66		AS 458	85
	380.36		AS 459	86
	393.06		AS 460	87
	405.26		± 1.14	AS 461
	417.96	AS 462		
	430.66	AS 463		
	443.36	AS 464		
	456.06	AS 465		
	468.76	AS 466		
	481.46	AS 467		
	494.16	AS 468		
	506.86	AS 469		
	532.46	AS 470		
	557.66	AS 471		
	582.68	± 1.52	AS 472	
	608.08		AS 473	
	633.48		AS 474	
	658.88		AS 475	

Backup Rings

P 3~165

JIS B 2407 P, G

Backup ring shape and dimensions

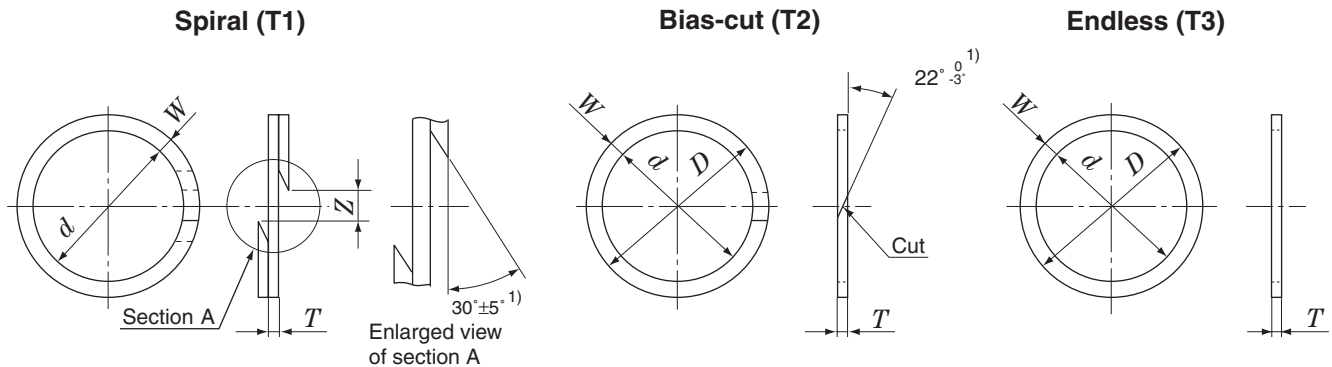

Remark) All rings material is tetrafluoroethylene resin.

P 3~34

unit : mm

Applied O-ring No.	Spiral ring					Bias-cut and Endless ring ²⁾						
	Backup ring No.	Dimensions				Backup ring No.		Dimensions				
		d	W ³⁾	T	Z ⁴⁾	Bias-cut	Endless	d	D	T		
P 3	T1 P 3	3	1.5 ^{+0.03} _{-0.06}	0.7 ± 0.05	1.2 ± 0.4	T2 P 3	T3 P 3	3	+0.15 0	6	0 -0.15	1.25 ± 0.1
P 4	T1 P 4	4				T2 P 4	T3 P 4	4		7		
P 5	T1 P 5	5				T2 P 5	T3 P 5	5		8		
P 6	T1 P 6	6				T2 P 6	T3 P 6	6		9		
P 7	T1 P 7	7				T2 P 7	T3 P 7	7		10		
P 8	T1 P 8	8				T2 P 8	T3 P 8	8		11		
P 9	T1 P 9	9				T2 P 9	T3 P 9	9		12		
P 10	T1 P 10	10				T2 P 10	T3 P 10	10		13		
P 10A	T1 P 10A	10				T2 P 10A	T3 P 10A	10		14		
P 11	T1 P 11	11				T2 P 11	T3 P 11	11		15		
P 11.2	T1 P 11.2	11.2	T2 P 11.2	T3 P 11.2	11.2	15.2						
P 12	T1 P 12	12	2.0 ^{+0.03} _{-0.06}	0.7 ± 0.05	1.4 ± 0.8	T2 P 12	T3 P 12	12	+0.20 0	16	0 -0.20	1.25 ± 0.1
P 12.5	T1 P 12.5	12.5				T2 P 12.5	T3 P 12.5	12.5		16.5		
P 14	T1 P 14	14				T2 P 14	T3 P 14	14		18		
P 15	T1 P 15	15				T2 P 15	T3 P 15	15		19		
P 16	T1 P 16	16				T2 P 16	T3 P 16	16		20		
P 18	T1 P 18	18				T2 P 18	T3 P 18	18		22		
P 20	T1 P 20	20				T2 P 20	T3 P 20	20		24		
P 21	T1 P 21	21				T2 P 21	T3 P 21	21		15		
P 22	T1 P 22	22				T2 P 22	T3 P 22	22		26		
P 22A	T1 P 22A	22				3.0 ^{+0.03} _{-0.06}	0.7 ± 0.05	2.5 ± 1.5		T2 P 22A		
P 22.4	T1 P 22.4	22.4	T2 P 22.4	T3 P 22.4	22.4				28.4			
P 24	T1 P 24	24	T2 P 24	T3 P 24	24				30			
P 25	T1 P 25	25	T2 P 25	T3 P 25	25				31			
P 25.5	T1 P 25.5	25.5	T2 P 25.5	T3 P 25.5	25.5				31.5			
P 26	T1 P 26	26	T2 P 26	T3 P 26	26				32			
P 28	T1 P 28	28	T2 P 28	T3 P 28	28				34			
P 29	T1 P 29	29	T2 P 29	T3 P 29	29				35			
P 29.5	T1 P 29.5	29.5	T2 P 29.5	T3 P 29.5	29.5				35.5			
P 30	T1 P 30	30	T2 P 30	T3 P 30	30				36			
P 31	T1 P 31	31	T2 P 31	T3 P 31	31	37						
P 31.5	T1 P 31.5	31.5	T2 P 31.5	T3 P 31.5	31.5	37.5						
P 32	T1 P 32	32	T2 P 32	T3 P 32	32	38						
P 34	T1 P 34	34	T2 P 34	T3 P 34	34	40						

- Notes
- 1) The cut angle for P3 to P10 is 35°~40°.
 - 2) The dimensions shown in the "Bias-cut and Endless ring" column are the dimensions of endless rings. Bias-cut rings are produced by cutting endless rings.
 - 3) In the case of bias-cut and endless ring, the deviation of ring thickness W (within one piece) shall be 0.05 mm max.
 - 4) The clearance Z is shown when the backup ring is installed on a shaft tolerated to 0 mm / -0.05 mm.

P 35~165

unit : mm

Applied O-ring No.	Spiral ring					Bias-cut and Endless ring ²⁾							
	Backup ring No.	Dimensions				Backup ring No.		Dimensions					
		<i>d</i>	<i>W</i> ³⁾	<i>T</i>	<i>Z</i> ⁴⁾	Bias-cut	Endless	<i>d</i>	<i>D</i>	<i>T</i>			
P 35	T1 P 35	35	3.0 +0.03 -0.06	0.7 ± 0.05	2.5 ± 1.5	T2 P 35	T3 P 35	35	+ 0.20 0	41	0	1.25 ± 0.1	
P 35.5	T1 P 35.5	35.5				T2 P 35.5	T3 P 35.5	35.5					41.5
P 36	T1 P 36	36				T2 P 36	T3 P 36	36					42
P 38	T1 P 38	38				T2 P 38	T3 P 38	38					44
P 39	T1 P 39	39				T2 P 39	T3 P 39	39					45
P 40	T1 P 40	40				T2 P 40	T3 P 40	40					46
P 41	T1 P 41	41				T2 P 41	T3 P 41	41					47
P 42	T1 P 42	42				T2 P 42	T3 P 42	42					48
P 44	T1 P 44	44				T2 P 44	T3 P 44	44					50
P 45	T1 P 45	45				T2 P 45	T3 P 45	45					51
P 46	T1 P 46	46	T2 P 46	T3 P 46	46	52							
P 48	T1 P 48	48	T2 P 48	T3 P 48	48	54							
P 49	T1 P 49	49	T2 P 49	T3 P 49	49	55							
P 50	T1 P 50	50	T2 P 50	T3 P 50	50	56							
P 48A	T1 P 48A	48	5.0 +0.03 -0.06	0.9 ± 0.06	4.5 ± 1.5	T2 P 48A	T3 P 48A	48	+ 0.25 0	58	0	1.9 ± 0.13	
P 50A	T1 P 50A	50				T2 P 50A	T3 P 50A	50					60
P 52	T1 P 52	52				T2 P 52	T3 P 52	52					62
P 53	T1 P 53	53				T2 P 53	T3 P 53	53					63
P 55	T1 P 55	55				T2 P 55	T3 P 55	55					65
P 56	T1 P 56	56				T2 P 56	T3 P 56	56					66
P 58	T1 P 58	58				T2 P 58	T3 P 58	58					68
P 60	T1 P 60	60				T2 P 60	T3 P 60	60					70
P 62	T1 P 62	62				T2 P 62	T3 P 62	62					72
P 63	T1 P 63	63				T2 P 63	T3 P 63	63					73
P 65	T1 P 65	65				T2 P 65	T3 P 65	65					75
P 67	T1 P 67	67				T2 P 67	T3 P 67	67					77
P 70	T1 P 70	70				T2 P 70	T3 P 70	70					80
P 71	T1 P 71	71				T2 P 71	T3 P 71	71					81
P 75	T1 P 75	75				T2 P 75	T3 P 75	75					85
P 80	T1 P 80	80				T2 P 80	T3 P 80	80					90
P 85	T1 P 85	85				T2 P 85	T3 P 85	85					95
P 90	T1 P 90	90				T2 P 90	T3 P 90	90					100
P 95	T1 P 95	95				T2 P 95	T3 P 95	95					105
P 100	T1 P 100	100				T2 P 100	T3 P 100	100					110
P 102	T1 P 102	102	T2 P 102	T3 P 102	102	112							
P 105	T1 P 105	105	T2 P 105	T3 P 105	105	115							
P 110	T1 P 110	110	T2 P 110	T3 P 110	110	120							
P 112	T1 P 112	112	T2 P 112	T3 P 112	112	122							
P 115	T1 P 115	115	T2 P 115	T3 P 115	115	125							
P 120	T1 P 120	120	T2 P 120	T3 P 120	120	130							
P 125	T1 P 125	125	T2 P 125	T3 P 125	125	135							
P 130	T1 P 130	130	T2 P 130	T3 P 130	130	140							
P 132	T1 P 132	132	T2 P 132	T3 P 132	132	142							
P 135	T1 P 135	135	T2 P 135	T3 P 135	135	145							
P 140	T1 P 140	140	T2 P 140	T3 P 140	140	150							
P 145	T1 P 145	145	T2 P 145	T3 P 145	145	155							
P 150	T1 P 150	150	T2 P 150	T3 P 150	150	160							
P 150A	T1 P 150A	150	7.5 +0.03 -0.06	1.4 ± 0.08	6.0 ± 2.0	T2 P 150A	T3 P 150A	150	+ 0.30 0	165	0	2.75 ± 0.15	
P 155	T1 P 155	155				T2 P 155	T3 P 155	155					170
P 160	T1 P 160	160				T2 P 160	T3 P 160	160					175
P 165	T1 P 165	165				T2 P 165	T3 P 165	165					180

Backup Rings

P 170~G 300

JIS B 2407 P, G

Backup ring shape and dimensions

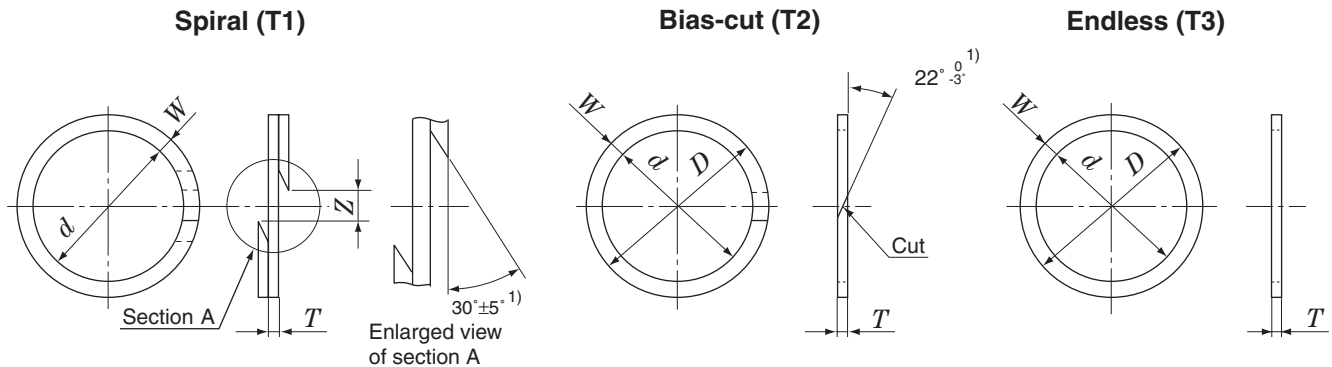

Remark) All rings material is tetrafluoroethylene resin.

P 170~360

unit : mm

Applied O-ring No.	Spiral ring					Bias-cut and Endless ring ²⁾				
	Backup ring No.	Dimensions				Backup ring No.		Dimensions		
		<i>d</i>	<i>W</i> ³⁾	<i>T</i>	<i>Z</i> ⁴⁾	Bias-cut	Endless	<i>d</i>	<i>D</i>	<i>T</i>
P 170	T1 P170	170	7.5 +0.03 -0.06	1.4 ± 0.08	6.0 ± 2.0	T2 P 170	T3 P 170	170	185	2.75 ± 0.15
P 175	T1 P175	175				T2 P 175	T3 P 175	175	190	
P 180	T1 P180	180				T2 P 180	T3 P 180	180	195	
P 185	T1 P185	185				T2 P 185	T3 P 185	185	200	
P 190	T1 P190	190				T2 P 190	T3 P 190	190	205	
P 195	T1 P195	195				T2 P 195	T3 P 195	195	210	
P 200	T1 P200	200				T2 P 200	T3 P 200	200	215	
P 205	T1 P205	205				T2 P 205	T3 P 205	205	220	
P 209	T1 P209	209				T2 P 209	T3 P 209	209	224	
P 210	T1 P210	210				T2 P 210	T3 P 210	210	225	
P 215	T1 P215	215				T2 P 215	T3 P 215	215	230	
P 220	T1 P220	220				T2 P 220	T3 P 220	220	235	
P 225	T1 P225	225				T2 P 225	T3 P 225	225	240	
P 230	T1 P230	230				T2 P 230	T3 P 230	230	245	
P 235	T1 P235	235				T2 P 235	T3 P 235	235	250	
P 240	T1 P240	240				T2 P 240	T3 P 240	240	255	
P 245	T1 P245	245				T2 P 245	T3 P 245	245	260	
P 250	T1 P250	250				T2 P 250	T3 P 250	250	265	
P 255	T1 P255	255				T2 P 255	T3 P 255	255	270	
P 260	T1 P260	260				T2 P 260	T3 P 260	260	275	
P 265	T1 P265	265				T2 P 265	T3 P 265	265	280	
P 270	T1 P270	270				T2 P 270	T3 P 270	270	285	
P 275	T1 P275	275				T2 P 275	T3 P 275	275	290	
P 280	T1 P280	280				T2 P 280	T3 P 280	280	295	
P 285	T1 P285	285				T2 P 285	T3 P 285	285	300	
P 290	T1 P290	290				T2 P 290	T3 P 290	290	305	
P 295	T1 P295	295				T2 P 295	T3 P 295	295	310	
P 300	T1 P300	300				T2 P 300	T3 P 300	300	315	
P 315	T1 P315	315				T2 P 315	T3 P 315	315	330	
P 320	T1 P320	320				T2 P 320	T3 P 320	320	335	
P 335	T1 P335	335				T2 P 335	T3 P 335	335	350	
P 340	T1 P340	340				T2 P 340	T3 P 340	340	355	
P 355	T1 P355	355				T2 P 355	T3 P 355	355	370	
P 360	T1 P360	360	T2 P 360	T3 P 360	360	375				

- Notes
- 1) The cut angle for P3 to P10 is 35°~ 40°.
 - 2) The dimensions shown in the "Bias-cut and Endless ring" column are the dimensions of endless rings. Bias-cut rings are produced by cutting endless rings.
 - 3) In the case of bias-cut and endless ring, the deviation of ring thickness *W* (within one piece) shall be 0.05 mm max.
 - 4) The clearance *Z* is shown when the backup ring is installed on a shaft tolerated to 0 mm / - 0.05 mm.

P 375~400

G 25~300

unit : mm

Applied O-ring No.	Spiral ring					Bias-cut and Endless ring ²⁾						
	Backup ring No.	Dimensions				Backup ring No.		Dimensions				
		<i>d</i>	<i>W</i> ³⁾	<i>T</i>	<i>Z</i> ⁴⁾	Bias-cut	Endless	<i>d</i>	<i>D</i>	<i>T</i>		
P 375	T1 P 375	375	7.5 +0.03 -0.06	1.4 ± 0.08	6.0 ± 2.0	T2 P 375	T3 P 375	375	+ 0.30 0	390	0 - 0.30	2.75 ± 0.15
P 385	T1 P 385	385				T2 P 385	T3 P 385	385		400		
P 400	T1 P 400	400				T2 P 400	T3 P 400	400		415		
G 25	T1 G 25	25	2.5 +0.03 -0.06	0.7 ± 0.05	4.5 ± 1.5	T2 G 25	T3 G 25	25	+ 0.20 0	30	0 - 0.20	1.25 ± 0.1
G 30	T1 G 30	30				T2 G 30	T3 G 30	30		35		
G 35	T1 G 35	35				T2 G 35	T3 G 35	35		40		
G 40	T1 G 40	40				T2 G 40	T3 G 40	40	45			
G 45	T1 G 45	45				T2 G 45	T3 G 45	45	50			
G 50	T1 G 50	50				T2 G 50	T3 G 50	50	55			
G 55	T1 G 55	55				T2 G 55	T3 G 55	55	60			
G 60	T1 G 60	60				T2 G 60	T3 G 60	60	65			
G 65	T1 G 65	65				T2 G 65	T3 G 65	65	70			
G 70	T1 G 70	70				T2 G 70	T3 G 70	70	75			
G 75	T1 G 75	75				T2 G 75	T3 G 75	75	80			
G 80	T1 G 80	80				T2 G 80	T3 G 80	80	85			
G 85	T1 G 85	85				T2 G 85	T3 G 85	85	90			
G 90	T1 G 90	90				T2 G 90	T3 G 90	90	95			
G 95	T1 G 95	95				T2 G 95	T3 G 95	95	100			
G 100	T1 G 100	100	5.0 +0.03 -0.06	0.9 ± 0.06	6.0 ± 2.0	T2 G 100	T3 G 100	100	+ 0.25 0	105	0 - 0.25	1.25 ± 0.1
G 105	T1 G 105	105				T2 G 105	T3 G 105	105		110		
G 110	T1 G 110	110				T2 G 110	T3 G 110	110		115		
G 115	T1 G 115	115				T2 G 115	T3 G 115	115	120			
G 120	T1 G 120	120				T2 G 120	T3 G 120	120	125			
G 125	T1 G 125	125				T2 G 125	T3 G 125	125	130			
G 130	T1 G 130	130				T2 G 130	T3 G 130	130	135			
G 135	T1 G 135	135				T2 G 135	T3 G 135	135	140			
G 140	T1 G 140	140				T2 G 140	T3 G 140	140	145			
G 145	T1 G 145	145				T2 G 145	T3 G 145	145	150			
G 150	T1 G 150	150				T2 G 150	T3 G 150	150	160			
G 155	T1 G 155	155				T2 G 155	T3 G 155	155	165			
G 160	T1 G 160	160				T2 G 160	T3 G 160	160	170			
G 165	T1 G 165	165				T2 G 165	T3 G 165	165	175			
G 170	T1 G 170	170				T2 G 170	T3 G 170	170	180			
G 175	T1 G 175	175	T2 G 175	T3 G 175	175	185						
G 180	T1 G 180	180	T2 G 180	T3 G 180	180	190						
G 185	T1 G 185	185	T2 G 185	T3 G 185	185	195						
G 190	T1 G 190	190	T2 G 190	T3 G 190	190	200						
G 195	T1 G 195	195	T2 G 195	T3 G 195	195	205						
G 200	T1 G 200	200	5.0 +0.03 -0.06	0.9 ± 0.06	6.0 ± 2.0	T2 G 200	T3 G 200	200	+ 0.30 0	210	0 - 0.30	1.9 ± 0.13
G 210	T1 G 210	210				T2 G 210	T3 G 210	210		220		
G 220	T1 G 220	220				T2 G 220	T3 G 220	220		230		
G 230	T1 G 230	230				T2 G 230	T3 G 230	230	240			
G 240	T1 G 240	240				T2 G 240	T3 G 240	240	250			
G 250	T1 G 250	250				T2 G 250	T3 G 250	250	260			
G 260	T1 G 260	260				T2 G 260	T3 G 260	260	270			
G 270	T1 G 270	270				T2 G 270	T3 G 270	270	280			
G 280	T1 G 280	280				T2 G 280	T3 G 280	280	290			
G 290	T1 G 290	290				T2 G 290	T3 G 290	290	300			
G 300	T1 G 300	300				T2 G 300	T3 G 300	300	310			

V

15~1 055

JIS B 2401

V (for Vacuum Flanges)

Material : JIS classes 1-A, 1-B, 2, 3, 4-C and 4-D

■ O-ring shape and dimensions (unit : mm)

■ Fitting groove dimensions

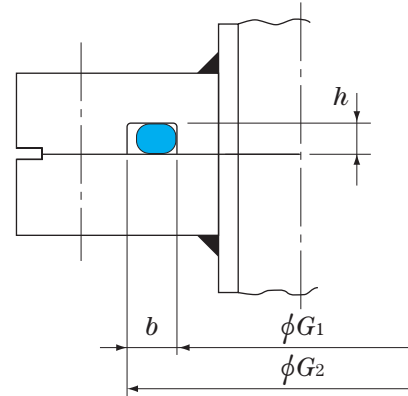
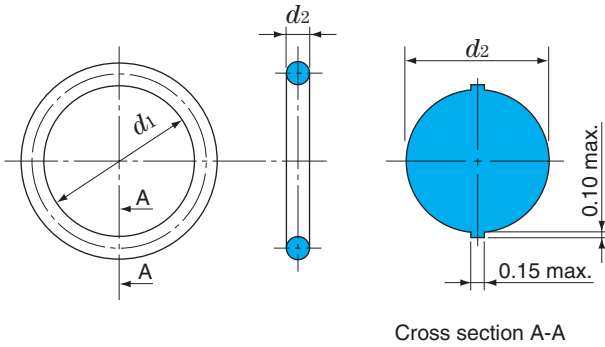

V 15~1 055

unit : mm

O-ring dimensions		O-ring No.	Groove dimensions				
Bore dia. d_1 ¹⁾	Cross section dia. d_2		G_1		G_2	b ^{+0.1} ₀	h ⁰ _{-0.2}
14.5	± 0.20	V 15	15	+ 1.0 0	25	5.0	3.0
23.5	± 0.24	V 24	24		34		
33.5	± 0.33	V 34	34		44		
39.5	± 0.37	V 40	40		50		
54.5	± 0.49	V 55	55		65		
69.0	± 0.61	V 70	70		80		
84.0	± 0.72	V 85	85		95		
99.0	± 0.83	V 100	100		110		
119.0	± 0.97	V 120	120		130		
148.5	± 1.18	V 150	150		160		
173.0	± 1.36	V 175	175	185			
222.5	± 1.70	V 225	225	+ 1.5 0	241	8.0	4.5
272.0	± 2.02	V 275	275		291		
321.5	± 2.34	V 325	325		341		
376.0	± 2.68	V 380	380		396		
425.5	± 2.99	V 430	430		446		
475.0	± 3.30	V 480	480	+ 2.0 0	504	12.0	7.0
524.5	± 3.60	V 530	530		554		
579.0	± 3.92	V 585	585		609		
633.5	± 4.24	V 640	640		664		
683.0	± 4.54	V 690	690		714		
732.5	± 4.83	V 740	740		764		
782.0	± 5.12	V 790	790		814		
836.5	± 5.44	V 845	845		864		
940.5	± 6.06	V 950	950	974			
1 044.0	± 6.67	V 1 055	1 055	1 079			

Note 1) The tolerance of bore diameter d_1 shows the specified values in JIS B 2401 for class 1-A, 1-B, 2 and 3 products. For class 4-C products, the tolerance is 1.5 times these values, and for class 4-D products, 1.2 times.

3

Application Examples of Oil Seals and O-Rings

3.1 Automobile	138
■ Automatic transmission	
■ Manual transmission	
■ Engine	
■ Power steering	
■ Driving wheel	
■ Driven wheel	
3.2 Motorcycle	141
■ Engine	
3.3 Rolling mill roll necks	142
■ Rolling bearing	
■ Oil-film bearing	
3.4 Rolling stock axles	143
■ Double row tapered roller bearing	
■ Double row cylindrical roller bearing	
3.5 Geared motor	144
3.6 Hydraulic motor	144

3.1 Automobile

Automatic transmission

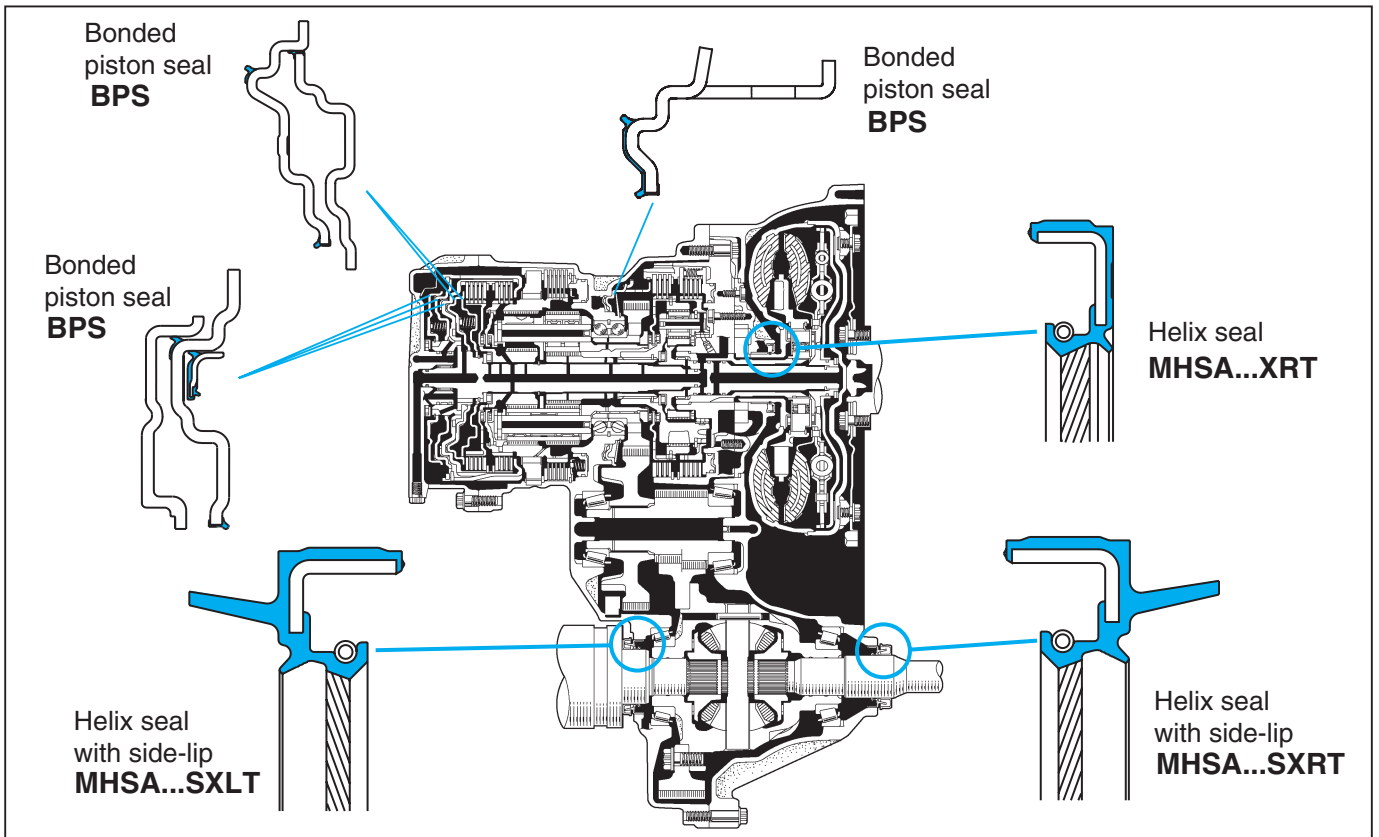

Manual transmission

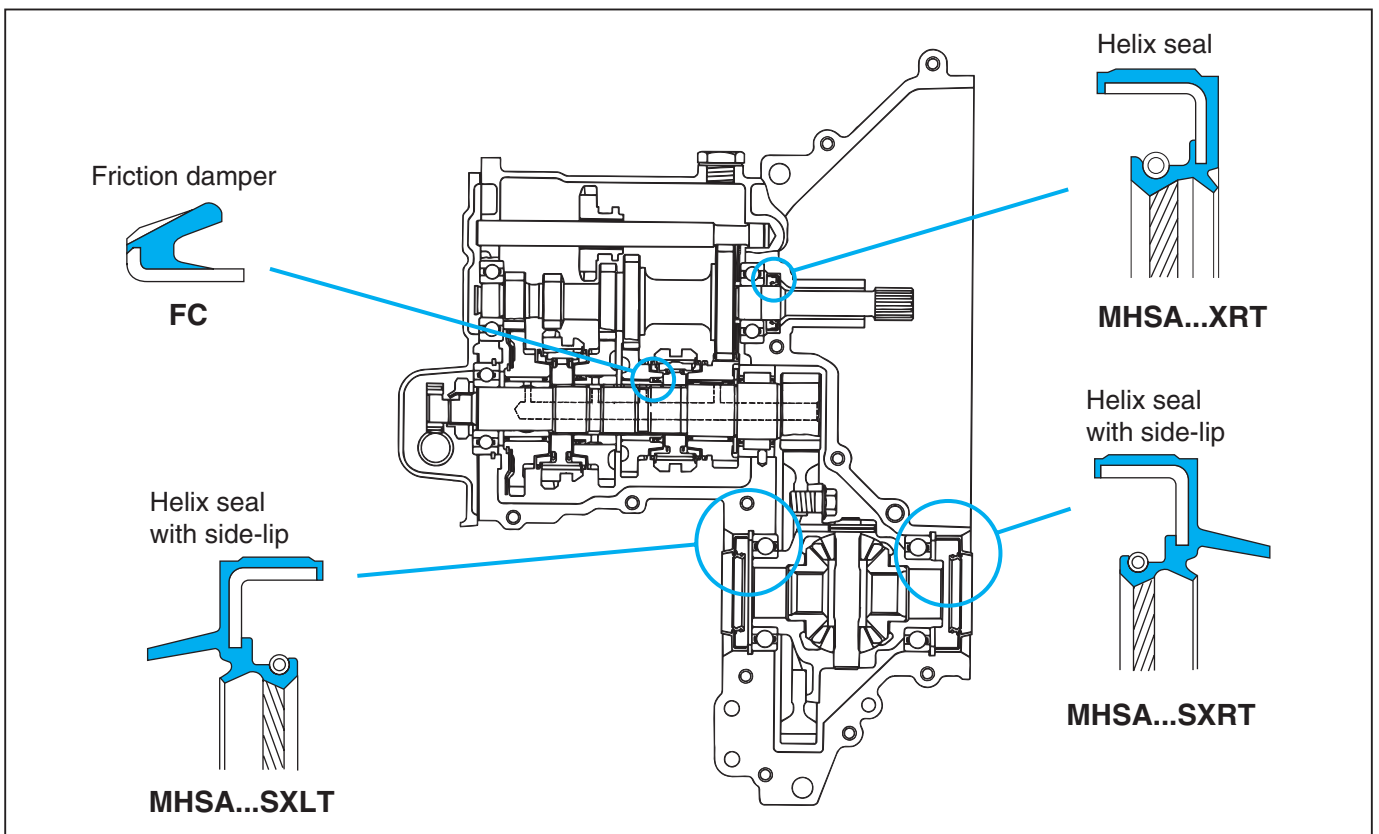

■ Engine

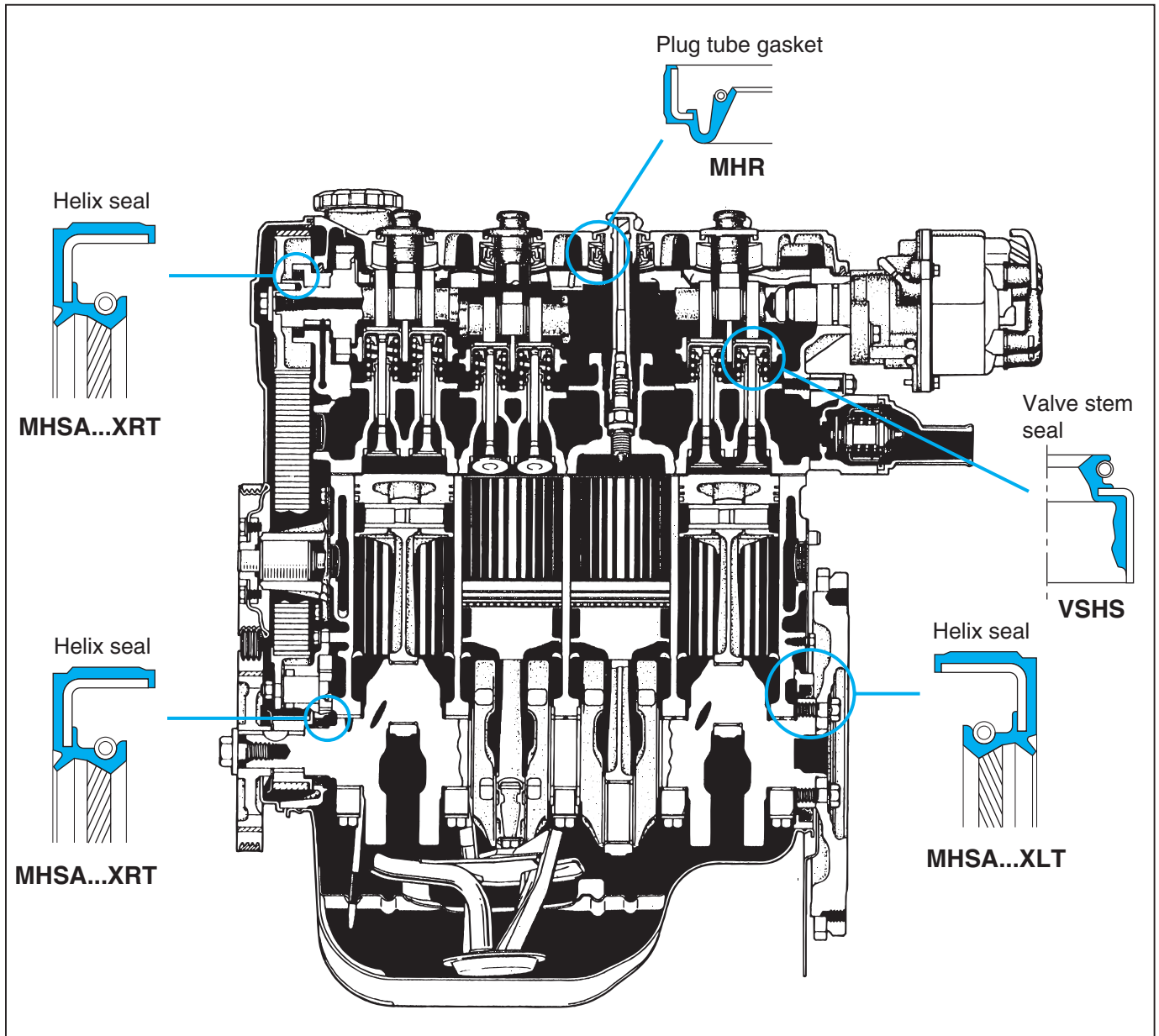

■ Power steering

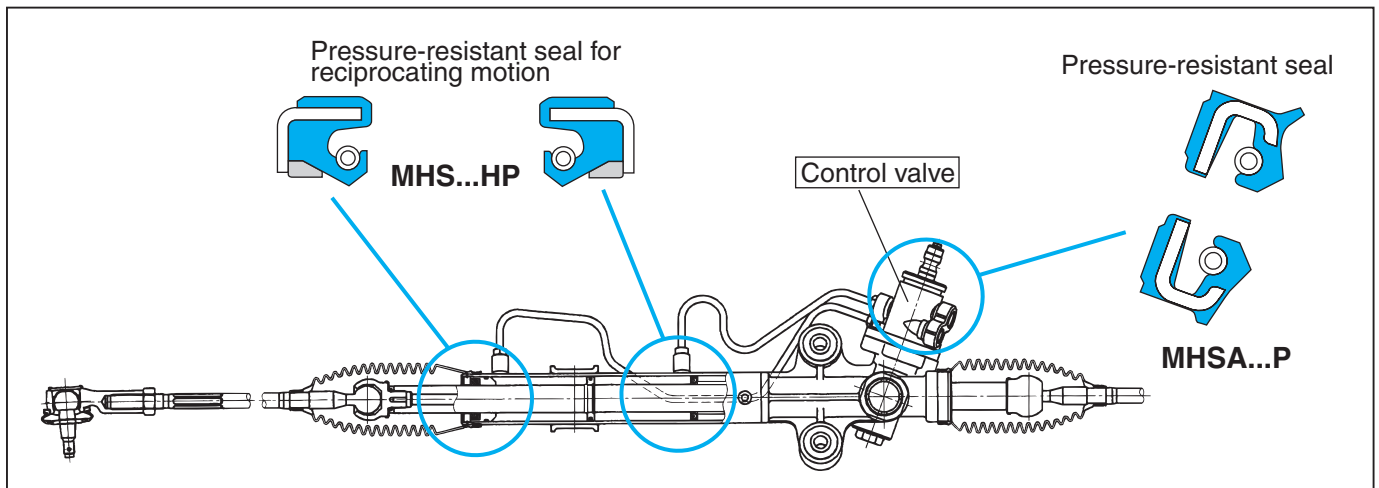

3. Application Examples of Oil Seals and O-Rings

Driving wheel

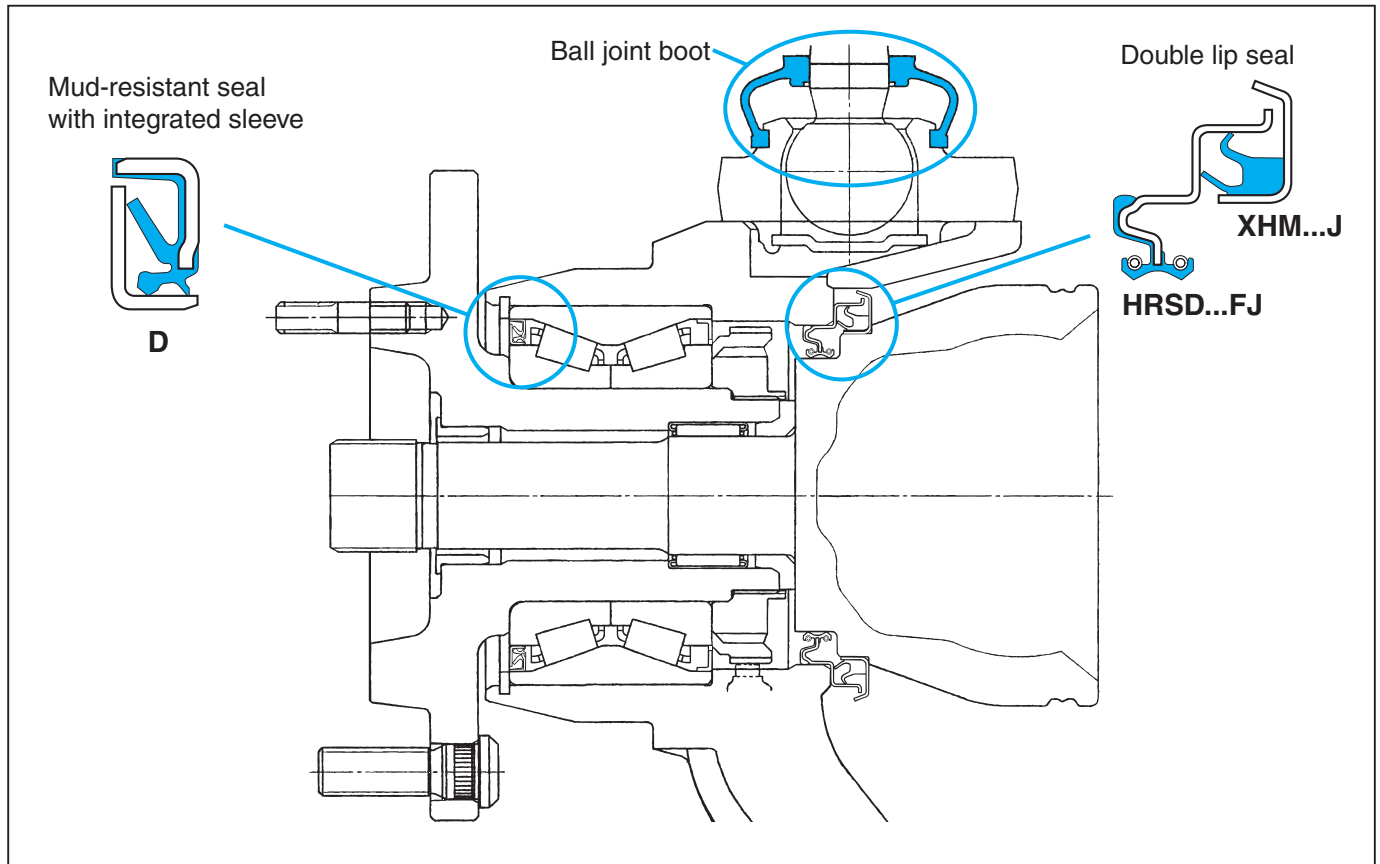

Driven wheel

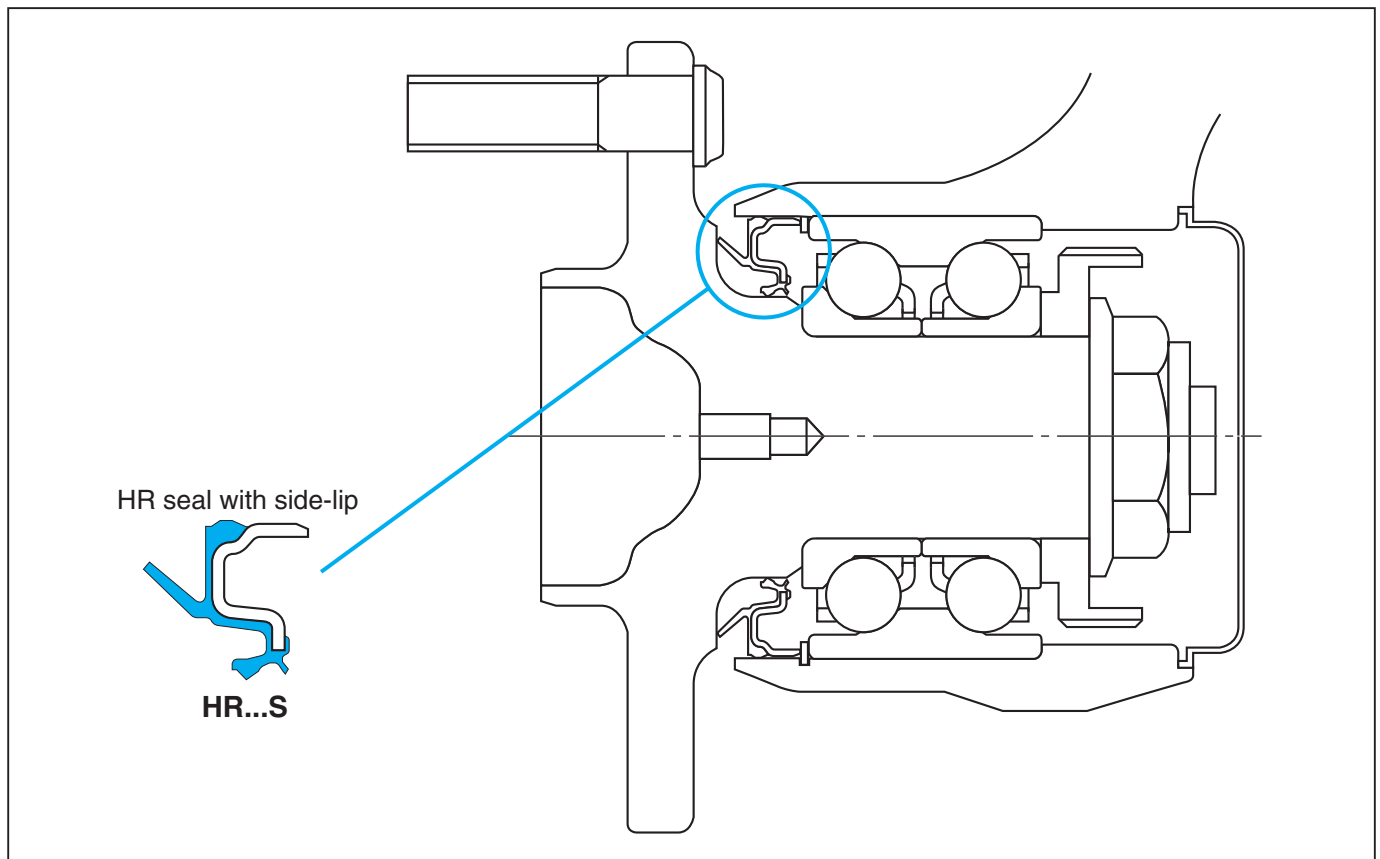

3.2 Motorcycle

■ Engine

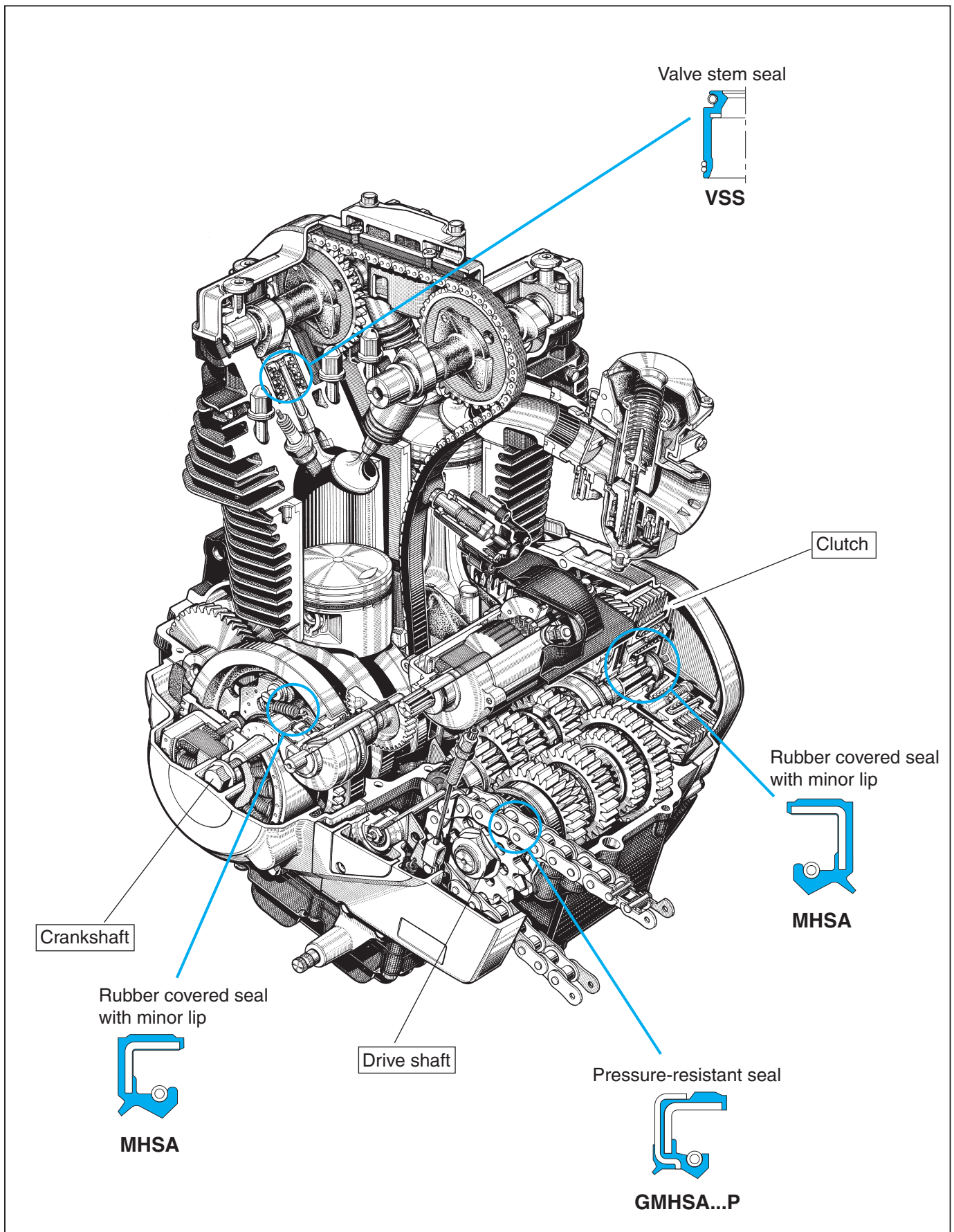

3.3 Rolling mill roll necks

Rolling bearing

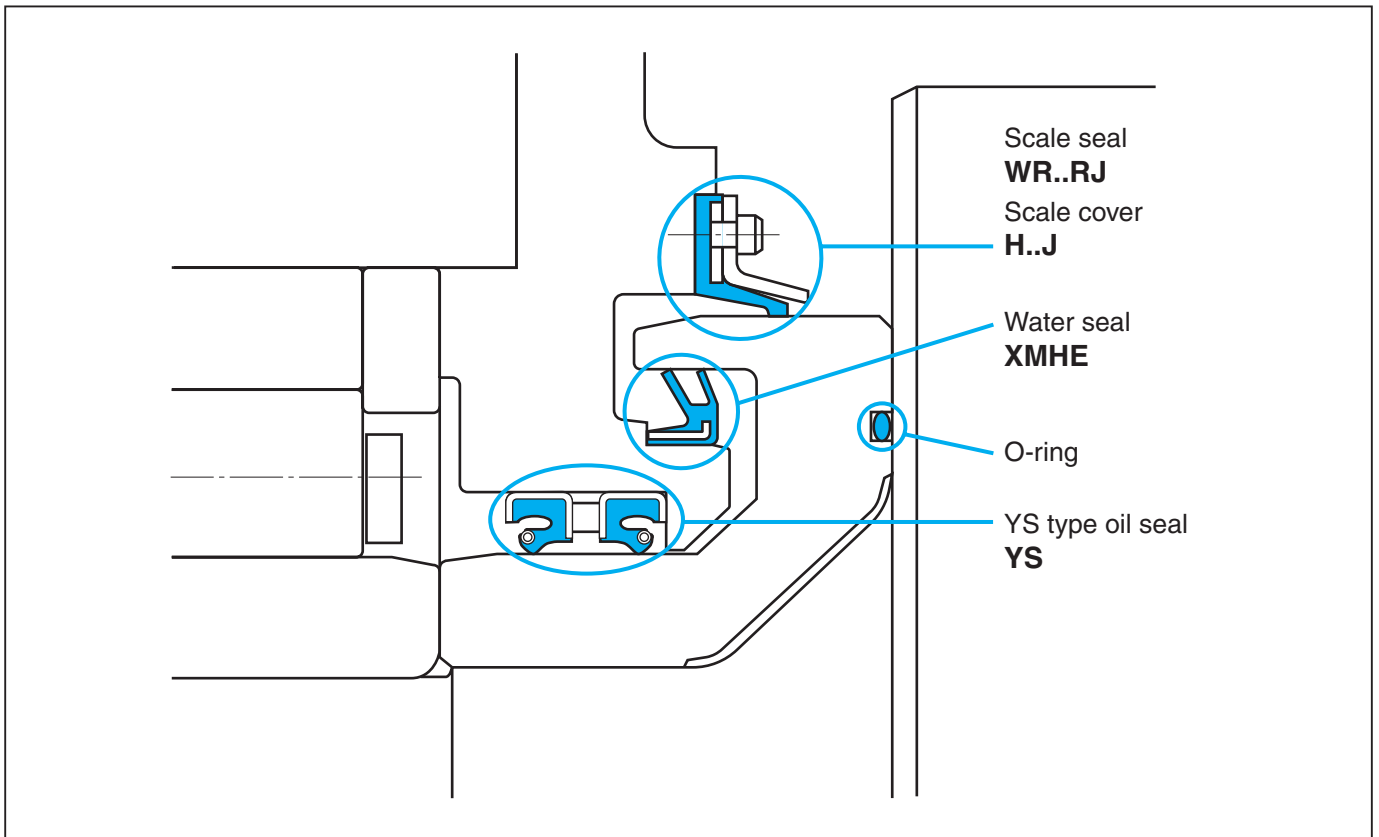

Oil-film bearing

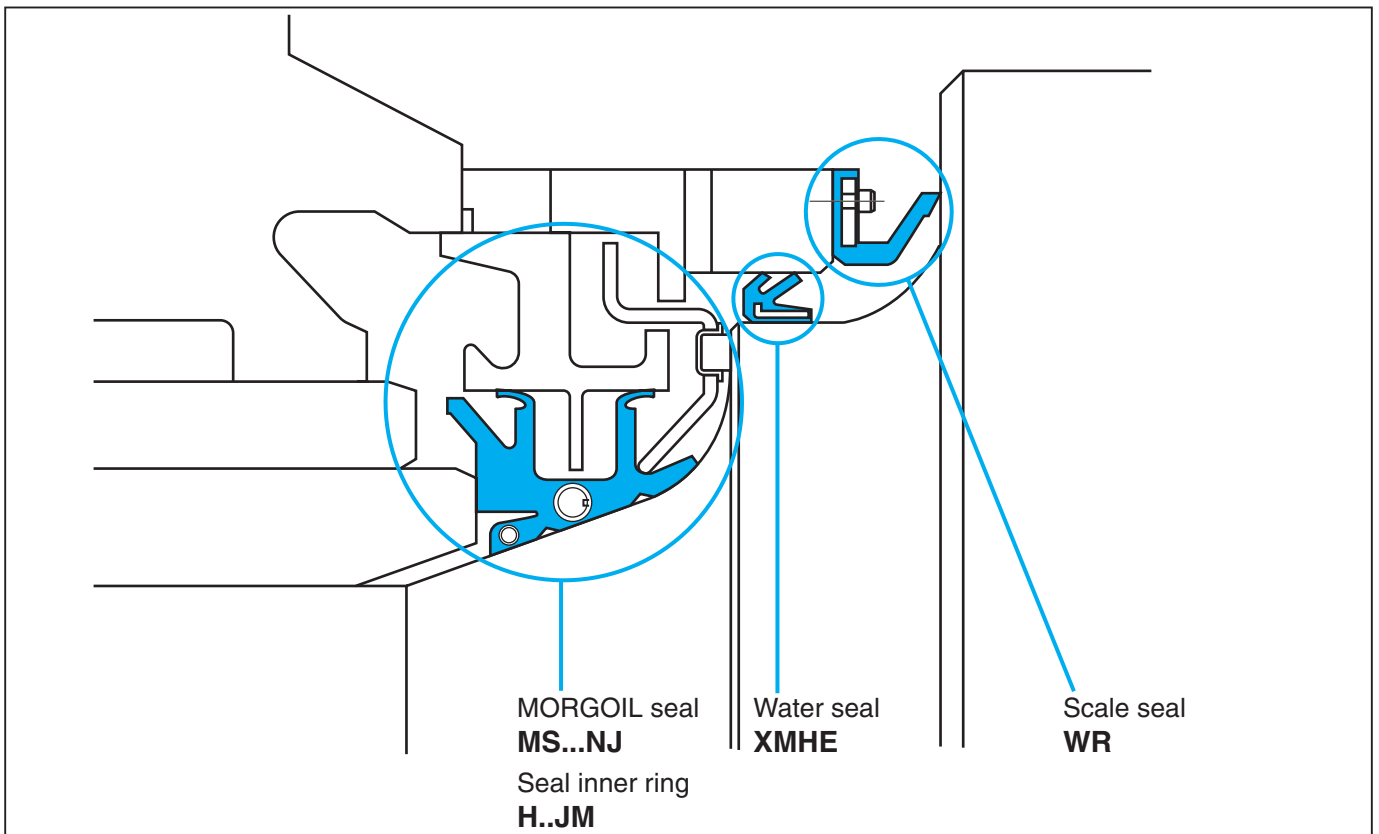

3.4 Rolling stock axles

■ Double row tapered roller bearing

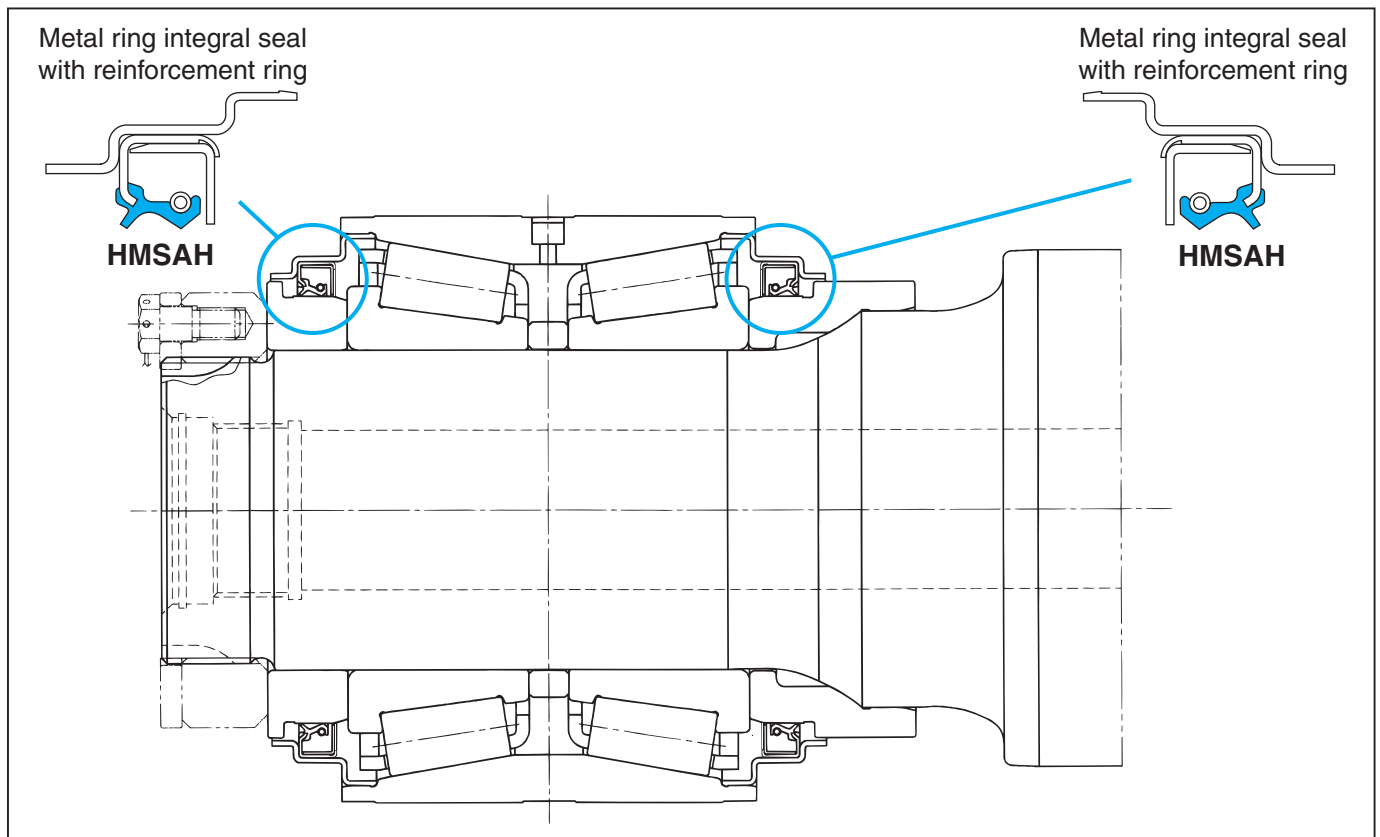

■ Double row cylindrical roller bearing

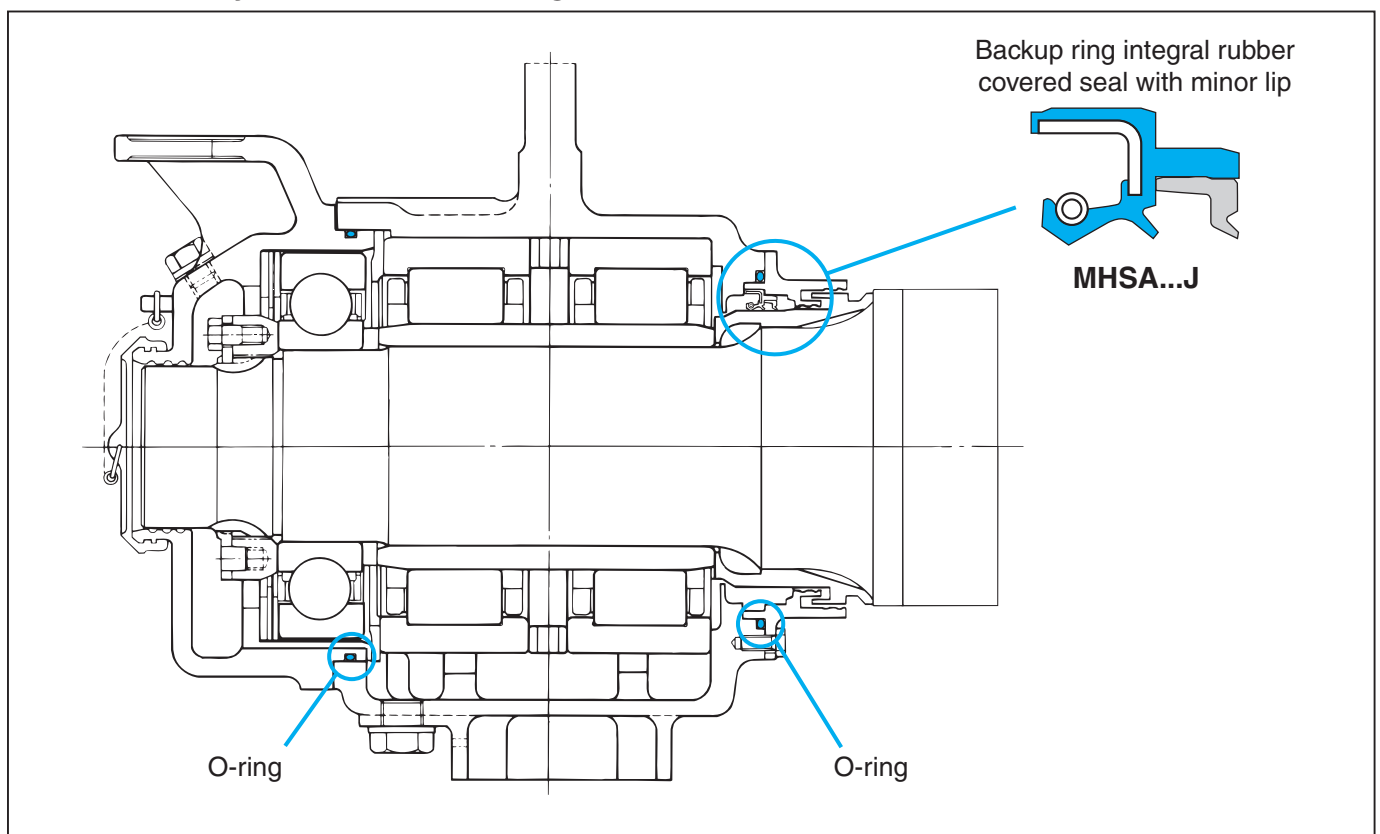

3.5 Geared motor

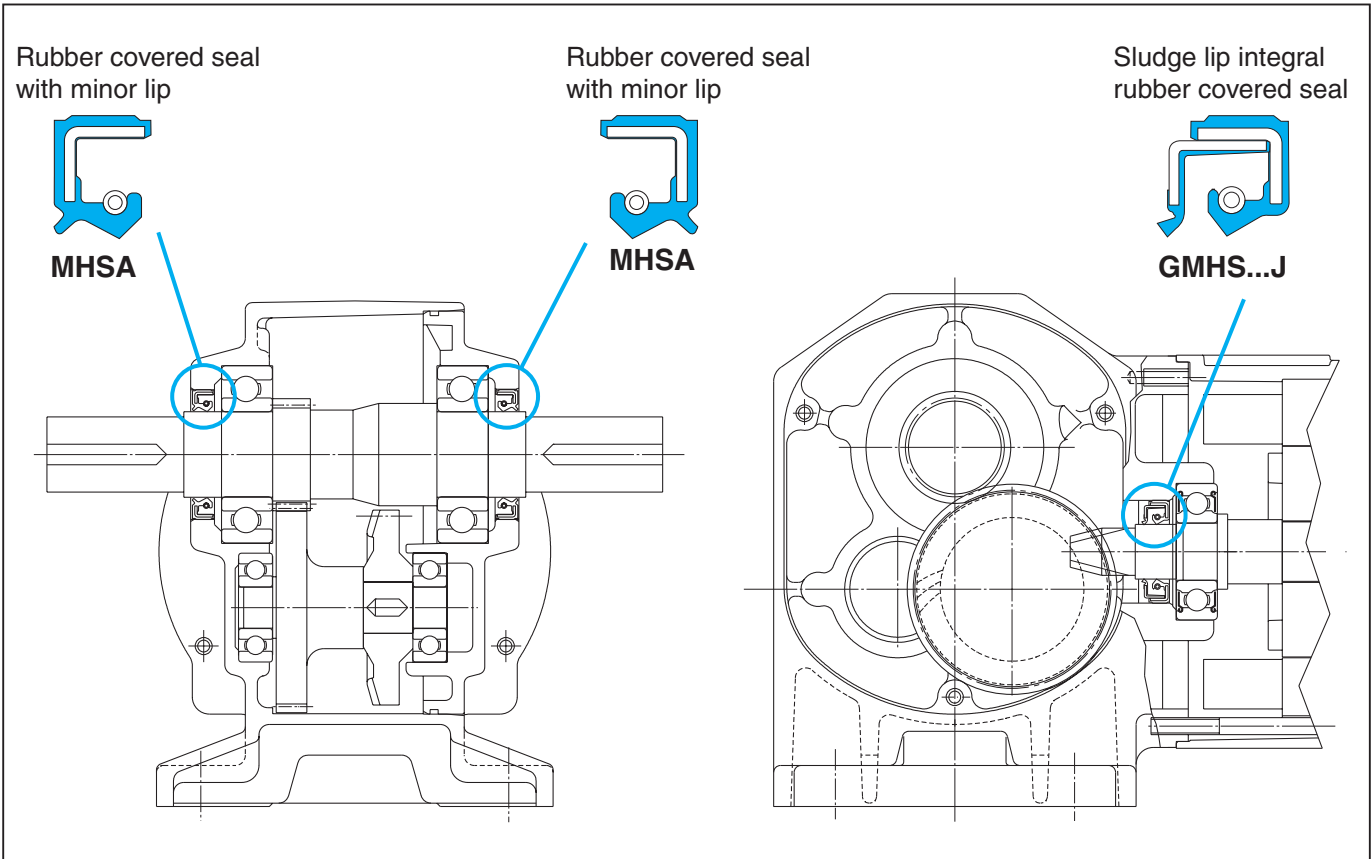

3.6 Hydraulic motor

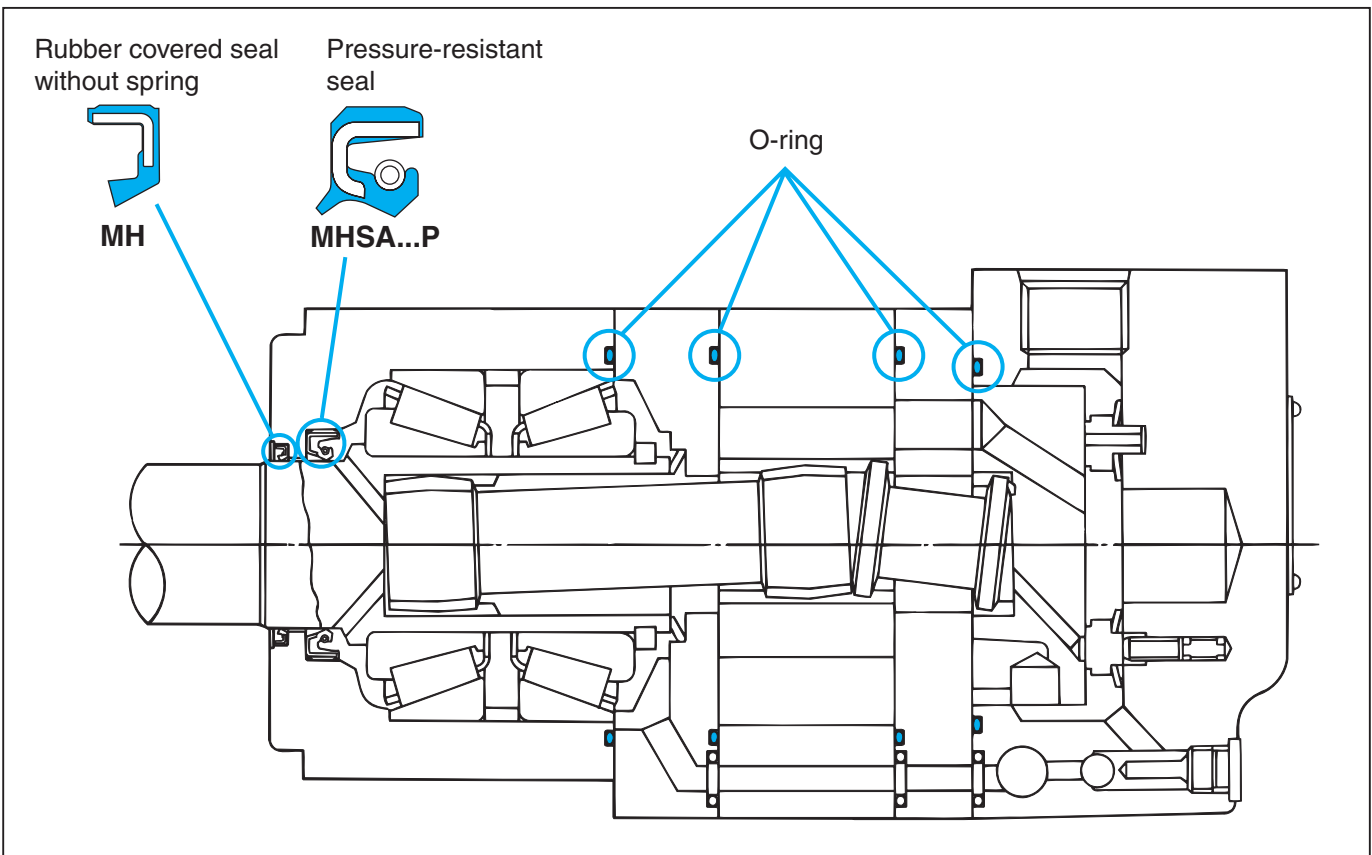

4

References

4.1 Rubber-material varieties and properties	146
4.2 SI units and conversion factors	148
4.3 Shaft tolerance	152
4.4 Housing bore tolerance	154
4.5 °C-°F temperature conversion table	156
4.6 Steel hardness conversion table	157
4.7 Viscosity conversion table	158
4.8 Shaft surface speed –Quick reference diagram–	159

5

Request Forms for Oil Seal Design and Production

..... 160

4.1 Rubber-material varieties and properties

This table compares the properties of all available rubber materials, including those that are not suitable for oil seals and O-rings.

⊙ : Resistant to the substance.
 ○ : Resistant to the substance except under extreme conditions.
 △ : Not resistant to the substance except under specific favorable conditions.
 × : Not resistant to the substance.

Kind of rubber (ASTM code)		Nitrile rubber (NBR)	Hydrogenated nitrile rubber (HNBR)	Acrylic rubber (ACM and ANM)	Silicone rubber (VMQ)	Fluorocarbon rubber (FKM)	Chloroprene rubber (CR)	Ethylene-propylene rubber (EPM and EPDM)	Styrene-butadiene rubber (SBR)	Urethane rubber (U)	Natural rubber and isoprene rubber (NR and IR)	Butadiene rubber (BR)	Butyl rubber (IIR)	Chlorosulfonated polyethylene rubber (CSM)
Chemical structure		Acrylonitrile-butadiene copolymer	Hydrogenated acrylonitrile-butadiene copolymer	Acrylic-ester copolymer	Organopolysiloxane	Hexafluoropropylene-vinylidene-fluoride copolymer	Polychloroprene	Ethylene-propylene copolymer	Styrene-butadiene copolymer	Polyurethane	Polyisoprene	Polybutadiene	Isobutylene-isoprene copolymer	Chlorosulfonated polyethylene
Raw-rubber properties	Specific gravity	0.96 ~ 1.02	0.98 ~ 1.00	1.09 ~ 1.10	0.95 ~ 0.98	1.80 ~ 1.82	1.15 ~ 1.25	0.86 ~ 0.87	0.92 ~ 0.97	1.00 ~ 1.30	0.92	0.91 ~ 0.94	0.91 ~ 0.93	1.11 ~ 1.18
	Mooney viscosity ML ₁₊₄ (100 °C)	30 ~ 130	65 ~ 85	45 ~ 60	Liquid	35 ~ 160	45 ~ 120	40 ~ 100	30 ~ 70	25 ~ 60 (or liquid)	45 ~ 150	35 ~ 55	45 ~ 80	30 ~ 115
Compounded-rubber physical and resistance properties	Applicable JIS hardness range ¹⁾	20 ~ 100	40 ~ 100	40 ~ 90	30 ~ 90	50 ~ 90	10 ~ 90	30 ~ 90	30 ~ 100	60 ~ 100	10 ~ 100	30 ~ 100	20 ~ 90	50 ~ 90
	Tensile strength (MPa)	5 ~ 25	5 ~ 30	7 ~ 12	3 ~ 12	7 ~ 20	5 ~ 25	5 ~ 20	2 ~ 30	20 ~ 45	3 ~ 35	2 ~ 20	5 ~ 20	7 ~ 20
	Elongation (%)	800 ~ 100	800 ~ 100	600 ~ 100	500 ~ 50	500 ~ 100	1 000 ~ 100	800 ~ 100	800 ~ 100	800 ~ 300	1 000 ~ 100	800 ~ 100	800 ~ 100	500 ~ 100
	Impact resilience	○	○	△	⊙	△	⊙	○	○	⊙	⊙	⊙	△	○
	Tear strength	○	○	△	× ~ △	○	○	△	△	⊙	⊙	○	○	○
	Abrasion resistance	⊙	⊙	○	× ~ △	⊙	○ ~ ⊙	○	⊙	⊙	⊙	⊙	○	⊙
	Flex crack resistance	○	○	○	× ~ ○	○	○	○	○	⊙	⊙	△	⊙	○
	Servisable temperature range (°C)	-50 ~ 120	-40 ~ 160	-30 ~ 180	-80 ~ 250	-30 ~ 250	-60 ~ 120	-60 ~ 150	-60 ~ 70	-60 ~ 80	-75 ~ 90	-100 ~ 100	-60 ~ 150	-60 ~ 150
	Aging resistance	⊙	⊙	⊙	⊙	⊙	⊙	⊙	○	○	○	○	⊙	⊙
	Resistance to weather	○	⊙	⊙	⊙	⊙	⊙	⊙	○	⊙	○	○	⊙	⊙
Ozone resistance	×	○	⊙	⊙	⊙	⊙	⊙	×	⊙	×	×	⊙	⊙	
Flame resistance	× ~ △	× ~ △	× ~ △	× ~ ○	⊙	○	○	×	×	×	×	×	○	
Electrical insulation (Ω · cm) (volume resistivity)	10 ² ~ 10 ¹¹	—	10 ⁸ ~ 10 ¹⁰	10 ¹¹ ~ 10 ¹⁶	10 ¹⁰ ~ 10 ¹⁴	10 ¹⁰ ~ 10 ¹²	10 ¹² ~ 10 ¹⁶	10 ¹⁰ ~ 10 ¹⁵	10 ⁹ ~ 10 ¹²	10 ¹⁰ ~ 10 ¹⁵	10 ¹⁴ ~ 10 ¹⁵	10 ¹⁶ ~ 10 ¹⁸	10 ¹² ~ 10 ¹⁴	
Gas permeability (10 ⁻¹⁶ m ⁴ /N · s)	0.03 ~ 0.35	—	1	40	0.1	0.3	1.5	1.2	0.2	1.8	1.3 ~ 5	0.09 ~ 0.1	0.3	
Radiation resistance	△ ~ ○	△ ~ ○	× ~ ○	△ ~ ⊙	△ ~ ○	△ ~ ○	×	○	○	△ ~ ○	×	×	△ ~ ○	
Compound-rubber chemical resistance	Gasoline and light oil	⊙	⊙	⊙	× ~ △	⊙	○	×	×	⊙	×	×	×	△
	Benzene and toluene	× ~ △	× ~ △	×	× ~ △	⊙	×	△	×	×	×	×	△ ~ ○	×
	Alcohol	⊙	⊙	×	⊙	⊙	⊙	⊙	⊙	△	⊙	⊙	⊙	⊙
	Ether	× ~ △	× ~ △	×	× ~ △	×	×	○	×	×	×	×	△ ~ ○	×
	Ketone (MEK)	×	×	×	○	×	△ ~ ○	⊙	△ ~ ○	×	△ ~ ○	△ ~ ○	⊙	△ ~ ○
	Ethyl acetate	× ~ △	× ~ △	×	△ ~ ⊙	×	×	⊙	×	△	×	×	⊙	×
	Water	⊙	⊙	△	○	⊙	⊙	⊙	⊙	△	⊙	⊙	⊙	⊙
	Organic acid	× ~ △	× ~ △	×	○	×	×	×	×	×	×	×	△ ~ ○	△
	Concentrate inorganic acid solution	○	○	△	△	⊙	○	○	△	×	△	△	⊙	⊙
	Dilute inorganic acid solution	○	○	○	○	⊙	⊙	⊙	○	△	○	○	⊙	⊙
Concentrate inorganic alkaline solution	○	○	△	⊙	×	⊙	⊙	○	×	○	○	⊙	⊙	
Dilute inorganic alkaline solution	○	○	○	⊙	△	⊙	⊙	○	×	○	○	⊙	⊙	
Typical properties and major applications		The most common oil-resistant rubber material. Good resistance to abrasion. Widely used for oil seals and O-rings.	Excellent heat resistance and mechanical strength, in addition to having properties of nitrile rubber. An optimal material for oil seals for high-temperature or hydraulic applications.	Compared with nitrile rubber, superior in aging resistance. Suitable for sealing hydraulic fluids. Commonly used in automotive applications such as transmission, crankshaft, and valve stem.	Siloxane-based, excellent heat resistance and low-temperature resistance. Suitable for extreme-temperature environments and food processing applications.	Most excellent in resistance against various severe conditions. Optimal for use in proximity to engines.	Well-balanced in resistance to weather, oil and heat. Commonly used to isolate vibration and to coat wires. Some cases used for oil seals and O-rings.	Excellent weatherproof and water-proof. It is used for clad automobiles and wires.	Compared with natural rubber, superior in resistance to abrasion and aging. Used as the material of tires and belts.	Superior mechanical strength and oil resistance, however relatively low heat resistance and water-proofness. Used in applications where heat resistance is not essential.	Excellent resilience and superior abrasion resistance. Oil resistance is relatively low. Used for tires and shoes.	Excellent in resilience and mechanical strength. But inferior in resistance to oil and to pressure. Used for produce tires and sport goods.	Low gas permeability and inferior in resilience. Commonly used for tubes and vibration isolators.	Superior aging resistance and chemical resistance. Used for hoses and cladding.

Note 1) Hardness measured by durometer.

References : Japanese Standards Association. Shinban Gomu Zairyo Sentaku no Pointo ("Rubber Material Selection Guidelines, Rev. "). Society of Rubber Industry, Japan. Gomu Kogyo Binran ("Rubber Industry Handbook"), 4th ed.

4.2 SI units and conversion factors

SI units and conversion factors (1)

Mass	SI units	Other Units ¹⁾	Conversion into SI units	Conversion from SI units
Angle	rad [radian(s)]	° [degree(s)] * ' [minute(s)] * " [second(s)] *	1° = π / 180 rad 1' = π / 10 800 rad 1" = π / 648 000 rad	1 rad = 57.295 78°
Length	m [meter(s)]	Å [Angstrom unit] μ [micron(s)] in [inch(es)] ft [foot(feet)] yd [yard(s)] mile [mile(s)]	1Å = 10 ⁻¹⁰ m = 0.1 nm = 100 pm 1μ = 1μm 1 in = 25.4 mm 1 ft = 12 in = 0.304 8 m 1 yd = 3 ft = 0.914 4 m 1 mile = 5 280 ft = 1 609.344 m	1 m = 10 ¹⁰ Å 1 m = 39.37 in 1 m = 3.280 8 ft 1 m = 1.093 6 yd 1 km = 0.621 4 mile
Area	m ²	a [are(s)] ha [hectare(s)] acre [acre(s)]	1 a = 100 m ² 1 ha = 10 ⁴ m ² 1 acre = 4 840 yd ² = 4 046.86 m ²	1 km ² = 247.1 acre
Volume	m ³	ℓ , L [liter(s)] * cc [cubic centimeters] gal (US) [gallon(s)] floz (US) [fluid ounce(s)] barrel (US) [barrels(US)]	1 ℓ = 1 dm ³ = 10 ⁻³ m ³ 1 cc = 1 cm ³ = 10 ⁻⁶ m ³ 1 gal (US) = 231 in ³ = 3.785 41 dm ³ 1 floz (US) = 29.573 5 cm ³ 1 barrel (US) = 158.987 dm ³	1 m ³ = 10 ³ ℓ 1 m ³ = 10 ⁶ cc 1 m ³ = 264.17 gal 1 m ³ = 33 814 floz 1 m ³ = 6.289 8 barrel
Time	s [second(s)]	min [minute(s)] * h [hour(s)] * d [day(s)] *		
Angular velocity	rad/s			
Velocity	m/s	kn [knot(s)] * m/h *	1 kn = 1 852 m/h	1 km/h = 0.539 96 kn
Acceleration	m/s ²	G	1 G = 9.806 65 m/s ²	1 m/s ² = 0.101 97 G
Frequency	Hz [hertz]	c/s [cycle(s)/second]	1 c/s = 1 s ⁻¹ = 1 Hz	
Rotational frequency	s ⁻¹	rpm [revolutions per minute] min ⁻¹ * r/min	1 rpm = 1/60 s ⁻¹	1 s ⁻¹ = 60 rpm
Mass	kg [kilogram(s)]	t [ton(s)] * lb [pound(s)] gr [grain(s)] oz [ounce(s)] ton (UK) [ton(s) (UK)] ton (US) [ton(s) (US)] car [carat(s)]	1 t = 10 ³ kg 1 lb = 0.453 592 37 kg 1 gr = 64.798 91 mg 1 oz = 1/16 lb = 28.349 5 g 1 ton (UK) = 1 016.05 kg 1 ton (US) = 907.185 kg 1 car = 200 mg	1 kg = 2.204 6 lb 1 g = 15.432 4 gr 1 kg = 35.274 0 oz 1 t = 0.984 2 ton (UK) 1 t = 1.102 3 ton (US) 1 g = 5 car

Note 1) * : Unit can be used as an SI unit.
No asterisk : Unit cannot be used.

SI units and conversion factors (2)

Mass	SI units	Other Units ¹⁾	Conversion into SI units	Conversion from SI units
Density	kg/m ³			
Linear density	kg/m			
Momentum	kg · m/s			
Moment of momentum, Angular momentum	} kg · m ² /s			
Moment of inertia		kg · m ²		
Force	N [newton(s)]	dyn [dyne(s)] kgf [kilogram-force] gf [gram-force] tf [ton-force] lbf [pound-force]	1 dyn = 10 ⁻⁵ N 1 kgf = 9.806 65 N 1 gf = 9.806 65 × 10 ⁻³ N 1 tf = 9.806 65 × 10 ³ N 1 lbf = 4.448 22 N	1 N = 10 ⁵ dyn 1 N = 0.101 97 kgf 1 N = 0.224 809 lbf
Moment of force	N · m [newton meter(s)]	gf · cm kgf · cm kgf · m tf · m lbf · ft	1 gf · cm = 9.806 65 × 10 ⁻⁵ N · m 1 kgf · cm = 9.806 65 × 10 ⁻² N · m 1 kgf · m = 9.806 65 N · m 1 tf · m = 9.806 65 × 10 ³ N · m 1 lbf · ft = 1.355 82 N · m	1 N · m = 0.101 97 kgf · m 1 N · m = 0.737 56 lbf · ft
Pressure, Normal stress	Pa [pascal(s)] or N/m ² {1 Pa = 1 N/m ² }	gf/cm ² kgf/mm ² kgf/m ² lbf/in ² bar [bar(s)] at [engineering air pressure] mH ₂ O, mAq [meter water column] atm [atmosphere] mHg [meter mercury column] Torr [torr]	1 gf/cm ² = 9.806 65 × 10 Pa 1 kgf/mm ² = 9.806 65 × 10 ⁶ Pa 1 kgf/m ² = 9.806 65 Pa 1 lbf/in ² = 6 894.76 Pa 1 bar = 10 ⁵ Pa 1 at = 1kgf/cm ² = 9.806 65 × 10 ⁴ Pa 1 mH ₂ O = 9.806 65 × 10 ³ Pa 1 atm = 101 325 Pa 1 mHg = $\frac{101\ 325}{0.76}$ Pa 1 Torr = 1mmHg = 133.322 Pa	1 MPa = 0.101 97 kgf/mm ² 1 Pa = 0.101 97 kgf/m ² 1 Pa = 0.145 × 10 ⁻³ lbf/in ² 1 Pa = 10 ⁻² mbar 1 Pa = 7.500 6 × 10 ⁻³ Torr
Viscosity	Pa · s [pascal second]	P [poise] kgf · s/m ²	10 ⁻² P = 1 cP = 1 mPa · s 1 kgf · s/m ² = 9.806 65 Pa · s	1 Pa · s = 0.101 97 kgf · s/m ²
Kinematic viscosity	m ² /s	St [stokes]	10 ⁻² St = 1 cSt = 1 mm ² /s	
Surface tension	N/m			

SI units and conversion factors (3)

Mass	SI units	Other Units ¹⁾	Conversion into SI units	Conversion from SI units
Work, energy	J [joule(s)] {1 J = 1 N·m}	eV [electron volt(s)] * erg [erg(s)] kgf·m lbf·ft	1 eV = (1.602 189 2±0.000 004 6)×10 ⁻¹⁹ J 1 erg = 10 ⁻⁷ J 1 kgf·m = 9.806 65 J 1 lbf·ft = 1.355 82 J	1 J = 10 ⁷ erg 1 J = 0.101 97 kgf·m 1 J = 0.737 56 lbf·ft
Power	W [watt(s)]	erg/s [ergs per second] kgf·m/s PS [French horse-power] HP [horse-power (British)] lbf·ft/s	1 erg/s = 10 ⁻⁷ W 1 kgf·m/s = 9.806 65 W 1 PS = 75 kgf·m/s = 735.5 W 1 HP = 550 lbf·ft/s = 745.7 W 1 lbf·ft/s = 1.355 82 W	1 W = 0.101 97 kgf·m/s 1 W = 0.001 36 PS 1 W = 0.001 34 HP
Thermo-dynamic temperature	K [kelvin(s)]			
Celsius temperature	°C [celsius(s)] {t°C = (t+273.15) K}	°F [degree(s) Fahrenheit]	t°F = $\frac{5}{9}(t - 32)°C$	t°C = $(\frac{9}{5}t + 32)°F$
Linear expansion coefficient	K ⁻¹	°C ⁻¹ [per degree]		
Heat	J [joule(s)] {1 J = 1 N·m}	erg [erg(s)] kgf·m cal _{IT} [I. T. calories]	1 erg = 10 ⁻⁷ J 1 cal _{IT} = 4.186 8 J 1 Mcal _{IT} = 1.163 kW·h	1 J = 10 ⁷ erg 1 J = 0.238 85 cal _{IT} 1 kW·h = 0.86 × 10 ⁶ cal _{IT}
Thermal conductivity	W/(m·K)	W/(m·°C) cal/(s·m·°C)	1 W/(m·°C) = 1 W/(m·K) 1 cal/(s·m·°C) = 4.186 05 W/(m·K)	
Coefficient of heat transfer	W/(m ² ·K)	W/(m ² ·°C) cal/(s·m ² ·°C)	1 W/(m ² ·°C) = 1 W/(m ² ·K) 1 cal/(s·m ² ·°C) = 4.186 05 W/(m ² ·K)	
Heat capacity	J/K	J/°C	1 J/°C = 1 J/K	
Massic heat capacity	J/(kg·K)	J/(kg·°C)		

Note 1) * : Unit can be used as an SI unit.
No asterisk : Unit cannot be used.

SI units and conversion factors (4)

Mass	SI units	Other Units ¹⁾	Conversion into SI units	Conversion from SI units
Electric current	A [ampere(s)]			
Electric charge, quantity of electricity	C [coulomb(s)] {1 C = 1 A · s}	A · h *	1 A · h = 3.6 kC	
Tension, electric potential	V [volt(s)] {1 V = 1 W/A}			
Capacitance	F [farad(s)] {1 F = 1 C/V}			
Magnetic field strength	A/m	Oe [oersted(s)]	$1 \text{ Oe} = \frac{10^3}{4\pi} \text{ A/m}$	$1 \text{ A/m} = 4\pi \times 10^{-3} \text{ Oe}$
Magnetic flux density	T [tesla(s)] { $1 \text{ T} = 1 \text{ N}/(\text{A} \cdot \text{m})$ $= 1 \text{ Wb}/\text{m}^2$ $= 1 \text{ V} \cdot \text{s}/\text{m}^2$ }	Gs [gauss(es)] γ [gamma(s)]	$1 \text{ Gs} = 10^{-4} \text{ T}$ $1 \gamma = 10^{-9} \text{ T}$	$1 \text{ T} = 10^4 \text{ Gs}$ $1 \text{ T} = 10^9 \gamma$
Magnetic flux	Wb [weber(s)] {1 Wb = 1 V · s}	Mx [maxwell(s)]	$1 \text{ Mx} = 10^{-8} \text{ Wb}$	$1 \text{ Wb} = 10^8 \text{ Mx}$
Self inductance	H [henry (– ries)] {1 H = 1 Wb/A}			
Resistance (to direct current)	Ω [ohm(s)] {1 Ω = 1 V/A}			
Conductance (to direct current)	S [siemens] {1 S = 1 A/V}			
Active power	W { $1 \text{ W} = 1 \text{ J/s}$ $= 1 \text{ A} \cdot \text{V}$ }			

4.3 Shaft tolerance

unit μm

Nominal shaft diameter mm		Deviation classes of shaft diameter																									Nominal shaft diameter mm									
over	up to	d6	e6	e7	e8	e9	f6	f7	f8	g5	g6	h5	h6	h7	h8	h9	h10	js5	js6	js7	j5	j6	k5	k6	k7	m5	m6	m7	n5	n6	p6	r6	r7	over	up to	
-	3	-20	-14	-14	-14	-14	-6	-6	-6	-2	-2	0	0	0	0	0	0	± 2	± 3	± 5	± 2	+4	+4	+6	+10	+6	+8	+12	+8	+10	+10	+16	+20	-	3	
		-26	-20	-24	-28	-39	-12	-16	-20	-6	-8	-4	-6	-10	-14	-25	-40					-2	0	0	0	+2	+2	+2	+4	+4	+6	+10	+10			
3	6	-30	-20	-20	-20	-20	-10	-10	-10	-4	-4	0	0	0	0	0	0	± 2.5	± 4	± 6	+3	+6	+6	+9	+13	+9	+12	+16	+13	+16	+20	+23	+27	3	6	
		-38	-28	-32	-38	-50	-18	-22	-28	-9	-12	-5	-8	-12	-18	-30	-48					-2	+1	+1	+1	+4	+4	+4	+8	+8	+12	+15	+15			
6	10	-40	-25	-25	-25	-25	-13	-13	-13	-5	-5	0	0	0	0	0	0	± 3	± 4.5	± 7.5	+4	+7	+7	+10	+16	+12	+15	+21	+16	+19	+24	+28	+34	6	10	
		-49	-34	-40	-47	-61	-22	-28	-35	-11	-14	-6	-9	-15	-22	-36	-58					-2	+1	+1	+1	+6	+6	+6	+10	+10	+15	+19	+19			
10	18	-50	-32	-32	-32	-32	-16	-16	-16	-6	-6	0	0	0	0	0	0	± 4	± 5.5	± 9	+5	+8	+9	+12	+19	+15	+18	+25	+20	+23	+29	+34	+41	10	18	
		-61	-43	-50	-59	-75	-27	-34	-43	-14	-17	-8	-11	-18	-27	-43	-70					-3	+1	+1	+1	+7	+7	+7	+12	+12	+18	+23	+23			
18	30	-65	-40	-40	-40	-40	-20	-20	-20	-7	-7	0	0	0	0	0	0	± 4.5	± 6.5	± 10.5	+5	+9	+11	+15	+23	+17	+21	+29	+24	+28	+35	+41	+49	18	30	
		-78	-53	-61	-73	-92	-33	-41	-53	-16	-20	-9	-13	-21	-33	-52	-84					-4	+2	+2	+2	+8	+8	+8	+15	+15	+22	+28	+28			
30	50	-80	-50	-50	-50	-50	-25	-25	-25	-9	-9	0	0	0	0	0	0	± 5.5	± 8	± 12.5	+6	+11	+13	+18	+27	+20	+25	+34	+28	+33	+42	+50	+59	30	50	
		-96	-66	-75	-89	-112	-41	-50	-64	-20	-25	-11	-16	-25	-39	-62	-100					-5	+2	+2	+2	+9	+9	+9	+17	+17	+26	+34	+34			
50	80	-100	-60	-60	-60	-60	-30	-30	-30	-10	-10	0	0	0	0	0	0	± 6.5	± 9.5	± 15	+6	+12	+15	+21	+32	+24	+30	+41	+33	+39	+51	+60	+71	50	65	
		-119	-79	-90	-106	-134	-49	-60	-76	-23	-29	-13	-19	-30	-46	-74	-120					-7	-7	+2	+2	+2	+11	+11	+11	+20	+20	+32	+41	+41	65	80
80	120	-120	-72	-72	-72	-72	-36	-36	-36	-12	-12	0	0	0	0	0	0	± 7.5	± 11	± 17.5	+6	+13	+18	+25	+38	+28	+35	+48	+38	+45	+59	+62	+73	80	100	
		-142	-94	-107	-126	-159	-58	-71	-90	-27	-34	-15	-22	-35	-54	-87	-140					-9	-9	+3	+3	+3	+13	+13	+13	+23	+23	+37	+43	+43	100	120
120	180	-145	-85	-85	-85	-85	-43	-43	-43	-14	-14	0	0	0	0	0	0	± 9	± 12.5	± 20	+7	+14	+21	+28	+43	+33	+40	+55	+45	+52	+68	+88	+103	120	140	
		-170	-110	-125	-148	-185	-68	-83	-106	-32	-39	-18	-25	-40	-63	-100	-160					-11	-11	+3	+3	+3	+15	+15	+15	+27	+27	+43	+63	+63	140	160
180	250	-170	-100	-100	-100	-100	-50	-50	-50	-15	-15	0	0	0	0	0	0	± 10	± 14.5	± 23	+7	+16	+24	+33	+50	+37	+46	+63	+51	+60	+79	+106	+123	180	200	
		-199	-129	-146	-172	-215	-79	-96	-122	-35	-44	-20	-29	-46	-72	-115	-185					-13	-13	+4	+4	+4	+17	+17	+17	+31	+31	+50	+77	+77	200	225
250	315	-190	-110	-110	-110	-110	-56	-56	-56	-17	-17	0	0	0	0	0	0	± 11.5	± 16	± 26	+7	± 16	+27	+36	+56	+43	+52	+72	+57	+66	+88	+126	+146	250	280	
		-222	-142	-162	-191	-240	-88	-108	-137	-40	-49	-23	-32	-52	-81	-130	-210					-16	± 16	+4	+4	+4	+20	+20	+20	+34	+34	+56	+84	+84	280	315
315	400	-210	-125	-125	-125	-125	-62	-62	-62	-18	-18	0	0	0	0	0	0	± 12.5	± 18	± 28.5	+7	± 18	+29	+40	+61	+46	+57	+78	+62	+73	+98	+144	+165	315	355	
		-246	-161	-182	-214	-265	-98	-119	-151	-43	-54	-25	-36	-57	-89	-140	-230					-18	± 18	+4	+4	+4	+21	+21	+21	+37	+37	+62	+108	+108	355	400
400	500	-230	-135	-135	-135	-135	-68	-68	-68	-20	-20	0	0	0	0	0	0	± 13.5	± 20	± 31.5	+7	± 20	+32	+45	+68	+50	+63	+86	+67	+80	+108	+166	+189	400	450	
		-270	-175	-198	-232	-290	-108	-131	-165	-47	-60	-27	-40	-63	-97	-155	-250					-20	± 20	+5	+5	+5	+23	+23	+23	+40	+40	+68	+126	+126	450	500
500	630	-260	-145	-145	-145	-145	-76	-76	-76	-22	-22	0	0	0	0	0	0	± 16	± 22	± 35	-	-	+32	+44	+70	+58	+70	+96	+76	+88	+122	+194	+220	500	560	
		-304	-189	-215	-255	-320	-120	-146	-186	-54	-66	-32	-44	-70	-110	-175	-280					0	0	0	+26	+26	+26	+44	+44	+78	+150	+150	+199	+225	560	630
630	800	-290	-160	-160	-160	-160	-80	-80	-80	-24	-24	0	0	0	0	0	0	± 18	± 25	± 40	-	-	+36	+50	+80	+66	+80	+110	+86	+100	+138	+225	+255	630	710	
		-340	-210	-240	-285	-360	-130	-160	-205	-60	-74	-36	-50	-80	-125	-200	-320					0	0	0	+30	+30	+30	+50	+50	+88	+175	+175	+235	+265	710	800
800	1 000	-320	-170	-170	-170	-170	-86	-86	-86	-26	-26	0	0	0	0	0	0	± 20	± 28	± 45	-	-	+40	+56	+90	+74	+90	+124	+96	+112	+156	+266	+300	800	900	
		-376	-226	-260	-310	-400	-142	-176	-226	-66	-82	-40	-56	-90	-140	-230	-360					0	0	0	+34	+34	+34	+56	+56	+100	+210	+210	+276	+310	900	1 000

4.4 Housing bore tolerance

unit μm

Nominal bore diameter mm		Deviation classes of housing bore diameter																				Nominal bore diameter mm								
over	up to	E6	F6	F7	G6	G7	H6	H7	H8	H9	H10	JS5	JS6	JS7	J6	J7	K5	K6	K7	M5	M6	M7	N5	N6	N7	P6	P7	R7	over	up to
3	6	+28 +20	+18 +10	+22 +10	+12 +4	+16 +4	+8 0	+12 0	+18 0	+30 0	+48 0	±2.5	±4	±6	+5 -3	±6	0 -5	+2 -6	+3 -9	-3 -8	-1 -9	0 -12	-7 -12	-5 -13	-4 -16	-9 -17	-8 -20	-11 -23	3	6
6	10	+34 +25	+22 +13	+28 +13	+14 +5	+20 +5	+9 0	+15 0	+22 0	+36 0	+58 0	±3	±4.5	±7.5	+5 -4	+8 -7	+1 -5	+2 -7	+5 -10	-4 -10	-3 -12	0 -15	-8 -14	-7 -16	-4 -19	-12 -21	-9 -24	-13 -28	6	10
10	18	+43 +32	+27 +16	+34 +16	+17 +6	+24 +6	+11 0	+18 0	+27 0	+43 0	+70 0	±4	±5.5	±9	+6 -5	+10 -8	+2 -6	+2 -9	+6 -12	-4 -12	-4 -15	0 -18	-9 -17	-9 -20	-5 -23	-15 -26	-11 -29	-16 -34	10	18
18	30	+53 +40	+33 +20	+41 +20	+20 +7	+28 +7	+13 0	+21 0	+33 0	+52 0	+84 0	±4.5	±6.5	±10.5	+8 -5	+12 -9	+1 -8	+2 -11	+6 -15	-5 -14	-4 -17	0 -21	-12 -21	-11 -24	-7 -28	-18 -31	-14 -35	-20 -41	18	30
30	50	+66 +50	+41 +25	+50 +25	+25 +9	+34 +9	+16 0	+25 0	+39 0	+62 0	+100 0	±5.5	±8	±12.5	+10 -6	+14 -11	+2 -9	+3 -13	+7 -18	-5 -16	-4 -20	0 -25	-13 -24	-12 -28	-8 -33	-21 -37	-17 -42	-25 -50	30	50
50	80	+79 +60	+49 +30	+60 +30	+29 +10	+40 +10	+19 0	+30 0	+46 0	+74 0	+120 0	±6.5	±9.5	±15	+13 -6	+18 -12	+3 -10	+4 -15	+9 -21	-6 -19	-5 -24	0 -30	-15 -28	-14 -33	-9 -39	-26 -45	-21 -51	-30 -62	50	80
80	120	+94 +72	+58 +36	+71 +36	+34 +12	+47 +12	+22 0	+35 0	+54 0	+87 0	+140 0	±7.5	±11	±17.5	+16 -6	+22 -13	+2 -13	+4 -18	+10 -25	-8 -23	-6 -28	0 -35	-18 -33	-16 -38	-10 -45	-30 -52	-24 -59	-38 -76	80	120
120	180	+110 +85	+68 +43	+83 +43	+39 +14	+54 +14	+25 0	+40 0	+63 0	+100 0	+160 0	±9	±12.5	±20	+18 -7	+26 -14	+3 -15	+4 -21	+12 -28	-9 -27	-8 -33	0 -40	-21 -39	-20 -45	-12 -52	-36 -61	-28 -68	-48 -90	120	180
180	250	+129 +100	+79 +50	+96 +50	+44 +15	+61 +15	+29 0	+46 0	+72 0	+115 0	+185 0	±10	±14.5	±23	+22 -7	+30 -16	+2 -18	+5 -24	+13 -33	-11 -31	-8 -37	0 -46	-25 -45	-22 -51	-14 -60	-41 -70	-33 -79	-60 -109	180	250
250	315	+142 +110	+88 +56	+108 +56	+49 +17	+69 +17	+32 0	+52 0	+81 0	+130 0	+210 0	±11.5	±16	±26	+25 -7	+36 -16	+3 -20	+5 -27	+16 -36	-13 -36	-9 -41	0 -52	-27 -50	-25 -57	-14 -66	-47 -79	-36 -88	-74 -130	250	315
315	400	+161 +125	+98 +62	+119 +62	+54 +18	+75 +18	+36 0	+57 0	+89 0	+140 0	+230 0	±12.5	±18	±28.5	+29 -7	+39 -18	+3 -22	+7 -29	+17 -40	-14 -39	-10 -46	0 -57	-30 -55	-26 -62	-16 -73	-51 -87	-41 -98	-87 -144	315	400
400	500	+175 +135	+108 +68	+131 +68	+60 +20	+83 +20	+40 0	+63 0	+97 0	+155 0	+250 0	±13.5	±20	±31.5	+33 -7	+43 -20	+2 -25	+8 -32	+18 -45	-16 -43	-10 -50	0 -63	-33 -60	-27 -67	-17 -80	-55 -95	-45 -108	-103 -172	400	500
500	630	+189 +145	+120 +76	+146 +76	+66 +22	+92 +22	+44 0	+70 0	+110 0	+175 0	+280 0	±16	±22	±35	-	-	0 -32	0 -44	0 -70	-26 -58	-26 -70	-26 -96	-44 -76	-44 -88	-44 -114	-78 -122	-78 -148	-150 -225	500	630
630	800	+210 +160	+130 +80	+160 +80	+74 +24	+104 +24	+50 0	+80 0	+125 0	+200 0	+320 0	±18	±25	±40	-	-	0 -36	0 -50	0 -80	-30 -66	-30 -80	-30 -110	-50 -86	-50 -100	-50 -130	-88 -138	-88 -168	-175 -265	630	800
800	1 000	+226 +170	+142 +86	+176 +86	+82 +26	+116 +26	+56 0	+90 0	+140 0	+230 0	+360 0	±20	±28	±45	-	-	0 -40	0 -56	0 -90	-34 -74	-34 -90	-34 -124	-56 -96	-56 -112	-56 -146	-100 -156	-100 -190	-210 -310	800	1 000
1 000	1 250	+261 +195	+164 +98	+203 +98	+94 +28	+133 +28	+66 0	+105 0	+165 0	+260 0	+420 0	±23.5	±33	±52.5	-	-	0 -47	0 -66	0 -105	-40 -87	-40 -106	-40 -145	-66 -113	-66 -132	-66 -171	-120 -186	-120 -225	-250 -365	1 000	1 250

4.5 °C - °F temperature conversion table

4.5 °C - °F temperature conversion table

°C		°F	°C		°F	°C		°F	°C		°F
- 73	- 100	- 148	- 1.6	29	84.2	17.7	64	147.2	37.1	99	210.2
- 62	- 80	- 112	- 1.1	30	86.0	18.2	65	149.0	37.7	100	212
- 51	- 60	- 76	- 0.6	31	87.8	18.8	66	150.8	40.6	105	221
- 40	- 40	- 40	0	32	89.6	19.3	67	152.6	43	110	230
- 29	- 20	- 4	0.5	33	91.4	19.9	68	154.4	49	120	248
- 23.3	- 10	14	1.1	34	93.2	20.4	69	156.2	54	130	266
- 17.7	0	32	1.6	35	95.0	21.0	70	158.0	60	140	284
- 17.2	1	33.8	2.2	36	96.8	21.5	71	159.8	65	150	302
- 16.6	2	35.6	2.7	37	98.6	22.2	72	161.6	71	160	320
- 16.1	3	37.4	3.3	38	100.4	22.7	73	163.4	76	170	338
- 15.5	4	39.2	3.8	39	102.2	23.3	74	165.2	83	180	356
- 15.0	5	41.0	4.4	40	104.0	23.8	75	167.0	88	190	374
- 14.4	6	42.8	4.9	41	105.8	24.4	76	168.8	93	200	392
- 13.9	7	44.6	5.4	42	107.6	25.0	77	170.6	121	250	482
- 13.3	8	46.4	6.0	43	109.4	25.5	78	172.4	149	300	572
- 12.7	9	48.2	6.6	44	111.2	26.2	79	174.2	177	350	662
- 12.2	10	50.0	7.1	45	113.0	26.8	80	176.0	204	400	752
- 11.6	11	51.8	7.7	46	114.8	27.3	81	177.8	232	450	842
- 11.1	12	53.6	8.2	47	116.6	27.7	82	179.6	260	500	932
- 10.5	13	55.4	8.8	48	118.4	28.2	83	181.4	288	550	1 022
- 10.0	14	57.2	9.3	49	120.2	28.8	84	183.2	315	600	1 112
- 9.4	15	59.0	9.9	50	122.0	29.3	85	185.0	343	650	1 202
- 8.8	16	61.8	10.4	51	123.8	29.9	86	186.8	371	700	1 292
- 8.3	17	63.6	11.1	52	125.6	30.4	87	188.6	399	750	1 382
- 7.7	18	65.4	11.5	53	127.4	31.0	88	190.4	426	800	1 472
- 7.2	19	67.2	12.1	54	129.2	31.5	89	192.2	454	850	1 562
- 6.6	20	68.0	12.6	55	131.0	32.1	90	194.0	482	900	1 652
- 6.1	21	69.8	13.2	56	132.8	32.6	91	195.8	510	950	1 742
- 5.5	22	71.6	13.7	57	134.6	33.3	92	197.6	538	1 000	1 832
- 5.0	23	73.4	14.3	58	136.4	33.8	93	199.4	593	1 100	2 012
- 4.4	24	75.2	14.8	59	138.2	34.4	94	201.2	648	1 200	2 192
- 3.9	25	77.0	15.6	60	140.0	34.9	95	203.0	704	1 300	2 372
- 3.3	26	78.8	16.1	61	141.8	35.5	96	204.8	760	1 400	2 552
- 2.8	27	80.6	16.6	62	143.6	36.1	97	206.6	815	1 500	2 732
- 2.2	28	82.4	17.1	63	145.4	36.6	98	208.4	871	1 600	2 937

Example

The center columns of numbers is the temperature in either degrees Centigrade (°C) or Fahrenheit (°F) whichever is desired to convert into the other.
If degrees Fahrenheit is given, read degrees Centigrade to the left. If degrees Centigrade is given, read degrees Fahrenheit to the right.

$$C = \frac{5}{9}(F - 32)$$

$$F = \frac{9}{5}C + 32$$

4.6 Steel hardness conversion table

Rockwell C-scale 1471.0 N {150 kgf}	Vicker's	Brinell		Rockwell		Shore
		Standard ball	Tungsten carbide ball	A-scale 588.4 N {60 kgf}	B-scale 980.7 N {100 kgf}	
68	940			85.6		97
67	900			85.0		95
66	865			84.5		92
65	832		739	83.9		91
64	800		722	83.4		88
63	772		705	82.8		87
62	746		688	82.3		85
61	720		670	81.8		83
60	697		654	81.2		81
59	674		634	80.7		80
58	653		615	80.1		78
57	633		595	79.6		76
56	613		577	79.0		75
55	595	–	560	78.5		74
54	577	–	543	78.0		72
53	560	–	525	77.4		71
52	544	500	512	76.8		69
51	528	487	496	76.3		68
50	513	475	481	75.9		67
49	498	464	469	75.2		66
48	484	451	455	74.7		64
47	471	442	443	74.1		63
46	458	432	432	73.6		62
45	446		421	73.1		60
44	434		409	72.5		58
43	423		400	72.0		57
42	412		390	71.5		56
41	402		381	70.9		55
40	392		371	70.4	–	54
39	382		362	69.9	–	52
38	372		353	69.4	–	51
37	363		344	68.9	–	50
36	354		336	68.4	(109.0)	49
35	345		327	67.9	(108.5)	48
34	336		319	67.4	(108.0)	47
33	327		311	66.8	(107.5)	46
32	318		301	66.3	(107.0)	44
31	310		294	65.8	(106.0)	43
30	302		286	65.3	(105.5)	42
29	294		279	64.7	(104.5)	41
28	286		271	64.3	(104.0)	41
27	279		264	63.8	(103.0)	40
26	272		258	63.3	(102.5)	38
25	266		253	62.8	(101.5)	38
24	260		247	62.4	(101.0)	37
23	254		243	62.0	100.0	36
22	248		237	61.5	99.0	35
21	243		231	61.0	98.5	35
20	238		226	60.5	97.8	34
(18)	230		219	–	96.7	33
(16)	222		212	–	95.5	32
(14)	213		203	–	93.9	31
(12)	204		194	–	92.3	29
(10)	196		187		90.7	28
(8)	188		179		89.5	27
(6)	180		171		87.1	26
(4)	173		165		85.5	25
(2)	166		158		83.5	24
(0)	160		152		81.7	24

4.7 Viscosity conversion table

4.7 Viscosity conversion table

Kinematic viscosity mm ² /s	Saybolt SUS (second)		Redwood R (second)		Engler E (degree)
	100 °F	210 °F	50 °C	100 °C	
2	32.6	32.8	30.8	31.2	1.14
3	36.0	36.3	33.3	33.7	1.22
4	39.1	39.4	35.9	36.5	1.31
5	42.3	42.6	38.5	39.1	1.40
6	45.5	45.8	41.1	41.7	1.48
7	48.7	49.0	43.7	44.3	1.56
8	52.0	52.4	46.3	47.0	1.65
9	55.4	55.8	49.1	50.0	1.75
10	58.8	59.2	52.1	52.9	1.84
11	62.3	62.7	55.1	56.0	1.93
12	65.9	66.4	58.2	59.1	2.02
13	69.6	70.1	61.4	62.3	2.12
14	73.4	73.9	64.7	65.6	2.22
15	77.2	77.7	68.0	69.1	2.32
16	81.1	81.7	71.5	72.6	2.43
17	85.1	85.7	75.0	76.1	2.54
18	89.2	89.8	78.6	79.7	2.64
19	93.3	94.0	82.1	83.6	2.76
20	97.5	98.2	85.8	87.4	2.87
21	102	102	89.5	91.3	2.98
22	106	107	93.3	95.1	3.10
23	110	111	97.1	98.9	3.22
24	115	115	101	103	3.34
25	119	120	105	107	3.46
26	123	124	109	111	3.58
27	128	129	112	115	3.70
28	132	133	116	119	3.82
29	137	138	120	123	3.95
30	141	142	124	127	4.07
31	145	146	128	131	4.20
32	150	150	132	135	4.32
33	154	155	136	139	4.45
34	159	160	140	143	4.57

Kinematic viscosity mm ² /s	Saybolt SUS (second)		Redwood R (second)		Engler E (degree)
	100 °F	210 °F	50 °C	100 °C	
35	163	164	144	147	4.70
36	168	170	148	151	4.83
37	172	173	153	155	4.96
38	177	178	156	159	5.08
39	181	183	160	164	5.21
40	186	187	164	168	5.34
41	190	192	168	172	5.47
42	195	196	172	176	5.59
43	199	201	176	180	5.72
44	204	205	180	185	5.85
45	208	210	184	189	5.98
46	213	215	188	193	6.11
47	218	219	193	197	6.24
48	222	224	197	202	6.37
49	227	228	201	206	6.50
50	231	233	205	210	6.63
55	254	256	225	231	7.24
60	277	279	245	252	7.90
65	300	302	266	273	8.55
70	323	326	286	294	9.21
75	346	349	306	315	9.89
80	371	373	326	336	10.5
85	394	397	347	357	11.2
90	417	420	367	378	11.8
95	440	443	387	399	12.5
100	464	467	408	420	13.2
120	556	560	490	504	15.8
140	649	653	571	588	18.4
160	742	747	653	672	21.1
180	834	840	734	757	23.7
200	927	933	816	841	26.3
250	1 159	1 167	1 020	1 051	32.9
300	1 391	1 400	1 224	1 241	39.5

Remark) 1 mm²/s=1 cSt (centi stokes)

4.8 Shaft surface speed – Quick reference diagram –

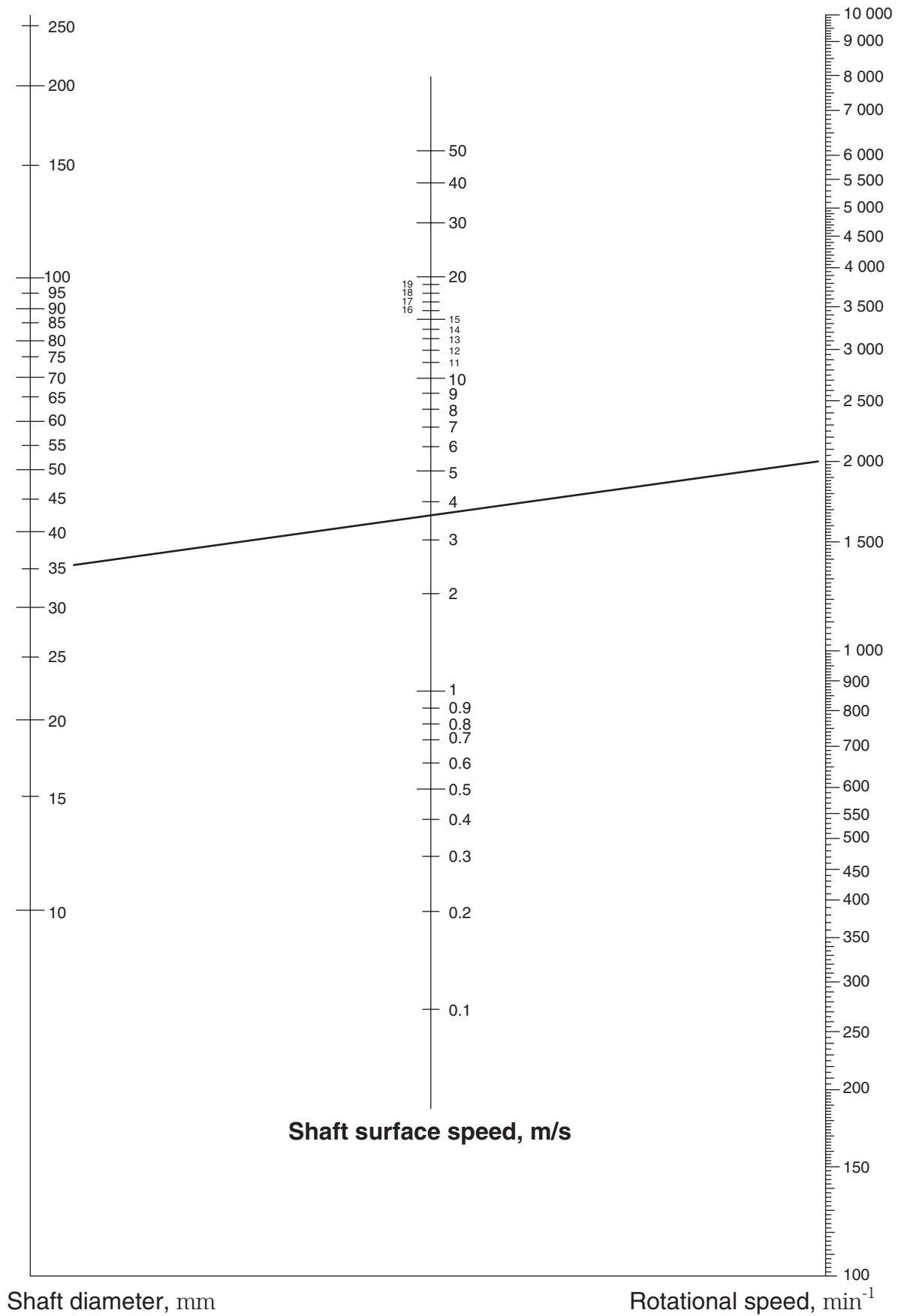

5. Request Forms for Oil Seal Design and Production

5. Request Forms for Oil Seal Design and Production

Fill in the Request Forms for Oil Seal Design and Production (1) and (2) and send them by fax to your

nearest JTEKT office when you need oil seal selection or when you have any requests or questions.

Request Form for Oil Seal Design and Production (1)

Your name		TEL	
Company / Dept.		FAX	
Address			

Applied position		Machine name							
Shaft	Outside diameter and tolerance	Housing	Bore diameter and tolerance						
	Chamfer		L_1	θ_1	Width and tolerance				
	Motion type		Rotary / Reciprocating / Oscillatory		Chamfer	L_2	θ_2		
	Direction of motion		Horizontal / Vertical		Material and surface roughness				
		Other ()		Housing bore eccentricity	mm TIR				
	Motion frequency	Continuous		Sealed medium	Substance to be sealed	Inside			
		Intermittent				Outside			
		Other (rapid acceleration / deceleration)		Level					
	Rotational speed	Normal:	Max.:	min^{-1}	Temperature	Normal	$^{\circ}\text{C}$ Max.	$^{\circ}\text{C}$	
	Sliding frequency		Hz	mm	Pressure	Internal	Normal	kPa Max.	kPa
	Oscillation frequency		Hz	$^{\circ}$		External	Normal	kPa Max.	kPa
	Shaft runout			mm TIR	Bearing	Bearing Number			
	Material and hardness					Lubricant oil name			
	Surface finishing method					Lubrication method			
Surface roughness				Oil bath / Circulation / Splash / Drip / Other ()					

Mounting specification

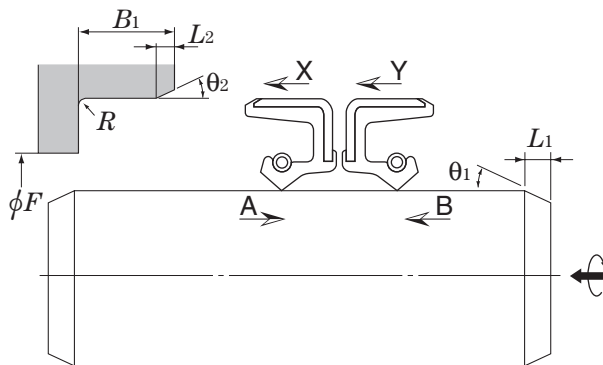

- Housing shoulder diameter F :
 - Housing bore depth B_1 :
 - Housing bore radius R :
 - Seal mounting direction into housing: X/Y
 - Seal mounting direction onto shaft: A/B
 - Shaft rotational direction: Right/Left/Bi-direction
- Right: Clockwise when viewed from oil seal back face
 Left: Counterclockwise when viewed from oil seal back face

☆ Please specify as many items as possible to enable correct product design and selection.

Request Form for Oil Seal Design and Production (2)

Shaft diameter	Changeable	Yes/No	To ϕ ____ mm (max. min.)	Oil seal type	Your requested type	Yes () / No
Housing bore diameter	Changeable	Yes/No	To ϕ ____ mm (max. min.)	Rubber material	Your requested type	Yes () / No
Width	Changeable	Yes/No	To ____ mm (max. min.)	Other		
Requested oil seal life						
<u>Mounting location details</u> (Attach drawing of the oil seal location, if possible). <div style="height: 300px; border: 1px solid black;"></div>						
<u>Requests/Questions</u> <div style="height: 150px; border: 1px solid black;"></div>						

☆ Please specify as many items as possible to enable correct product design and selection.

<Manufacture>**KOYO SEALING TECHNO CO., LTD.****HEAD OFFICE / PLANT**

No.39, Aza-nishino, Kasagi, Aizumi-cho, Itano-gun, Tokushima 771-1295, JAPAN
 TEL : 81-88-692-2711 FAX : 81-88-692-8096

<Sales>**JTEKT CORPORATION****NAGOYA HEAD OFFICE**

No.7-1, Meieki 4-chome, Nakamura-ku, Nagoya, Aichi
 450-8515, JAPAN
 TEL : 81-52-527-1900 FAX : 81-52-527-1911

OSAKA HEAD OFFICE

No.5-8, Minamisemba 3-chome, Chuo-ku, Osaka
 542-8502, JAPAN
 TEL : 81-6-6271-8451 FAX : 81-6-6245-3712

Sales & Marketing Headquarters

TEL : 81-6-6245-6087 FAX : 81-6-6244-9007

(America)**KOYO CANADA INC.**

5324 South Service Road, Burlington, Ontario L7L 5H5, CANADA
 TEL : 1-905-681-1121
 FAX : 1-905-681-1392

KOYO CORPORATION OF U.S.A.**-Cleveland Office-**

29570 Clemens Road, P.O.Box 45028 Westlake,
 OH 44145, U.S.A.
 TEL : 1-440-835-1000
 FAX : 1-440-835-9347

-Detroit Office-

47771 Halyard Drive, Plymouth, MI 48170, U.S.A.
 TEL : 1-734-454-1500
 FAX : 1-734-454-4076

KOYO MEXICANA, S.A. DE C.V.

Rio Nazas No.171, 3er piso, Col. Cuauhtemoc, México,
 D.F. C.P. 06500, MÉXICO
 TEL : 52-55-5207-3860
 FAX : 52-55-5207-3873

KOYO LATIN AMERICA, S.A.

Edificio Banco del Pacifico Planta Baja, Calle Aquilino de la
 Guardia y Calle 52, Panama, REPUBLICA DE PANAMA
 TEL : 507-208-5900
 FAX : 507-264-2782/507-269-7578

KOYO ROLAMENTOS DO BRASIL LTDA.

Rua Desembargador Eliseu Ghilherme 304, 7-Andar, Paraiso,
 CEP 04004-30, BRASIL
 TEL : 55-11-3887-9173
 FAX : 55-11-3887-3039

(Asia Oceania)**JTEKT (THAILAND) Co., LTD.**

172/1 Moo 12 Tambol Bangwua, Amphur Bangpakong,
 Chachoengsao 24180, THAILAND
 TEL : 66-38-533-310-7
 FAX : 66-38-532-776

PT. JTEKT INDONESIA

MM2100 Industrial Town Block DD-3, Cikarang Barat,
 Bekasi 17520, INDONESIA
 TEL : 62-21-8998-3273
 FAX : 62-21-8998-3274

KOYO SINGAPORE BEARING (PTE.) LTD.

27, Penjuru Lane, #09-01 C&P Logistics Hub 2, SINGAPORE
 609195
 TEL : 65-6274-2200
 FAX : 65-6862-1623

-MIDDLE EAST (BRANCH)-

6EA312, Dubai Airport Free Zone, P.O. Box 54816, Dubai, U.A.E.
 TEL : 971-4-2993600
 FAX : 971-4-2993700

PHILIPPINE KOYO BEARING CORPORATION

6th Floor One World Square Building, #10 Upper McKinley Road,
 McKinley Town Center, Fort Bonifacio, 1634 Taguig City,
 PHILIPPINES
 TEL : 63-2-856-5046/5047
 FAX : 63-2-856-5045

JTEKT KOREA CO., LTD.

Inwoo Building 6F, 539-11, Shinsa-Dong,
 Kangnam-Ku, Seoul, KOREA
 TEL : 82-2-549-7922
 FAX : 82-2-549-7923

JTEKT (CHINA) CO., LTD.

Rm.1905, Aetna Tower, 107 Zunyi Road, Shanghai, 200051,
 CHINA
 TEL : 86-21-6237-5280
 FAX : 86-21-6237-5277

KOYO (SHANGHAI) CO., LTD.

Rm.1905, Aetna Tower, 107 Zunyi Road, Shanghai, 200051,
 CHINA
 TEL : 86-21-6237-5280
 FAX : 86-21-6237-5277

KOYO AUSTRALIA PTY. LTD.

Unit 2, 8 Hill Road, Homebush Bay, NSW 2127, AUSTRALIA
 TEL : 61-2-8719-5300
 FAX : 61-2-8719-5333

(Europe)**JTEKT EUROPE BEARINGS B.V.**

Markerkant 13-01, 1314 AN Almere, THE NETHERLANDS
 TEL : 31-36-5383333
 FAX : 31-36-5347212

KOYO KULLAGER SCANDINAVIA A.B.

Johanneslundsvägen 4, 194 61 Upplands Väsby, SWEDEN
 TEL : 46-8-594-212-10
 FAX : 46-8-594-212-29

KOYO (U.K.) LTD.

Whitehall Avenue, Kingston, Milton Keynes MK10 OAX,
 UNITED KINGDOM
 TEL : 44-1908-289300
 FAX : 44-1908-289333

KOYO ROMANIA REPRESENTATIVE OFFICE

Str. Frederic Jolliot-Curie, Nr.3, Etaj 1, Ap.2, Sector 5
 Bucharest, ROMANIA
 TEL : 40-21-410-4170/4182/0984
 FAX : 40-21-410-1178

KOYO DEUTSCHLAND GMBH.

Bargkoppelweg 4, D-22145 Hamburg, GERMANY
 TEL : 49-40-67-9090-0
 FAX : 49-40-67-9203-0

KOYO FRANCE S.A.

8 Rue Guy Moquet, B.P.189 Z.I., 95105 Argenteuil Cedex,
 FRANCE
 TEL : 33-1-3998-4202
 FAX : 33-1-3998-4244/4249

KOYO IBERICA, S.L.

Avda.da la Industria, 52-2 izda 28820
 Coslada Madrid, SPAIN
 TEL : 34-91-329-0818
 FAX : 34-91-747-1194

KOYO ITALIA S.R.L.

Via Bronzino 9, 20133 Milano, ITALY
 TEL : 39-02-2951-0844
 FAX : 39-02-2951-0954

Value & Technology



This catalog has been printed on paper of recycled paper pulp using environmentally friendly soy ink.