

NBS®



RUOTE LIBERE **FREE WHEELS**



CATALOGO TECNICO GENERALE
GENERAL TECHNICAL CATALOGUE
1.2.12



NBS[®]

■ SEDE PRINCIPALE
HEAD OFFICE

■ UFFICIO COMMERCIALE
SALES DEPARTMENT

■ MAGAZZINO
WAREHOUSE



ITALCUSCINETTI S.p.A.
forniture industriali
industrial supplies



ITALCUSCINETTI S.p.A. - Via Caponnetto, 15 - 42048 Rubiera (RE) ITALIA
Vendite ITALIA Tel. 0039 0522 621811 - Fax 0039 0522 628926
Export Sales Dept. Tel. 0039 0522 621830 - Fax 0039 0522 626149
Purchasing Dept. Tel. 0039 0522 621880 - Fax 0039 0522 629255
Codice Fiscale e Partita IVA CEE IT 00966080350
R.E.A. C.C.I.A.A. RE 153325 - Capitale Sociale € 1.000.000 i.v.
info@italcuscinetti.it - **www.italcuscinetti.it**

SHANGHAI ITALCUSCINETTI CO., LTD. - No. 89, Lane 85 Qianyun Road
Xujing Town, Qingpu District - Shanghai 201702 (People's Republic of China)
Tel. 0086 21 34313431 - Fax 0086 21 34314431 - **info@italbearings.cn**



CUSCINETTI E COMPONENTI
BEARINGS AND COMPONENTS*



CUSCINETTI PER APPLICAZIONI "BASSA RUMOROSITÀ"
BEARINGS FOR "LOW NOISE" APPLICATIONS*



CUSCINETTI A RULLINI - RUOTE LIBERE
NEEDLE BEARINGS - FREE WHEELS*



COMPONENTI PER LA MOVIMENTAZIONE LINEARE
COMPONENTS FOR LINEAR MOTION*



CUSCINETTI
BEARINGS

DISTRIBUTORE ESCLUSIVISTA PER L'EUROPA - EUROPEAN SOLE AGENT*

Programma generale di vendita

General sales program

ITALY/EU REGISTERED



CUSCINETTI E COMPONENTI *
BEARINGS AND COMPONENTS *

ITALY/EU REGISTERED



SUPPORTI AUTOALLINEANTI *
SELF-ALIGNING BEARING UNITS *

ITALY/EU REGISTERED



SNODI SFERICI - TESTE A SNODO - FORCELLE *
SPHERICAL PLAIN BEARINGS - ROD ENDS - CLEVISES *

ITALY/EU REGISTERED

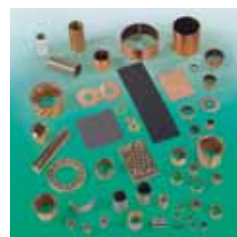

BOCCOLE *
BUSHES *

ITALY/EU REGISTERED



CUSCINETTI DI BASE *
SLEWING BEARINGS *

ITALY/EU REGISTERED



ELECTRICAL MOTORS STANDARD

CUSCINETTI PER APPLICAZIONI "BASSA RUMOROSITÀ" *
BEARINGS FOR "LOW NOISE" APPLICATIONS *

ITALY/EU REGISTERED



CUSCINETTI A RULLINI *
NEEDLE BEARINGS *

ITALY/EU REGISTERED

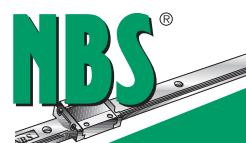

COMPONENTI PER LA MOVIMENTAZIONE LINEARE *
COMPONENTS FOR LINEAR MOTION *

ITALY/EU REGISTERED



RUOTE LIBERE *
FREE WHEELS *

Disponibile grande e completo assortimento di cuscinetti con pronta consegna.

Big and full assortment of bearings with prompt delivery.



CUSCINETTI SKF - FAG
SKF - FAG BEARINGS

* Per ulteriori informazioni, potete richiedere il catalogo tecnico, disponibile anche on line: www.italcuscinetti.it

* For further information, please ask for technical catalogue, also available on line: www.italcuscinetti.it

NBS[®]

CATALOGO TECNICO GENERALE ***GENERAL TECHNICAL CATALOGUE***

Distributore / Distributor

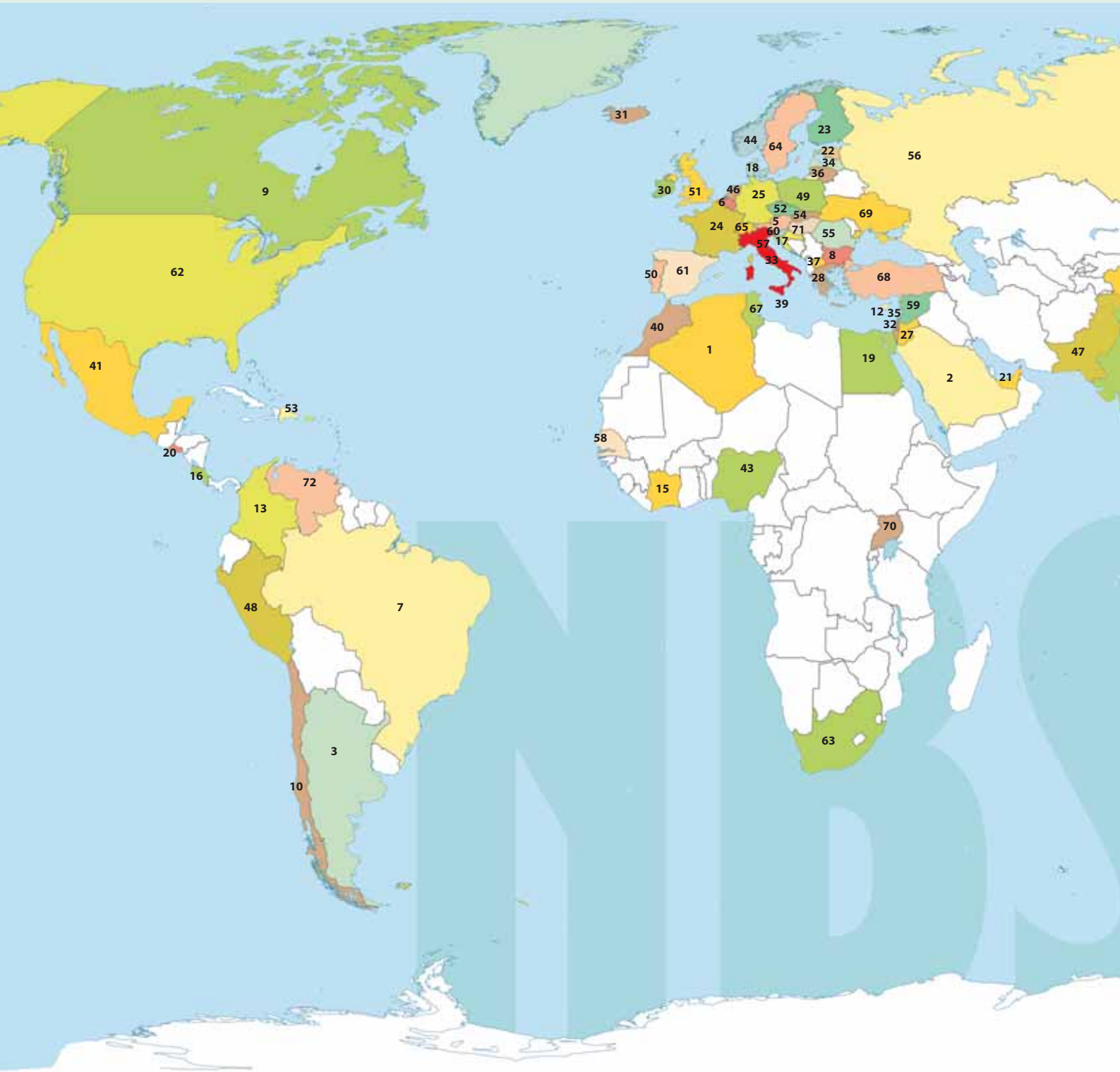

*ora legale (periodo da marzo ad ottobre in Italia)

*summer time (from march to october in Italy)

ora solare (-1)

standard time (-1)

per le capitali con l'orario indicato in rosso non c'è ora legale

time is indicated in red for Capitals without summer time



	1 ALGERIA (Algeri - 11:00)	ALGERIA
	2 ARABIA SAUDITA (Riyadh - 13:00)	SAUDI ARABIA
	3 ARGENTINA (Buenos Aires - 07:00)	ARGENTINA
	4 AUSTRALIA (Canberra - 20:00)	AUSTRALIA
	5 AUSTRIA (Vienna - 12:00)	AUSTRIA
	6 BELGIO (Bruxelles - 12:00)	BELGIUM
	7 BRASILE (Brasilia - 07:00)	BRAZIL
	8 BULGARIA (Sofia - 13:00)	BULGARIA
	9 CANADA (Ottawa - 06:00)	CANADA
	10 CILE (Santiago - 06:00)	CHILE
	11 CINA (Pechino - 18:00)	CHINA
	12 CIPRO (Nicosia - 13:00)	CYPRUS
	13 COLOMBIA (Bogotà - 05:00)	COLOMBIA
	14 COREA DEL SUD (Seul - 19:00)	SOUTH KOREA
	15 COSTA D'AVORIO (Abidjan - 10:00)	IVORY COAST
	16 COSTA RICA (San José - 04:00)	COSTA RICA
	17 CROAZIA (Zagabria - 12:00)	CROATIA
	18 DANIMARCA (Copenaghen - 12:00)	DENMARK
	19 EGITTO (Cairo - 13:00)	EGYPT
	20 EL SALVADOR (San Salvador - 04:00)	EL SALVADOR
	21 EMIRATI ARABI UNITI (Abu Dhabi - 14:00)	UNITED ARAB EMIRATES
	22 ESTONIA (Tallinn - 13:00)	ESTONIA
	23 FINLANDIA (Helsinki - 13:00)	FINLAND
	24 FRANCIA (Parigi - 12:00)	FRANCE
	25 GERMANIA (Berlino - 12:00)	GERMANY
	26 GIAPPONE (Tokyo - 19:00)	JAPAN
	27 GIORDANIA (Amman - 13:00)	JORDAN
	28 GRECIA (Atene - 13:00)	GREECE
	29 INDIA (Nuova Delhi - 15:30)	INDIA
	30 IRLANDA (Dublino - 11:00)	IRELAND
	31 ISLANDA (Reykjavik - 10:00)	ICELAND
	32 ISRAELE (Gerusalemme - 13:00)	ISRAEL
	33 ITALIA (Roma - 12:00)*	ITALY
	34 LETTONIA (Riga - 13:00)	LATVIA
	35 LIBANO (Beirut - 13:00)	LEBANON
	36 LITUANIA (Vilnius - 13:00)	LITHUANIA
	37 MACEDONIA (Skopje - 12:00)	MACEDONIA
	38 MALAISIA (Kuala Lumpur - 18:00)	MALAYSIA
	39 MALTA (Valletta - 12:00)	MALTA
	40 MAROCCO (Rabat - 10:00)	MOROCCO
	41 MESSICO (Città del Messico - 06:00)	MEXICO
	42 NEPAL (Kathmandu - 15:45)	NEPAL
	43 NIGERIA (Abuja - 11:00)	NIGERIA
	44 NORVEGIA (Oslo - 12:00)	NORWAY
	45 NUOVA ZELANDA (Wellington - 22:00)	NEW ZEALAND
	46 OLANDA (Amsterdam - 12:00)	NETHERLANDS
	47 PAKISTAN (Islamabad - 16:00)	PAKISTAN
	48 PERÙ (Lima - 05:00)	PERU
	49 POLONIA (Varsavia - 12:00)	POLAND
	50 PORTOGALLO (Lisbona - 11:00)	PORTUGAL
	51 REGNO UNITO (Londra - 11:00)	UNITED KINGDOM
	52 REPUB. CECA (Praga - 12:00)	CZECH REPUBLIC
	53 REPUB. DOMINICANA (Santo Domingo - 06:00)	DOMINICAN REPUBLIC
	54 REPUB. SLOVACCA (Bratislava - 12:00)	SLOVAKIAN REPUBLIC
	55 ROMANIA (Bucarest - 13:00)	RUMANIA
	56 RUSSIA (Mosca - 14:00)	RUSSIA
	57 SAN MARINO (San Marino - 12:00)	SAN MARINO
	58 SENEGAL (Dakar - 10:00)	SENEGAL
	59 SIRIA (Damasco - 13:00)	SYRIA
	60 SLOVENIA (Lubiana - 12:00)	SLOVENIA
	61 SPAGNA (Madrid - 12:00)	SPAIN
	62 STATI UNITI D'AMERICA (Washington - 06:00)	UNITED STATES OF AMERICA
	63 SUD AFRICA (Pretoria - 12:00)	SOUTH AFRICA
	64 SVEZIA (Stoccolma - 12:00)	SWEDEN
	65 SVIZZERA (Berna - 12:00)	SWITZERLAND
	66 TAIWAN (Taipei - 18:00)	TAIWAN
	67 TUNISIA (Tunisi - 11:00)	TUNISIA
	68 TURCHIA (Ankara - 13:00)	TURKEY
	69 UCRAINA (Kiev - 13:00)	UKRAINE
	70 UGANDA (Kampala - 14:00)	REPUBLIC OF UGANDA
	71 UNGHERIA (Budapest - 12:00)	HUNGARY
	72 VENEZUELA (Caracas - 06:00)	VENEZUELA

Tutti i prodotti NBS® sono costruiti esclusivamente da aziende con Sistema Qualità certificato secondo le norme UNI EN ISO 9001:2000.

All products NBS® are manufactured exclusively by companies with UNI EN ISO 9001:2000 certified Quality System.



... un'ulteriore serie di controlli vengono eseguiti da Laboratori esterni specializzati, attrezzati con moderni strumenti.

Laboratorio Controllo Qualità.

... an additional series of tests are conducted by specialised third party Laboratories using the latest instruments.

Quality Control Laboratory.

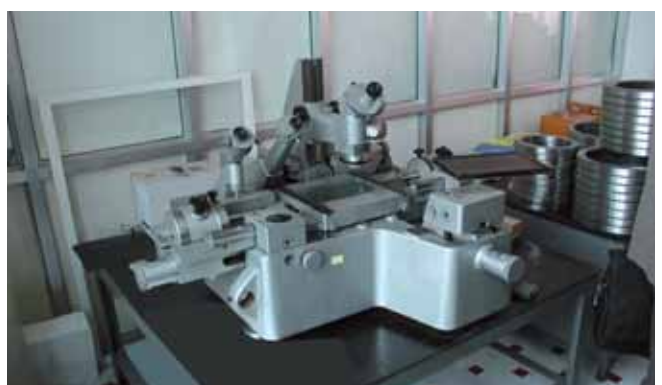
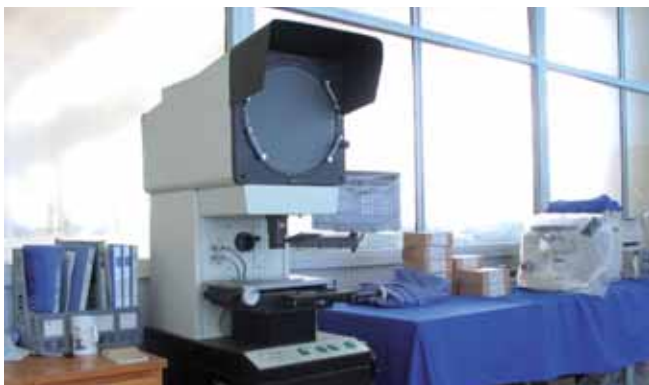

... centro di controllo per la qualità nella nostra sede in ITALIA.
... uno staff di Ingegneri tecnici della Qualità, al vostro servizio.

... a quality control centre is located in our ITALY headquarters.
... our staff of technical engineers at your service, for Quality.



TITOLO - TITLE		Pag. - Page
1.	TIPOLOGIE DI RUOTE LIBERE - TYPES OF FREE WHEELS	2
2.	IMPIEGHI DELLE RUOTE LIBERE - FREE WHEELS APPLICATIONS	3
3.	SELEZIONE - SELECTION	4
3.1	CALCOLO DEL MOMENTO TORCENTE - TORQUE CALCULATION	5
3.2	TABELLA DEI FATTORI DI SERVIZIO (S.F.) - SERVICE FACTOR TABLES (S.F.)	5
3.3	GAMMA DI SELEZIONE - SELECTION OVERVIEW	6
4.	CALETTAMENTO - COUPLING	8
5.	LUBRIFICAZIONE - LUBRICATION	9
6.	INDICE PRODOTTI - PRODUCT INDEX	10
7.	TABELLA DI INTERCAMBIABILITÀ - INTERCHANGEABILITY TABLE	11
	TABELLE DI SELEZIONE	13-28

1 TIPOLOGIE DI RUOTE LIBERE

TYPES OF FREE WHEELS

Una ruota libera è concettualmente assimilabile ad un cuscinetto di tipo volvente, con la differenza che il movimento rotatorio relativo fra i due anelli componenti è consentito esclusivamente in una direzione, cioè è unidirezionale. Questo tipo di funzionamento è reso possibile attraverso una particolare costruzione degli elementi volventi stessi o delle piste su cui risiedono, i quali, nel verso di rotazione "libero" prestabilito, non si oppongono al moto relativo fra l'anello esterno ed interno, mentre, nel momento in cui si inverte il senso di rotazione, tali elementi si oppongono a questa variazione bloccando il sistema. Con il sistema "bloccato" le ruote libere funzionano come una frizione permettendo la trasmissione di coppia motrice/frenante fra albero e alloggiamento.

Esistono fondamentalmente due tipi di ruote libere:

- 1) Ruote libere a camme (KK, DC, RSBW).
- 2) Ruote libere a rulli (HF, HFL, NSS, NFS, AE, NFR, etc. ..).

A freewheel is conceptually similar to a roller bearing, but the relative rotational movement between the outer ring and the inner ring is allowed exclusively in one direction, so it is unidirectional. This feature has been made possible through a special construction of rolling elements themselves or the housing raceways, which, in the "free" pre-established direction do not oppose themselves to the relative motion between the outer and inner rings, whereas, in the moment of the rotation direction is inverted, these elements lock the system. With the system "locked", a free wheel works as a friction and the motor/brake torque transmission between the shaft and the housing is allowed.

There are basically two types of free-wheels:

- 1) Sprag type free wheels with (KK, DC, RSBW)*
- 2) Roller type free wheels (HF, HFL, NSS, NFS, AE, NFR, etc. ..).*



A camme / Sprag type

Le ruote libere a camme sono composte, nella loro versione più semplice, da una serie di camme alloggiata in una struttura a doppia gabbia, e vengono inserite fra due superfici cilindriche in rotazione fra di loro. Il profilo a camma è posto a contatto con le due superfici in rotazione. Quando la rotazione relativa avviene in una direzione la camma rifiuta l'innescio per attrito, quando invece il verso si inverte l'attrito determina la rotazione delle camme fino a che queste, espandendosi, bloccano il sistema.

The sprag type free wheels are composed, on their most simple version, by a series of cams inserted in a double cage structure, and they must be inserted between two rotating cylindrical surfaces. Along one direction cams refused to be engaged by the friction; in the opposite direction friction determines the rotation of the cams until their expansion locks the system.

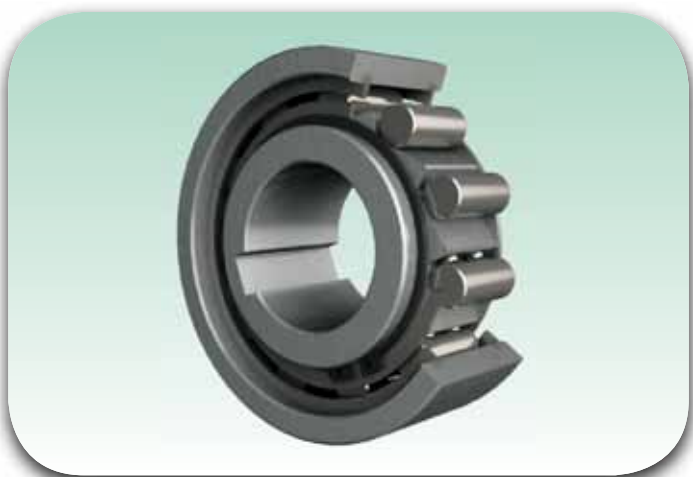

A rulli / Roller type

Le ruote libere a rulli sono composte da due anelli al cui interno vengono alloggiati dei rulli. Per ogni rullo il profilo esterno dell'anello interno mostra una rampa di salita. Quando il verso di rotazione dell'anello esterno avviene nella direzione di salita della rampa, i rulli tendono a muoversi verso l'esterno provocando il blocco del sistema, in quanto vincolano tramite attrito l'anello esterno con quello interno. Nella direzione opposta i rulli sono premuti nelle loro sedi e non interferiscono con il moto.

The roller type free wheel is composed from two rings including cylindrical rollers. For each roller, the inner ring external profile shows a ramp. When the rotation direction between the two rings is along the ramp rising direction, the rollers are moved out from their site and immediately lock the whole system, constraining by friction the inner and the outer ring. On the opposite direction the rollers are pressed in their sites without interfering with the motion.

SUPERO DI VELOCITÀ

Le ruote libere a rulli, qualora impiegate come supero di velocità, devono essere disposte in modo tale che nel campo di supero la parte interna sia ferma o si muova lentamente e la parte esterna superi. Questa disposizione consente un più alto numero di giri di supero, riduce l'usura ed il surriscaldamento, allungando così la vita alla ruota libera di supero. Applicazione tipica: avvio di un motore con motore ausiliario.

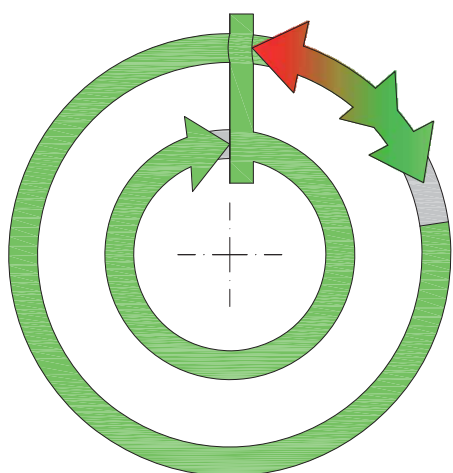

OVERRUNNING

Roller type free wheels, if used as overrunning, must be mounted so that the inner is fixed or moving slowly and the outer ring overruns. This displacement allows a higher overrunning speed, reduces wear and overheating, lengthening the life of the freewheel. Typical application: start of main drive with a auxiliary motor drive shaft.

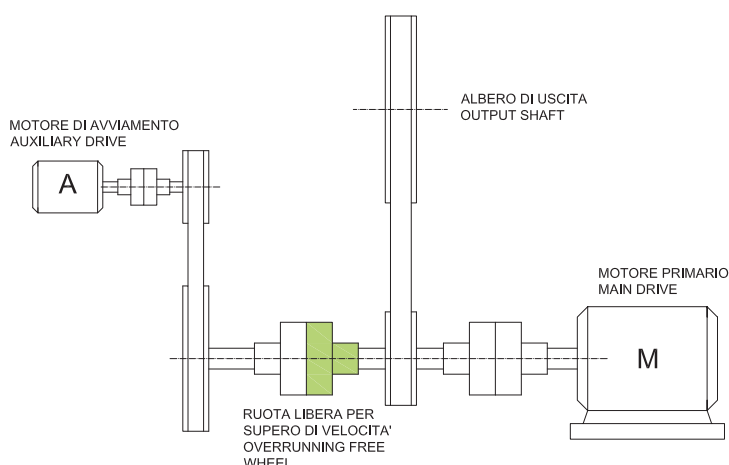

AVANZAMENTO INTERMITTENTE

Le ruote libere impiegate come elementi di avanzamento intermittente affideranno l'avanzamento intermittente alla parte esterna, mentre la trasmissione unidirezionale avverrà tramite l'anello interno. Impiegando una sola ruota i tempi di avanzamento corrispondono esattamente ai tempi morti (funzionamento a vuoto durante il movimento di ritorno). Impiegando due o più ruote libere azionate alternativamente sarà possibile aumentare la frequenza dei moti di avanzamento. Applicazione tipica: linee di processo con avanzamento intermittente.

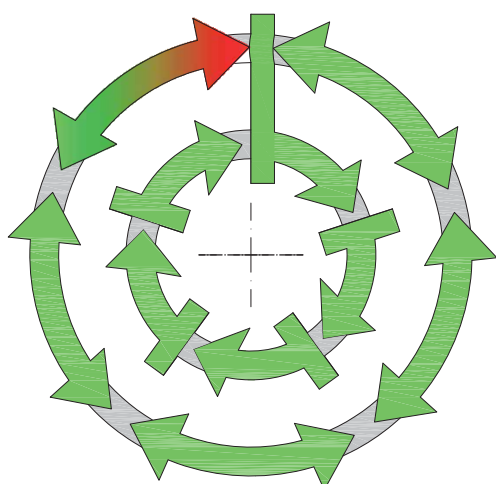

INDEXING

In free wheels used as core element in indexing machines, the intermittent motion will be linked to the outer ring, and the unidirectional transmission will be assigned to the inner ring. With a single free wheel the operational time will match the dead time (during the return movement). Using two or more free wheels it could be improved the frequency of the operational time. Typical application: drive lines with intermittent motion.

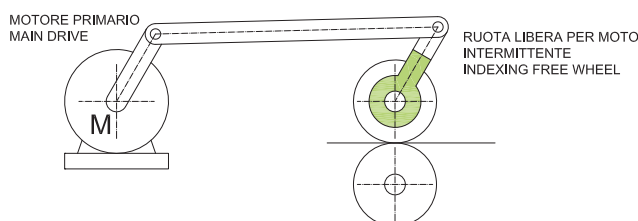

DISPOSITIVO ANTIRITORNO

Se le ruote vengono impiegate come dispositivo antiritorno, il numero di giri di supero può normalmente essere affidato solamente alla parte interna, in questo caso bisogna assolutamente rispettare i giri di supero massimi consentiti e per una buona lubrificazione si consiglia l'impiego di olio a bassa viscosità, possibilmente lubrificazione a circolazione d'olio. Applicazione tipica: sicurezza su impianti di veicolazione unidirezionale di materiali o fluidi.

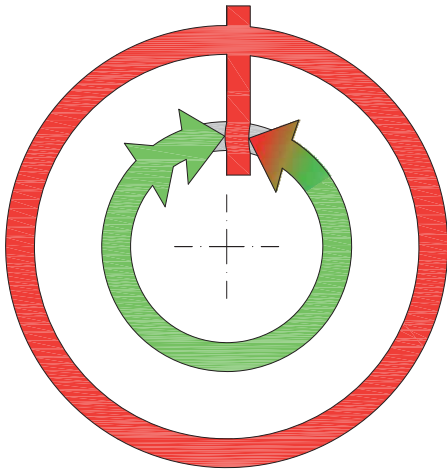

BACKSTOP

If the freewheels are used as a backstop, the overrunning rotation speed is normally assigned to the inner ring: in this case the maximum rotation speed must not be exceeded and for good lubrication it should be proffered the use of a low viscosity oil, possibly with a circulation system. Typical application: unidirectional handling of material or fluids.

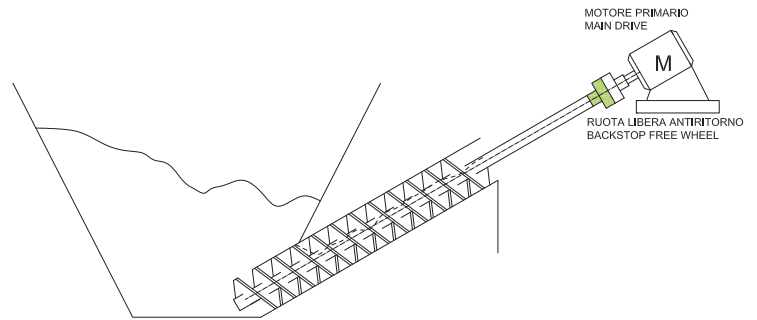

3 SELEZIONE
SELECTION

Gli elementi volventi non hanno funzione sostenitrice e di separazione fra i due anelli, pertanto, se la ruota libera non presenta cuscinetti di supporto integrati (vedi "Tipo di supporto" tabella 3.3), è norma accoppiare un cuscinetto a sfere della serie corrispondente ai suoi diametri di calettamento, identici a quelli delle serie standard di mercato. Ogni ruota libera possiede le sue caratteristiche di massima velocità e massima coppia motrice trasmissibile nella direzione "bloccata", la sua selezione viene quindi fatta in funzione di questi due parametri e del fattore di servizio di quella determinata applicazione.

The roller element do not have the function to bear the loads between the rings, so, if the free-wheel doesn't include built-in bearing support (check "Type of Support" on table 3.3), it is necessary to add a bearing of the correspondent standard market series.

Each free-wheel have own features about overrunning speed and maximum operating torque in the "locked direction", so the selection must be done according the these two parameters, together to the service factor of specific application.

3.1 CALCOLO DEL MOMENTO TORCENTE

TORQUE CALCULATION

Per selezionare una ruota libera serve quindi sapere:

- Coppia nominale da trasmettere C nom (ricavabile dalla potenza P)
- Tipo di applicazione (vedi il fattore di servizio sotto)
- Numero di giri n dell'anello rotante (esterno o interno)

Sotto la formula che riassume questi fattori e definisce la coppia Cop riportata nelle tabelle delle serie:

In order to select a free wheel it needs:

- Nominal torque to be transmitted C nom (to be deducted from the power P)
- Type of application ref to service factor in selection tables
- Nominal rotation speed n of the rotating ring (outer or inner)

Here following the expression that consider whole these factor and define the Cop in the series tables:

$$C_{nom} (Nm) = \frac{95500 \times P (KW)}{n (RPM)}$$

$$C_{op} (Nm) = C_{nom} \times S.F.$$

3.2 TABELLE DEI FATTORI DI SERVIZIO (S.F.)

SERVICE FACTOR TABLES (S.F.)

Applicazione in supero di velocità - *Overrunning application*



Macchina a cui trasmette il moto <i>Driven machine</i>		Condizione di funzionamento / <i>Working conditions</i>			
		Coppia di avviamento non superiore al valore nominale <i>Starting torque not higher than nominal torque</i>	Coppia di avviamento fino a 2 volte il valore nominale <i>Starting torque up to 2 times nominal torque</i>	Coppia di avviamento da 2 a 3 volte il valore nominale <i>Starting torque 2 to 3 times running torque</i>	Coppia di avviamento > 3 volte il valore nominale <i>Starting torque higher than 3 times running torque</i>
		Velocità regolare <i>Smooth drive</i>	Moderate variazioni di carico <i>Moderate load variations</i>	Variazioni di carico <i>Load variations</i>	Alte variazioni di carico <i>High load torque variations</i>
Motore DC / <i>DC motor</i>					
Motore AC con giunto idraulico di collegamento <i>AC motor with soft start or hydraulic coupling</i>		1,30	1,50	1,80	nd
Motore AC con avvio diretto <i>AC motor with direct start</i>	Rapporto di velocità fra motore e supero ruota libera <5 <i>Speed reduction between motor & freewheel < 5</i>	nd	2,50	3,00	4,00
	Rapporto di velocità fra motore e supero ruota libera >4 <i>Speed reduction between motor & freewheel > 4</i>	nd	1,50	1,80	2,30
Turbine a gas o a vapore / <i>Steam or gas turbine</i>		1,30	1,50	—	—
Motori a combustione interna <i>Internal combustion engine</i>	Benzina 4 cilindri / <i>Petrol 4 cyl.</i>	4,00	5,00	nd	nd
	Diesel < 6 cilindri / <i>Diesel < 6 cyl.</i>	5,00	6,00	nd	nd
	Diesel 6 cilindri / <i>Diesel N 6 cyl.</i>	5,00	6,00	nd	nd

Applicazione intermittente - *Indexing application*

Velocità di intermittenza <i>Indexing speed</i>	Tipo di ruota libera / <i>Type of freewheel</i>	
	A rulli / <i>Roller type</i>	A camme / <i>Sprag type</i>
Angolo lavoro < 90° / > 150 colpi/min <i>Angle < 90° / > 150 strokes/min</i>	3,00	4,00
Angolo lavoro > 90° / > 150 colpi/min <i>Angle > 90° / > 150 strokes/min</i>	2,50	4,00
Angolo lavoro > 90° / < 100 colpi/min <i>Angle > 90° / < 100 strokes/min</i>	2,00	3,50

Applicazione Antiritorno - *Backstop application*

Macchina accoppiata <i>Driving machine</i>	Macchina a cui trasmette il moto / <i>Driven machine</i>				
	Nastri trasportatori <i>Elastic conveyor belts</i>	Pompe con più di 5 metri di albero <i>Pump drives with more than 5 metres shaft</i>	Ventilatori <i>Fans</i>	Altre macchine / <i>Other machines</i>	
				Senza sovraccarichi <i>No overloads</i>	Con sovraccarichi <i>Dynamic overloads</i>
Motori con accoppiamento idraulico <i>Motors with hydraulic couplings</i>	1,30	1,60	0,50	1,00	1,50
Motori el. asincroni con avvio diretto <i>Asynchronous motors with direct start</i>	1,60	1,60	0,50	1,00	1,50
Turbine a vapore o a gas <i>Steam or gas turbine</i>	—	1,60	0,50	1,00	1,50
Motori a combustione interna <i>Internal combustion engine</i>	1,60	1,60	0,50	1,00	1,50

Tipo Type	Sistema di blocco Lock system	Applicazione Application	Tipo di supporto Type of support	Utilizzo / Application field		
				SUPERO OVERRUNNING 	INTERMITTENZA INDEX 	ANTIRITORNO BACKSTOP 
HF	Rulli / Rollers	Per coppie basse ed alte velocità. <i>For low torque values and high speed.</i>	Necessario cuscinetto <i>Bearing needed</i>	X	X	X
HFL			Autosupportato <i>Self supported</i>	X	X	X
KK	Camme / Sprags	Ruote libere complete con dimensione basate su serie cuscinetti 62, 60 e 59. <i>Free wheels based on bearing series 62, 60 and 59.</i>	Autosupportato <i>Self supported</i>	X	X	X
KK..2RS				X	X	X
KK..P				X	X	X
KK..PP				X	X	X
KK..P-2RS				X	X	X
KI	Rulli / Rollers	Per coppie elevate e medie basse velocità. Si inseriscono nelle cave dei cuscinetti standard. Richiesta lubrificazione. <i>For high torque transmission and medium-low speed. Must be mounted in the housing of standard bearing. Require lubrication.</i>	Necessario cuscinetto <i>Bearing needed</i>	X	X	X
NSS (AS)				X	X	X
NFS (ASNU)				X	X	X
AE				X	X	X
AA				X	X	X
NF				X	X	X
DC				X	X	X
NFR	Rulli / Rollers	Come sopra ma autosupportata. <i>As above, self supported.</i>	Autosupportato <i>Self supported</i>	X	X	X
RSBW	Camme / Sprags	Complete, autolubrificate a tenuta, montaggio esterno. Built-in, self-contained lubrication, external mounting.	Autosupportato <i>Self supported</i>			X
AV	Rulli / Rollers				X	X
GFR-GFRN	Rulli / Rollers	Complete, autolubrificate a tenuta, montaggio esterno con flangie di accoppiamento. Alta coppia. <i>Complete, self-contained lubrication, external mounting, with mounting flanges. High Torque.</i>	Autosupportato <i>Self supported</i>	X	X	X
GFR..F1F2F7				X	X	X
GFRN..F5F6				X	X	X
GFR..F2F3						X
GFR..F3F4						X

3.3
GAMMA DI SELEZIONE
SELECTION OVERVIEW

Diametro albero [mm] Bore diameter [mm]		Coppia trasmettibile [Nm] Torque allowable [Nm]		Limite velocità/Overrunning speed		Lubrificazione Lubrication	Tipo Type
				An. Interno Inner ring	An. esterno Outer ring		
MIN	MAX	MIN	MAX	[RPM]	[RPM]		
6	35	1,76	121	ALTA HIGH	ALTA HIGH	GRASSO GREASE	HF
8	35	3,15	121				HFL
8	40	2,5	325	ALTA HIGH	ALTA HIGH	GRASSO GREASE	KK
12	40	2,5	325				KK..2RS
12	40	16,9	325				KK..P
12	40	16,9	325				KK..PP
20	30	50	138				KK..P-2RS
4	10	0,8	2,9				MEDIA MEDIUM
6	80	2,1	1063	NSS (AS)			
8	200	12	44500	NFS (ASNU)			
12	70	17	5813	AE			
12	70	17	5913	AA			
8	10	20	44375	NF			
10	70	63	4875	ALTA HIGH	MEDIA MEDIUM		DC
8	30	20	34750	MEDIA MEDIUM	ALTA HIGH		NFR
25	90	375	4875	BASSA LOW	non possibile not possible	GRASSO GREASE	RSBW AV
20	120	265	11000				
12	120	50	20000	MEDIA MEDIUM	ALTA HIGH	OLIO OIL	GFR-GFRN
12	150	55	70000				GFR..F1F2F7
12	150	55	70000				GFRN..F5F6
12	150	55	70000		GFR..F2F3		
12	150	55	70000		GFR..F3F4		

CON LINGUETTA / WITH KEYWAY

Il foro di calettamento della ruota libera, se prevede linguetta ha tolleranza H7. Sull'albero si raccomanda tolleranza h6 o j6.

The bore size of the freewheel, if a keyway is present, shows tolerance H7. We recommend tolerance h6 or j6 for the shaft.

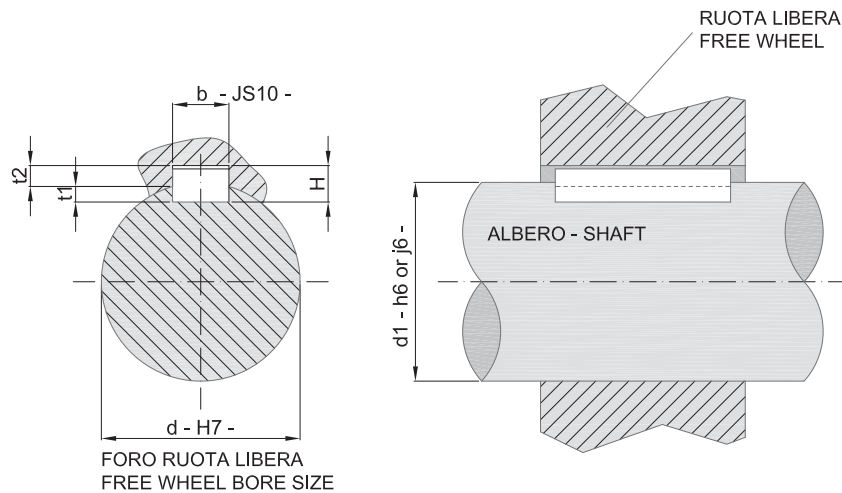

d [H7] [mm]	CALETTAMENTO CON LINGUETTA - COUPLING WITH KEYWAY								Tolleranza dell'albero Shaft tolerance
	DIN 6885.1				DIN 6885.3				
	b JS10 [mm]	h [mm]	t1 [mm]	t2 [mm]	b JS10 [mm]	h [mm]	t1 [mm]	t2 [mm]	
> 6-8	2 ± 0.020	2	1.2 + 0.1	1 + 0.3	-	-	-	-	h6 or j6
> 8-10	3 ± 0.020	3	1.8 + 0.1	1.4 + 0.3	-	-	-	-	
> 10-12	4 ± 0.024	4	2.5 + 0.1	1.8 + 0.3	-	-	-	-	
> 12-17	5 ± 0.024	5	3 + 0.1	2.3 + 0.3	5 ± 0.024	3	1.9 + 0.1	1.2 + 0.3	
> 17-22	6 ± 0.024	6	3.5 + 0.1	2.8 + 0.3	6 ± 0.024	4	2.5 + 0.1	1.6 + 0.3	
> 22-30	8 ± 0.029	7	4 + 0.2	3.3 + 0.4	8 ± 0.029	5	3.1 + 0.1	2 + 0.3	
> 30-38	10 ± 0.029	8	5 + 0.2	3.3 + 0.4	10 ± 0.029	6	3.7 + 0.2	2.4 + 0.3	
> 38-44	12 ± 0.035	8	5 + 0.2	3.3 + 0.4	12 ± 0.035	6	3.9 + 0.2	2.2 + 0.3	
> 44-50	14 ± 0.035	9	5.5 + 0.2	3.8 + 0.4	14 ± 0.035	6	4 + 0.2	2.1 + 0.3	
> 50-58	16 ± 0.035	10	6 + 0.2	4.3 + 0.4	16 ± 0.035	7	4.7 + 0.2	2.4 + 0.3	
> 58-65	18 ± 0.035	11	7 + 0.2	4.4 + 0.4	18 ± 0.035	7	4.8 + 0.2	2.3 + 0.3	
> 65-75	20 ± 0.042	12	7.5 + 0.2	4.9 + 0.4	20 ± 0.042	8	5.4 + 0.2	2.7 + 0.3	
> 75-85	22 ± 0.042	14	9 + 0.2	5.4 + 0.4	22 ± 0.042	9	6 + 0.2	3.1 + 0.4	
> 85-95	25 ± 0.042	14	9 + 0.2	5.4 + 0.4	25 ± 0.042	9	6.2 + 0.2	2.9 + 0.4	
> 95-110	28 ± 0.042	16	10 + 0.2	6.4 + 0.4	28 ± 0.042	10	6.9 + 0.2	3.2 + 0.4	
> 110-130	32 ± 0.050	18	11 + 0.3	7.4 + 0.4	32 ± 0.050	11	7.6 + 0.2	3.5 + 0.4	
> 130-150	36 ± 0.050	20	12 + 0.3	8.4 + 0.4	36 ± 0.050	12	8.3 + 0.2	3.8 + 0.4	

A PRESSIONE / PRESSFIT COUPLING

Dove non c'è una sede di linguetta sia l'anello che quello esterno devono essere calettati per interferenza. Le tolleranze per questo tipo di accoppiamento sono indicate nelle tabelle delle ruote libere che lo prevedono. Come per i cuscinetti standard, utilizzare utensili che non trasmettano il carico assiale alle parti interne delle ruote libere.

In case there no keyway for the coupling, the inner or the outer ring must be mounted with the designed press fitting. Tolerances for press fitting are directly indicated in free wheels tables. As for standard bearings, tools used must not bear inner elements of free wheels, along the axial direction.

Riferirsi alla tabella pag. 6-7 e alla lista sottostante per il tipo di lubrificazione consigliato. Seguire queste regole manutentive:

CON OLIO: prima di montare la ruota libera è necessario rimuovere il fluido anticorrosivo sulle superfici. Il livello dell'olio deve rimanere a circa 1/3 dell'altezza dell'anello interno della ruota libera, montata verticalmente. Evitare gli oli contenenti grafite, molibdeno e di tipo EP2.

CON GRASSO: è richiesta pochissima manutenzione. Ogni due anni, per sicurezza, sarebbe necessario ispezionare ed eventualmente reingrassare l'unità.

















Refer to table pag. 6-7 and below list of lubricant. Please follow these maintenance rules.

WITH OIL: before mounting the freewheel the anti corrosive fluid must be removed. For vertically mounted units the oil level must be 1/3 of the internal ring height. Oils including graphite, molybdenum and EP additives should be avoided.

WITH GREASE: very few maintenance is required. To increase the life the of units we recommend to remove, clean, inspect and re-grease them after two years of operations

OLIO Oil ISO-VG/DIN 51519 mm ² /s	TEMPERATURA DI ESERCIZIO - Operating Temperature				GRASSO Grease
	-20°C to +20°C	+10°C to +50°C	+40°C to +70°C	+50°C to +85°C	
	TEMPERATURA AMBIENTALE - Ambient Temperature				
	-40°C to -15°C	-15°C to +15°C	+15°C to +30°C	+30°C to +50°C	
	10	22	46	100	
	SUMOROL CM10	SUMOROL CM22	SUMUROL CM 46 MOTANOL HE 46	DEGOL CL 100 T MOTANOL HE 100	ARALUB HL2
	ENERGOL CS10	ENERGOL CS22	ENERGOL CS 46 ENERGOL RC-R 46	ENERGOL CS 100 ENERGOL RC 100	ENERGREASE LS2
	-	-	AIRCOL PD 46	AIRCOL PD 100	SPHEEROL MP 2
	SPINESSO 10	SPINESSO 22	TERESSTIC T46	NUTO 100	UNIREX N2
	RENOLIN MR3	RENOLIN DTA22	RENOLIN DTA46	RENOLIN MR30	RENOLIT LZR2
	ISOFLEX PDP 38	ISOFLEX PDP 48	LAMORA HLP 46	LAMORA 100	POLYLUB WH2 Klübersynth BM 44-42
	VELOCITE No 6	VELOCITE No 10	MOBIL DTE 798	MOBIL DTE OIL HEAVY	POLYREX EM
	MORLINA 10	MORLINA 22	MORLINA 46	MORLINA 100	ALVANIA RL2
	AZZOLA ZS10	AZZOLA ZS22	AZZOLA ZS46	AZZOLA ZS100	MULTIS 2

RUOTE LIBERE FREE WHEELS	CARATTERISTICHE FEATURES	SUPPORTO CUSCINETTO BEARING SUPPORT	SOTTOTIPI SUBTYPES	CARATTERISTICHE SOTTOTIPI SUBTYPES FEATURES	Pag.
	Ruote libere ad astuccio <i>Drawn cup roller clutches</i>	 necessario <i>needed</i>	-	con molle in acciaio / <i>with steel springs</i>	12
			.. KF	con molle in plastica / <i>with plastic springs</i>	
			.. R	con molle in acciaio e zigrinatura su anello esterno <i>with steel springs and knurled outer ring</i>	
			.. KFR	con molle in plastica e zigrinatura su anello esterno <i>with plastic springs and knurled outer ring</i>	
	Ruote libere ad astuccio <i>Drawn cup roller clutches</i>	 non necessario <i>not needed</i>	-	con molle in acciaio / <i>with steel springs</i>	13
			.. KF	con molle in plastica / <i>with plastic springs</i>	
			.. R	con molle in acciaio e zigrinatura su anello esterno <i>with steel springs and knurled outer ring</i>	
	Ruote libere a camme <i>Sprag type free wheels</i>	 necessario <i>needed</i>	-	-	14
			.. KF	con molle in plastica / <i>with plastic springs</i>	
			.. R	con molle in acciaio e zigrinatura su anello esterno <i>with steel springs and knurled outer ring</i>	
	Ruote libere a rulli in poliammide <i>Roller type free wheels in polyamide</i>	 necessario <i>needed</i>	-	-	15
	Ruote libere a rulli senza cava <i>Roller type free wheels without keyway</i>	 non necessario <i>not needed</i>	-	non schermato / <i>without shields</i>	16
			2RS	schermato / <i>shielded</i>	
	Ruote libere a rulli con cava <i>Roller type free wheels with keyway</i>	 non necessario <i>not needed</i>	..P	cava su anello interno - <i>keyway on inner ring</i>	17
			..PP	cava su anello interno/ed esterno <i>keyway on outer and inner ring</i>	
			..P-2RS	cava su anello interno con schermatura <i>keyway on inner ring, shielded</i>	
	Ruote libere a rulli con cava interna <i>Roller type free wheel with inner keyway</i>	 necessario <i>needed</i>	-	-	18
	Ruote libere a rulli con cave <i>Roller type free wheel with keyways</i>	 necessario <i>needed</i>	-	-	19
	Ruote libere a rulli con cave <i>Roller type free wheel with keyways</i>	 necessario <i>needed</i>	-	-	20
	Ruote libere a rulli con cava e fori di fissaggio <i>Roller type free wheel with keyway and fixing holes</i>	 necessario <i>needed</i>	-	-	21
	Ruote libere a rulli con cave <i>Roller type free wheel with keyways</i>	 necessario <i>needed</i>	-	-	22
	Ruote libere a rulli con cave <i>Roller type free wheel with keyways</i>	 non necessario <i>not needed</i>	-	-	23
	Ruote libere a camme per montaggio esterno con cava interna, a tenuta <i>Sprag type free wheel with inner keyway for external mounting, self-contained</i>	 non necessario <i>not needed</i>	-	-	24
	Ruote libere a rulli per montaggio esterno con cava interna, a tenuta <i>Roller type free wheel with inner keyway for external mounting, self-contained</i>	 non necessario <i>not needed</i>	-	-	25
	Ruote libere a rulli per montaggio esterno con cava interna, a tenuta <i>Roller type free wheel with inner keyway for external mounting, self-contained</i>	 non necessario <i>not needed</i>	GFR..	senza cava esterna / <i>without outer keyway</i>	26
			GFRN..	con cava esterna / <i>with outer keyway</i>	
	Ruote libere a rulli con cava interna e fori di fissaggio <i>Roller type free wheel with inner keyway and fixing holes</i>	 non necessario <i>not needed</i>	GFR F1F2	GFR con flange tipo 1 e 2 / <i>GFR with flange type 1 and 2</i>	27
			GFR F2F7	GFR con flange tipo 2 e 7 / <i>GFR with flange type 2 and 7</i>	
			GFR F5F6	GFR con flange tipo 5 e 6 / <i>GFR with flange type 5 and 6</i>	
	Ruote libere a rulli per montaggio esterno, con cava interna <i>Roller type free wheel for external mounting, with inner keyway</i>	 non necessario <i>not needed</i>	GFR F2F3	GFR con flange tipo 2 e 3 / <i>GFR with flange type 2 and 3</i>	28
			GFR F3F4	GFR con flange tipo 3 e 4 / <i>GFR with flange type 3 and 4</i>	

Ruote libere - Free Wheels		Corrispondente a... - Equivalent to...				
NBS		RINGSPANN	CTS	STIEBER	GERIT	INA
HF		-	-	-	W, H	HF
HFL		-	-	-	WL, HL	HFL
DC		SF/BWX	-	DC	-	-
KI		-	-	KI	-	-
KK		ZZ	UK	CSK	CSK	-
NSS (AS)		FCN/FCN...R	US	AS (NSS)	AS	-
NFS (ASNU)		FSN/FSN...R	USNU	ASNU (NFS)	ASNU	-
AE		-	-	-	-	-
AA		-	-	AA	-	-
NF		FN...R	UF	NF	-	-
NFR		FNR...R	GF	NFR	ANG - ANR	-
RSBW/AV		FA	GV	RSBW/AV	AV	-
GFR (N)		FGR (P)	GL	GFR (N)	AL (P)	-
GFR F1 F2 F7		FGR A1 A2 A7	GL F2 D2 (D3)	GFR F1 F2 F7	AL /ALM F2 D2/3	-
GFRN F5 F6		FGRN A5 A6	GLP F7 D7	GFRN F5 F6	ALP/ALMP F7 D7	-
GFR F2 F3 F4		FGR A2 A3 A4	GL F5 D2 (D3)	GFR F2 F3 F4	AL /ALM F5 D2/3	-

HF	-	con molle in acciaio / with steel springs
	.. KF	con molle in plastica / with plastic springs
	.. R	con molle in acciaio e zigrinatura su anello esterno / with steel springs and knurled outer ring
	.. KFR	con molle in plastica e zigrinatura su anello esterno / with plastic springs and knurled outer ring

Ruote libere ad astuccio - necessitano supporto con cuscinetto

Drawn cup roller clutches - needle roller bearing support needed

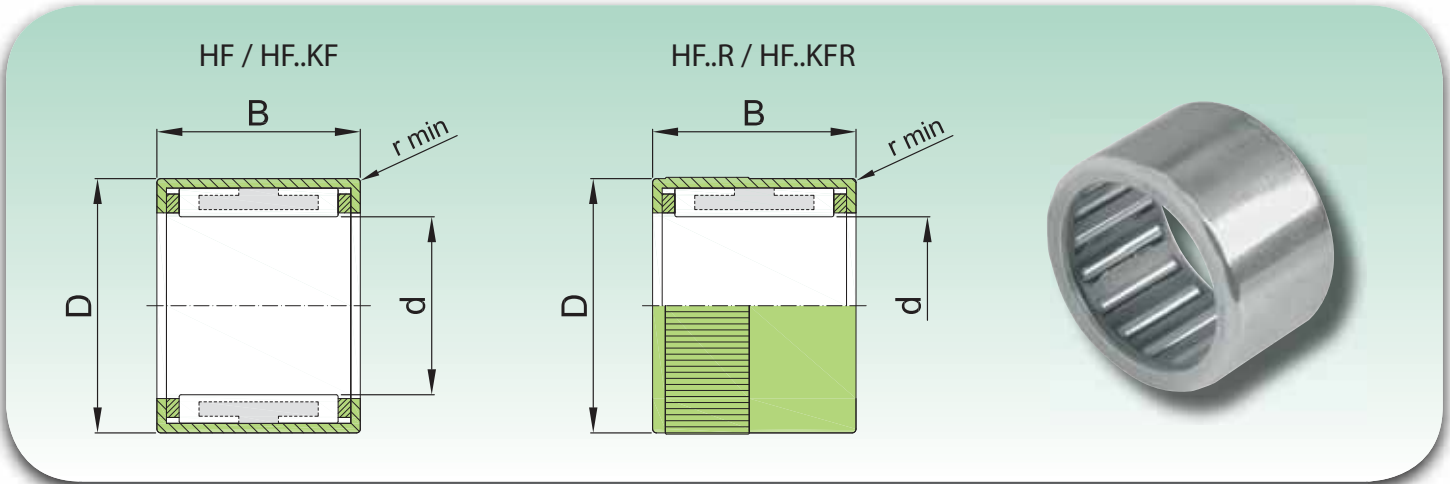

Diametro albero Shaft diameter	Finitura anello esterno Outer ring finishing	Designazione Designation		Dimensioni Dimensions				Coppia torcente trasmissibile Maximum transmittable torque	Velocità di rotazione limite Maximum rotating speed (1)		Cuscinetto a rullini applicabile per supporto radiale Suitable drawn cup needle roller bearings for radial bearing arrangement	Peso Weight
		Molla in acciaio Steel spring	Molla in plastica Plastic spring	d	D	B (0 / 0,3)	r min	C op	Albero Shaft	Anello esterno Outer ring		
				[mm]	[mm]	[mm]	[mm]	[Nm]	[RPM]	[RPM]		[g]
3	normale/normal	-	HF0306KF	3	6,5	6	0,3	0,18	45000	28000	HK0306TN	1
	zigrinato/knurled	-	HF0306KFR	3	6,5	6	0,3	0,06	45000	28000	HK0306TN	1
4	normale/normal	-	HF0406KF	4	8	6	0,3	0,34	34000	14000	HK0408TN	1
	zigrinato/knurled	-	HF0406KFR	4	8	6	0,3	0,1	34000	14000	HK0408TN	1
6	normale/normal	HF0612	HF0612KF	6	10	12	0,3	1,76	23000	13000	HK0608	3
	zigrinato/knurled	HF0612R	HF0612KFR	6	10	12	0,3	0,5	23000	13000	HK0608	3
8	normale/normal	HF0812	HF0812KF	8	12	12	0,3	3,15	17000	12000	HK0808	3,5
	zigrinato/knurled	HF0812R	HF0812KFR	8	12	12	0,3	1	17000	12000	HK0808	3,5
10	normale/normal	HF1012	HF1012KF	10	14	12	0,3	5,3	14000	11000	HK1010	4
	zigrinato/knurled	HF1012R	HF1012KFR	10	14	12	0,3	1,5	14000	11000	HK1010	4
12	normale/normal	HF1216	-	12	18	16	0,3	12,2	11000	8000	HK1212	11
14	normale/normal	HF1416	-	14	20	16	0,3	17,3	9500	8000	HK1412	13
16	normale/normal	HF1616	-	16	22	16	0,3	20,5	8500	7500	HK1612	14
18	normale/normal	HF1816	-	18	24	16	0,3	24,1	7500	7500	HK1812	16
20	normale/normal	HF2016	-	20	26	16	0,3	28,5	7000	6500	HK2010	17
25	normale/normal	HF2520	-	25	32	20	0,3	66	5500	5500	HK2512	30
30	normale/normal	HF3020	-	30	37	20	0,3	90	4500	4500	HK3012	36
35	normale/normal	HF3520	-	35	42	20	0,3	121	3900	3900	HK3512	40

Note / Notes

1) Validi con lubrificazione con grasso e olio
Valid for oil and grease lubrication

Tolleranze per montaggio a pressione / Pressfit coupling tolerances					
Serie Series	Diametro albero Shaft diameter	Tolleranza foro / Housing tolerance			Tolleranza albero Shaft tolerance
		Acciaio Steel	Leggera Light Alloy	Plastica Plastic	
HF / HFL	tutti / all sizes	N6 (N7)	R6 (R7)	-	h5 (h6)
HF..KF HFL..KF	3-4mm	N6 (N7)	R6 (R7)	-	h5 (h6)
	>= 6mm	N7	R7	-	h8
HF..R / HFL..R	tutti / all sizes	-	-	D-0,05	h5 (h6)
HF..KFR HFL..KFR	3-4mm	-	-	D-0,05	h5 (h6)
	>= 6mm	-	-	D-0,05	h8

HFL

-	con molle in acciaio / with steel springs
.. KF	con molle in plastica / with plastic springs
.. R	con molle in acciaio e zigrinatura su anello esterno / with steel springs and knurled outer ring
.. KFR	con molle in plastica e zigrinatura su anello esterno / with plastic springs and knurled outer ring

Ruote libere ad astuccio e con supporto integrato

Drawn cup roller clutches with bearing integrated support

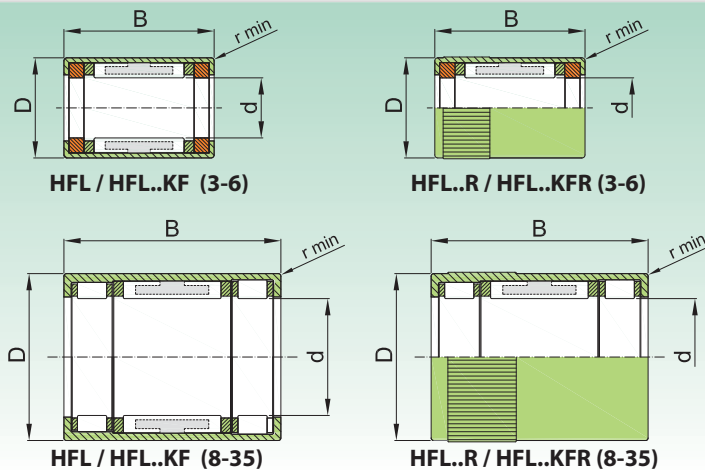

Supporto con cuscinetti a strisciamento / Plain bearing support

Diametro albero Shaft diameter	Finitura anello esterno Outer ring finishing	Designazione Designation		Dimensioni Dimensions				Coppia torcente trasmissibile Maximum transmittable torque C op [Nm]	Velocità di rotazione limite Maximum rotating speed (1)		Carico radiale ammesso Maximum radial load [N]	Fr*n max (2) [N/min]	Peso Weight [g]
		Molla in acciaio Steel spring	Molla in plastica Plastic spring	d	D	B (0/0,3)	r min		Albero Shaft [RPM]	Anello esterno Outer ring [RPM]			
3	normale/normal	-	HFL0308KF	3	6,5	8	0,3	0,18	45000	28000	60	16000	1,4
	zigrinato/knurled	-	HFL0308KFR	3	6,5	8	0,3	0,06	45000	28000	60	16000	1,4
4	normale/normal	-	HFL0408KF	4	8	8	0,3	0,34	34000	14000	80	16000	1,6
	zigrinato/knurled	-	HFL0408KFR	4	8	8	0,3	0,1	34000	14000	80	16000	1,6
6	normale/normal	HFL0615	HFL0615KF	6	10	15	0,3	1,76	23000	13000	110	18000	4
	zigrinato/knurled	HFL0615R	HFL0615KFR	6	10	15	0,3	0,5	23000	13000	110	18000	4

Supporto con cuscinetti volventi / Rolling bearing support

Diametro albero Shaft diameter	Finitura anello esterno Outer ring finishing	Designazione Designation		Dimensioni Dimensions				Coppia torcente trasmissibile Maximum transmittable torque C op [Nm]	Velocità di rotazione limite Maximum rotating speed (1)		Coefficiente di carico radiale cuscinetto Bearing loads radial rating		Carico radiale al limite di fatica Fatigue limit load, radial Cur [N]	Peso Weight [g]
		Molla in acciaio Steel spring	Molla in plastica Plastic spring	d	D	B (0/0,3)	r min		Albero Shaft [RPM]	Anello esterno Outer ring [RPM]	C	C0		
8	normale/normal	HFL0822	HFL0822KF	8	12	22	0,3	3,15	17000	12000	3650	3950	550	7
	zigrinato/knurled	HFL0822R	HFL0822KFR	8	12	22	0,3	1	17000	12000	3650	3950	550	7
10	normale/normal	HFL1022	HFL1022KF	10	14	22	0,3	5,3	14000	11000	3950	4500	630	8
	zigrinato/knurled	HFL1022R	HFL1022KFR	10	14	22	0,3	1,5	14000	11000	3950	4500	630	8
12	normale/normal	HFL1226	-	12	18	26	0,3	12,2	11000	8000	6300	6700	920	18
14	normale/normal	HFL1426	-	14	20	26	0,3	17,3	9500	8000	6800	7800	1080	20
16	normale/normal	HFL1626	-	16	22	26	0,3	20,5	8500	7500	7400	9000	1250	22
18	normale/normal	HFL1826	-	18	24	26	0,3	24,1	7500	7500	8000	10200	1420	25
20	normale/normal	HFL2026	-	20	26	26	0,3	28,5	7000	6500	8500	11400	1590	27
25	normale/normal	HFL2530	-	25	32	30	0,3	66	5500	5500	10600	14000	1900	44
30	normale/normal	HFL3030	-	30	37	30	0,3	90	4500	4500	11600	16900	2290	51
35	normale/normal	HFL3530	-	35	42	30	0,3	121	3900	3900	12200	18800	2550	58

Note / Notes

1) Validi con lubrificazione con grasso e olio / Valid for oil and grease lubrication

2) Fr= carico radiale effettivo / radial load applied

n= velocità di rotazione effettiva / effective rotating speed

Tolleranze per montaggio a pressione vedi pag. 12 / Pressfit coupling tolerances ref. to page 12

Ruote libere a camme - necessitano sedi di rotolamento e supporto con cuscinetto
Sprag type free wheels - raceways and bearing support needed

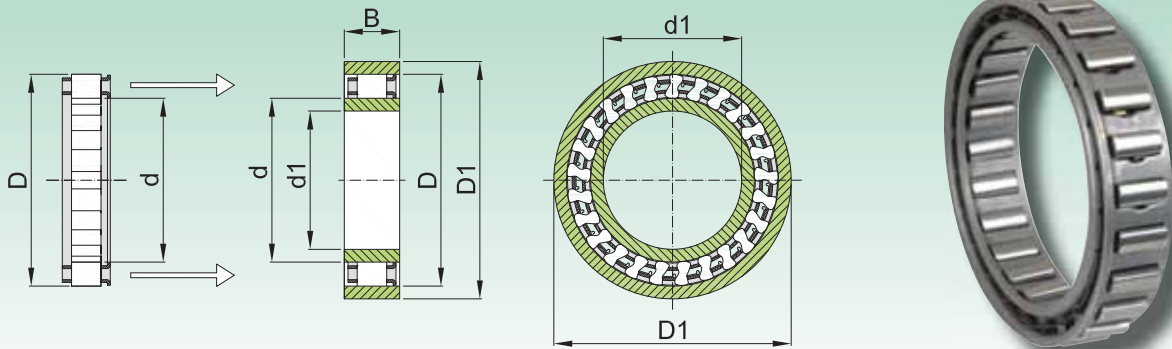

Designazione <i>Designation</i>	Dimensioni <i>Dimensions</i>				Dimensioni sede <i>Housing dimensions</i>		Coppia massima di funzionamento <i>Maximum operating torque</i>	Velocità limite della pista <i>Overrunning speeds of race</i>		Numero di agganci <i>Number of dips</i>	Numero di camme <i>Number of sprags</i>	Peso <i>Weight</i>	
	d	D	Spessore camma <i>Sprag width</i>	B	D1 max	d1 min		C op (1)	Interna <i>Inner</i>				Esterna <i>Outer</i>
	[mm]	[mm]	[mm]	[mm]	[mm]	[mm]		[Nm]	[RPM]				[RPM]
DC2222G-N	22,225	38,885	8,33 ±0,1	10,0	50	15	63	8600	4300	-	12	0,030	
DC2776-N	27,762	44,422	8,33 ±0,1	13,5	58	18	119	6900	3400	-	14	0,055	
DC3034-N	30,340	47,000	8,33 ±0,1	13,5	62	20	124	6300	3100	-	14	0,060	
DC3175(3C)-N	31,750	48,410	8,33 ±0,1	13,5	63	21	159	6000	3000	3	16	0,060	
DC3809A-N	38,092	54,752	8,33 ±0,1	16,0	71	25	275	5000	2500	-	18	0,085	
DC4127(3C)-N	41,275	57,935	8,33 ±0,1	13,5	75	27	224	4600	2300	3	18	0,090	
DC4445A-N	44,450	61,110	8,33 ±0,1	16,0	79	29	363	4300	2100	-	20	0,095	
DC4972(4C)-N	49,721	66,381	8,33 ±0,1	13,5	86	33	306	3800	1900	4	22	0,100	
DC5476A-N	54,765	71,425	8,33 ±0,1	16,0	92	36	525	3500	1700	-	24	0,110	
DC5476A(4C)-N	54,765	71,425	8,33 ±0,1	16,0	92	36	525	3500	1700	4	24	0,130	
DC5476B(4C)-N	54,765	71,425	8,33 ±0,1	21,0	92	36	769	3500	1700	4	24	0,180	
DC5476C(4C)-N	54,765	71,425	8,33 ±0,1	25,4	92	36	990	3500	1700	4	24	0,200	
DC5776A-N	57,760	74,420	8,33 ±0,1	16,0	98	38	604	3300	1600	-	26	0,110	
DC6334B-N	63,340	80,000	8,33 ±0,1	21,0	104	42	806	3000	1500	-	26	0,175	
DC7221(5C)-N	72,217	88,877	8,33 ±0,1	13,5	115	48	675	2600	1300	5	30	0,140	
DC7221B-N	72,217	88,877	8,33 ±0,1	21,0	115	48	1279	2600	1300	-	30	0,185	
DC7221B(5C)-N	72,217	88,877	8,33 ±0,1	21,0	115	48	1279	2600	1300	5	30	0,210	
DC7969C(5C)-N	79,698	96,358	8,33 ±0,1	25,4	124	53	2038	2400	1200	5	34	0,280	
DC8334C-N	83,340	100,000	8,33 ±0,1	25,4	132	55	2055	2300	1100	-	34	0,270	
DC8729A-N	87,290	103,960	8,33 ±0,1	16,0	134	58	1250	2200	1100	-	34	0,165	
DC10323A(5C)-N	103,231	119,891	8,33 ±0,1	16,0	155	68	1612	1800	900	5	40	0,205	
DC12334C-N	123,34	140,000	8,33 ±0,1	25,4	184	80	4800	1500	750	-	50	0,400	
DC12388C(11C)	123,881	142,880	9,50 ±0,1	25,4	186	80	4875	1500	750	11	44	0,400	

KI

Ruote libere a rulli in poliammide - necessitano supporto con cuscinetto

Roller type free wheels in polyamide - bearing support needed

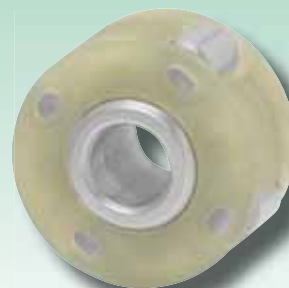
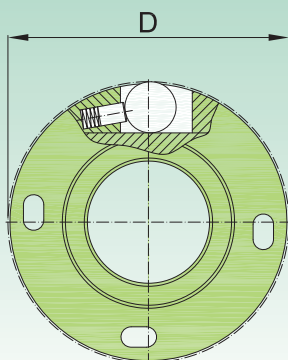
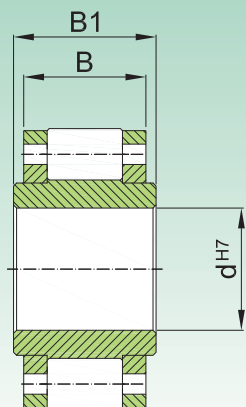

Tipo Type	Misura Size	Coppia massima di funzionamento Maximum operating torque	Velocità limite Overrunning speed of		Dimensioni Dimensions				Massa Weight
	d	C _{op} (1)	Anello interno Inner ring	Anello esterno Outer ring	DH7	dH7	B1	B	
	[mm]	[Nm]	[RPM]	[RPM]	[mm]	[mm]	[mm]	[mm]	
KI	164	0,8	8000	10000	16	4	10	9	0,008
	165	0,8	8000	10000	16	5	10	9	0,007
	194	0,9	7000	9000	19	4	10	9	0,012
	195	0,9	7000	9000	19	5	10	9	0,011
	196	0,9	7000	9000	19	6	10	9	0,010
	268*	2,9	5000	6000	26	8	14	13	0,023
	269*	2,9	5000	6000	26	9	14	13	0,021
	2610*	2,9	5000	6000	26	10	14	13	0,019

NOTE / Notes

Designazione/designation KI+d - esempio/example: KI195

1) C_{max} = 2 × C_{op}

* Possibilità per cava / Possibility for keyway DIN 6885.1

KK	-	non schermato / without shields
	2RS	schermato / shielded

Ruote libere a rulli senza cava - non necessitano supporto con cuscinetto
Roller type free wheels without keyway - not bearing support needed

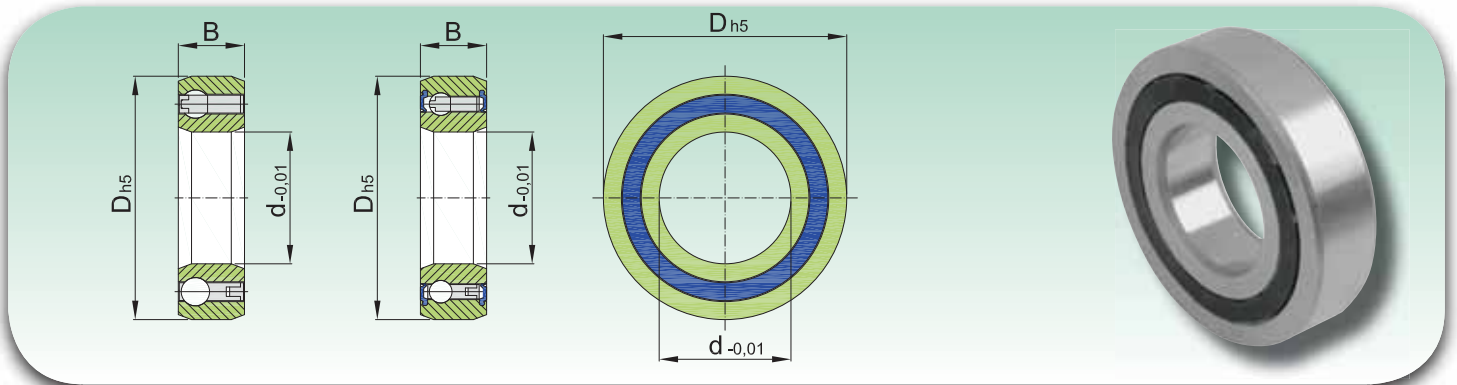

Tipo Type	Misura Size	Dimensioni Dimensions		Coppia massima di funzionamento Maximum operating torque	Velocità limite Overrunning speed	Serie cuscinetti Bearing series	Carichi cuscinetto Bearing loads		Peso Weight	Coppia di trascinamento Drag torque
							dinamico dynamic	statico static		
							C	C0		
	d	D	B	C op (1)	n max					
	[mm]	[mm]	[mm]	[Nm]	[RPM]		[kN]	[kN]	[kg]	[Ncm]
KK	8	22	9	2,5	15000	no std	3,28	0,86	0,015	0,5
	12	32	10	9,3	10000	6201	6,1	2,77	0,04	0,7
	15	35	11	17	8400	6202	7,4	3,42	0,06	0,9
	17	40	12	30	7350	6203	7,9	3,8	0,070	1,1
	20	47	14	50	6000	6204	9,4	4,46	0,110	1,3
	25	52	15	85	5200	6205	10,7	5,46	0,140	2,0
	30	62	16	138	4200	6206	11,7	6,45	0,210	4,4
	35	72	17	175	3600	6207	12,6	7,28	0,300	5,8
KK..2RS	40	80	22	325	3000	no std	15,54	12,25	0,5	7,0
	8	22	9	2,5	15000	no std	3,28	0,86	0,015	0,8
	12	32	14	9,3	10000	no std	6,1	2,77	0,05	3,0
	15	35	16	17	8400	no std	7,4	3,42	0,070	4,0
	17	40	17	30	7350	no std	7,9	3,8	0,09	5,6
	20	47	19	50	6000	no std	9,4	4,46	0,145	6,0
	25	52	20	85	5200	no std	10,7	5,46	0,175	6,0
	30	62	21	138	4200	no std	11,7	6,45	0,270	7,5
35	72	22	175	3600	no std	12,6	7,28	0,400	8,2	
40	80	27	325	3000	no std	15,54	12,25	0,6	10	

NOTE / Notes

Designazione/designation KK+d - esempio/example: KK20

1) C_{max} = 2 × C_{op}

KK	..P	cava su anello interno / keyway on inner ring
	..PP	cava su anello interno/ed esterno keyway on outer and inner ring
	..P-2RS	cava su anello interno con schermatura keyway on inner ring, shielded



Ruote libere a rulli con cava - non necessitano supporto con cuscinetto
Roller type free wheels with keyway - not bearing support needed

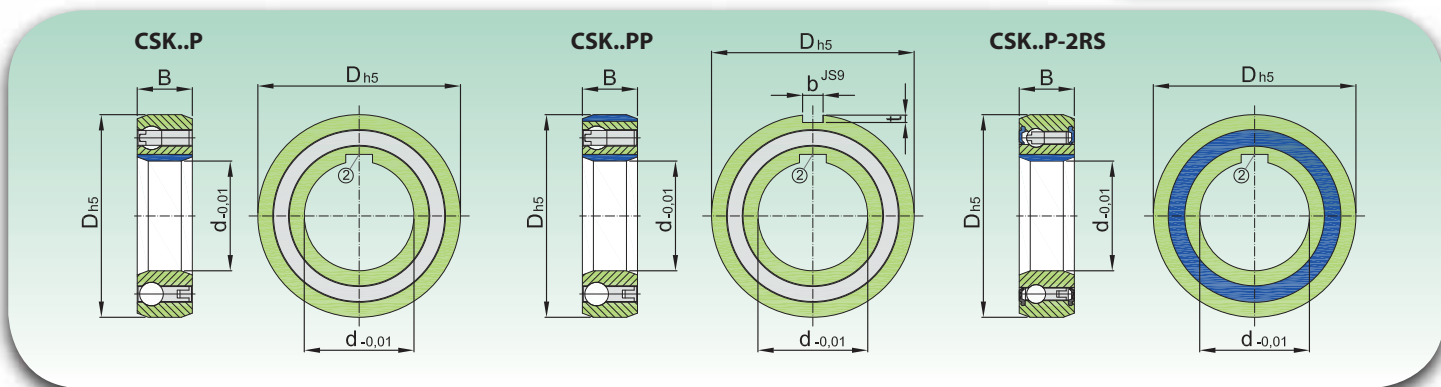

Tipo Type	Misura Size	Dimensioni Dimensions				Coppia massima di funzionamento Maximum operating torque	Velocità limite Overrunning speed	Serie cuscinetti Bearing series	Carichi cuscinetto Bearing loads		Peso weight	Coppia di trascinamento Drag torque			
		d	D	B	b				t	C op (1)			n max	dinamico	statico
														C	C0
[mm]	[mm]	[mm]	[mm]	[mm]	[Nm]	[RPM]				[kg]	[Ncm]				
KK..P	12	32	10	-	-	9,3	10000	6201	6,1	2,77	0,04	0,7			
	15	35	11	-	-	17	8400	6202	7,4	3,42	0,06	0,9			
	17	40	12	-	-	30	7350	6203	7,9	3,8	0,070	1,1			
	20	47	14	-	-	50	6000	6204	9,4	4,46	0,110	1,3			
	25	52	15	-	-	85	5200	6205	10,7	5,46	0,140	2,0			
	30	62	16	-	-	138	4200	6206	11,7	6,45	0,210	4,4			
	35	72	17	-	-	175	3600	6207	12,6	7,28	0,300	5,8			
	40 ⁽²⁾	80	22	-	-	325	3000	-	15,54	12,25	0,5	7,0			
KK..PP	15	35	11	2	0,6	17	8400	6202	7,4	3,42	0,06	0,9			
	17	40	12	2	1,0	30	7350	6203	7,9	3,8	0,070	1,1			
	20	47	14	3	1,5	50	6000	6204	9,4	4,46	0,110	1,3			
	25	52	15	6	2,0	85	5200	6205	10,7	5,46	0,140	2,0			
	30	62	16	6	2,0	138	4200	6206	11,7	6,45	0,210	4,4			
	35	72	17	8	2,5	175	3600	6207	12,6	7,28	0,300	5,8			
	40 ⁽²⁾	80	22	10	3,0	325	3000	-	15,54	12,25	0,5	7,0			
KK..P-2RS	12	32	14	-	-	9,3	10000	-	6,1	2,77	0,05	3			
	15	35	16	-	-	17	8400	-	7,4	3,42	0,07	4			
	17	40	17	-	-	30	7350	-	7,9	3,8	0,09	5,6			
	20	47	19	-	-	50	6000	-	9,4	4,46	0,145	6,0			
	25	52	20	-	-	85	5200	-	10,7	5,46	0,175	6,0			
	30	62	21	-	-	138	4200	-	11,7	6,45	0,270	7,5			
	35	72	22	-	-	175	3600	-	12,6	7,28	0,4	8,2			
	40 ⁽²⁾	80	27	-	-	325	3000	-	15,54	12,25	0,6	10			

NOTE / Notes

Designazione/designation KK+d PP - esempio/example: KSK20 PP

1) Cmax = 2 x Cop

2) Cava anello interno / Inner ring keyway DIN 6885.3 - Vedi / See pag. 8

Misura/Size KK40 - Cava / Keyway DIN 6885.1 - Vedi / See pag. 8

NSS (AS)

Ruote libere a rulli con cava interna - necessitano supporto con cuscinetto
Roller type free wheel with inner keyway - bearing support needed

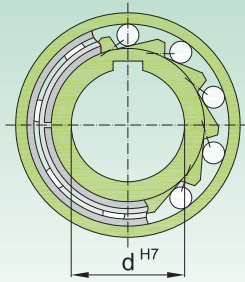
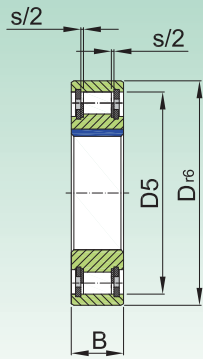

Tipo Type	Misura Size	Dimensioni Dimensions				Coppia massima di funzionamento Maximum operating torque	Velocità limite Overrunning speed of		Peso Weight	Coppia di trascinamento Drag torque
	d H7	D r6	D5	B	s	C op (1)	Anello interno Inner ring	Anello esterno Outer ring		C dr
	[mm]	[mm]	[mm]	[mm]	[mm]	[Nm]	[RPM]	[RPM]	[kg]	[Ncm]
NSS (AS)	6	19	15,8	6	0,3	2,10	5000	7500	0,01	0,18
	8	24	20	8	1,3	3,8	4300	6500	0,02	0,24
	10	30	25,9	9	1,3	6,8	3500	5200	0,03	0,36
	12	32	28	10	1,3	13	3200	4800	0,04	0,48
	15	35	31	11	1,4	14	2800	4300	0,05	0,70
	20	47	40	14	2,4	40	2200	3300	0,12	1,4
	25	52	45,9	15	2,4	56	1900	2900	0,14	2,4
	30	62	55	16	2,4	90	1600	2400	0,22	7,8
	35	72	64	17	2,5	143	1300	2000	0,31	9,0
	40	80	72	18	2,5	185	1200	1800	0,39	10
	45	85	77	19	2,5	218	1000	1600	0,44	11
	50	90	82	20	2,5	230	950	1500	0,49	13
	55	100	90	21	2,5	308	800	1300	0,66	14
	60	110	100	22	2,5	508	700	1100	0,81	26
80	140	128	26	2,5	1063	600	900	1,41	58	

NOTE / Notes

Designazione/Designation NSS+d esempio/ example: NSS15

Dimensioni di montaggio identiche a cuscinetti a sfere serie 62 / Mounting dimensions are identical to ball bearings series 62

NSS6 senza cava / without keyway ØD = 0/-009

NSS 8-12 cava / keyway DIN 6885.1 - Vedi / See pag. 8

Altre misure cava / Other sizes keyway DIN 6885.3 - Vedi / See pag. 8

1) Cmax = 2 × C op

NFS (ASNU)

Ruote libere a rulli con cave - necessitano supporto con cuscinetto
Roller type free wheel with keyways - bearing support needed

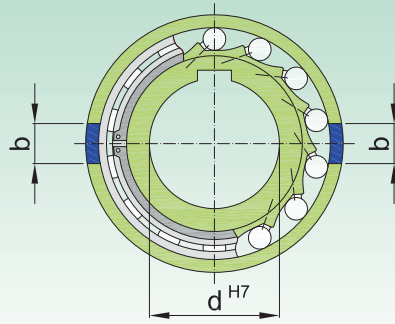
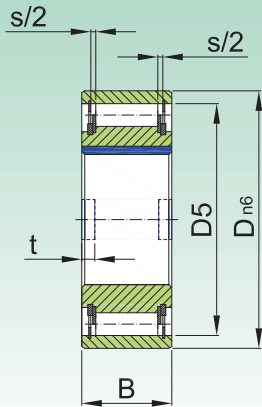

Tipo Type	Misura Size	Dimensioni Dimensions						Coppia massima di funzionamento Maximum operating torque	Velocità limite Overrunning speed of		Peso Weight	Coppia di trascinamento Drag torque
	d H7	D n6	B	D 5	b	t	s	C op (1)	Anello interno Inner ring	Anello esterno Outer ring		C dr
	[mm]	[mm]	[mm]	[mm]	[mm]	[mm]	[mm]	[Nm]	[RPM]	[RPM]	[kg]	[Ncm]
NFS (ASNU)	8	35	13	28	4	1,4	2,4	12	3300	5000	0,07	1,6
	12	35	13	28	4	1,4	2,4	12	3300	5000	0,06	1,6
	15	42	18	37	5	1,8	2,4	30	2400	3600	0,11	1,9
	17	47	19	40	5	2,3	2,4	49	2300	3400	0,15	1,9
	20	52	21	42	6	2,3	2,4	78	2100	3100	0,19	1,9
	25	62	24	51	8	2,8	2,4	125	1700	2600	0,38	5,6
	30	72	27	60	10	2,5	2,4	255	1400	2200	0,54	14
	35	80	31	70	12	3,5	2,4	383	1200	1900	0,74	16
	40	90	33	78	12	4,1	2,5	538	1100	1700	0,92	38
	45	100	36	85	14	4,6	2,5	780	1000	1600	1,31	43
	50	110	40	92	14	5,6	2,5	1013	850	1350	1,74	55
	60	130	46	110	18	5,5	3,6	1825	750	1050	2,77	110
	70	150	51	125	20	6,9	3,6	2300	600	950	4,16	140
	80	170	58	140	20	7,5	3,6	3275	550	850	6,09	180
	90	190	64	160	20	8,0	3,6	5325	500	750	8,2	230
	100	215	73	175	24	8,5	3,6	7250	450	680	12,6	380
	120	260	86	215	28	10	3,6	13500	370	550	22	650
150	320	108	260	32	12	3,6	26625	300	460	42	1000	
200	420	138	350	45	16	7,6	44500	230	350	93	2000	

NOTE / Notes

Designazione/Designation NFS+d - esempio/ example: NFS50

NFS 8-12 & NFS200 cava / keyway DIN 6885.1 - **Vedi / See pag. 8**

Altre misure cava / Other sizes keyway DIN 6885.3 - **Vedi / See pag. 8**

1) Cmax = 2 × C op

AE

Ruote libere a rulli con cave - necessitano supporto con cuscinetto
Roller type free wheel with keyways - bearing support needed

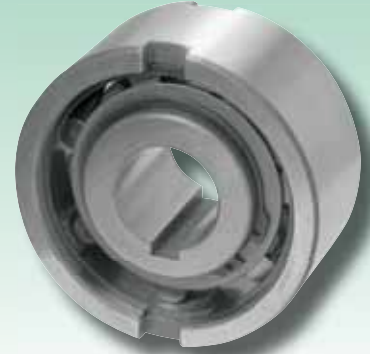
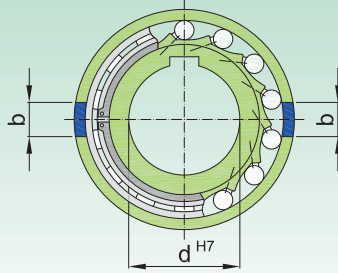
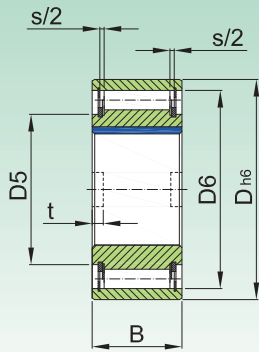

Tipo Type	Misura Size	Dimensioni Dimensions							Coppia massima di funzionamento Maximum operating torque	Velocità limite Overrunning speed of		Peso Weight	Coppia di trascinamento Drag torque
	d H7	Dh6	D6	D5	B	s	b H11	t	C op (1)	Anello interno Inner ring	Anello esterno Outer ring		C dr
	[mm]	[mm]	[mm]	[mm]	[mm]	[mm]	[mm]	[mm]	[Nm]	[RPM]	[RPM]		[kg]
AE	12	37	28	20	20	4,5	6	3	17	3100	6000	0,11	0,7
	15	47	37	26	30	4,5	7	3,5	55	2300	5400	0,30	3,5
	20	62	50	35	34	5,5	8	3,5	146	2000	3600	0,55	8,4
	25	80	68	45	37	6,5	9	4	285	1700	2600	0,98	14
	30	90	75	50	44	6,2	12	5	500	1500	2100	1,50	23
	35	100	80	55	48	3,8	13	6	720	1300	1950	2,00	60
	40	110	90	60	56	3,8	15	7	1030	1200	1700	2,80	72
	45	120	95	65	56	3,8	16	7	1125	1050	1600	3,30	140
	50	130	110	75	63	5,8	17	8	2150	950	1300	4,20	180
	55	140	115	82	67	3,8	18	9	2675	850	1200	5,20	190
	60	150	125	90	78	7,6	18	9	3500	800	1100	6,80	240
70	170	140	100	95	7,6	20	9	5813	650	900	10,5	320	

NOTE / Notes

Designazione/Designation AE+d - esempio/ example: AE100

Cava / Keyway DIN 6885.1 - Vedi / See pag. 8

1) Cmax = 2 × C op

AA

Ruote libere a rulli con cava e fori di fissaggio - necessitano supporto con cuscinetto
Roller type free wheel with keyway and fixing holes - bearing support needed

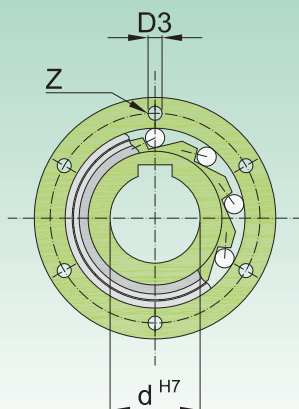
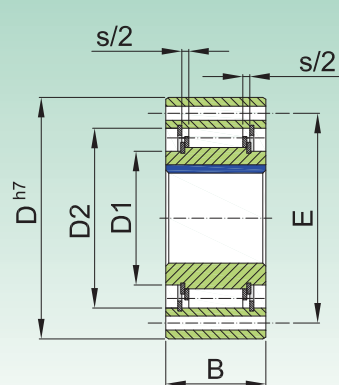

Tipo Type	Misura Size	Coppia massima di funzionamento Maximum operating torque	Velocità limite Overrunning speed of		Dimensioni Dimensions								Peso Weight	Coppia di trascinamento Drag torque
	d	C op (1)	Anello interno Inner ring	Anello esterno Outer ring	Dh7	B	D2	D1	E	Z	D3	s		C dr
	[mm]	[Nm]	[RPM]	[RPM]	[mm]	[mm]	[mm]	[mm]	[mm]	-	[mm]	[mm]	[kg]	[Ncm]
AA	12	17	3100	6000	47	20	28	20	38	3	5,5	4,5	0,21	0,7
	15	55	2300	5400	55	30	37	26	45	3	5,5	4,5	0,44	3,5
	20	146	2000	3600	68	34	50	35	58	4	5,5	5,5	0,70	8,4
	25	285	1700	2600	90	37	68	45	78	6	5,5	6,5	1,30	14
	30	500	1500	2100	100	44	75	50	87	6	6,6	6,5	2,00	23
	35	720	1300	1950	110	48	80	55	96	6	6,6	6,5	2,60	60
	40	1030	1200	1700	125	56	90	60	108	6	9	7,6	3,90	72
	45	1125	1050	1500	130	56	95	65	112	8	9	7,6	4,00	140
	50	2150	950	1300	150	63	110	75	132	8	9	7,6	6,00	180
	55	2675	850	1200	160	67	115	82	138	8	11	7,6	7,20	190
	60	3500	800	1100	170	78	125	90	150	10	11	7,6	9,20	240
	70	5813	650	900	190	95	140	100	165	10	11	7,6	11,8	320

NOTE / Notes

Designazione/Designation AA+d - esempio/ example: AA100

Cava / Keyway DIN 6885.1 - **Vedi / See pag. 8**

1) $C_{max} = 2 \times C_{op}$

Ruote libere a rulli con cave - necessitano supporto con cuscinetto
Roller type free wheel with keyways - bearing support needed

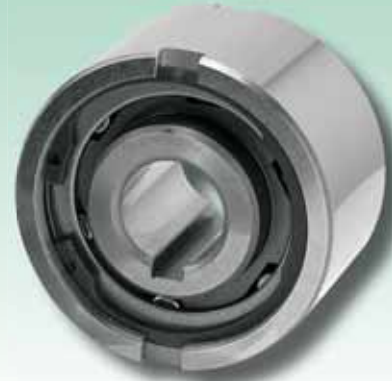
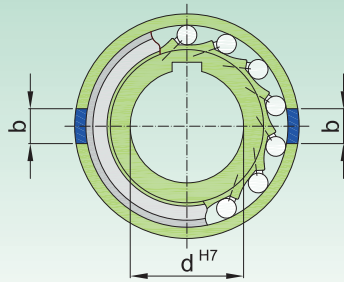
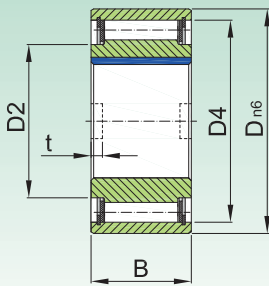

Tipo Type	Misura Size	Dimensioni Dimensions						Coppia massima di funzionamento Maximum operating torque	Velocità limite Overrunning speed of race		Peso Weight
	d H7	Dn6	D4	D2	B	t	b H11	C op (1)	Anello interno Inner ring	Anello esterno Outer ring	
	[mm]	[mm]	[mm]	[mm]	[mm]	[mm]	[mm]	[Nm]	[RPM]	[RPM]	
NF	8	37	30	20	20	3	6	20	5000	6000	0,1
	12	37	30	20	20	3	6	20	5000	6000	0,1
	15	47	37	26	30	3,5	7	78	4500	5400	0,3
	20	62	52	37	36	3,5	8	188	3000	3600	0,6
	25	80	68	49	40	4	9	250	2200	2600	1,1
	30	90	75	52,5	48	5	12	500	1800	2100	1,6
	35	100	80	58	53	6	13	663	1600	1950	2,3
	40	110	90	62	63	7	15	1100	1250	1700	3,1
	45	120	95	69	63	7	16	1500	1100	1500	3,7
	50	130	110	82	80	8,5	17	2375	850	1300	5,4
	55	140	115	83	80	9	18	2500	800	1200	6,1
	60	150	125	93,5	95	9	18	4250	700	1100	8,5
	70	170	140	106	110	9	20	5875	620	900	13,0
	80	190	160	122	125	9	20	10000	550	800	18,0
	90	215	180	133	140	11,5	24	17250	480	700	25,3
	100	260	210	157	150	14,5	28	19625	400	600	42,1
130	300	240	188	180	17	32	34750	300	480	65,0	
150	320	260	205	180	17	32	44375	250	400	95,0	

NOTE / Notes

Designazione/Designation NF+d - esempio/ example: NF100

Cava / Keyway DIN 6885.1 - Vedi / See pag. 8

1) Cmax = 2 × C op

NFR

Ruote libere a rulli con cave autosupportate da cuscinetti a sfere

Roller type free wheel with keyways, self-supported by ball bearings



NFR 8-20

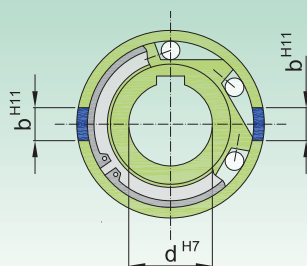
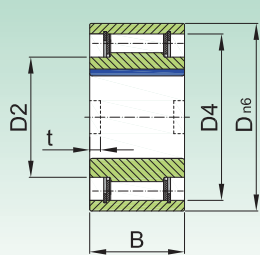

NFR 25-130

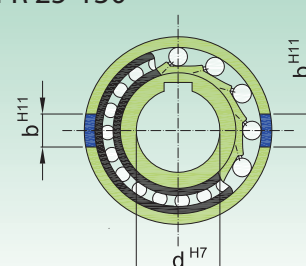
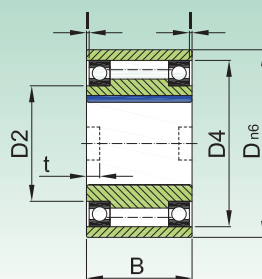

Tipo Type	Misura Size	Coppia massima di funzionamento Maximum operating torque	Velocità limite Overrunning speed of race		Serie cuscinetti Bearing series	Dimensioni Dimensions							Peso Weight	
			C op (1)	Anello interno Inner ring		Anello esterno Outer ring	Dn6	D4	D2	B	l	t		b H11
"NFR"	[mm]	[Nm]	[RPM]	[RPM]		[mm]	[mm]	[mm]	[mm]	[mm]	[mm]	[mm]	[mm]	[kg]
NFR	8	20	1000	1000	*	37	30	20	20		3	6	0,1	
	12	20	1000	1000	*	37	30	20	20		3	6	0,1	
	15	78	850	850	*	47	37	26	30		3,5	7	0,3	
	20	188	650	650	*	62	52	37	36		3,5	8	0,6	
	25	250	2100	3600	16008**	80	68	40	40	0,2	4	9	1,2	
	30	500	1700	3200	16009**	90	75	45	48	0,2	5	12	1,8	
	35	663	1550	3000	16010**	100	80	50	53	1,2	6	13	2,4	
	40	1100	1150	2600	16011**	110	90	55	63	2,2	7	15	3,3	
	45	1500	1000	2400	16012**	120	95	60	63	2,2	7	16	4,0	
	50	2375	800	2150	16014**	130	110	70	80	2,7	8,5	17	5,7	
	55	2550	750	2000	16015**	140	115	75	80	4,2	9	18	6,5	
	60	4250	650	1900	16016**	150	125	80	95	3,2	9	18	8,9	
	70	5875	550	1750	16018**	170	140	90	110	1,1	9	20	13,5	
	80	10000	500	1600	16021**	190	160	105	125	0	9	20	19,0	
	90	17250	450	1450	16024**	215	180	120	140	0,6	11,5	24	27,2	
100	19625	350	1250	16028**	260	210	140	150	2,6	14,5	28	44,5		
130	34750	250	1000	16032**	300	240	160	180	2	17,5	32	68,0		

NOTE / Notes

Designazione / Designation NFR+d - esempio / example: NFR100

Cava / Keyway DIN 6885.1 - Vedi / See pag. 8

1) $C_{max} = 2 \times C_{op}$

*) Con gabbie a rulli a contatto / with plain bearing steel on steel

**) Con 2 cuscinetti a sfere serie 160.. / With 2 ball bearings series 160..

RSBW

Ruote libere a camme per montaggio esterno con cava interna, a tenuta
Sprag type free wheel with inner keyway for external mounting, self-contained

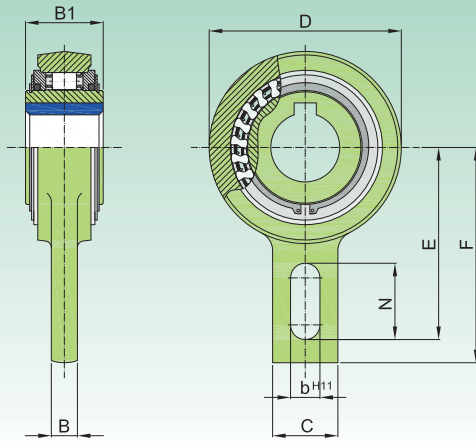

Tipo Type	Misura Size	Dimensioni Dimensions								Coppia massima di funzionamento Maximum operating torque	Velocità limite Overrunning speed	Peso Weight
	d H7	D	B1	F	E	C	N	B	bH11	C op (1)	[RPM]	[kg]
	[mm]	[mm]	[mm]	[mm]	[mm]	[mm]	[mm]	[mm]	[mm]	[Nm]		
RSBW	20	106	35	113	102,5	40	35	15	18	375	400	2
	25	106	48	113	102,5	40	35	15	18	606	400	2,6
	30	106	48	113	102,5	40	35	15	18	606	400	2,5
	35M	106	35	113	102,5	40	35	15	18	375	400	2
	35	106	48	113	102,5	40	35	15	18	606	400	2,4
	40	132	52	125	115	60	35	15	18	1295	300	4,6
	45	132	52	125	115	60	35	15	18	1295	300	4,5
	50	132	52	125	115	60	35	15	18	1295	300	4,5
	55	132	52	125	115	60	35	15	18	1295	300	4,4
	60	161	54	140	130	70	35	15	18	2550	250	6,5
	70	161	54	140	130	70	35	15	18	2550	250	6,4
	80	190	70	165	150	70	45	20	25	4875	200	9,9
90	190	70	165	150	70	45	20	25	4875	200	9,8	

NOTE / Notes

Designazione/Designation RSBW+d - esempio/ example: RSWB80

Cava / Keyway DIN 6885.1 - Vedi / See pag. 8

1) Cmax = 2 × C op

AV

Ruote libere a rulli per montaggio esterno con cava interna, a tenuta
Roller type free wheel with inner keyway for external mounting, self-contained

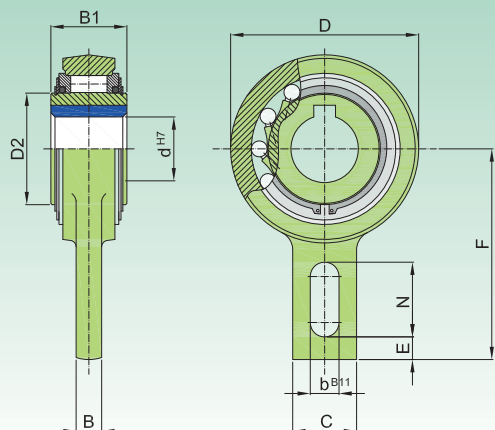

Tipo Type	Misura Size	Dimensioni Dimensions									Coppia massima di funzionamento Maximum operating torque	Velocità limite Overrunning speed	Peso Weight	Coppia di trascinamento Drag torque
	d H7	D	D2	B1	B	C	F	bB11	N	E	C op (1)	[RPM]	[kg]	C dr
	[mm]	[mm]	[mm]	[mm]	[mm]	[mm]	[mm]	[mm]	[mm]	[mm]	[Nm]			[Ncm]
AV	20	83	42	35	12	40	90	15	35	5	265	450	1,3	18
	25	83	42	35	12	40	90	15	35	5	265	450	1,3	18
	30	118	60	54	15	40	110	15	35	8	1200	320	3,5	130
	35	118	60	54	15	40	110	15	35	8	1200	320	3,4	130
	40	118	60	54	15	40	110	15	35	8	1200	320	3,3	130
	45	155	90	54	20	80	140	18	47	10	2150	280	5,5	240
	50	155	90	54	20	80	140	18	47	10	2150	280	5,4	240
	55	155	90	54	20	80	140	18	47	10	2150	280	5,3	240
	60	155	90	54	20	80	140	18	47	10	2150	280	5,2	240
	70	155	90	54	20	80	140	18	47	10	2150	280	5,0	240
	80	190	110	64	20	80	155	20	40	10	2900	200	8,7	360
	90*	260	160	90	25	120	220	-	-	-	7125	150	24,5	360
	100*	260	160	90	25	120	220	-	-	-	7125	150	23,5	360
	110*	260	160	90	25	120	220	-	-	-	7125	150	22,5	360
	120*	300	180	110	30	140	260	-	-	-	11000	130	42	600

NOTE / Notes

Designazione/Designation AV+d - esempio/ example: AV45

Cava / Keyway DIN 6885.1 - **Vedi / See pag. 8**

1) $C_{max} = 2 \times C_{op}$

*) n. 2 cave a 120° / n. 2 Keyways 120° offset

GFR (N)

Ruote libere a rulli con cava interna e fori di fissaggio, autosupportate da cuscinetti
Roller type free wheel with inner keyway and fixing holes, self-supported by ball bearings

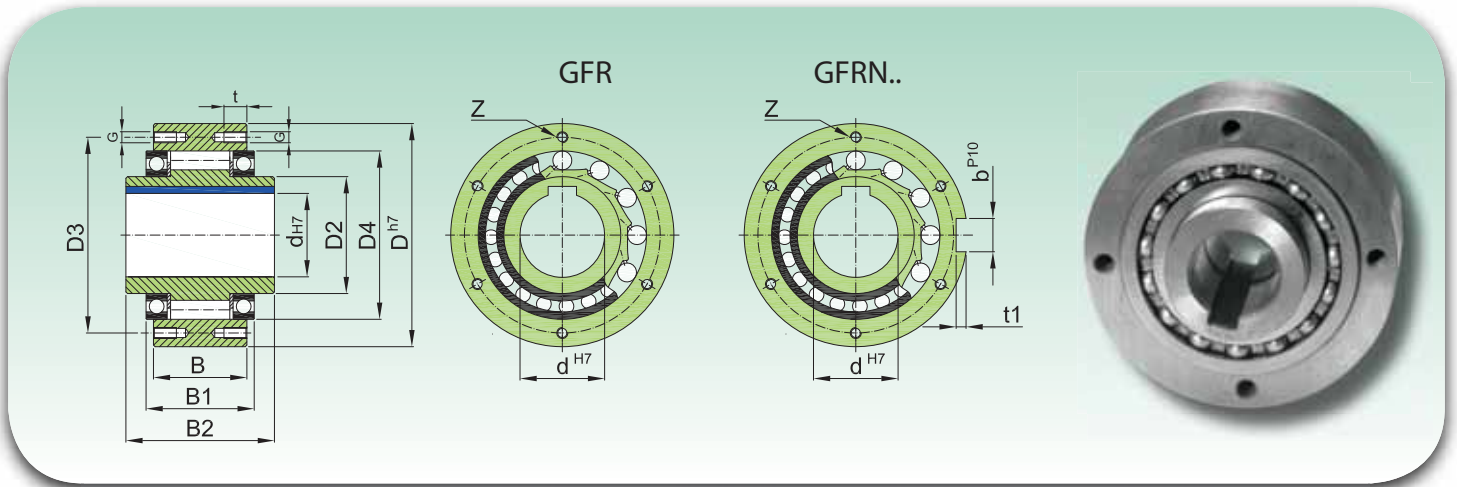

Tipo Type	Misura Size	Coppia massima di funzionamento Maximum operating torque	Velocità limite Overrunning speed of race		Dimensioni Dimensions											Peso Weight	
	d H7	C op (1)	Anello interno Inner ring	Anello esterno Outer ring	Dh7	D2	D4	D3	G	t	z	B	B1	B2	t1		bP10
	[mm]	[Nm]	[RPM]	[RPM]	[mm]	[mm]	[mm]	[mm]	-	[mm]	-	[mm]	[mm]	[mm]	[mm]		[mm]
GFR GFRN	12*	55	4000	7200	62	20	42	51	ø5,5	-	3	20	27	42	2,5	4	0,5
	15	125	3600	6500	68	25	47	56	M5	8	3	28	32	52	3	5	0,8
	20	181	2700	5600	75	30	55	64	M5	8	4	34	39	57	3,5	6	1,0
	25	288	2100	4500	90	40	68	78	M6	10	4	35	40	60	4	8	1,5
	30	500	1700	4100	100	45	75	87	M6	10	6	43	48	68	4	8	2,2
	35	725	1550	3800	110	50	80	96	M6	12	6	45	51	74	5	10	3,0
	40	1025	1150	3400	125	55	90	108	M8	14	6	53	59	86	5	12	4,6
	45	1125	1000	3200	130	60	95	112	M8	14	8	53	59	86	5,5	14	4,7
	50	2125	800	2800	150	70	110	132	M8	14	8	64	72	94	5,5	14	7,2
	55	2625	750	2650	160	75	115	138	M10	16	8	66	72	104	6	16	8,6
	60	3500	650	2450	170	80	125	150	M10	16	10	78	89	114	7	18	10,5
	70	5750	550	2150	190	90	140	165	M10	16	10	95	108	134	7,5	20	13,5
	80	8500	500	1900	210	105	160	185	M10	16	10	100	108	144	9	22	18,2
	90	14500	450	1700	230	120	180	206	M12	20	10	115	125	158	9	25	28,5
	100	20000	350	1450	270	140	210	240	M16	24	10	120	131	182	10	28	42,5
	130	31250	250	1250	310	160	240	278	M16	24	12	152	168	212	11	32	65,0
150	70000	200	980	400	200	310	360	M20	32	12	180	194	246	12	36	138,0	

NOTE / Notes

Designazione/Designation GFR(N)+d - esempio/ example: GFRN55

Cava / Keyway DIN 6885.1 - Vedi / See pag. 8

1) Cmax = 2 × C op

*) GFR12 ha fori passanti / has through holes in outer race

GFR..F1F2F7
GFRN..F5F6

Ruote libere a rulli con cava interna e fori di fissaggio, autosupportate da cuscinetti, a tenuta, con flange da designare.

Roller type free wheel with inner keyway and fixing holes, self-supported by ball bearings, self-contained, with flanges to be designated.

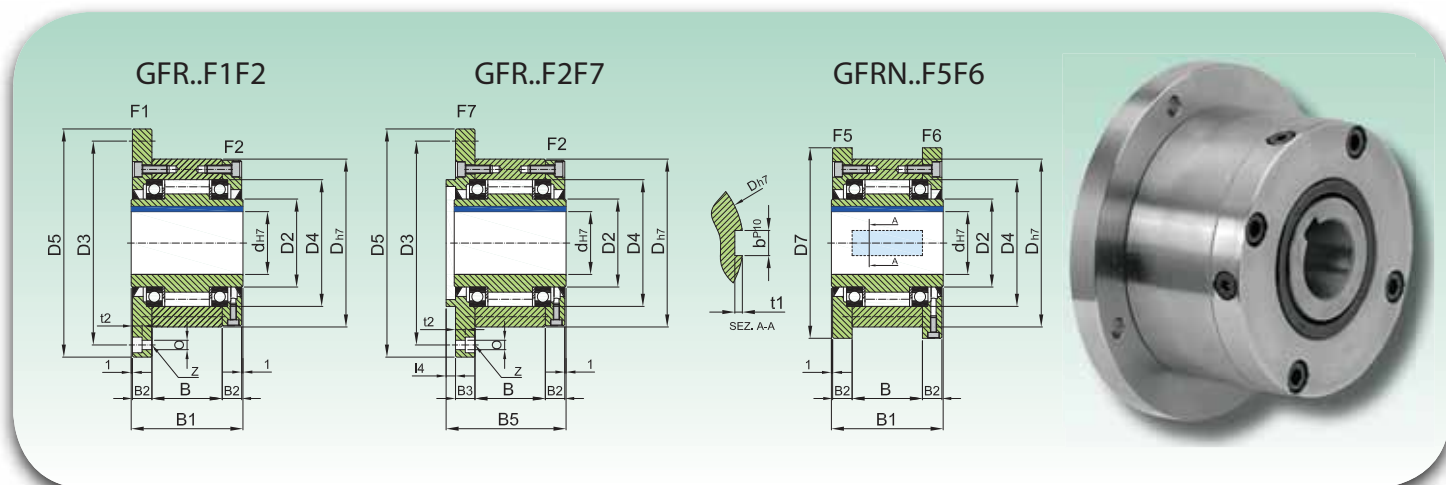

Tipo Type	Misura Size	Coppia massima di funzionamento Maximum operating torque	Velocità limite Overrunning speed of race		Dimensioni Dimensions																Peso Weight
	d H7	C op (1)	Anello interno Inner ring	Anello esterno Outer ring	Dh7	D5	D7	D3	D4h7	0	t2	z	B1	B5	B	B2	B3	l4	t1	bP10	
	[mm]	[Nm]	[RPM]	[RPM]	[mm]						-	[mm]									
"GFR..F1F2, GFR..F2F7, GFRN..F5F6"	12	55	3100	4700	62	85	70	72	42	5,5	5,7	3	42	44	20	10	10	3	2,5	4	1,2
	15	125	2800	4400	68	92	76	78	47	5,5	5,7	3	52	54	28	11	11	3	3	5	1,6
	20	181	2400	4100	75	98	84	85	55	5,5	5,7	4	57	59	34	10,5	10,5	3	3,5	6	1,9
	25	288	1600	3800	90	118	99	104	68	6,6	6,8	4	60	62	35	11,5	11,5	3	4	8	2,9
	30	500	1300	2800	100	128	109	114	75	6,6	6,8	6	68	70	43	11,5	11,5	3	4	8	3,9
	35	725	1200	2600	110	140	119	124	80	6,6	6,8	6	74	76	45	13,5	13	3,5	5	10	4,9
	40	1025	850	2300	125	160	135	142	90	9	9	6	86	88	53	15,5	15	3,5	5	12	7,5
	45	1125	740	2200	130	165	140	146	95	9	9	8	86	88	53	15,5	15	3,5	5,5	14	7,8
	50	2125	580	1950	150	185	160	166	110	9	9	8	94	96	64	14	13	4	5,5	14	10,8
	55	2625	550	1800	160	204	170	182	115	11	11	8	104	106	66	18	17	4	6	16	14,0
	60	3500	530	1700	170	214	182	192	125	11	11	10	114	116	78	17	16	4	7	18	16,8
	70	5750	500	1600	190	234	202	212	140	11	11	10	134	136	95	18,5	17,5	4	7,5	20	20,8
	80	8500	480	1500	210	254	222	232	160	11	11	10	144	146	100	21	20	4	9	22	27,0
	90	14500	450	1300	230	278	242	254	180	14	13	10	158	160	115	20,5	19	4,5	9	25	40,0
	100	20000	350	1100	270	335	282	305	210	18	17,5	10	182	184	120	30	28	5	10	28	67,0
	130	31250	250	900	310	380	322	345	240	18	17,5	12	212	214	152	29	27	5	11	32	94,0
150	70000	200	700	400	485	412	445	310	22	21,5	12	246	248	180	32	30	5	12	36	187,0	

NOTE / Notes

Designazione/Designation GFR(N)+d+(no.Flangia+no.Flangia) - esempio/ example: GFR50F2F7

Cava / Keyway DIN 6885.1 - Vedi / See pag. 8

GFR..F2F3F4

Ruote libere a rulli per montaggio esterno, con cava interna, autosupportate da cuscinetti, a tenuta, con flange da designare.

Roller type free wheel for external mounting, with inner keyway, self-supported by ball bearings, self-contained, with flanges to be designated.

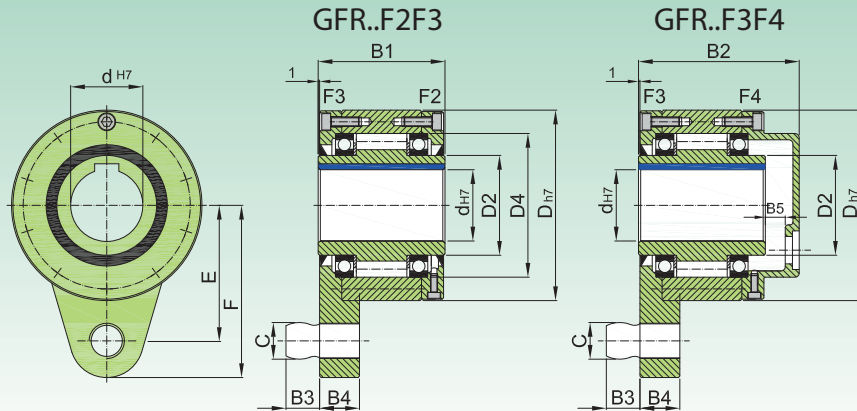

Tipo Type	Misura Size	Coppia massima di funzionamento Maximum operating torque	Velocità limite Overrunning speed	Dimensioni Dimensions										Peso Weight
	d H7	C op (1)		D	D2	C	B1	B2	B3	B4	F	E	B5	
	[mm]	[Nm]	[RPM]	[mm]	[mm]	[mm]	[mm]	[mm]	[mm]	[mm]	[mm]	[mm]	[mm]	[kg]
"GFR..F2-F3 GFR..F3-F4"	12	55	3100	62	20	10	42	64	10	13	59	44	6	1,4
	15	125	2800	68	25	10	52	78	10	13	62	47	10	1,8
	20	181	2400	75	30	12	57	82	11	15	72	54	10	2,3
	25	288	1600	90	40	16	60	85	14	18	84	62	10	3,4
	30	500	1300	100	45	16	68	95	14	18	92	68	10	4,5
	35	725	1200	110	50	20	74	102	18	25	102	76	12	5,6
	40	1025	850	125	55	20	86	115	18	25	112	85	12	8,5
	45	1125	740	130	60	25	86	115	22	25	120	90	12	8,9
	50	2125	580	150	70	25	94	123	22	25	135	102	12	12,8
	55	2625	550	160	75	32	104	138	25	30	142	108	15	16,2
	60	3500	530	170	80	32	114	147	25	30	145	112	15	19,3
	70	5750	500	190	90	38	134	168	30	35	175	135	16	23,5
	80	8500	480	210	105	38	144	178	30	35	185	145	16	32
	90	14500	450	230	120	50	158	192	40	45	205	155	16	47,2
	100	20000	350	270	140	50	182	217	40	45	230	180	16	76
	130	31250	250	310	160	68	212	250	55	60	268	205	18	110
150	70000	200	400	200	68	246	286	55	60	325	255	20	214	

NOTE / Notes

Designazione/Designation GFR(N)+d+(no.Flange+no.Flange) - esempio/ example: GFR70F3F4

Cava / Keyway DIN 6885.1 - Vedi / See pag. 8

Introduzione

Le forniture dei prodotti, presenti in questo documento, sono regolate dalle seguenti condizioni generali di vendita. Sarà necessario un preventivo accordo scritto con il Fornitore per ulteriori ed eventuali clausole e/o condizioni particolari richieste dai Clienti.

Sono da ritenersi inaccettabili, tutte le clausole e/o condizioni contrattuali in contrasto con quanto sotto riportato.

1) Offerte ed ordini

Le offerte mantengono una validità di 30 giorni dalla data di comunicazione al Cliente. Decorso questo termine senza avere ricevuto l'ordine, il Fornitore avrà la facoltà di accettare o non accettare l'ordinazione tardiva. Tutti gli ordini dovranno indicare sempre la tipologia del prodotto, la quantità e la data di consegna richiesta. Il Fornitore si riserva il diritto di fornire eventualmente altri prodotti aventi le stesse caratteristiche merceologiche di quelli ordinati.

Gli ordini sono da intendersi impegnativi per il Cliente, anche senza la forma scritta. Il Fornitore avrà il medesimo obbligo al momento dell'invio della conferma d'ordine (escluse le eccezioni ai punti due e cinque).

2) Prezzi

I prezzi validi di riferimento sono quelli indicati nell'offerta e/o nell'accettazione dell'ordine e sono riferiti solo a prodotti standard. I prezzi relativi a tipologie speciali di prodotto e/o non standard ovvero a richiesta specifica del Cliente, saranno concordati per ogni singolo ordine di volta in volta tra le parti. Il Fornitore si riserva il diritto, per esigenze produttive e/o d'approvvigionamento, di fornire una quantità di prodotto con variazione pari a $\pm 15\%$ rispetto alla quantità concordata con il Cliente. Nel corso delle diverse forniture qualora dovessero verificarsi degli aumenti causati da variazioni quali: aumento delle materie prime, del costo della mano d'opera del costo dei trasporti, delle imposte e dazi, ed anche altri aumenti che comportino aumenti del prodotto per il Fornitore, questo potrà a proprio insindacabile giudizio adeguare i prezzi, comunicando l'entità di tale aumento al Cliente. Le quotazioni dei prodotti, sono da intendersi franco sede del Fornitore, escluso imballo ed IVA.

3) Consegna

La consegna, è da intendersi terminata ed eseguita nel momento in cui i prodotti sono messi a disposizione del Cliente al banco, presso la sede del Fornitore o con la consegna al vettore/spedizionario. Se il Cliente non ha dato precise istruzioni sulle modalità di spedizione dei prodotti o non ha provveduto in modo celere al loro ritiro, il Fornitore potrà conservarli presso i propri locali; a rischio e pericolo ed a spese del Cliente, senza alcuna responsabilità per la loro conservazione o spedirli con mezzi propri o corrieri di propria scelta.

4) Termini di consegna

I termini di consegna indicati dal Fornitore, sono indicativi e non hanno carattere essenziale e perentorio. La loro inosservanza non costituirà in alcun caso motivo di risoluzione del contratto e/o risarcimento d'alcun danno di qualsiasi natura. I termini saranno rispettati per quanto possibile, poiché la consegna dipende da soggetti terzi rispetto al Fornitore. Il Fornitore potrà risolvere il contratto e/o modificare i termini di consegna, senza che ciò possa costituire in alcun modo motivo di risarcimento e/o pagamento d'indennità per eventuali danni subiti dai Clienti, nei seguenti casi:

- I. Inadempienza dei pagamenti e/o pendenze debitorie da parte del Cliente.
 - II. Difficoltà in fase d'approvvigionamento dei prodotti.
 - III. Modifiche alle condizioni contrattuali dopo il ricevimento dell'ordine.
 - IV. Eventi di causa e/o forza maggiore, non imputabili alla volontà del Fornitore, quali a titolo di esempio scioperi di vario genere, calamità naturali, epidemie, sommosse, tumulti, guerre, blocchi doganali che possono gravare sul Fornitore stesso o sulle sue fonti d'approvvigionamento.
 - V. Inesattezze o ritardi da parte del Cliente nella conferma dell'ordine.
- Per i fatti riportati ai punti I-III-V il Fornitore potrà chiedere il risarcimento dei danni al Cliente.

5) Spedizioni

Le spedizioni sono sempre eseguite per conto dei Clienti, pertanto a loro rischio e pericolo, anche nei casi di trasporti "franco destino". Nel caso d'eventuali manomissioni o ammanchi imputabili espressamente al vettore/spedizionario, sarà obbligo del Cliente stesso di presentare reclamo direttamente al vettore/spedizionario. Il Fornitore, potrà accettare reclami per eventuali differenze, qualitative e quantitative dei prodotti, solamente se comunicate da parte del Cliente, in forma scritta entro otto giorni dalla data di ricevimento dei prodotti, a pena di decadenza da ogni e qualsiasi reclamo. In mancanza d'istruzioni dettagliate da parte del Cliente, il Fornitore non sarà responsabile, sia per la scelta dei mezzi di trasporto, sia per le tariffe applicate dai vettori/spedizionieri. Inoltre qualora non sussista accordo tra le parti, le spese di spedizione sono da intendersi a cura ed a carico del Cliente. Nei casi in cui anche solo una parte delle spese di trasporto sia a carico del Fornitore, quest'ultimo potrà servirsi dei mezzi più economici a propria insindacabile scelta. Gli ulteriori aggravii e oneri aggiuntivi nei costi di trasporto saranno ad esclusivo carico del Cliente. Per errori di consegna causati dal Cliente, con conseguente reso dei prodotti, il Fornitore avrà il diritto di addebitare al Cliente le spese di spedizione se dovute, ed il 15% del prezzo dei prodotti.

Introduction

The supply of the products covered by this document is governed by the following general conditions of sale. Any additional clauses and/or special conditions requested by Customers shall only be valid in case of prior written agreement with the Supplier.

All contract clauses and/or conditions in conflict with the terms set out below shall be considered unacceptable.

1) Offers and orders

Offers are valid for 30 days from the date of communication to the Customer. If no order is received within this period, the Supplier shall have the option of accepting or rejecting late orders, at its own discretion. All orders must always state the type of product, the quantity and the delivery date required. The Supplier reserves the right to supply different products with the same characteristics as those ordered.

Orders are binding on the Customer even if not in writing. Orders shall also be binding on the Supplier once the confirmation of order has been dispatched (with the exceptions in points two and five below).

2) Prices

The valid reference prices are those stated in the offer and/or the order acceptance, and refer to standard products only. The prices relating to special and/or nonstandard product types, or to specific requests from the Customer, shall be agreed between the parties for each order on a one-off basis.

Depending on production and/or procurement requirements, the Supplier reserves the right to supply a quantity of product with variation of $\pm 15\%$ from the quantity agreed with the Customer. Over a series of shipments, if increases occur due to variations such as increases in raw material costs, in the cost of labour, freight costs, taxes and duties, or any other increases which lead to increases in the cost of the product for the Supplier, the latter may adjust the prices accordingly, at its own absolute discretion, informing the Customer of the amount of any such increase. Quotations for products are ex-works Supplier's factory, not including packaging or VAT.

3) Delivery

Delivery is considered to have taken place when the products are placed on the Customer's disposal on the counter on the Supplier's premises, or on consignment to the carrier/ forwarding agent. If the Customer has not given clear instructions concerning the procedures for shipment of the products, or has not arranged for their prompt collection, the Supplier may store them on its own premises, at the Customer's risk and expense, without any responsibility for their conservation, or may ship them using its own vehicles or carriers of its choice.

4) Delivery terms

The delivery terms stated by the Supplier are guideline and not binding. In no case shall failure to meet them constitute grounds for termination of the contract and/or for compensation for any damage of any kind. Delivery terms shall be complied with as far as possible, since delivery depends on third parties over which the Supplier has no control. The Supplier may terminate the contract and/or modify the delivery terms, without this constituting grounds for compensation and/or payment of damages for any costs or losses incurred by the Customer, in the following cases:

- I. Failure to meet payment terms and/or outstanding debts on the part of the Customer.
 - II. Difficulty in procurement of the products.
 - III. Modifications of the contract conditions after receipt of the order.
 - IV. Circumstances of force majeure, beyond the Supplier's control, such as, for example, strikes of various kinds, natural disasters, epidemics, uprisings, riots, wars or customs blockades which may affect the Supplier itself or its sources of supply.
 - V. Inaccuracies or delays on the part of the Customer in confirming the order.
- In the circumstances listed in points I-III-V, the Supplier may request compensation from the Customer.

5) Shipments

Shipments are always made on the Customer's behalf and therefore at its risk, even in case of delivery "freight prepaid". In case of tampering or missing items for which the carrier/forwarding agent is specifically to blame, the Customer shall be responsible for placing a claim directly with the carrier/forwarding agent. The Supplier will only be able to accept claims for any differences in the quality or quantity of the products if submitted by the Customer, in writing within eight days after the date of receipt of the products; otherwise, all claims shall become null and void. In the absence of detailed instructions from the Customer, the Supplier shall not be responsible for the choice of means of transport or for the rates charged by the carriers/forwarding agents. Moreover, in the absence of agreement between the parties, the shipment expenses shall be payable by the Customer. If even just a part of the freight costs is to be met by the Supplier, the latter shall be permitted to make use of the most economical means of transport, at its own absolute discretion. Any additional freight costs and/or charges shall be solely for the Customer's account. For errors in delivery caused by the Customer which result in return of the products, the Supplier shall be entitled to charge the Customer the shipment expenses, if due, plus 15% of the price of the products.

6) Pagamenti

Il Cliente non potrà sospendere ovvero ritardare i pagamenti della merce per nessun motivo e dovranno essere eseguiti al domicilio del Fornitore, come indicato nei documenti che accompagnano la spedizione dei prodotti.

Non saranno considerati validi pagamenti effettuati in luoghi diversi, salvo che non siano stati concordati preventivamente con il Fornitore.

Decorsi i termini indicati, il Fornitore avrà diritto al pagamento, oltre alla somma capitale dovuta per il prezzo della merce, anche agli interessi di mora pari all'Euribor aumentato del 3%, avvalendosi del diritto d'agire anche giudizialmente nei confronti del Cliente moroso.

Il Fornitore ha la facoltà di sospendere temporaneamente la fabbricazione o la fornitura dei prodotti ancora in ordine; inoltre potrà annullare il residuo dell'ordine stesso, comunicandolo al Cliente, che non avrà diritto ad indennizzi d'alcun genere.

Il Fornitore avrà il diritto di ottenere il pagamento delle somme dovute per le consegne già eseguite. Per ogni contestazione inerente a prodotti in corso di fabbricazione, pronti per essere spediti o già in possesso del Cliente, quest'ultimo non è liberato dai propri obblighi e dovrà provvedere al pagamento, alla data stabilita, di quanto dovuto al Fornitore.

7) Garanzia

La garanzia s'estende per un anno dalla data di consegna dei prodotti; è limitata esclusivamente alla riparazione o alla sostituzione gratuita dei pezzi riconosciuti non conformi rispetto alle specifiche riportate sui cataloghi tecnici.

La responsabilità della garanzia del Fornitore decade per tutti i prodotti che hanno subito manomissioni, sovraccarichi d'esercizio, lubrificazioni, riparazioni errate o errori in fase di montaggio, quindi per problemi causati da un utilizzo improprio del Cliente e pertanto non più restituibili al Fornitore.

Il Cliente inoltre è tenuto ad avvertire il Fornitore per eventuali difetti, vizi o non conformità dei prodotti entro otto giorni dal ricevimento degli stessi (in forma scritta), pena la decadenza della garanzia. Non saranno accettati reclami trascorsi i termini sopra citati.

I reclami non possono causare l'annullamento o la riduzione degli ordini da parte del Cliente, né la corresponsione d'indennizzi e/o risarcimenti da parte del Fornitore. Non si accettano ritorni di prodotti, se non preventivamente autorizzati. Non si accettano ritorni di forniture, per prodotti resi non integri o manomessi o espressamente costruiti, lavorati e/o modificati per il Cliente. Il materiale non conforme dovrà essere reso previa autorizzazione del Fornitore, esente da ogni spesa (franco destino).

Sul documento di reso dovranno essere riportati gli estremi del DDT o fattura di vendita relativa (Data e n° - obbligatorio per legge). Il Fornitore non assume alcuna responsabilità per incidenti che possano avvenire nell'utilizzo dei propri prodotti.

8) Offerte ed ordini

Il Fornitore qualora accetti commesse di prodotti speciali o su particolari specifiche tecniche del Cliente, dovrà sempre ricevere un disegno tecnico dettagliato prima di procedere alla produzione. Dopo aver accettato l'ordine e previa consegna del disegno tecnico, il Fornitore invierà al Cliente una campionatura del prodotto. Il Cliente, dopo averne preso visione, dovrà inviare conferma scritta al Fornitore per l'esecuzione dell'intera fornitura. Nel caso in cui il Cliente per motivi non imputabili al Fornitore rifiutasse in modo parziale o completo la fornitura, il Fornitore potrà avvalersi del diritto di addebitare le spese per l'esecuzione della campionatura, oltre al mancato guadagno e per gli eventuali danni subiti, trattandosi di prodotti non commercializzabili. Il Fornitore provvederà al ritiro ed alla sostituzione del materiale non conforme, nel caso in cui il Cliente dimostrasse palesemente che le caratteristiche del prodotto fornito non corrispondono a quelle dei campioni consegnati, senza alcuna responsabilità da parte del Fornitore e con rinuncia del Cliente ad ogni richiesta di risarcimento a qualsiasi titolo richiesto.

9) Materiali

I materiali utilizzati per la costruzione dei prodotti contenuti nel presente catalogo possono essere soggetti ad aggiornamenti solo ed esclusivamente migliorativi all'interno della loro categoria di appartenenza.

Il Cliente non potrà perciò avvalersi di questa caratteristica per eventuali reclami al Fornitore.

10) Validità e deroghe delle Condizioni Generali di Vendita

Ogni e qualsiasi deroga o modifica alle sopra indicate condizioni generali di vendita, dovrà essere convenuta in forma scritta tra le parti.

11) Domicilio del Cliente

Il domicilio del Cliente è da intendersi quello ove il Cliente ha la propria sede legale, salvo diversa comunicazione scritta. Il Fornitore pertanto indirizzerà tutte le comunicazioni e le spedizioni dei prodotti in quella sede.

12) Foro competente

Per ogni e qualsiasi controversia sarà competente il foro dove si trova la sede legale del Fornitore.

6) Payment

The Customer shall not be permitted to suspend or delay payments for goods for any reason, and payments must be made to the Supplier's domicile, as stated in the documents which accompany the shipment of the products. Payments made to other places shall not be considered valid unless agreed in advance with the Supplier.

Once the specified payment terms have passed, the Supplier shall be entitled to payment, not only of the capital sum due for the price of the goods, but also of interest at the Euribor rate increased by 3%, and retains the right to take legal action against any Customer late with payments.

The Supplier shall be entitled to temporarily suspend the manufacture or supply of any products still on order; it may also cancel the remainder of the order, informing the Customer, which shall not be entitled to compensation of any kind. The Supplier shall be entitled to obtain payment of the sums due to it for the deliveries already made. In case of any disputes concerning products being manufactured, ready for shipment or already in the Customer's possession, the latter shall not be released from its obligations and must pay the amounts due to the Supplier at the date set.

7) Warranty

The warranty is valid for one year from the date of delivery of the products; it is limited solely to the repair or replacement, free of charge, of pieces acknowledged not to comply with the specifications stated in the technical catalogues.

The Supplier's warranty ceases to apply to all products which have been tampered with, operated with overloads, improperly lubricated or repaired, or incorrectly assembled; in other words, for all problems caused by improper use by the Customer, for which the Supplier is not responsible.

The Customer is also obliged to inform the Supplier about any defects, faults or nonconformity of the products within eight days after the date of receipt of the same (in writing); otherwise, the warranty shall become null and void. No claims shall be accepted once the above terms have expired.

Claims shall not constitute grounds for the cancellation or reduction of orders on the part of the Customer, or the payment of damages and/or compensation on the part of the Supplier. No returns of products are accepted unless authorised in advance.

No returns are accepted of products which are not intact, have been tampered with, or have been specifically built, processed and/or modified for the Customer. Nonconforming material must be returned, further to the Supplier's authorisation, with all expenses paid (freight prepaid). The return document must contain the details of the original transport document or invoice (date and number - compulsory by law). The Supplier does not accept any responsibility for accidents occurring during the use of its products.

8) Special and/or custom-made products

If the Supplier accepts orders for special products or those made to the Customer's own technical specifications, it must always receive a detailed technical drawing before proceeding with production. After accepting the order and further to consignment of the technical drawing, the Supplier shall send the Customer a sample lot of the product. After viewing the sample lot, the Customer shall send the Supplier written confirmation for production of the entire ordered amount. If, due to circumstances beyond the Supplier's control, the Customer refuses delivery of all or part of the goods, the Supplier shall be entitled to reimbursement of the expenses for production of the sample lot, and for compensation for loss of earnings and for any damages incurred, since these products are not marketable.

The Supplier shall collect and replace non-conforming material if the Customer clearly demonstrates that the characteristics of the product supplied differ from those of the samples consigned, without any liability on the part of the Supplier and with waiver on the part of the Customer of any request for compensation on any grounds.

9) Materials

The materials used to manufacture the products featured in this catalogue may be updated exclusively for improvement purposes within their range, therefore the Customer is not entitled to have recourse to these upgrades to lodge any claim with the Supplier.

10) Validity and waivers of the General Conditions of Sale

Any waivers or modifications of the aforesaid general conditions of sale must be agreed between the parties in writing.

11) Customer's Domicile

The Customer shall be domiciled in the place where it has its registered office, unless otherwise notified in writing. The Supplier shall therefore send all communications and shipments of products to the relevant address.

12) Legal jurisdiction

The law court of the Supplier's registered office shall have jurisdiction over all disputes of any kind.

NBS®

©Copyright NBS®

È vietata la riproduzione anche parziale del contenuto di questo Catalogo Tecnico. Non si possono accettare responsabilità per eventuali errori od omissioni. Le misure non sono impegnative. Marchio registrato Italia-EU.

The reproduction, even partial, of the contained concerning this Technical Catalogue, is forbidden. Liability for possible errors and/or omissions are not accepted. Sizes are not binding.
™ Registered in Italy-EU.



Politica ambientale

Il presente **Catalogo Tecnico NBS®** è stato realizzato con **materiale ecologico certificato FSC**. Il processo produttivo della carta avviene attenendosi alle vigenti normative: **DS/EN ISO 14001** e **ISO 9001:2000**. La plastificazione della copertina è avvenuta utilizzando materiale biodegradabile; gli inchiostri per la stampa sono a base vegetale. Per cortesia, continuate nel Vostro impegno costante per la salvaguardia dell'ambiente.

Environmental policy

This NBS® Technical Catalogue has been produced with 100% ecological material certified FSC. Manufacturing process follows the regulations in force: DS/EN ISO 14001 and ISO 9001:2000. Plasticization of the cover page has been achieved using biodegradable materials, inks used are vegetable based. Please continue your actions in order to protect the environment and recycle properly.

NBS[®]

RUOTE LIBERE
FREE WHEELS

1.2.12 ©Copyright



79991004



MISTO
Carta da fonti gestite
in maniera responsabile
FSC® C101645