



Barden Super Precision Ball Bearings

Speciality Products

Table of Contents



Capabilities

Committed to Excellence.....	4
Global Reach	4
Barden's Products	5
Precision Standards.....	5
Beyond ABEC.....	6
Sizes and Configurations.....	6
Applications	7
Quality Management	8
Product Engineering	9

Bearing Types

Deep Groove Bearings	10
Angular Contact Bearings	11

Nomenclature

Product Tables

Deep Groove Instrument (Inch)	14 – 17
Deep Groove Instrument (Metric)	18 – 19
Deep Groove Flanged (Inch)	20 – 21
Deep Groove Thin Section (Inch)	22 – 25
Thin Section (Inch).....	26 – 27
Deep Groove Spindle and Turbine..... (Metric)	28 – 33
Angular Contact (Inch)	34 – 35
Angular Contact (Metric)	36 – 41

Special Applications

Introduction & Capabilities	43
Vacuum Pumps.....	44
Emergency Touchdown/Auxiliary Bearings.....	45
Medical and Dental - High Speed	46 – 47
Dental Handpiece Bearings	
Medical and Dental - X-Ray	48 – 49
Aviation and Defense – Auxiliary	50 – 51
Equipment	
Aviation and Defense –	52 – 53
Instrumentation and Sensing	
Aviation and Defense – Actuation	54 – 55
Systems	
Canning Industry	56
Nuclear Power	57
Emerging Automotive Technologies	58 – 59
Thrust Washers.....	60

Engineering

Bearing Selection

Selecting the Right Bearing	64
Operating Conditions.....	64
Bearing Types	65
Diameter Series.....	66
Sizes and Materials	66
Ball & Ring Materials	66 – 67
Ceramic Hybrid Bearings	68 – 70
X-life Ultra Bearings	70
Surface Engineering Technology	71 – 72

Bearing Application

Solid Lubrication	72
Bearing Cages	73 – 77
Bearing Closures	78 – 79
Attainable Speeds & Limiting Speed Factors..	80
Internal Design Parameters.....	81
Ball Complement	81
Raceway Curvature	81
Radial Internal Clearance	81 – 83
Contact Angle	84 – 85
Axial Play.....	86 – 87
Ball Complement (Tables)	88 – 90
Preloading.....	91 – 95
Lubrication	96 – 103
Tolerances and Geometric Accuracy ...	104 – 105
Tolerance Tables	106 – 109

Bearing Performance

Bearing Life	110
Service Life.....	110
Bearing Capacity.....	110 – 111
Fatigue Life.....	112 – 115
Grease Life	116
Vibration	117
Yield Stiffness.....	118
Torque	118
Measurement and Testing.....	118 – 119

Mounting and Fitting	120
Shaft & Housing Fits.....	121
Fitting Practice.....	121
Fitting Notes	122 – 123
Shaft & Housing Size Determination ..	123 – 124
Maximum Fillet Radii	124
Shaft & Housing Shoulder Diameters.....	125
Abutment Tables.....	126 – 134
Random and Selective Fitting.....	135
Calibration.....	135 – 136
Maintaining Bearing Cleanliness.....	137 – 138
Handling Guidelines	139
Index	140

Capabilities

Precision with Vision

Committed to Excellence

The Barden Corporation is recognized as a world leader in the design and manufacture of super precision ball bearings. For more than six decades the Barden name has been synonymous with bearings of exceptional quality and precision and Barden bearings are renowned worldwide for their high reliability and long operating life in challenging applications.

Barden offers thousands of bearing variations which are used in virtually every sector of industry where there is the need to meet critical tolerances, high speeds and performance under demanding operating conditions. These include key components for the aerospace and defense sectors, vacuum pumps, food processing, robotics and medical equipment, including x-ray and CAT scanners and high speed dental handpiece turbines.

Barden's success has been built on a solid foundation of manufacturing and engineering design expertise, a highly skilled workforce and the ability to design bespoke engineered solutions for its customers.



Global Reach

Originally founded in 1942 by Theodore Barth and Carl Norden in the United States, The Barden Corporation has built an enviable reputation for producing some of the world's most precise bearings and is now a key strategic member of the multinational Schaeffler Group. The Group specializes in bearing technologies and precision products for aerospace, industrial plant and automotive industries and has over 74,000 employees at more than 180 locations worldwide.

The Barden Corporation boasts state-of-the-art facilities at its manufacturing plants in Danbury, USA and Plymouth, UK, both of which have some of the world's most sophisticated machine tools, production equipment and inspection systems installed. As a supplier to some of the most prolific blue chip companies across the globe, quality is of the utmost importance throughout the organization. Stringent standards are applied to every element of the business, from the customer interface and design, through to production, packaging and delivery.

Barden's Products

The Barden product line is comprised largely of radial, single and double row, angular contact (separable and non-separable) and deep groove, super precision ball bearings. All products in the range can meet and will usually exceed ABEC 9 (ISO P2) standards, while full traceability back to raw materials can also be provided.

Barden's product offering also includes large and small diameter thin section ball bearings. Produced in standard cross sections and configurations, these bearings can be customised to meet the unique needs of each application.



Barden super precision bearings come in inch or metric dimensions with diameters ranging from 4mm ($5/32$ " OD) up to 300mm ($11\frac{1}{2}$ " OD). A variety of seals, shields and metallic/non-metallic cage designs are available to meet most requirements. Many Barden bearings operate comfortably at speeds reaching 2 million dN (bore in mm x RPM), or above.

Precision Standards

Precision ball bearings are manufactured to tolerance standards defined by the Annular Bearing Engineering Committee (ABEC) of the American Bearing Manufacturers Association (ABMA). These standards are accepted by the American National Standards Institute (ANSI) and can be seen as broadly equivalent standards for the International Organization for Standardization (ISO).

ABEC Standard	ISO Standard	M&I ABEC Standard	M&I ISO Standard
1	P0		
3	P6	3P	P6
5	P5	5P	P5A
7	P4	7P	P4A
9	P2	9P	P2

ABEC standards define tolerances for several major bearing dimensions and characteristics, which are divided into envelope dimensions (bore, OD and width) and bearing geometry. Bores and OD's may be calibrated for greater mounting flexibility.

Barden encompasses specialist product lines, including large and small diameter thin section bearings, dental bearings, spindle and turbine bearings, turbomolecular pump and machine tool bearings. While general purpose bearings for these ranges are manufactured to ABEC 1 through to ABEC 9 standards commercially, Barden bearings of these types meet or exceed ABEC 7 geometric standards. Additionally, Barden's 'miniature and instrument' product range is produced in equivalent classes with added refinements designated by suffixes, and are comparable to ABEC 7 or above.



Capabilities

Precision with Vision

Beyond ABEC

ABEC classes are primarily concerned with bearing tolerances and while very helpful in categorizing precision, there are many other factors that affect the suitability of a bearing to its application.

Total bearing quality and 'fitness for purpose' in critical applications is of major importance and Barden often maintains closer tolerances than specified. There are several factors affecting bearing performance and life which are not covered by ABEC standards and these are addressed during the design and manufacture of all Barden bearings.

For example, ABEC criteria does not include functional testing of assembled bearings, yet this measure can be extremely important. Barden applies self-established standards, using proprietary tests and measuring equipment to ensure the delivery of quiet, smooth-running bearings that will perform exceptionally well.

Bearing design is also omitted from ABEC classification but can make the difference between success and failure in bearing use. Barden offers a flexible and innovative design service for this purpose, which takes into account all the factors likely to impact on an application. As such, a Barden bearing may have specific low torque characteristics for a gyro gimbal, extra stiffness for a textile spindle, or extremely high reliability for an aerospace accessory application. Because ball quality affects the running smoothness of a bearing, Barden uses both steel and ceramic balls produced to its own exacting specifications for ball geometry, finish and size control.

Sizes

Barden's super precision bearings are available in metric or inch dimensions, with diameters ranging from 1.5mm (0.06") bore diameter to 300mm (11½") OD, and can be categorized as either 'miniature and instrument' or 'spindle and turbine'. This categorization is primarily related to size, however the application can sometimes be used to classify the bearing.

Configurations

Barden manufactures deep groove and angular contact (separable and non-separable) bearings, available with a wide variety of seals, shields, speciality lubricants, metallic and non-metallic cage designs and calibration options. Thanks to an innovative design service, Barden products can incorporate bespoke design features, such as direct lubricant injection slots, fixings and flanges. Flanged bearings are especially useful in through-bored housings. The inboard side of the flange provides an accurate positioning surface for bearing alignment, eliminating a need for housing shoulders or shoulder rings.

Barden products are available in a range of materials to suit all applications, including SAE 52100 carbon chrome steel, AISI 440C, AISI M50 and Cronidur 30®, a high nitrogen steel originally developed for critical aerospace applications

Design innovation has led to the development of extra wide, or cartridge width, deep groove bearings which are available in Series 9000 for applications requiring extended operation without lubrication. These bearings offer more interior free volume and can therefore hold more grease. Furthermore, improved lubricant life in extreme or hostile environments and increased speedability can be offered through the use of ceramic balls. The benefits of hybrid bearings over traditional steel ball bearings are well known and all Barden products can be fitted with ceramic balls.

Applications

Complementing Barden's range of standard products are a range of re-engineered, modified and custom-designed bearings, created to customer specifications. Often designed around a particular application, these 'special' bearings offer users something new in terms of precision, size or configuration. Examples of Barden bearing applications include:

- **VACUUM PUMPS.**
 - **TURBOMOLECULAR PUMPS.**
 - **DRY PUMPS.**
- **TOUCHDOWN BEARINGS.**
- **MEDICAL.**
 - **DENTAL HANDPIECE TURBINES.**
 - **X-RAY TUBES.**
- **AVIATION & DEFENSE.**
 - **AUXILIARY EQUIPMENT.**
 - **INSTRUMENTATION & SENSING.**
 - **ACTUATION SYSTEMS.**
- **NUCLEAR POWER.**
- **EMERGING AUTOMOTIVE TECHNOLOGIES.**
- **CANNING INDUSTRY.**



Vacuum pumps place severe demands on precision bearings, which must operate reliably under extreme conditions and meet long life requirements



The precision bearings in CAT scanner x-ray tubes use a special Barden bearing design which must operate in a vacuum under boundary lubrication conditions



Barden bearings are an integral part of dental drill design, where high speeds, reliable performance and low maintenance are critical



Commercial aviation applications include a wide variety of aircraft accessories and critical components, and comprise a large percentage of Barden's core business



The Barden super precision bearings used in the International Space Station must meet stringent performance requirements with minimal lubrication

Capabilities

Quality Management

Barden's Quality Management Systems are accredited to Aerospace Standard AS9100. In addition, we are able to satisfy specific customer requirements such as The National Aerospace and Defense Contractors Accreditation Program (NADCAP) for our heat treatment and non-destructive testing processes; and to satisfy regulatory requirements imposed by the Federal Aviation Administration (FAA) and European Aviation Safety Agency (EASA). These controls are coupled with a planned flexibility which enables Barden to comply with specific requirements of individual customers through a system of bespoke quality levels and formal certification of our products.

Quality is fundamental to all Barden products and services. Our philosophy of "zero defects" is applied to every aspect of our business; from customer service, through design and procurement; and onto manufacturing, assembly and post-delivery support. We place strong emphasis on "quality planning" using preventive tools such as Failure Mode and Effects Analysis (FMEA) for our design and manufacturing processes.

Our Quality and Manufacturing Engineering staff determine and monitor the capabilities of our measurement systems and production machines respectively; thereby ensuring that manufacturing tolerances can be achieved. In-process machine control is facilitated using pre-control; and these statistical methods are employed as production tools to gain better and more consistent quality. We also provide continual investment in business improvement techniques such as Six-Sigma and lean manufacturing at both local and corporate levels.

Each lot of parts or assembled bearings must conform to defined quality requirements before being allowed to move to the next operation. Barden's operators are certified through vigorous training and auditing to perform inspection operations during the manufacturing process.

Similarly, our "Approved Supplier" programme ensures that our suppliers are also in line with our expectations, consistently supplying us with quality products.



The Metrology Department of Barden's quality control organization provides basic standards of reference, using many advanced types of instrumentation. All linear measurements are certified and traceable back to National Standards. Similarly, our Metallurgical and Chemical Laboratories provide routine verification of incoming bearing steel, lubricants, cage material and other supplies. These laboratories work closely with external providers, universities and establishments to ensure continual development of our products and processes.

All these aspects are echoed in Barden's Quality Management principles of continual improvement; zero defects and customer satisfaction.

Product Engineering

Barden Product Engineering services are available to all customers and prospective users of Barden products. Our engineers and technicians have capabilities in every area of bearing design, application, testing and development. When bearing performance involving torque, vibration or stiffness is an issue, they can perform computer analysis of characteristics and requirements in order to determine a suitable bearing design.

If standard catalogue bearings lack the necessary characteristics for a particular application, our Product Engineering Department can design a special bearing to meet your requirement, whether this is a change of material for extreme environments, changes to the internal design or modified interface dimensions.

With over 60 years of specialization in the field of precision ball bearings, Barden engineers can draw upon a wealth of technical information to aid in failure analysis or troubleshooting of performance problems. They can readily identify the contributing causes and recommend solutions to improve bearing performance or useful life. As part of the

Schaeffler Group, Barden can also draw on the additional global experience of Schaeffler's R&D functions.

Our Product Development Laboratories conduct investigations into new materials, coatings, lubricants and bearing designs. These laboratories are the center for Barden's work on unusual bearing problems, special environmental testing and vibration analysis. Endurance and reliability testing is also performed here.

If you have a particular problem that you would like Barden's engineers to review, please contact your local Schaeffler sales company or an Authorized Barden Distributor.

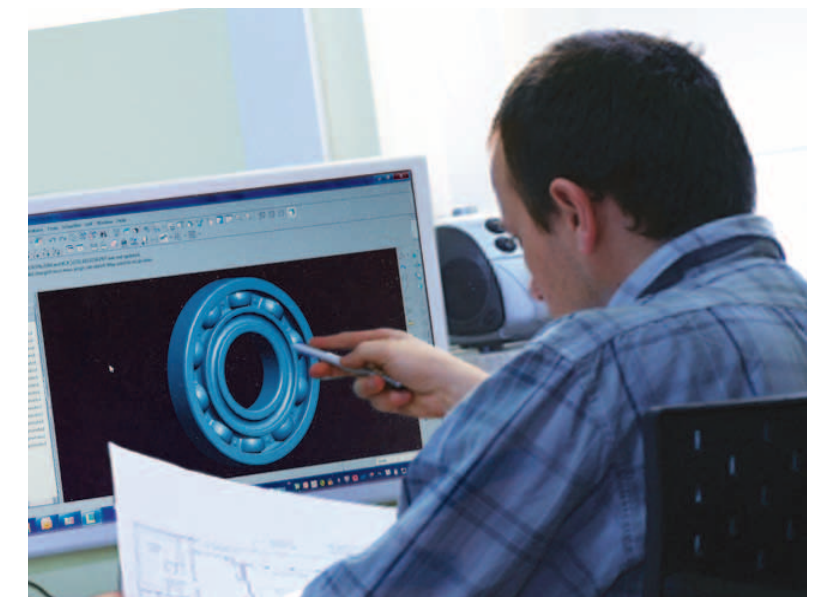

Bearing Types



Deep Groove Bearings

Deep groove ball bearings have full shoulders on both sides of the raceways of the inner and outer rings. They can accept radial loads, thrust loads in either direction, or a combination of loads.

The full shoulders and the cages used in deep groove bearings make them suitable for the addition of closures. Besides single deep groove bearings with closures, Barden also offers duplex pairs with seals or shields on the outboard faces.

Deep groove bearings are available in many sizes, with a variety of cage types. Their versatility makes them the most widely used type.

Ceramic (silicon nitride) balls can be specified to increase bearing stiffness, reduce vibration levels and prolong life.

Deep groove bearings can also be supplied with a full complement of balls as a filler notch design. In filler notch bearings the inner and outer ring have notches which when aligned, allow balls to be loaded directly in to the raceway. Whilst this allows for full complement, these bearings are typically suited to radial loads.



Flanged bearings provide solid mounting for good axial control and eliminate the need for housing shoulders or shoulder rings. Housings can be through-bored to reduce manufacturing costs and simplify assembly. When flanged bearings are used, the housing mounting surfaces must be accurately machined to properly position and support the bearings.

Flanged bearings are recommended when housing designs cannot accommodate full bearing width, or where the quality of the housing bore is a concern.



H type

Non-Separable Type (H): Inner ring has full shoulders, outer has one shoulder cut away with a small retaining lip at the edge of the raceway.



J type

Non-Separable Type (J): Outer ring has full shoulders, inner ring has one shoulder cut away with a small retaining lip at the edge of the raceway.



B type

Separable Type (B): Outer ring has full shoulders, inner ring has one shoulder cut away. The inner ring is removable for mounting on the shaft separately from the outer ring assembly.

Angular Contact Bearings

Angular contact bearings have one ring shoulder removed, either from the inner or outer ring. This allows a larger ball complement than found in comparable deep groove bearings, giving a greater load capacity. Speed capacity of angular contact bearings is also greater.

Barden angular contact bearings have a nominal contact angle ranging from 10° to 25°. They can be used in pre-loaded duplex sets, back to back (DB) or face to face (DF) for supporting thrust loads in both directions or in tandem (DT) for additional capacity.

Contact angles are obtained by assembling the bearings to the appropriate radial play values. The smaller contact angles give better radial capacity and rigidity while the higher contact angles give higher axial capacity and rigidity.

Angular contact bearings support thrust loads or combinations of radial and thrust loading. They can not accept radial loads alone – a thrust load of sufficient magnitude must be applied.

A single angular contact bearing can be loaded in one thrust direction only, this may be an operating load or pre-load.

Separable and non-separable types are available. Separable bearings are useful where bearings must be installed in blind holes or where press fits are required on the shaft and in the housing. The separable feature also permits dynamic balancing of the rotating components with the inner ring mounted in place without the outer ring and housing.

As with deep groove bearings, angular contact bearings can also be supplied with a full complement of balls and no retainer. Full complement angular contact bearings are designated by 'X205' in the nomenclature and are typically suited to axially loaded applications.

Nomenclature

EXAMPLES

1. Material Special processes	2. Series and Size Type	3. Bearing Type	4. Closures	5. Cages	6. Special Features	7. Radial Play	8. Bore + OD Tolerance Functional Test	9. Duplexing	10. Radial Runout	11. Calibration	12. Lubrication
S	R4		SS	W	X8	K5	VK			C	O-11
	R2	H						DB5	E		G-2
C30X	104		FF	T		3			E		G-33
	38	H						DL	R2		O-49
<p>S AISI 440C rings and balls</p> <p>C Ceramic balls</p> <p>30X X-Life Ultra Rings</p> <p>M AISI M50 rings and balls</p> <p>A AISI 440C rings and balls (500 Series)</p> <p>BC Barrier coating</p> <p>P TCP coating of rings and balls</p> <p>V Denotes ABEC 5T for torque tube and extra thin series</p> <p>No symbol indicates SAE 52100 rings and balls</p> <p>Other materials are available on request</p> <p>Pages 66 – 67</p>	<p>R Inch series instrument</p> <p>R100 Inch series miniature</p> <p>R1000 Inch series extra thin</p> <p>00M00 Metric series instrument</p> <p>500 Inch series torque tube</p> <p>N500 Inch series torque tube - narrow width</p> <p>30 Metric series spindle and turbine</p> <p>100 Metric series spindle and turbine</p> <p>200 Metric series spindle and turbine</p> <p>300 Metric series spindle and turbine</p> <p>1900 Metric series spindle and turbine</p> <p>9000 Metric series S&T cartridge width</p> <p>FR Inch series instrument flanged</p> <p>FR100 Inch series miniature flanged</p> <p>RW Wide inner ring, instrument</p> <p>RW100 Wide inner ring, miniature</p> <p>Special bearings</p> <p>Z Special bearing</p> <p>SCB Special customer bearing</p> <p>See product tables, pages 14 – 41</p>	<p>Deep Groove</p> <p>(None) Deep groove</p> <p>Angular Contact</p> <p>B Separable, relieved inner ring</p> <p>E Separable, relieved outer ring</p> <p>H Non-separable, relieved outer ring</p> <p>J Non-separable, relieved inner ring</p> <p>Pages 10 – 11</p>	<p>Deep Groove</p> <p>S Single shield</p> <p>SS Double shield</p> <p>A Single non-contact Barshield</p> <p>AA Double non-contact Barshield</p> <p>F Single Flexeal</p> <p>FF Double Flexeal</p> <p>U Single Synchro Seal</p> <p>UU Double Synchro Seal</p> <p>Y Single Barseal</p> <p>YY Double Barseal</p> <p>VV Double Viton Barseal</p> <p>PP Double Polyacrylic Barseal</p> <p>RS Single shield fitted into plain side of flanged bearing</p> <p>No symbol indicates an open bearing</p> <p>Angular contact</p> <p>Consult Barden Product Engineering Dept.</p> <p>Pages 78 – 79</p>	<p>Deep Groove</p> <p>W Stainless steel 2 piece ribbon loosely clinched</p> <p>TA Reinforced phenolic, one piece snap</p> <p>ZA PTFE hollow cylinders</p> <p>TB Bartemp one piece snap self lubricating</p> <p>T Phenolic/aluminum 2 piece machined and riveted</p> <p>TMT Nylon one piece snap</p> <p>Angular Contact</p> <p>(B) Reinforced phenolic, one piece, designed to retain the balls in the outer ring</p> <p>(H) Reinforced phenolic, one piece, halo design</p> <p>(H)JB Bronze machined halo, light weight design for optimum capacity</p> <p>(H)JH Bronze machined halo, heavier section centered on ball pitch diameter</p> <p>(O)J Bronze pressed halo with formed pockets</p> <p>() indicates that the letter is already included in the nomenclature from section 3</p> <p>Pages 74 – 77</p>	<p>X___ Specific special feature code</p> <p>Y___ Specific special feature code</p> <p>X200 Oil tight seal between shield and outer ring recess</p> <p>X204 Customer part number marked on bearings</p> <p>X205 Full of balls (no cage)</p> <p>X212 Ship rings & balls unassembled (no cage required)</p> <p>X216 Shield and snap wires shipped disassembled</p>	<p>Deep Groove</p> <p>K Separating symbol</p> <p>2 See pages 84 – 85 for standard radial play tables for various sizes and types of bearings</p> <p>3</p> <p>4</p> <p>5</p> <p>6</p> <p>25 0.0002"-0.0005" (0.005mm-0.013mm)</p> <p>1117 0.0011"-0.0017" (0.028mm-0.043mm)</p> <p>Angular Contact</p> <p>Radial play in angular contact bearings is usually standardized by the design</p> <p>Pages 82 – 83</p>	<p>V Low torque assured</p> <p>VK Very low starting torque assured</p> <p>VM Very low running torque assured</p> <p>VT Individual torque trace supplied to VM limits</p> <p>Page 119</p>	<p>Deep groove</p> <p>DB Back to back mounting</p> <p>DF Face to face mounting</p> <p>DT Tandem mounting</p> <p>D Universal mounting</p> <p>XX xx is the mean preload specified in pounds</p> <p>Angular Contact</p> <p>DB Back to back mounting</p> <p>DF Face to face mounting</p> <p>DT Tandem mounting</p> <p>D Universal mounting</p> <p>DS Single Universal mounting</p> <p>L Light Preload</p> <p>M Medium Preload</p> <p>H Heavy Preload</p> <p>Pages 92 – 95</p>	<p>E Special radial runout</p> <p>R Inner ring marked for high point of radial runout</p> <p>R1 Outer ring marked for high point of radial runout</p> <p>R2 Both rings marked for high point of radial runout</p> <p>Page 105</p>	<p>C Bore and OD in 0.0001" (0.0025mm) steps</p> <p>C44 Bore and OD in 0.00005" (0.00125mm) steps</p> <p>CXO Bore only calibrated in 0.0001" (0.0025mm) steps</p> <p>C4X Bore calibrated in 0.00005" steps, OD calibrated in 0.0001" steps</p> <p>CM Bore calibrated in 1 microns steps</p> <p>Pages 135 – 136</p>	<p>O-__ Oil</p> <p>OJ-__ Oil</p> <p>G-__ Grease</p> <p>GJ-__ Grease</p> <p>Frequently used oils</p> <p>O-11 Winsorlube L-245X</p> <p>O-28 Mobil Spectrasyn 6</p> <p>O-49 Exxon Turbo Oil 2380</p> <p>OJ-201 Aeroshell Fluid 12</p> <p>OJ-273 Nye Nyosil M25</p> <p>Frequently used greases</p> <p>G-2 Exxon Beacon 325</p> <p>G-33 Mobil Grease 28</p> <p>G-44 Castrol Braycote 601 EF</p> <p>GJ-204 Aeroshell Grease 7</p> <p>GJ-264 Kluber Asonic GHY 72</p> <p>Pages 96 – 103</p>

Deep Groove Instrument (Inch)

Bore Diameters: 1.191mm to 4.762mm

- Open, shielded and sealed
- Tolerances to ABEC 7P (see pages 108 to 111)

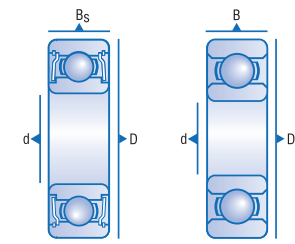

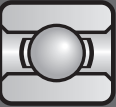
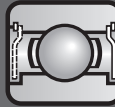
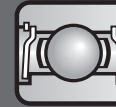
Basic Bearing Number	Bore Diameter		Outside Diameter		Width				Maximum Shaft/Housing Radius Which Bearing Corner Will Clear		nd ²	Static Capacity		Basic Dynamic Load Rating C (lbs)	Bearing Nomenclature			Attainable Speeds (RPM) by Cage Option Page 76 - 77			
	d		D		B		Bs		r Max.			Radial	Thrust					Standard Snap In Cage**	2-Piece Ribbon Cage**	TA Cage**	
	inch	mm	inch	mm	inch	mm	inch	mm	inch	mm		C _o (lbs)	T _o (lbs)							Oil	Grease
SR0	0.0469	1.191	0.1562	3.967	0.0625	1.588	0.0937	2.380	0.003	0.08	0.0059	3	8	19	SR0	SR0SS	-	-	180,000	-	-
SR1	0.0550	1.397	0.1875	4.762	0.0781	1.984	0.1094	2.779	0.003	0.08	0.0093	5	12	29	SR1	SR1SS	-	-	140,000	-	-
SR1-4	0.0781	1.984	0.2500	6.350	0.0937	2.380	0.1406	3.571	0.003	0.08	0.0124	7	20	38	SR1-4	SR1-4SS	-	100,000	100,000	220,000	220,000
SR133*	0.0937	2.380	0.1875	4.762	0.0625	1.588	0.0937	2.380	0.003	0.08	0.0078	4	13	25	SR133	SR133SS	-	105,000	105,000	200,000	200,000
SR143	0.0937	2.380	0.2500	6.350	0.0937	2.380	0.1094	2.779	0.003	0.08	0.0124	7	20	38	SR143	SR143SS	-	80,000	80,000	220,000	220,000
SR1-5	0.0937	2.380	0.3125	7.938	0.1094	2.779	0.1406	3.571	0.003	0.08	0.0234	10	20	57	SR1-5	SR1-5SS	-	75,000	-	200,000	200,000
SR144*	0.1250	3.175	0.2500	6.350	0.0937	2.380	0.1094	2.779	0.003	0.08	0.0124	7	20	38	SR144	SR144SS	-	80,000	80,000	220,000	220,000
SR144X3	0.1250	3.175	0.2500	6.350	-	-	0.0937	2.380	0.003	0.08	0.0124	7	20	38	-	SR144SSX3	-	80,000	80,000	220,000 ^{††}	220,000 ^{††}
SR2-5X2	0.1250	3.175	0.3125	7.938	-	-	0.1094	2.779	0.003	0.08	0.0234	10	20	57	-	SR2-5SX2 ^{††}	-	75,000	75,000	-	-
SR154X1	0.1250	3.175	0.3125	7.938	-	-	0.1094	2.779	0.003	0.08	0.0124	7	20	38	-	SR154SSX1	-	80,000	80,000	220,000	220,000
SR2-5	0.1250	3.175	0.3125	7.938	0.1094	2.779	0.1406	3.571	0.003	0.08	0.0234	10	20	57	SR2-5	SR2-5SS	SR2-5FF	75,000	75,000	200,000	200,000
SR2X52	0.1250	3.175	0.3750	9.525	-	-	0.1094	2.779	0.006	0.15	0.0171	10	25	45	-	SR2SSX52	-	70,000	70,000	-	-
SR2-6	0.1250	3.175	0.3750	9.525	0.1094	2.779	0.1406	3.571	0.006	0.15	0.0273	16	30	80	SR2-6	SR2-6SS	-	65,000	65,000	-	-
SR164X3	0.1250	3.175	0.3750	9.525	-	-	0.0937	2.380	0.003	0.08	0.0124	7	20	38	-	SR164SSX3	-	80,000	80,000	220,000	220,000
SR2	0.1250	3.175	0.3750	9.525	0.1562	3.967	0.1562	3.967	0.012	0.30	0.0273	10	23	66	SR2	SR2SS	SR2FF	65,000	65,000	160,000	160,000
SR174X5	0.1250	3.175	0.4100	10.414	-	-	0.0937	2.380	0.003	0.08	0.0124	7	20	38	-	SR174SSX5	-	70,000	70,000	220,000 ^{††}	220,000 ^{††}
SR174X2	0.1250	3.175	0.4250	10.795	-	-	0.1094	2.779	0.006	0.15	0.0171	10	25	45	-	SR174SSX2	-	70,000	70,000	220,000 ^{††}	220,000 ^{††}
SR184X2	0.1250	3.175	0.5000	12.700	-	-	0.1094	2.779	0.003	0.08	0.0124	7	20	38	-	SR184SSX2	-	80,000	80,000	200,000	200,000
SR2A	0.1250	3.175	0.5000	12.700	0.1719	4.366	0.1719	4.366	0.012	0.30	0.0273	10	23	66	SR2A	SR2ASS	SR2AFF	50,000	50,000	140,000	140,000
SR1204X1	0.1250	3.175	0.7500	19.050	-	-	0.1250	3.175	0.005	0.13	0.0310	20	44	87	-	SR1204SSX1	-	50,000	50,000	-	-
SR155	0.1562	3.967	0.3125	7.938	0.1094	2.779	0.1250	3.175	0.003	0.08	0.0171	10	25	45	SR155	SR155SS	-	55,000	55,000	150,000	150,000
SR156*	0.1875	4.762	0.3125	7.938	0.1094	2.779	0.1250	3.175	0.003	0.08	0.0171	10	25	45	SR156	SR156SS	-	55,000	55,000	150,000	150,000
SR156X1	0.1875	4.762	0.3125	7.938	-	-	0.1094	2.779	0.003	0.08	0.0171	10	25	45	-	SR156SX1 ^{††}	-	-	55,000	-	-
SR166*	0.1875	4.762	0.3750	9.525	0.1250	3.175	0.1250	3.175	0.003	0.08	0.0312	20	44	87	SR166	SR166SS	-	50,000	50,000	108,000 ^{††}	108,000 ^{††}
SR186X3	0.1875	4.762	0.5000	12.700	-	-	0.1094	2.779	0.005	0.13	0.0312	20	44	87	-	SR186SX3 ^{††}	-	50,000	50,000	-	-
SR186X2	0.1875	4.762	0.5000	12.700	-	-	0.1562	3.967	0.005	0.13	0.0312	20	44	87	-	SR186SSX2	-	50,000	50,000	-	-
SR3	0.1875	4.762	0.5000	12.700	0.1562	3.967	0.1960	4.978	0.012	0.30	0.0615	27	49	138	SR3 [†]	SR3SS [†]	SR3FF	45,000	45,000	135,000	135,000
SR3X8	0.1875	4.762	0.7500	19.050	-	-	0.1960	4.978	0.012	0.30	0.0615	27	49	138	-	SR3SSX8	-	45,000	45,000	135,000	135,000

*Also available with extended inner ring.

**Attainable speed is determined by cage, not lubricant type. †Also available with T-Cage option. ††Available only with single shield.

Deep Groove Instrument (Metric)

Bore Diameters: 1.500mm to 9.000mm

- Open, shielded and sealed
- Tolerances to ABEC 7P (see pages 108 to 111)

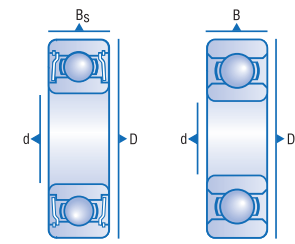

Basic Bearing Number	Bore Diameter		Outside Diameter		Width		Maximum Shaft/Housing Radius Which Bearing Corner Will Clear		nd ²	Static Capacity		Basic Dynamic Load Rating	Bearing Nomenclature			Attainable Speeds (RPM) by Cage Option Page 76 – 77						
	d		D		B		r Max.			Radial	Thrust		Open	Shielded	Flexeal	Standard Snap In Cage**	2-Piece Ribbon Cage**	TA Cage**		T Cage**		
	mm	inch	mm	inch	mm	inch	mm	inch		C _o (lbs)	T _o (lbs)							C (lbs)	Oil	Grease	Oil	Grease
S18M1-5	1.500	0.0591	4.000	0.1575	1.200	0.0472	0.08	0.003	0.0059	3	9	20	S18M1-5	-	-	-	160,000	-	-	-	-	
S19M1-5	1.500	0.0591	5.000	0.1969	2.000	0.0787	0.15	0.006	0.0078	4	13	25	S19M1-5Y1	S19M1-5SSY1	-	-	125,000	-	-	-	-	
S19M2	2.000	0.0787	6.000	0.2362	2.300	0.0905	0.15	0.006	0.0109	6	17	34	S19M2Y1	S19M2SSY1	-	-	120,000	-	-	-	-	
S18M2-5	2.500	0.0984	6.000	0.2362	1.800	0.0709	0.15	0.006	0.0124	7	20	38	S18M2-5	-	-	-	100,000	-	-	-	-	
S38M2-5	2.500	0.0984	6.000	0.2362	2.600	0.1024	0.15	0.006	0.0124	7	20	38	S38M2-5	S38M2-5SS	-	-	100,000	240,000	240,000	-	-	
S19M2-5	2.500	0.0984	7.000	0.2756	2.500	0.0984	0.15	0.006	0.0124	7	20	38	S19M2-5Y1	S19M2-5SSY1	-	-	100,000	100,000	240,000	240,000	-	-
S38M3	3.000	0.1181	7.000	0.2756	3.000	0.1181	0.15	0.006	0.0154	9	23	47	S38M3	S38M3SS	-	-	85,000	-	-	-	-	
S2M3	3.000	0.1181	10.000	0.3937	4.000	0.1575	0.15	0.006	0.0273	10	23	66	S2M3Y1	S2M3SSY1	-	-	80,000	80,000	200,000	200,000	-	-
S18M4	4.000	0.1575	9.000	0.3543	2.500	0.0984	0.18	0.007	0.0273	16	30	80	S18M4	-	-	-	65,000	65,000	-	-	-	-
S38M4	4.000	0.1575	9.000	0.3543	4.000	0.1575	0.15	0.006	0.0273	10	23	66	S38M4	S38M4SS	-	-	65,000	65,000	200,000	200,000	-	-
S2M4	4.000	0.1575	13.000	0.5118	5.000	0.1969	0.18	0.007	0.0615	27	49	138	S2M4	S2M4SS	-	-	55,000	55,000	150,000	150,000	-	-
34	4.000	0.1575	16.000	0.6299	5.000	0.1969	0.30	0.012	0.0940	38	64	199	34	34SS	34FF	-	50,000	120,000 [†]	120,000 [†]	200,000 ^{††}	140,000 ^{††}	
S19M5	5.000	0.1969	13.000	0.5118	4.000	0.1575	0.15	0.006	0.0430	27	57	106	-	S19M5SS	-	-	40,000	100,000	100,000	-	-	
34-5	5.000	0.1969	16.000	0.6299	5.000	0.1969	0.30	0.012	0.0940	38	64	199	34-5	34-5SS	34-5FF	-	50,000	120,000 [†]	120,000 [†]	200,000 ^{††}	140,000 ^{††}	
35	5.000	0.1969	19.000	0.7480	6.000	0.2362	0.30	0.012	0.1187	53	84	256	35	35SS	-	-	40,000	100,000 [†]	100,000 [†]	160,000 ^{††}	115,000 ^{††}	
36	6.000	0.2362	19.000	0.7480	6.000	0.2362	0.30	0.012	0.1187	53	84	256	36	36SS	-	-	40,000	100,000 [†]	100,000 [†]	-	-	
S18M7Y2	7.000	0.2756	14.000	0.5512	4.000	0.1575	0.15	0.006	0.0560	38	71	143	S18M7Y2	-	-	-	35,000	-	-	-	-	
37	7.000	0.2756	22.000	0.8661	7.000	0.2756	0.30	0.012	0.1710	83	123	349	37	37SS	37FF	-	32,000	75,000 [†]	75,000 [†]	120,000 ^{††}	86,000 ^{††}	
37X2	7.000	0.2756	22.000	0.8661	10.310	0.4060	0.30	0.012	0.1710	215	81	590	-	37SSX2	37FFX2	-	-	-	-	120,000	86,000	
38	8.000	0.3150	22.000	0.8661	7.000	0.2756	0.30	0.012	0.1710	83	123	349	38	38SS	38FF	-	32,000	75,000 [†]	75,000 [†]	120,000 ^{††}	86,000 ^{††}	
38X2	8.000	0.3150	22.000	0.8661	10.310	0.4060	0.30	0.012	0.1710	215	81	590	-	38SSX2	38FFX2	-	-	-	-	120,000	86,000	
38X6	8.000	0.3150	24.000	0.9449	10.310	0.4060	0.30	0.012	0.1710	215	81	590	-	38SSX6	38FFX6	-	-	-	-	120,000	86,000	
39	9.000	0.3543	26.000	1.0236	8.000	0.3150	0.40	0.016	0.2461	495	311	849	39	39SS	-	-	25,000	-	-	-	-	

**Attainable speed is determined by cage, not lubricant type. †Available only with single shield. ††T-cage option available unshielded only.

Deep Groove Flanged (Inch)

Bore Diameters: 1.191mm to 9.525mm

- Open, shielded and sealed
- Tolerances to ABEC 7P (see pages 108 to 111)

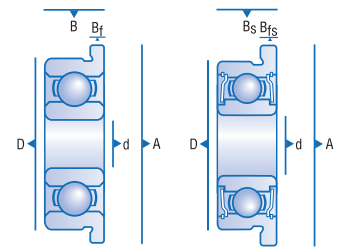

Basic Bearing Number	Bore Diameter		Outside Diameter		Width				Maximum Shaft/Housing Radius Which Bearing Corner Will Clear		Flange Diameter		Flange Width				nd ²	Static Capacity			Basic Dynamic Load Rating	Bearing Nomenclature			Attainable Speeds (RPM) by Cage Option Page 76 – 77			
	d		D		B		Bs		r Max.		A		Bf		Bfs			C ₀ (lbs)	T ₀ (lbs)	C (lbs)		Open	Shielded	Flexeal	Standard Snap In Cage**	2-Piece Ribbon Cage**	TA Cage**	
	inch	mm	inch	mm	inch	mm	inch	mm	inch	mm	inch	mm	inch	mm	inch	mm											Oil	Grease
SFR0	0.0469	1.191	0.1562	3.967	0.0625	1.588	0.0937	2.380	0.003	0.08	0.203	5.160	0.013	0.330	0.031	0.790	0.0059	3	8	19	SFR0	SFR0SS	-	-	180,000	-	-	
SFR1	0.0550	1.397	0.1875	4.762	0.0781	1.984	0.1094	2.779	0.003	0.08	0.234	5.940	0.023	0.580	0.031	0.790	0.0093	5	12	29	SFR1	SFR1SS	-	-	140,000	-	-	
SFR1-4	0.0781	1.984	0.2500	6.350	0.0937	2.380	0.1406	3.571	0.003	0.08	0.296	7.520	0.023	0.580	0.031	0.790	0.0124	7	20	38	SFR1-4	SFR1-4SS	-	100,000	100,000	220,000	220,000	
SFR133*	0.0937	2.380	0.1875	4.762	0.0625	1.588	0.0937	2.380	0.003	0.08	0.234	5.940	0.018	0.460	0.031	0.790	0.0078	4	13	25	SFR133	SFR133SS	-	105,000	105,000	216,000	216,000	
SFR1-5	0.0937	2.380	0.3125	7.938	0.1094	2.779	0.1406	3.571	0.003	0.08	0.359	9.120	0.023	0.580	0.031	0.790	0.0234	10	20	57	SFR1-5	SFR1-5SS	-	75,000	75,000	200,000	200,000	
SFR144*	0.1250	3.175	0.2500	6.350	0.0937	2.380	0.1094	2.779	0.003	0.08	0.296	7.520	0.023	0.580	0.031	0.790	0.0124	7	20	38	SFR144	SFR144SS	-	80,000	80,000	220,000	220,000	
SFR2-5	0.1250	3.175	0.3125	7.938	0.1094	2.779	0.1406	3.571	0.003	0.08	0.359	9.120	0.023	0.580	0.031	0.790	0.0234	10	20	57	SFR2-5	SFR2-5SS	SFR2-5FF	75,000	75,000	200,000	200,000	
SFR2-6	0.1250	3.175	0.3750	9.525	0.1094	2.779	0.1406	3.571	0.006	0.15	0.422	10.720	0.023	0.580	0.031	0.790	0.0273	16	30	80	SFR2-6	SFR2-6SS	-	65,000	65,000	160,000	160,000	
SFR2	0.1250	3.175	0.3750	9.525	0.1562	3.967	0.1562	3.967	0.012	0.30	0.440	11.180	0.030	0.760	0.030	0.760	0.0273	10	23	66	SFR2	SFR2SS	SFR2FF	65,000	65,000	160,000	160,000	
SFR155	0.1562	3.967	0.3125	7.938	0.1094	2.779	0.1250	3.175	0.003	0.08	0.359	9.120	0.023	0.580	0.036	0.910	0.0171	10	25	45	SFR155	SFR155SS	-	55,000	55,000	150,000	150,000	
SFR156*	0.1875	4.762	0.3125	7.938	0.1094	2.779	0.1250	3.175	0.003	0.08	0.359	9.120	0.023	0.580	0.036	0.910	0.0171	10	25	45	SFR156	SFR156SS	-	55,000	55,000	150,000	150,000	
SFR166*	0.1875	4.762	0.3750	9.525	0.1250	3.175	0.1250	3.175	0.003	0.08	0.422	10.720	0.023	0.580	0.031	0.790	0.0312	20	44	87	SFR166	SFR166SS	-	50,000	50,000	140,000 ^{††}	140,000 ^{††}	
SFR3X3	0.1875	4.762	0.5000	12.700	0.1562	3.967	-	-	0.012	0.30	0.565	14.350	0.042	1.070	-	-	0.0615	27	49	138	SFR3X3	-	-	45,000	45,000	-	-	
SFR3	0.1875	4.762	0.5000	12.700	0.1960	4.978	0.1960	4.978	0.012	0.30	0.565	14.350	0.042	1.070	0.042	1.070	0.0615	27	49	138	SFR3'	SFR3SS'	SFR3FF	45,000	45,000	135,000	135,000	
SFR168	0.2500	6.350	0.3750	9.525	0.1250	3.175	0.1250	3.175	0.003	0.08	0.422	10.720	0.023	0.580	0.036	0.910	0.0171	8	22	38	SFR168	SFR168SS	-	48,000	-	-	-	
SFR188*	0.2500	6.350	0.5000	12.700	0.1250	3.175	0.1875	4.762	0.005	0.13	0.547	13.890	0.023	0.580	0.045	1.140	0.0430	27	57	106	SFR188	SFR188SS	-	-	42,000	110,000	110,000	
SFR4	0.2500	6.350	0.6250	15.875	0.1960	4.978	0.1960	4.978	0.012	0.30	0.690	17.530	0.042	1.070	0.042	1.070	0.0703	35	63	156	SFR4'	SFR4SS'	SFR4FF	40,000	40,000	105,000	105,000	
SFR1810	0.3125	7.938	0.5000	12.700	0.1562	3.967	0.1562	3.967	0.005	0.13	0.547	13.890	0.031	0.790	0.031	0.790	0.0430	27	56	104	SFR1810	SFR1810SS	-	-	32,000	-	-	
SFR6	0.3750	9.525	0.8750	22.225	0.2812	7.142	0.2812	7.142	0.016	0.41	0.969	24.610	0.062	1.570	0.062	1.570	0.1710	83	123	349	SFR6	SFR6SS	SFR6FF	-	24,000	55,000	55,000	

*Also available with extended inner ring.

**Attainable speed is determined by cage, not lubricant type. †Also available with T-Cage option. ††Available only with single shield.

Deep Groove Thin Section (Inch)

Bore Diameters: 15.875mm to 39.688mm

- Open, shielded and sealed
- For SN500 bearings tolerances are to ABEC 7T 'thin series', for A500 bearings tolerances are to Barden 'A500' (see pages 108 to 111)

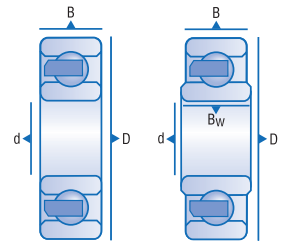

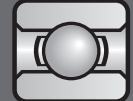
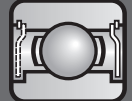
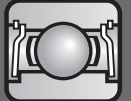
500 SERIES Basic Bearing Number	Bore Diameter		Outside Diameter		Width Outer Ring		Width Inner Ring		Maximum Shaft/Housing Radius Which Bearing Corner Will Clear		nd ²	Static Capacity		Basic Dynamic Load Rating C (lbs)	Bearing Nomenclature			Attainable Speeds (RPM) by Cage Option Page 76 – 77					
	d		D		B		B _w		r Max.			Radial	Thrust					Separators**		TA Cage**		T Cage**	
	inch	mm	inch	mm	inch	mm	inch	mm	inch	mm		C ₀ (lbs)	T ₀ (lbs)		Open	Shielded	Flexeal	Toroids	ZA	Oil	Grease	Oil	Grease
SN538ZA	0.6250	15.875	1.0625	26.988	0.2500	6.350	0.2500	6.350	0.015	0.38	0.1406	144	343	373	SN538ZA	SN538SSZA	-	-	290	-	-	-	-
SN538TA	0.6250	15.875	1.0625	26.988	0.2500	6.350	0.2500	6.350	0.015	0.38	0.1875	188	457	447	SN538TA	SN538SSTA	-	-	-	31,000	31,000	-	-
A538ZA	0.6250	15.875	1.0625	26.988	0.2500	6.350	0.2812	7.142	0.015	0.38	0.1406	310	237	464	A538ZA	A538SSZA	-	-	290	-	-	-	-
A538T	0.6250	15.875	1.0625	26.988	0.2500	6.350	0.2812	7.142	0.015	0.38	0.1563	226	248	493	A538T	A538SST	-	-	-	-	-	57,000	37,000
SN539ZA	0.7500	19.050	1.1875	30.163	0.2500	6.350	0.2500	6.350	0.015	0.38	0.1719	177	433	418	SN539ZA	SN539SSZA	-	-	250	-	-	-	-
SN539TA	0.7500	19.050	1.1875	30.163	0.2500	6.350	0.2500	6.350	0.015	0.38	0.2188	228	551	483	SN539TA	SN539SSTA	-	-	-	27,000	27,000	-	-
A539ZA	0.7500	19.050	1.1875	30.163	0.2500	6.350	0.2812	7.142	0.015	0.38	0.1719	256	277	517	A539ZA	A539SSZA	A539FFZA	-	250	-	-	-	-
A539T	0.7500	19.050	1.1875	30.163	0.2500	6.350	0.2812	7.142	0.015	0.38	0.1875	280	302	548	A539T	A539SST	A539FFT	-	-	-	-	49,000	32,000
SN540ZA	0.8750	22.225	1.3125	33.338	0.2500	6.350	0.2500	6.350	0.015	0.38	0.2031	216	525	456	SN540ZA	SN540SSZA	-	-	220	-	-	-	-
SN540TA	0.8750	22.225	1.3125	33.338	0.2500	6.350	0.2500	6.350	0.015	0.38	0.2188	361	600	484	SN540TA	SN540SSTA	-	-	-	24,000	24,000	-	-
A540ZA	0.8750	22.225	1.3125	33.338	0.2500	6.350	0.2812	7.142	0.015	0.38	0.2031	312	330	566	A540ZA	A540SSZA	-	-	220	-	-	-	-
A540T	0.8750	22.225	1.3125	33.338	0.2500	6.350	0.2812	7.142	0.015	0.38	0.2188	336	354	596	A540T	A540SST	-	-	-	-	-	44,000	25,000
SN541ZA	1.0625	26.988	1.5000	38.100	0.2500	6.350	0.2500	6.350	0.015	0.38	0.2344	256	623	484	SN541ZA	SN541SSZA	-	-	190	-	-	-	-
SN541TA	1.0625	26.988	1.5000	38.100	0.2500	6.350	0.2500	6.350	0.015	0.38	0.2813	477	764	552	SN541TA	SN541SSTA	-	-	-	21,000	21,000	-	-
A541ZA	1.0625	26.988	1.5000	38.100	0.2500	6.350	0.2812	7.142	0.015	0.38	0.2344	367	376	603	A541ZA	A541SSZA	-	-	190	-	-	-	-
A541T	1.0625	26.988	1.5000	38.100	0.2500	6.350	0.2812	7.142	0.015	0.38	0.2500	392	401	629	A541T	A541SST	-	-	-	-	-	37,000	24,000
SN542ZA	1.3125	33.338	1.7500	44.450	0.2500	6.350	0.2500	6.350	0.015	0.38	0.2969	333	811	541	SN542ZA	SN542SSZA	-	-	150	-	-	-	-
SN542TA	1.3125	33.338	1.7500	44.450	0.2500	6.350	0.2500	6.350	0.015	0.38	0.3125	542	838	566	SN542TA	SN542SSTA	-	-	-	17,000	17,000	-	-
A542ZA	1.3125	33.338	1.7500	44.450	0.2500	6.350	0.2812	7.142	0.015	0.38	0.2969	478	473	678	A542ZA	A542SSZA	-	-	150	-	-	-	-
A542T	1.3125	33.338	1.7500	44.450	0.2500	6.350	0.2812	7.142	0.015	0.38	0.2813	453	448	654	A542T	A542SST	-	-	-	-	-	31,000	20,000
SN543ZA	1.5625	39.688	2.0000	50.800	0.2500	6.350	0.2500	6.350	0.015	0.38	0.3438	391	956	567	SN543ZA	SN543SSZA	-	-	130	-	-	-	-
SN543TA	1.5625	39.688	2.0000	50.800	0.2500	6.350	0.2500	6.350	0.015	0.38	0.4060	722	1,105	641	SN543TA	SN543SSTA	-	-	-	15,000	15,000	-	-
A543ZA	1.5625	39.688	2.0000	50.800	0.2500	6.350	0.2812	7.142	0.015	0.38	0.3438	562	551	721	A543ZA	A543SSZA	-	-	130	-	-	-	-
A543T	1.5625	39.688	2.0000	50.800	0.2500	6.350	0.2812	7.142	0.015	0.38	0.3438	562	551	721	A543T	A543SST	-	-	-	-	-	26,000	17,000

**Attainable speed is determined by cage, not lubricant type.

Thin Section (Inch)

Bore Diameters: 4" to 8"

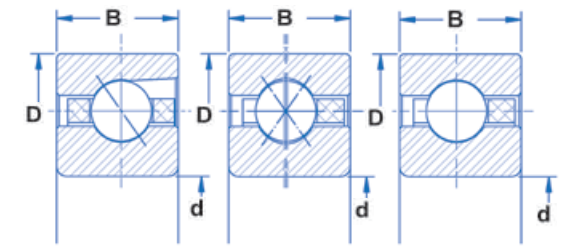

The Barden product offering includes larger diameter thin section ball bearings. Produced in standard cross sections and configurations, thin section bearings manufactured by Barden can be customised to meet the unique needs of each application.

Material options include:

Rings

- SAE 52100.
- CRONIDUR 30®.
- AISI 440C.

Balls

- SAE 52100, AISI 440C.
- SILICON NITRIDE/CERAMIC.

Separators

- BRONZE OR PHENOLIC CAGES.
- CUSTOM SPACERS FROM A VARIETY OF MATERIALS, INCLUDING BARDEN SPIN MATERIAL.

Thin section bearings are available in sizes up to 10 inches in diameter, both conrad and angular contact. Bearings can be produced in accordance with all ABEC tolerances, including ABEC 7T, and material certification can be provided on request. The Barden Product Engineering Department is available to offer assistance with bearing selection and application engineering.

Nomenclature

Eg. XC Z T A(M) Oxx A X-
(1) (2) (3) (4) (5) (6) (7)

1 – Material

C – Ceramic balls
CS – Ceramic balls, stainless steel rings
XC – Ceramic balls, Cronidur 30® rings

2 –

Z – Barden Special

3 –

T – Thin Section

4 – Bearing Type

A – Angular Contact
X – Four-point Contact
(Standard is Inch. Metric also available with TAM designation)

5 – Bearing Sizes

Size designation indicates bore per table. Consult Barden engineering for metric sizes. Smaller and larger sizes than those shown also available.

6 – Bearing Cross Section

A – 1/4" square
B – 5/16" square
C – 3/8" square
D – 1/2" square

7 – X indicates special configurations & designs.

Consult Barden Engineering for all unique needs.

Basic Bearing Number	Bearing Type	Bore Diameter		Outside Diameter		Width		Static Capacity	
		d		D		B		Radial	Thrust
		inch	mm	inch	mm	inch	mm	C ₀ (lbs)	T ₀ (lbs)
ZTA040A	A	4.000	101.60	4.500	114.30	0.250	6.35	1569	4443
ZTX040A	X	4.000	101.60	4.500	114.30	0.250	6.35	1177	3332
ZTA040B	A	4.000	101.60	4.625	117.48	0.313	7.94	2129	6091
ZTX040B	X	4.000	101.60	4.625	117.48	0.313	7.94	1615	4620
ZTA040C	A	4.000	101.60	4.750	120.65	0.375	9.53	2636	7229
ZTX040C	X	4.000	101.60	4.750	120.65	0.375	9.53	1990	5459
ZTA040D	A	4.000	101.60	5.000	127.00	0.500	12.70	3639	8902
ZTX040D	X	4.000	101.60	5.000	127.00	0.500	12.70	2729	6677
ZTA045A	A	4.500	114.30	5.000	127.00	0.250	6.35	1760	4783
ZTX045A	X	4.500	114.30	5.000	127.00	0.250	6.35	1320	3581
ZTA047A	A	4.750	120.65	5.250	133.35	0.250	6.35	1856	5242
ZTX047A	X	4.750	120.65	5.250	133.35	0.250	6.35	1392	3931
ZTA050A	A	5.000	127.00	5.500	139.70	0.250	6.35	1951	5508
ZTX050A	X	5.000	127.00	5.500	139.70	0.250	6.35	1463	4131
ZTA055A	A	5.500	139.70	6.000	152.40	0.250	6.35	2142	6040
ZTX055A	X	5.500	139.70	6.000	152.40	0.250	6.35	1607	4530
ZTA060A	A	6.000	152.40	6.500	165.10	0.250	6.35	2333	6318
ZTX060A	X	6.000	152.40	6.500	165.10	0.250	6.35	1750	4739
ZTA065A	A	6.500	165.10	7.000	177.80	0.250	6.35	2524	7104
ZTX065A	X	6.500	165.10	7.000	177.80	0.250	6.35	1893	5328
ZTA070A	A	7.000	177.80	7.500	190.50	0.250	6.35	2715	7965
ZTX070A	X	7.000	177.80	7.500	190.50	0.250	6.35	2037	5974
ZTA075A	A	7.500	190.50	8.000	203.20	0.250	6.35	2906	8526
ZTX075A	X	7.500	190.50	8.000	203.20	0.250	6.35	2180	6395
ZTA080A	A	8.000	203.20	8.500	215.90	0.250	6.35	3098	9088
ZTX080A	X	8.000	203.20	8.500	215.90	0.250	6.35	2323	6816

*Only A cross section listed after first size.

Deep Groove Spindle and Turbine (Metric)

Bore Diameters: 10mm to 25mm

- Open, shielded and sealed
- Tolerances to ABEC 7 (see pages 108 to 111)

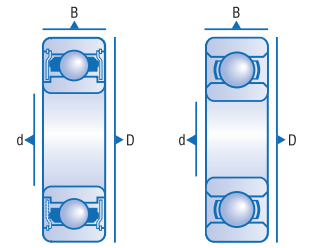

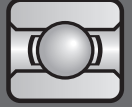
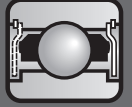
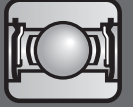
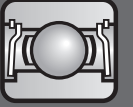
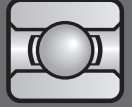
Basic Bearing Number	Bore Diameter		Outside Diameter		Width		Maximum Shaft/Housing Radius Which Bearing Corner Will Clear		nd ²	Static Capacity		Basic Dynamic Load Rating C (lbs)	Bearing Nomenclature				Attainable Speeds (RPM) by Cage Option Page 76 - 77			
	d		D		B		r Max.			Radial	Thrust						2-Piece Ribbon Cage**	TMT Cage**	T Cage**	
	mm	inch	mm	inch	mm	inch	mm	inch		C _o (lbs)	T _o (lbs)		Open	Shielded	Sealed	Flexeal			Oil	Grease
100	10.000	0.3937	26.000	1.0236	8.000	0.3150	0.30	0.012	0.246	627	340	1,001		100SS	-	-	26,500	-	-	-
100X1	10.000	0.3937	26.000	1.0236	11.510	0.4531	0.30	0.012	0.246	384	472	1,018	-	100SS(T)X1	-	100FF(T)X1	26,500	-	106,000	85,000
200	10.000	0.3937	30.000	1.1811	9.000	0.3543	0.64	0.025	0.335	694	521	1,326	200(T)	200SS	-	200FF	25,000	-	100,000	85,000
101	12.000	0.4724	28.000	1.1024	8.000	0.3150	0.30	0.012	0.281	485	515	1,125	101T	-	-	-	-	89,000	70,833	
101X1	12.000	0.4724	28.000	1.1024	11.510	0.4531	0.30	0.012	0.281	759	403	1,111	-	101SSTX1	-	101FFTXX1	-	-	89,000	70,833
101X1	12.000	0.4724	28.000	1.1024	11.510	0.4531	0.30	0.012	0.281	759	403	1,111	-	101SSTMTX1	-	101FFTMTX1	-	26,500	-	-
201	12.000	0.4724	32.000	1.2598	10.000	0.3937	0.64	0.025	0.385	806	566	1,511	201(T)	201SS	201VV	201FF	20,500	-	83,000	70,833
9201	12.000	0.4724	32.000	1.2598	15.875	0.6250	0.64	0.025	0.385	806	566	1,511	9201(T)	9201SS(T)	9201VV(T)	9201FF(T)	20,500	-	83,000	70,833
201X1	13.000	0.5118	32.000	1.2598	12.700	0.5000	0.64	0.025	0.385	806	566	1,511	201(T)X1	201SS(T)X1	201VV(T)X1	201FF(T)X1	20,500	-	83,000	65,385
1902X1	15.000	0.5906	28.000	1.1024	7.000	0.2756	0.30	0.012	0.218	501	438	787	1902TX1	-	-	1902FFTXX1	-	-	67,000	56,667
102	15.000	0.5906	32.000	1.2598	9.000	0.3543	0.30	0.012	0.316	740	658	1,222	102T	102SSTMT	-	102FFTMT	-	20,000	71,000	56,667
202	15.000	0.5906	35.000	1.3780	11.000	0.4331	0.64	0.025	0.438	937	703	1,713	202(T)	202SS(T)	202YY	202FF(T)	16,800	-	67,000	56,667
202	15.000	0.5906	35.000	1.3780	11.000	0.4331	0.64	0.025	0.438	937	703	1,713	202TMT	202SSTMT	202YYTMT	202FFTMT	-	20,000	-	-
202X1	15.000	0.5906	35.000	1.3780	12.700	0.5000	0.64	0.025	0.438	937	703	1,713	202(T)X1	202SS(T)X1	-	202FF(T)X1	16,800	-	67,000	56,667
9302X1	15.000	0.5906	35.000	1.3780	19.000	0.7501	1.00	0.040	0.438	937	703	1,713	9302X1	-	-	9302FFTXX1	-	-	67,000	56,667
103	17.000	0.6693	35.000	1.3780	10.000	0.3937	0.30	0.012	0.352	1,026	476	1,291	103(T)	103SS(T)	-	103FF(T)	15,400	-	62,000	50,000
203	17.000	0.6693	40.000	1.5748	12.000	0.4724	0.64	0.025	0.565	1,258	1,090	2,112	203(T)	203SS(T)	203YY	203FF(T)	14,800	-	59,000	50,000
203	17.000	0.6693	40.000	1.5748	12.000	0.4724	0.64	0.025	0.565	1,258	1,090	2,112	203TMT	203SSTMT	-	203FFTMT	-	17,600	-	-
9203	17.000	0.6693	40.000	1.5748	17.460	0.6875	0.64	0.025	0.565	1,258	1,090	2,112	9203(T)	9203SS(T)	9203VV(T)	9203FF(T)	14,800	-	59,000	50,000
104	20.000	0.7874	42.000	1.6535	12.000	0.4724	0.64	0.025	0.563	1,456	943	2,076	104T	104SST	-	104FFT	-	-	53,000	42,500
204	20.000	0.7874	47.000	1.8504	14.000	0.5512	1.00	0.040	0.781	1,747	1,512	2,840	204(T)	204SS(T)	204YY(T)	204FF(T)	12,500	-	50,000	42,500
204	20.000	0.7874	47.000	1.8504	14.000	0.5512	1.00	0.040	0.781	1,747	1,512	2,840	204TMT	204SSTMT	204YYTMT	204FFTMT	-	15,000	-	-
9204	20.000	0.7874	47.000	1.8504	20.640	0.8125	1.00	0.040	0.781	1,747	1,512	2,840	9204(T)	9204SS(T)	9204VV(T)	9204FF(T)	12,500	-	50,000	42,500
9204	20.000	0.7874	47.000	1.8504	20.640	0.8125	1.00	0.040	0.781	1,747	1,512	2,840	9204TMT	9204SSTMT	9204VVTMT	9204FFTMT	-	15,000	-	-
105	25.000	0.9843	47.000	1.8504	12.000	0.4724	0.64	0.025	0.625	1,522	2,069	2,203	105T	105SST	-	105FFT	-	-	42,500	34,000
205	25.000	0.9843	52.000	2.0472	15.000	0.5906	1.00	0.040	0.879	2,046	1,742	3,097	205(T)	205SS(T)	205YY(T)	205FF(T)	10,000	-	40,000	34,000
205	25.000	0.9843	52.000	2.0472	15.000	0.5906	1.00	0.040	0.879	2,046	1,742	3,097	205TMT	205SSTMT	205YYTMT	205FFTMT	-	12,000	-	-
9205	25.000	0.9843	52.000	2.0472	20.640	0.8125	1.00	0.040	0.879	2,046	1,742	3,097	9205(T)	9205SS(T)	9205VV(T)	9205FF(T)	10,000	-	40,000	34,000

**Attainable speed is determined by cage, not lubricant type.

Deep Groove Spindle and Turbine (Metric)

Bore Diameters: 25mm to 45mm

- Open, shielded and sealed
- Tolerances to ABEC 7 (see pages 108 to 111)

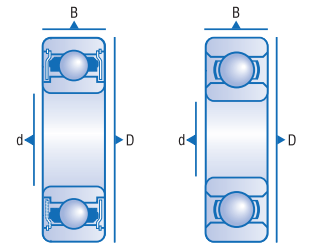

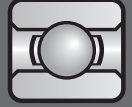
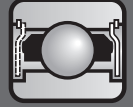
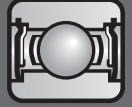
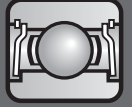
Basic Bearing Number	Bore Diameter		Outside Diameter		Width		Maximum Shaft/Housing Radius Which Bearing Corner Will Clear		nd ²	Static Capacity		Basic Dynamic Load Rating C (lbs)	Bearing Nomenclature				Attainable Speeds (RPM) by Cage Option Page 76 – 77			
	d		D		B		r Max.			Radial	Thrust						2-Piece Ribbon Cage**	TMT Cage**	T Cage**	
	mm	inch	mm	inch	mm	inch	mm	inch		C _o (lbs)	T _o (lbs)		Open	Shielded	Sealed	Flexeal			Oil	Grease
9205	25.000	0.9843	52.000	2.0472	20.640	0.8125	1.00	0.040	0.879	2,046	1,742	3,097	9205TMT	9205SSTMT	9205VVTMT	9205FFTMT	-	12,000	-	-
305	25.000	0.9843	62.000	2.4409	17.000	0.6693	1.00	0.040	1.340	2,862	4,177	4,720	305T	305SST	-	305FFT	-	-	40,000	34,000
9305	25.000	0.9843	62.000	2.4409	39.370	1.0000	1.00	0.040	1.340	2,862	4,177	4,720	9305T	9305SST	-	9305FFT	-	-	40,000	34,000
106	30.000	1.1811	55.000	2.1654	13.000	0.5118	1.00	0.040	0.870	2,151	1,804	2,918	106T	106SST	-	106FFT	-	-	35,000	28,333
206	30.000	1.1811	62.000	2.4409	16.000	0.6299	1.00	0.040	1.270	2,943	2,508	4,288	206(T)	206SS(T)	206VV(T)	206FF(T)	8,400	-	33,500	28,333
206	30.000	1.1811	62.000	2.4409	16.000	0.6299	1.00	0.040	1.270	2,943	2,508	4,288	206TMT	206SSTMT	206VVTMT	206FFTMT	-	10,000	-	-
9206	30.000	1.1811	62.000	2.4409	23.810	0.9375	1.00	0.040	1.270	2,943	2,508	4,288	9206(T)	9206SS(T)	9206VV(T)	9206FF(T)	8,400	-	33,500	28,333
9206	30.000	1.1811	62.000	2.4409	23.810	0.9375	1.00	0.040	1.270	2,943	2,508	4,288	9206TMT	9206SSTMT	9206VVTMT	9206FFTMT	-	10,000	-	-
107	35.000	1.3780	62.000	2.4409	14.000	0.5512	1.00	0.040	1.074	2,629	3,420	3,534	107T	107SST	-	107FFT	-	-	30,500	24,286
207	35.000	1.3780	72.000	2.8346	17.000	0.6693	1.00	0.040	1.723	4,004	4,628	5,678	207(T)	207SS(T)	-	207FF(T)	7,100	-	28,500	24,286
207	35.000	1.3780	72.000	2.8346	17.000	0.6693	1.00	0.040	1.723	4,004	4,628	5,678	207TMT	207SSTMT	-	207FFTMT	-	8,500	-	-
9207	35.000	1.3780	72.000	2.8346	26.990	1.0625	1.00	0.040	1.723	4,004	4,628	5,678	9207(T)	9207SS(T)	-	9207FF(T)	7,100	-	28,500	24,286
9207	35.000	1.3780	72.000	2.8346	26.990	1.0625	1.00	0.040	1.723	4,004	4,628	5,678	9207TMT	9207SSTMT	-	9207FFTMT	-	8,500	-	-
307	35.000	1.3780	80.000	3.1496	21.000	0.8268	1.50	0.060	2.215	4,792	6,961	7,458	307T	307SST	-	307FFT	-	-	28,500	24,286
307	35.000	1.3780	80.000	3.1496	21.000	0.8268	1.50	0.060	2.215	4,792	6,961	7,458	307TMT	307SSTMT	-	307FFTMT	-	6,900	-	-
9307	35.000	1.3780	80.000	3.1496	34.920	1.3750	1.50	0.060	2.215	4,792	6,961	7,458	9307T	9307SST	-	9307FFT	-	-	28,500	24,286
9307	35.000	1.3780	80.000	3.1496	34.920	1.3750	1.50	0.060	2.215	4,792	6,961	7,458	9307TMT	9307SSTMT	-	9307FFTMT	-	6,900	-	-
108	40.000	1.5748	68.000	2.6772	15.000	0.5906	1.00	0.040	1.172	3,015	2,858	3,676	108T	108SST	-	-	-	-	27,000	21,250
208	40.000	1.5748	80.000	3.1496	18.000	0.7087	1.00	0.040	1.978	4,659	6,041	6,439	208T	208SST	208VVT	208FFT	-	-	25,000	21,250
208	40.000	1.5748	80.000	3.1496	18.000	0.7087	1.00	0.040	1.978	4,659	6,041	6,439	208TMT	208SSTMT	208YYTMT	208FFTMT	-	7,500	-	-
9208	40.000	1.5748	80.000	3.1496	30.160	1.1875	1.00	0.040	1.978	4,659	6,041	6,439	9208T	9208SST	9208VVT	9208FFT	-	-	25,000	21,250
9208	40.000	1.5748	80.000	3.1496	30.160	1.1875	1.00	0.040	1.978	4,659	6,041	6,439	9208TMT	9208SSTMT	9208YYTMT	9208FFTMT	-	7,500	-	-
308	40.000	1.5748	90.000	3.1496	23.000	0.9055	1.50	0.060	3.125	6,912	9,668	9,911	308TMT	308SSTMT	-	-	-	6,000	-	-
9308	40.000	1.5748	90.000	3.1496	36.510	1.4375	1.50	0.060	3.125	6,912	9,668	9,911	9308TMT	9308SSTMT	-	-	-	6,000	-	-
109	45.000	1.7717	75.000	2.9578	16.000	0.6299	1.00	0.040	1.547	3,894	5,220	4,828	109TMT	-	-	109FFTMT	-	7,000	-	-
209	45.000	1.7717	85.000	3.3465	19.000	0.7480	1.00	0.040	2.197	5,300	5,223	6,893	209T	209SST	-	-	-	-	23,000	18,889
209	45.000	1.7717	85.000	3.3465	19.000	0.7480	1.00	0.040	2.197	5,300	5,223	6,893	209TMT	209SSTMT	-	-	-	6,700	-	-
9209	45.000	1.7717	85.000	3.3465	30.160	1.1875	1.00	0.040	2.197	5,300	5,223	6,893	9209T	9209SST	-	-	-	-	23,000	18,889

**Attainable speed is determined by cage, not lubricant type.

Deep Groove Spindle and Turbine (Metric)

Bore Diameters: 45mm to 160mm

- Open, shielded and sealed
- Tolerances to ABEC 7 (see pages 108 to 111)

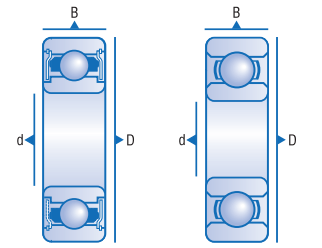

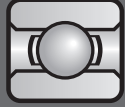
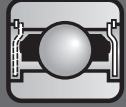
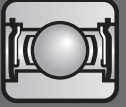
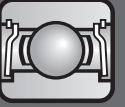
Basic Bearing Number	Bore Diameter		Outside Diameter		Width		Maximum Shaft/Housing Radius Which Bearing Corner Will Clear		nd ²	Static Capacity		Basic Dynamic Load Rating	Bearing Nomenclature				Attainable Speeds (RPM) by Cage Option Page 76 – 77				
	d		D		B		r Max.			Radial	Thrust		C (lbs)					2-Piece Ribbon Cage**	TMT Cage**	T Cage**	
	mm	inch	mm	inch	mm	inch	mm	inch		C ₀ (lbs)	T ₀ (lbs)			Oil	Grease						
9209	45.000	1.7717	85.000	3.3465	30.160	1.1875	1.00	0.040	2.197	5,300	5,223	6,893	9209TMT	9209SSTMT	-	-	-	6,700	-	-	
309	45.000	1.7717	100.000	3.9370	25.000	0.9843	1.50	0.060	3.781	8,367	11,895	11,665	309TMT	309SSTMT	-	309FFTMT	-	5,300	-	-	
9309	45.000	1.7717	100.000	3.9370	39.690	1.5625	1.50	0.060	3.781	8,367	11,895	11,665	9309TMT	9309SSTMT	-	-	-	5,300	-	-	
110	50.000	1.9685	80.000	3.1496	16.000	0.6299	1.00	0.040	1.828	4,699	4,642	5,351	110T	110SST	-	-	-	-	22,500	17,000	
210	50.000	1.9685	90.000	3.5433	20.000	0.7874	1.00	0.040	2.500	6,042	5,974	7,733	210T	-	-	-	-	-	20,000	17,000	
310	50.000	1.9685	110.000	4.3307	27.000	1.0630	2.00	0.080	4.500	10,006	14,225	13,661	310TMT	310SSTMT	-	310FFTMT	-	4,800	-	-	
9310	50.000	1.9685	110.000	4.3307	44.450	1.7500	1.00	0.040	4.500	10,006	14,225	13,661	9310TMT	9310SSTMT	-	9310FFTMT	-	4,800	-	-	
111	55.000	2.1654	90.000	3.5433	18.000	0.7807	1.00	0.040	2.297	5,826	6,387	6,719	111T	111SST	-	-	-	-	20,000	15,455	
211	55.000	2.1654	100.000	3.9370	21.000	0.8268	1.50	0.060	3.164	7,602	10,463	9,014	211TMT	-	-	-	-	5,500	-	-	
311	55.000	2.1654	120.000	4.7244	29.000	1.1417	2.00	0.080	5.281	11,794	16,950	15,796	311TMT	-	-	311FFTMT	-	4,400	-	-	
312	60.000	2.3622	130.000	5.1181	31.000	1.2205	2.00	0.080	6.125	13,721	19,407	18,064	312TMT	312SSTMT	-	-	-	4,000	-	-	
9312	60.000	2.3622	130.000	5.1181	53.975	2.1250	2.00	0.080	6.125	13,721	19,407	18,064	9312TMT	9312SSTMT	-	9312FFTMT	-	4,000	-	-	
313	65.000	2.5591	140.000	5.5118	33.000	1.2992	2.00	0.080	7.031	15,798	22,376	20,679	313T	313SST	-	313FFT	-	-	15,300	13,077	
313	65.000	2.5591	140.000	5.5118	33.000	1.2992	2.00	0.080	7.031	15,798	22,376	20,679	313TMT	313SSTMT	-	313FFTMT	-	3,700	-	-	
9313	65.000	2.5591	140.000	5.5118	58.740	2.3125	2.00	0.080	7.031	15,798	22,376	20,679	9313T	9313SST	-	9313FFT	-	-	15,300	13,077	
9313	65.000	2.5591	140.000	5.5118	58.740	2.3125	2.00	0.080	7.031	15,798	22,376	20,679	9313TMT	9313SSTMT	-	9313FFTMT	-	3,700	-	-	
314	70.000	2.7559	150.000	5.9055	35.000	1.3780	2.00	0.080	8.000	17,245	25,738	23,221	314TMT	314SSTMT	-	-	-	3,400	-	-	
9314	70.000	2.7559	150.000	5.9055	63.500	2.5000	2.00	0.080	8.000	17,245	25,738	23,221	9314TMT	9314SSTMT	-	-	-	3,400	-	-	
315	75.000	2.9528	160.000	6.2992	37.000	1.4567	2.00	0.080	9.031	19,537	18,282	25,930	315TMT	315SSTMT	-	-	-	3,200	-	-	
316	80.000	3.1496	170.000	6.6929	39.000	1.5354	2.00	0.080	9.031	20,885	29,145	26,083	316TMT	-	-	-	-	3,000	-	-	
317	85.000	3.3465	180.000	7.0866	29.000	1.6142	2.50	0.100	10.125	23,425	32,630	28,880	317TMT	-	-	-	-	2,800	-	-	
318	90.000	3.5433	190.000	7.4803	43.000	1.6929	2.50	0.100	11.281	26,110	36,375	31,481	318TMT	-	-	-	-	2,700	-	-	
320	100.000	3.9370	215.000	8.4646	47.000	1.8504	3.00	0.120	15.125	33,321	49,197	41,402	320TMT	-	-	-	-	2,400	-	-	
222	110.000	4.3307	200.000	7.8740	38.000	1.4961	2.00	0.080	12.656	24,088	64,445	33,120	222TMT	-	-	-	-	2,700	-	-	
322	110.000	4.3307	240.000	9.4488	50.000	1.9685	3.00	0.120	18.000	41,505	58,642	48,188	322TMT	-	-	-	-	2,200	-	-	
232	160.000	6.2992	290.000	11.4173	48.000	1.8898	3.00	0.120	20.797	52,653	70,435	49,990	232TMT	-	-	-	-	1,500	-	-	









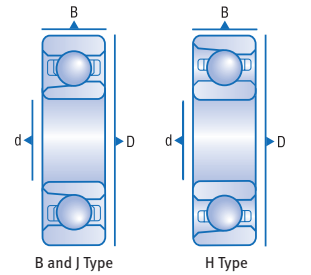

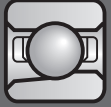

**Attainable speed is determined by cage, not lubricant type.

Angular Contact (Metric)

Bore Diameters: 3mm to 17mm

• Tolerances to a minimum of ABEC 7 (see pages 108 to 111)

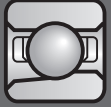





Basic Bearing Number	Bore Diameter		Outside Diameter		Width		Maximum Shaft/Housing Radius Which Bearing Corner Will Clear		Maximum Shaft/Housing Radius Which Bearing Corner Will Clear		Contact Angle	nd ²	Static Capacity		Basic Dynamic Load Rating	Bearing Nomenclature			Attainable Speeds (RPM)		
	d		D		B		r ₁ Max.		r ₂ Max. Non-Thrust Side				C ₀ (lbs)	T ₀ (lbs)		C (lbs)				Oil	Grease
	mm	inch	mm	inch	mm	inch	mm	inch	mm	inch											
2M3BY3	3.000	0.1181	10.000	0.3937	4.000	0.1575	0.15	0.006	0.15	0.006	20°	0.0273	67	107	289		-	-	315,000	230,000	
34H	4.000	0.1575	16.000	0.6299	5.000	0.1969	0.30	0.012	0.13	0.005	12°	0.1250	107	116	326	-	-	34H	183,000	140,000	
34BX4	4.000	0.1575	16.000	0.6299	5.000	0.1969	0.30	0.012	0.13	0.005	15°	0.9380	33	41	209		-	-	183,000	140,000	
34-5	5.000	0.1969	16.000	0.6299	5.000	0.1969	0.30	0.012	0.13	0.005	14°	0.9380	47	72	197		-	34-5H	183,000	140,000	
19M5BY1	5.000	0.1969	13.000	0.5118	4.000	0.1575	0.15	0.006	0.15	0.006	25°	0.4300	27	57	106		-	-	200,000	140,000	
36H	6.000	0.2362	19.000	0.7480	6.000	0.2362	0.30	0.012	0.13	0.005	15°	0.1582	145	173	419	-	-	36H(JB)	250,000	166,600	
36BX1	6.000	0.2362	19.000	0.7480	6.000	0.2362	0.30	0.012	0.13	0.005	11°	0.1187	44	53	270		-	-	162,000	105,000	
37H	7.000	0.2756	22.000	0.8661	7.000	0.2756	0.30	0.012	0.13	0.005	14°	0.2197	206	304	557	-	-	37H(JB)	132,000	85,800	
38H	8.000	0.3150	22.000	0.8661	7.000	0.2756	0.30	0.012	0.25	0.010	14°	0.2197	206	304	557	-	-	38H(JH)	132,000	85,800	
38BX2	8.000	0.3150	22.000	0.8661	7.000	0.2756	0.30	0.012	0.13	0.005	15°	0.1709	97	140	448		-	-	88,000	57,000	
39H	9.000	0.3543	26.000	1.0236	8.000	0.3150	0.30	0.012	0.25	0.010	15°	0.3164	434	607	1,006	-	-	39H(JB)	132,000	85,800	
100H	10.000	0.3937	26.000	1.0236	8.000	0.3150	0.30	0.012	0.25	0.010	15°	0.3164	532	607	1,199	-	-	100H(JH)	150,000	100,000	
200H	10.000	0.3937	30.000	1.1811	9.000	0.3543	0.64	0.025	0.38	0.015	15°	0.4307	913	727	1,567	-	-	200H(JB)	150,000	100,000	
1901H	12.000	0.4724	24.000	0.9449	6.000	0.2362	0.30	0.012	0.15	0.006	15°	0.2686	627	884	1,007	-	-	1901H(JH)	125,000	83,300	
101H	12.000	0.4724	28.000	1.1024	8.000	0.3150	0.30	0.012	0.25	0.010	15°	0.3516	623	701	1,309	-	-	101H(JH)	125,000	83,300	
101BX48	12.000	0.4724	28.000	1.1024	8.000	0.3150	0.30	0.012	0.25	0.010	15°	0.3516	522	779	1,030		-	-	125,000	83,300	
201H	12.000	0.4724	32.000	1.2598	10.000	0.3937	0.64	0.025	0.38	0.015	15°	0.3867	850	1,153	1,338	-	-	201H(JH)	125,000	83,300	
301H	12.000	0.4724	37.000	1.4567	12.000	0.4724	1.00	0.040	0.50	0.020	15°	0.6350	1,264	1,989	2,229	-	-	301H(JH)	125,000	62,500	
1902H	15.000	0.5906	28.000	1.1024	7.000	0.2756	0.30	0.012	0.15	0.006	15°	0.3418	851	1,167	1,181	-	-	1902H(JH)	100,000	66,600	
102H	15.000	0.5906	32.000	1.2598	9.000	0.3543	0.30	0.012	0.25	0.010	15°	0.3867	929	967	1,404	-	-	102H(JB)	100,000	66,600	
102BX48	15.000	0.5906	32.000	1.2598	9.000	0.3543	0.30	0.012	0.25	0.010	15°	0.3867	608	880	1,115		-	-	100,000	66,600	
102BJJX6	15.000	0.5906	32.000	1.2598	9.000	0.3543	0.30	0.012	0.25	0.010	15°	0.3515	620	1,180	1,321	-		-	100,000	66,600	
202H	15.000	0.5906	35.000	1.3780	11.000	0.4331	0.64	0.025	0.38	0.015	15°	0.6250	1,370	1,090	2,175	-	-	202H(JB)	100,000	66,600	
302H	15.000	0.5906	42.000	1.6535	13.000	0.5118	1.00	0.040	0.50	0.020	15°	1.0635	2,129	3,260	3,439	-	-	302H(JH)	100,000	50,000	
103H	17.000	0.6693	35.000	1.3780	10.000	0.3937	0.30	0.012	0.25	0.010	15°	0.4570	885	870	1,567	-	-	103H(JH)	88,200	58,800	
103BX48	17.000	0.6693	35.000	1.3780	10.000	0.3937	0.30	0.012	0.25	0.010	15°	0.4570	741	1,299	1,250		-	-	88,200	58,800	
203H	17.000	0.6693	40.000	1.5748	12.000	0.4724	0.64	0.025	0.38	0.015	15°	0.7056	1,593	2,353	2,452	-	-	203H(JH)	88,200	58,800	
303H	17.000	0.6693	47.000	1.8504	14.000	0.5512	1.00	0.040	0.50	0.020	15°	1.1816	2,506	3,731	3,801	-	-	303H(JH)	88,200	44,100	

Angular Contact (Metric)

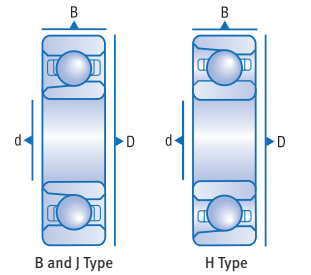
Bore Diameters: 20mm to 50mm

• Tolerances to a minimum of ABEC 7 (see pages 108 to 111)

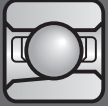

Basic Bearing Number	Bore Diameter		Outside Diameter		Width		Maximum Shaft/Housing Radius Which Bearing Corner Will Clear		Maximum Shaft/Housing Radius Which Bearing Corner Will Clear		Contact Angle	nd ²	Static Capacity		Basic Dynamic Load Rating	Bearing Nomenclature			Attainable Speeds (RPM)		
	d		D		B		r ₁ Max.		r ₂ Max. Non-Thrust Side				C ₀ (lbs)	T ₀ (lbs)		C (lbs)				Oil	Grease
	mm	inch	mm	inch	mm	inch	mm	inch	mm	inch											
104H	20.000	0.7874	42.000	1.6535	12.000	0.4724	0.64	0.025	0.38	0.015	15°	0.6875	1,287	1,413	2,358	-	-	104HJH	75,000	50,000	
104BX48	20.000	0.7874	42.000	1.6535	12.000	0.4724	0.64	0.025	0.38	0.015	15°	0.6875	1,078	1,976	1,870	104BX48	-	-	75,000	50,000	
204H	20.000	0.7874	47.000	1.8504	14.000	0.5512	1.00	0.040	0.50	0.020	15°	0.9766	2,214	2,037	3,283	-	204JJ	204HJH	75,000	50,000	
304H	20.000	0.7874	52.000	2.0472	15.000	0.5906	1.00	0.040	0.50	0.020	15°	1.4854	3,069	4,614	4,726	-	-	304HJB	75,000	37,500	
1905H	25.000	0.9843	42.000	1.6535	9.000	0.3543	0.30	0.012	0.25	0.010	15°	0.7656	1,954	2,664	2,356	-	-	1905HJH	60,000	40,000	
105H	25.000	0.9843	47.000	1.8504	12.000	0.4724	0.64	0.025	0.38	0.015	15°	0.8125	2,035	1,967	2,630	-	-	105HJH	60,000	40,000	
105BX48	25.000	0.9843	47.000	1.8504	12.000	0.4724	0.64	0.025	0.38	0.015	15°	0.8125	1,331	2,801	2,090	105BX48	-	-	60,000	40,000	
205H	25.000	0.9843	52.000	2.0472	15.000	0.5906	1.00	0.040	0.50	0.020	15°	1.0742	2,569	2,298	3,524	-	-	205HJB	60,000	40,000	
305H	25.000	0.9843	62.000	2.4409	17.000	0.6693	1.00	0.040	0.50	0.020	15°	2.1973	4,170	6,740	6,635	-	-	305HJB	60,000	30,000	
106H	30.000	1.1811	55.000	2.1654	13.000	0.5118	1.00	0.040	0.50	0.020	15°	1.1074	3,369	2,216	3,392	-	-	106HJH	50,000	33,300	
106BX48	30.000	1.1811	55.000	2.1654	13.000	0.5118	1.00	0.040	0.50	0.020	15°	1.1074	1,843	3,103	2,715	106BX48	-	-	50,000	33,300	
206H	30.000	1.1811	62.000	2.4409	16.000	0.6299	1.00	0.040	0.50	0.020	15°	1.8154	4,217	5,982	5,634	-	-	206HJH	50,000	33,300	
306H	30.000	1.1811	72.000	2.8346	19.000	0.7480	1.00	0.040	0.50	0.020	15°	2.8223	6,086	8,966	8,378	-	-	306HJH	50,000	25,000	
1907H	35.000	1.3780	55.000	2.1654	10.000	0.3937	0.64	0.025	0.38	0.015	15°	1.1875	3,156	4,227	3,299	-	-	1907HJH	42,800	28,500	
107H	35.000	1.3780	62.000	2.4409	14.000	0.5512	1.00	0.040	0.50	0.020	15°	1.4648	3,750	5,087	4,300	-	-	107HJB	42,800	28,500	
107BX48	35.000	1.3780	62.000	2.4409	14.000	0.5512	1.00	0.040	0.50	0.020	15°	1.4648	2,451	4,093	3,430	107BX48	-	-	42,800	28,500	
207H	35.000	1.3780	72.000	2.8346	17.000	0.6693	1.00	0.040	0.50	0.020	15°	2.2969	5,490	5,543	6,849	-	-	207HJH	42,800	28,500	
307H	35.000	1.3780	80.000	3.1496	21.000	0.8268	1.50	0.060	0.76	0.030	15°	3.4805	7,738	11,271	10,010	-	-	307HJH	42,800	21,400	
108H	40.000	1.5748	68.000	2.6672	15.000	0.5906	1.00	0.040	0.50	0.020	15°	1.6602	4,360	4,221	4,614	-	-	108HJH	37,500	25,000	
108BX48	40.000	1.5748	68.000	2.6772	15.000	0.5906	1.00	0.040	0.50	0.020	15°	1.6602	2,848	6,047	3,685	108BX48	-	-	37,500	25,000	
208H	40.000	1.5748	80.000	3.1496	18.000	0.7087	1.00	0.040	0.50	0.020	15°	2.6367	6,386	9,008	7,750	-	-	208HJH	37,500	25,000	
308H	40.000	1.5748	90.000	3.5433	23.000	0.9055	1.50	0.060	0.76	0.030	15°	1.0742	9,679	13,981	12,152	-	-	308HJH	37,500	18,800	
109H	45.000	1.7717	75.000	2.9528	16.000	0.6299	1.00	0.040	0.50	0.020	15°	2.2500	5,805	7,841	6,209	-	-	109HJH	33,300	22,200	
209H	45.000	1.7717	85.000	3.3485	19.000	0.7480	1.00	0.040	0.50	0.020	15°	2.8564	7,087	7,073	8,155	-	-	209HJB	33,300	22,200	
309H	45.000	1.7717	100.000	3.9370	25.000	0.9843	1.50	0.060	0.76	0.030	15°	5.1992	11,714	16,940	14,416	-	-	309HJH	33,300	16,700	
110H	50.000	1.9685	80.000	3.1496	16.000	0.6299	1.00	0.040	0.50	0.020	15°	2.5313	6,653	8,917	6,658	-	-	110HJH	30,000	20,000	
110BX48	50.000	1.9685	80.000	3.1496	16.000	0.6299	1.00	0.040	0.50	0.020	15°	2.5313	4,346	9,227	5,325	110BX48	-	-	30,000	20,000	
210H	50.000	1.9685	90.000	3.5433	20.000	0.7874	1.00	0.040	0.50	0.020	15°	3.5000	8,703	8,712	9,261	-	-	210HJH	30,000	20,000	

Special Applications



Introduction

Our special bearing innovations range from nearly standard bearings with slightly modified dimensions, to intricate assemblies which integrate the bearing function into a complete mechanism. Barden engineers work closely with customers to develop unique bearing designs with specialized features to meet application requirements and solve functional problems.

In many cases the overall cost of a piece of equipment can be reduced by incorporating special or customised bearings, particularly when mating components are integrated into the bearing. Such components include mounting flanges, gear teeth, spring carriers and integral O-ring grooves. The performance and installation benefits gained from using individually designed bearings include:

- IMPROVED ASSEMBLY RELIABILITY.
- ENHANCED RIGIDITY OR STABILITY OF THE SYSTEM.
- BETTER LOCATION CONTROL THROUGH PROPER BEARING ORIENTATION.
- REDUCTION IN HANDLING OPERATIONS AND CONTAMINATION.
- IMPROVED ALIGNMENT OF THE ROTATING ASSEMBLY.
- WEIGHT REDUCTION.
- IMPROVED RESISTANCE TO TEMPERATURE EXTREMES.
- REDUCTION IN TOLERANCE STACK-UP.

Capabilities

- VACUUM PUMPS.
 - TURBOMOLECULAR PUMPS. PG44
 - DRY PUMPS. PG44
- TOUCHDOWN BEARINGS. PG45
- MEDICAL & DENTAL.
 - HIGH SPEED DENTAL HANDPIECE BEARINGS. PG46
 - X-RAY. PG48
- AVIATION & DEFENSE.
 - AUXILIARY EQUIPMENT. PG50
 - INSTRUMENTATION & SENSING. PG52
 - ACTUATION SYSTEMS. PG54
- CANNING INDUSTRY. PG56
- NUCLEAR POWER. PG57
- EMERGING AUTOMOTIVE TECHNOLOGIES. PG58
- THRUST WASHERS. PG60

Special Applications

Vacuum Pumps

Barden has established an expertise in developing bearings for the entire pump market. Using new materials — and by adding value — bearings can be designed to meet the harsh requirements of today’s high performance pump market.

Some of the factors that make high precision bearings the first choice are high temperatures, high speeds, low vibration levels, abnormal contamination levels, poor lubrication, high reliability and long life.

Among the areas of expertise in which Barden bearings are already proven as the solution provider are turbomolecular pump bearings, dry pump bearings and emergency touch down bearings for magnetically supported pumps.

Turbomolecular Pumps

The most important requirements for a bearing used in this application are long life, reliability and high-speed performance. To this end the use of X-life Ultra bearings, ceramic balls, greased for life and special high quality raceway finishes has become the Barden standard. Current “greased-for life” bearing technology can consistently give 30,000+ hour life at speeds in excess of 1 million ndm.

Dry Pump Bearings

While the speed requirements on the bearings for this type of application are often lower than usual, other factors including temperature, contamination and reliability mean that a special bearing design is necessary in order to meet the application requirements. Barden is able to design dry pump bearings for optimal performance with both oil and grease lubrication. Also, by adding value to the bearing so that it reduces assembly cost and pump component count, additional performance and economic benefits can be gained from the use of Barden’s special bearings.

Special design features

Some of the value-added design features that enable Barden’s special bearings to work reliably in high-performance pumping applications include:

- **CRONIDUR 30® HIGH-NITROGEN STEEL – FOR OPTIMUM PERFORMANCE AND RELIABILITY.**
- **HIGH PERFORMANCE CERAMIC BALLS – CHOSEN TO MEET THE PERFORMANCE AND CORROSION REQUIREMENTS.**
- **HIGH-SPEED SMALL BALL TECHNOLOGY – FOR IMPROVED PUMPING SPEEDS.**
- **SHIELDED ANGULAR CONTACT DESIGN – TO GUARD AGAINST CONTAMINATION INGRESS AND PROLONG LUBRICANT LIFE.**
- **SPECIAL INTERNAL DESIGN – TO MAXIMIZE THE IN-APPLICATION PERFORMANCE.**
- **SPECIAL BARDEN “TMP STANDARD” INTERNAL FINISH – FOR QUIETER RUNNING, LONGER LIFE AND HIGH RELIABILITY.**

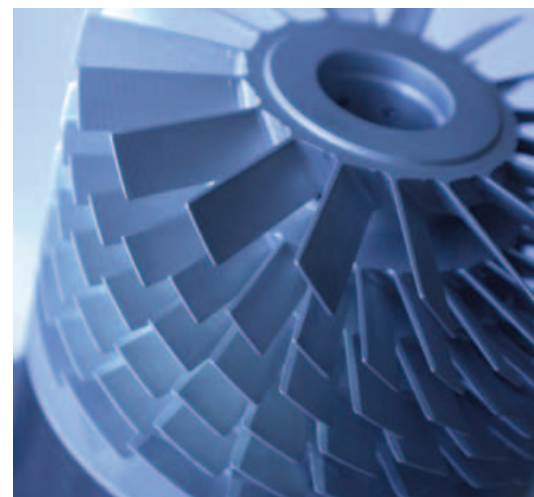

Vacuum pump bearings must endure a range of hostile operating conditions, an environment ideally suited for Barden precision bearings.

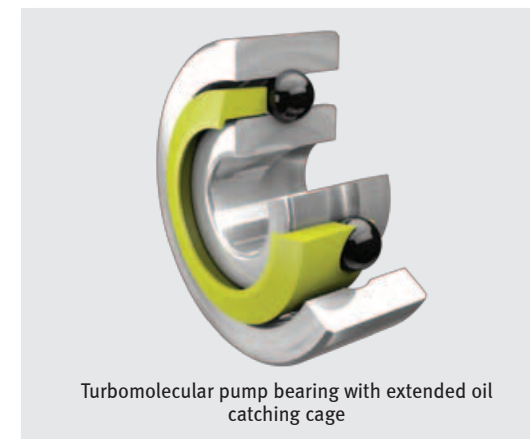

Turbomolecular pump bearing with extended oil catching cage

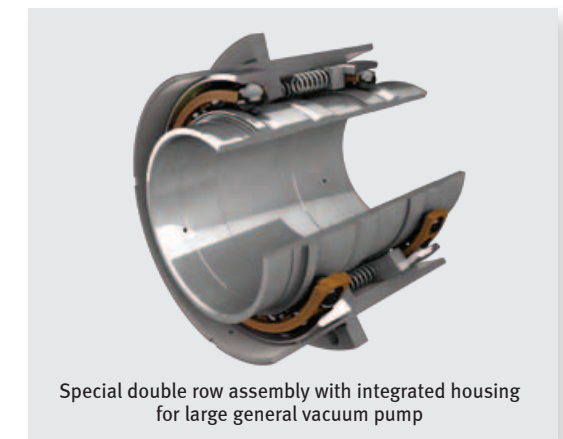

Special double row assembly with integrated housing for large general vacuum pump



Special heavy section inner ring ceramic bearing for a high performance dry pump

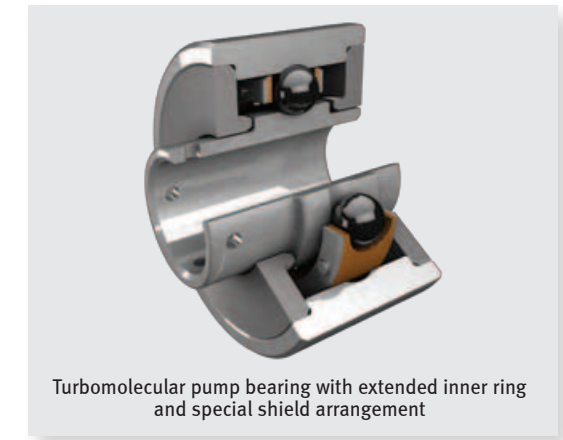

Turbomolecular pump bearing with extended inner ring and special shield arrangement

Emergency Touchdown/Auxiliary Bearings

Active magnetic bearing systems provide a practical method of suspending shafts (both axially and radially) in numerous applications, including turbomolecular vacuum pumps, dry pumps, compressors, blowers, air conditioning systems, gas expanders and in energy storage systems as emergency back up power. Barden has a dedicated engineering team specializing in the emergency touchdown bearings that typically accompany the above systems.

This special application area requires bearings that can withstand the harshest conditions. To successfully control a shaft on which the magnetic bearings have failed often requires a bearing that can accelerate from zero to 2 million dN or higher virtually instantaneously. In addition the bearing system must then control the rotor under the very high radial, axial and shock loading. Barden has developed bearings for this application using a “full of balls” ceramic design with Cronidur 30® rings to give exceptional performance and corrosion resistance. Barden is able to optimize the bearing design for the maximum number of touchdowns.

Our engineers are able to closely predict the initial shock load characteristics during the crucial first phase of operations and therefore size the touchdown bearing more appropriately.

This means an emergency bearing design is not over-engineered or under-engineered for a given application. Touchdown bearings have been developed in numerous configurations, including single and double bearing arrangements.

Designs range from units that fit 4mm diameter shafts up to 200mm diameter versions. For particularly harsh environments such as aggressive gases, the bearings use zirconia balls for extra corrosion resistance.

Barden’s Product Engineering Department is able to offer further advice on touchdown bearings for industrial applications by request.



Typical full complement hybrid ceramic pair of bearings for emergency touchdown application

Special Applications

Medical & Dental

High Speed Dental Handpiece Bearings

For over 35 years the Barden Corporation has been developing and manufacturing super precision bearings for high speed dental handpiece applications, in both the OEM and replacement markets.



The severe demands of mixed friction conditions found in dental handpieces make Barden bearings the ideal choice.

As arguably one of the most arduous applications for precision bearings, handpiece turbines operate at speeds up to 500,000 rpm and are subjected to repeated sterilization cycles.

All Barden dental bearings have super finished raceways with strict controls on roundness, harmonic amplitudes and lobing patterns. All assembly, test and packing operations are carried out in clean room conditions.

Barden dental bearings are available in both deep groove and angular contact configurations. They can be supplied with or without shields for lubricant retention and contamination exclusion. Some types are available with flanged or stepped outer ring OD's for O-ring location. A range of cage materials are available for sterilization resistance, including Torlon and Phenolic.

For certain markets bearings can be supplied with Silicon Nitride ceramic balls, offering the advantage of lower centrifugal ball loads at the high rotational speed of the turbine. These lower loads produce less stress between the balls and the cage and as such, cages will generally withstand a greater number of sterilization cycles than bearings with steel balls. Consequently, operational life and reliability are increased.

All Barden dental bearings are supplied ready to use with a controlled quantity of grease lubrication specially developed for this application. As with all Barden products, full technical support is provided for this product line by a team of specialist engineers using a laboratory equipped with run test fixtures. These include vibration and speed monitoring, sterilization equipment and full resources to complete bearing examinations of all types.

Some examples of the Barden dental bearing range are shown on the following page. Other variants are available. More information is available from Barden's Product Engineering Department.



All Barden precision bearings are assembled under stringent cleanroom conditions.

High Speed Dental Handpiece Bearings - Examples

Angular contact



Deep groove

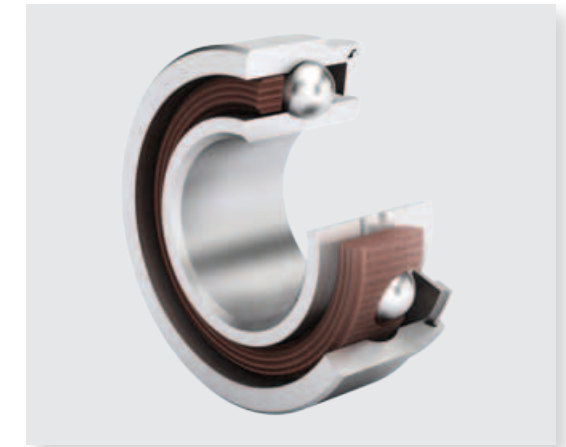

J type



Custom design

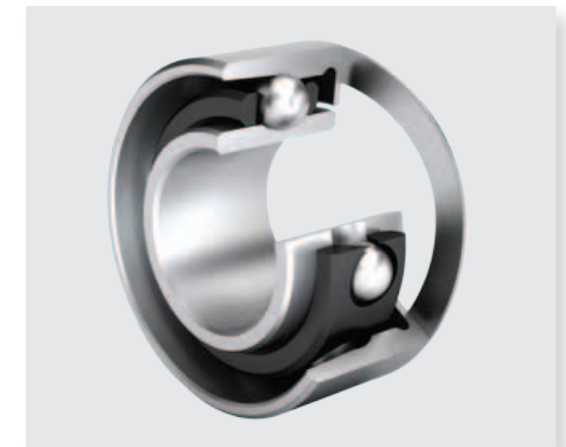

Special Applications

Medical & Dental

X-Ray

Barden continues to keep pace with advances in X-ray and medical scanning technology with new, improved X-ray tube bearing designs. These bearings, which are used to support the spinning X-ray anode, operate at speeds in excess of 10,000 rpm under harsh conditions. In addition to withstanding the passage of high voltage, the bearing must also operate in a vacuum environment down to 10⁻⁸ torr and at temperatures of 400–500°C (750–900°F).

Barden X-ray cartridge bearings are full ball complement designs, incorporating a flanged shaft with integral races to which the target anode is attached. A separate flange made of lower thermal conductivity material can be welded to the shaft in order to reduce heat transfer from the anode. The bearings are built with controlled axial clearance in order to compensate for thermal

growth at the operating temperature. Conventional outer rings are separated by spacers with either solid or spring preloading that is designed to meet specific application requirements.

In order to provide effective lubrication under these extreme conditions, Barden utilizes advanced surface engineering technologies such as plasma and ion-beam assisted deposition. Working closely with specialist organizations in these fields, Barden is developing a range of advanced solid lubricants some 2000 times thinner than the human hair to complement its high-temperature X-ray bearing materials.

With the emphasis on improved patient care resulting from faster data acquisition and high resolution imagery, Barden precision bearings provide a clear choice for advanced X-ray and medical scanner applications.



Barden super precision x-ray bearings enable medical scanner applications to provide images of the highest resolution.



Designed to operate under high vacuum at elevated temperatures, Barden bearings are an integral part of high-speed x-ray tubes.

X-Ray

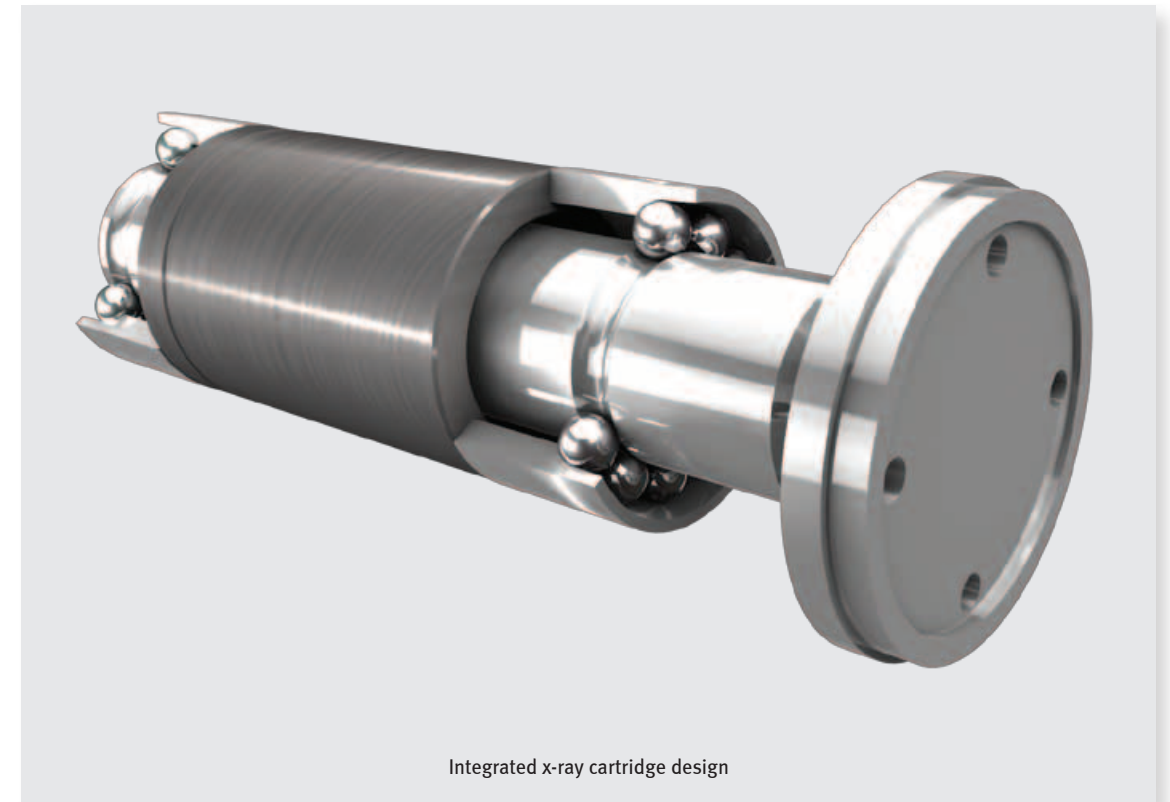

Integrated x-ray cartridge design

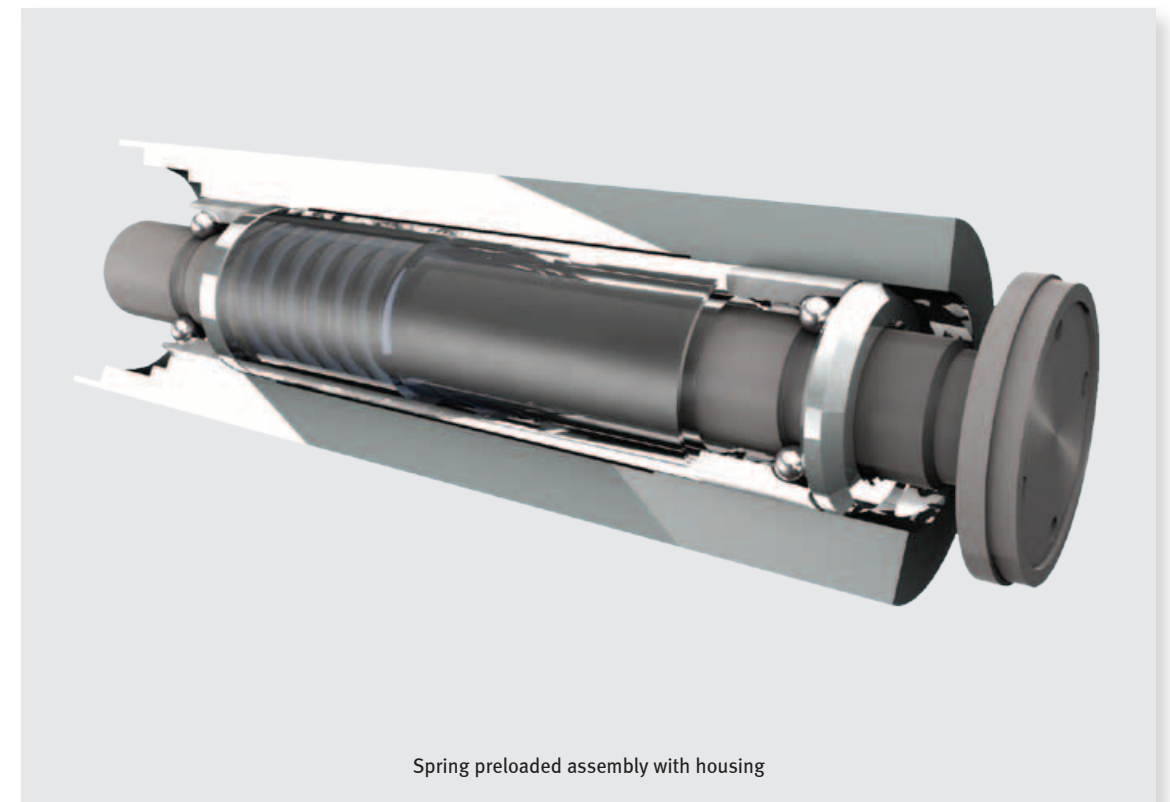

Spring preloaded assembly with housing

Special Applications

Aviation & Defense

Auxilliary Equipment

Custom designed and manufactured aerospace bearings are a cornerstone of the Barden product line. Aerospace bearings are specifically designed according to application requirements, with engineering staff often involved early in the development stages of aerospace equipment.

Barden bearings are utilized in pneumatic and electric starters and generators, gearboxes, and a variety of auxiliary aircraft positions. Bearing configurations range from standard deep groove bearings to intricate split inner ring designs. Thanks to state-of-the-art production facilities and a highly

experienced workforce, The Barden Corporation is able to manufacture bearings with unusual materials and designs.

Unlike the product designs which vary, product precision remains constant. Super precision ABEC 7 bearings are standard, and as a result Barden aerospace bearings are capable of high speed, reliable operation and quiet running with minimum power losses.

Due to their unique design, split inner configurations can accept reversing thrust and combination loads. The bearings are assembled with one-piece high

strength cages that are often silver plated for improved operation under marginal lubrication conditions. Bearing configurations can include puller grooves and flanges, as required. Typically split inner ring bearings are manufactured from high temperature, high strength bearing steels

such as AISI M50 and Cronidur 30[®]. As in other applications, ceramic balls are available and can enable higher speed operation.

Other typical aerospace configurations include deep groove bearings which are greased and sealed for life at the factory in clean assembly rooms. A variety of grease lubricants are available depending on

the application requirements. Barden “T” cages are often recommended for these bearings. In addition to being lightweight and strong, “T” cages allow for high speed bearing operation. The standard high temperature seal material is Viton. This material is generally not reactive with typical chemicals present in aerospace applications.

Barden Flexeals are also available when higher operating speeds are required. Cronidur 30[®] rings and ceramic balls are often recommended to provide corrosion protection for bearings operating in harsh environments.



Specialty bearings include the flanged split inner ring configuration, shown here, used in precision aerospace applications.

Auxilliary Equipment



Deep groove bearing with two-piece machined and riveted metallic cage



Angular contact bearing with full ball complement



Wide width, deep groove bearing with light contacting seals



Gothic arch ball bearing with flange and securing holes for aircraft generator application

Special Applications

Aviation & Defense

Instrumentation & Sensing

For over 65 years the Barden Corporation has been offering precision gyro bearing users an extremely wide range of special design bearings and assemblies. Increased performance requirements of gyros in terms of drift rate, life and size have created a demand for bearings produced to carefully controlled tolerances of less than half a micrometre. This accuracy, plus close control of contact surface geometry and finish, cleanliness and ball retainer oil impregnation, results in a number of benefits:

- **DECREASED VIBRATION LEVELS.**
- **LONGER USEFUL LIFE WITH FEWER LUBRICATION FAILURES.**
- **GREATER STABILITY OF PRELOAD.**
- **REDUCED MASS SHIFT DUE TO WEAR.**
- **GREATER PERFORMANCE UNIFORMITY FROM UNIT TO UNIT.**

These improvements are accomplished by means of unusually close control of raw materials, metallurgy, geometry, runout errors, and all critical dimensions.

Barden can offer many bearing types ranging from conventional bearings with modified dimensions to intricate configurations designed to meet unusual performance or application problems. Many special assemblies include shaft or housing members designed integrally with bearing inner or outer rings to reduce mating part errors and tolerance build-up, or to simplify component design and assembly. Such integrated designs have enabled gyro manufacturers to greatly improve the performance of their units, often with an overall reduction in production costs.

Optical Systems

Super precision bearings play a crucial role in ensuring the accuracy and reliability of optical guidance systems used in military sensing applications. Advanced infrared seeker systems used in modern military equipment often utilize bearings to support intricate mirror gimbal arrangements. Commercial optical applications include gyro stabilised camera systems which are used to acquire good quality images and video footage typically from a moving vehicle.

Barden engineers design gimbal bearings for optical systems to have certain key characteristics which are vital for the accuracy and effectiveness of the system. Specifically this includes the radial and axial stiffness of the bearing, friction torque level and lubrication method.



The unique demands placed on gyros makes Barden precision bearings the only option.



Rotor bearings are made to precision tolerances for optimum performance.



Gimbal bearings are offered in a wide range of design configurations to fit a variety of special needs.

Instrumentation & Sensing

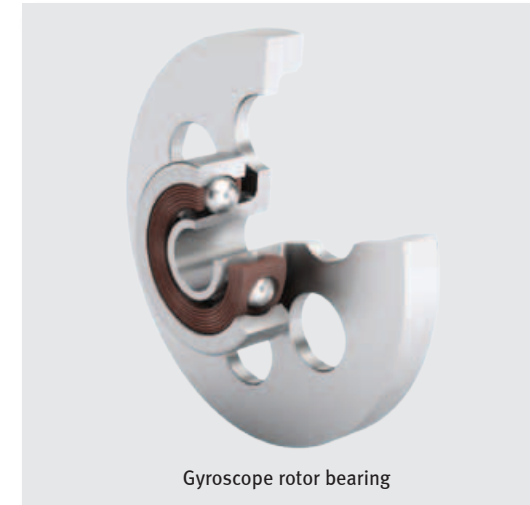

Gyroscope rotor bearing



Optical system pivot bearing



Gyroscope end bell rotor bearing



Guidance system gimbal duplex pair



Gyroscope gimbal duplex pair

Special Applications

Aviation & Defense

Actuation Systems

With decades of experience in designing fully optimized and integrated bearings and assemblies for aircraft equipment, Barden can deliver high performance solutions for commercial and defense actuation systems, including primary and secondary flight control for military and civil aircraft, satellite and missile applications.

Typically super precision bearings are utilized in equipment including conventional servo-controls, fly-by-wire and power-by-wire actuation and electro-hydraulic actuation. Standard applications include rudder, elevator and aileron flight control systems.

As aerospace experts, Barden engineers have designed bearing assemblies for a wide range of challenging actuation applications. For example, where bearings are local to the point of actuation, high vibration levels can be expected. The incorporation of dissimilar ball and race materials (e.g. ceramic balls) can lead to reduced adhesive wear during vibrational or non-operational duty cycles.

Barden engineers can create customised internal designs to maximize load carrying capacity and stiffness. Where design envelopes are small, Barden can engineer a range of solutions aimed at easing the assembly process and reduce assembly time. In previous actuator applications this has included the incorporation of screw threads on assembly mating surfaces and inclusion of components from the surrounding shaft and housing within the bearing design. Such features can potentially lead to cost savings over the entire assembly and reduced assembly time.

Bearings for these systems can include a number of further optimizing features. Designs can be produced which incorporate:

- **SEALING TECHNOLOGY WITHIN THE BEARING TO HELP SAVE SPACE.**
- **ABILITY TO WITHSTAND VERY HIGH LOADS.**
- **OPERATION UNDER BOUNDARY LUBRICATION CONDITIONS.**
- **SUPER FINISHED RACEWAYS TO IMPROVE LUBRICATION FILM GENERATION.**
- **ANTI-ROTATION FEATURES TO PREVENT SLIPPAGE UNDER THE EFFECTS OF THE RAPID CHANGES IN SPEED AND DIRECTION OF ROTATION.**

Actuation Systems



Nose to body bearing, flanged with a threaded OD



Full complement bearing for a fin actuation system



Aircraft actuator motor bearing



Double row, full complement bearing for helicopter control rod application



Thin section bearing for an actuation system

Special Applications

Canning Industry

Canning was a revolutionary invention in the 19th century. It created a way to preserve fresh and cooked food for years, maintaining nutritional value and without requiring chemical additives or processes such as smoking, pickling or salting.

All phases of can forming, shaping and seaming rely on rolling element bearings for continued accuracy and speed of process. Can making and canning are now high-speed, high technology industries.

Cans can be manufactured at rates of more than 1,500 per minute, and printed and filled at similar speeds. Barden super precision angular contact ball bearings can be found in machinery that services the high and low volume canning industries.

This industry presents a particularly hostile environment for bearings. In addition to aggressive media and harsh cleaning processes, bearing lubricants must also comply with environmental (FDA) guidelines that require the use of thin organic-based oils offering only marginal lubrication characteristics for the majority of the operation.



Barden's specialized bearings set the standard for performance and reliability in the high volume throughput canning industry.

The use of ceramic balls in this application offers many benefits, including the extreme reduction in surface (adhesive) wear compared to conventional bearings. Wear particles generated by adhesive wear are not present in ceramic hybrid bearings and as such, lubricant life is extended and lubrication intervals increased. This extension is also aided by the lower temperatures at which ceramic hybrid bearings operate.

By combining the material properties of advanced corrosion-resistant steels with those of ceramic balls, Barden bearings demonstrate superior performance and reliability over traditional steel bearings in this demanding environment.

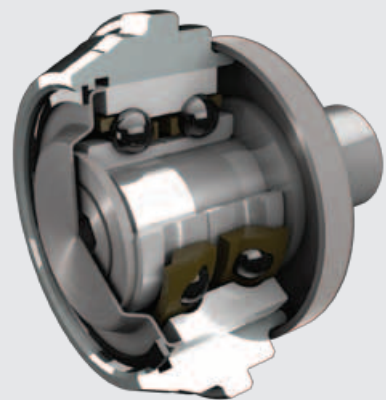

Seamer tool assembly



Hybrid ceramic, seamer bearing

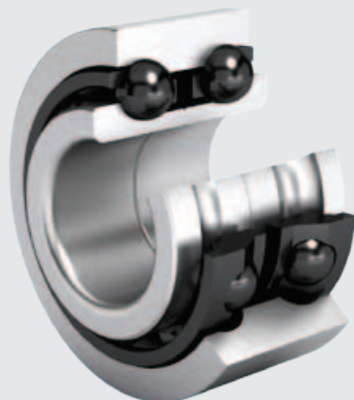

Double row, hybrid ceramic seamer bearing cartridge

Nuclear Power

In safety-critical applications such as nuclear power plants, component obsolescence is a critical factor in supplier selection. For more than 60 years, Barden has been manufacturing super precision bearings for the nuclear industry worldwide and has a policy of non-obsolescence.



In nuclear power stations, Barden super precision bearings are often found in the fuel handling systems and linear actuation systems that position the control rods into the nuclear fuel bundle. In emergency situations, these control rods are dropped into the fuel bundle in order to absorb the reactor heat. This means that component reliability is critical and the bearings must not fail under any circumstances. Barden therefore provides certification, full traceability, controlled lubrication and retention of records for every bearing supplied to the nuclear industry.

Barden produces bearings for all generations of nuclear reactors, including pressurised water reactors (PWR and VVER), boiling water reactors (BWR), pressurised heavy water reactors (CANDU), gas-cooled reactors (Magnox, AGR, UNGG), and light water graphite reactors (RBMK). Barden is also actively involved in developing bearings for next generation nuclear reactors.

Barden is able to produce direct replacement bearings to the same or higher quality standards as the original, and is also able to manufacture these bearings in small batch sizes, anything from 10 to 500 units. Most bearings for nuclear applications range from 20mm up to 240mm in diameter and

are of the deep groove ball bearing and angular contact ball bearing types. Some special applications require thin section duplex bearings.

Barden's UK and US-based manufacturing plants also provide full clean room facilities, which guarantee contaminant-free assembly of bearings.

Special materials and coatings to suit the application or extreme environments can be used, with bearings available in SAE 52100, AISI 440C, Cronidur 30[®] (high corrosion resistance and high temperature operation), AISI M50 and BG42. Balls can be manufactured from ceramic silicon nitride,

zirconium dioxide, tungsten carbide or cast cobalt alloy. Cage materials can be specified in steel, bronze, phenolic, polyamide, polyimide, PEEK or PTFE-based. Lubricants used include hydrocarbon, synthetic esters and hydrocarbons, silicone and perfluoroalkylpolyether and special nuclear greases such as Castrol Nucleol.



Deep groove, shielded bearing with a special flange for a nuclear application

Special Applications

Emerging Automotive Technologies

At its UK and US sites, Barden engineers are at the forefront of the latest developments in innovative, energy efficient, low friction, super precision ball bearings for emerging automotive technologies.

Turbochargers

In order to support the growing demand for more energy efficient, low carbon emission vehicles, particularly passenger cars and commercial vehicles, higher efficiency turbocharging systems that are both durable and affordable are required.

The advantages of ball bearing turbochargers over hydrostatic bearings stems from the fundamental change in the friction mechanism of the system, with rolling elements replacing a thin oil film in high shear. This results in an improvement in system friction at operating temperature. The 'ball bearing effect' is most pronounced at low engine speeds, just where a down-speeding or downsizing concept needs the most help from the turbocharger system. With ball bearing turbochargers, the charge air is available to the system immediately on cold start up, resulting in a more energy efficient system with reduced emissions.

Barden ball bearings for turbochargers typically utilize ceramic balls, metallic cages, and incorporate a series of oil flow controls for lubrication and squeeze film damping. These types of bearings rotate up to six times faster than any other vehicle bearing. In hot shutdown conditions, these bearings can also reach temperatures in excess of 400°C. The bearing is designed to be cooled by the oil flow, and the bearing materials must resist extreme conditions at all times.

Electronic superchargers and turbo compounding

For the latest trends in automotive technologies, Barden also offers bearing systems for electronic superchargers, used for charge air or cooling for fuel cells and for turbo compounding devices, such as in exhaust stream turbine generators. These types of bearings must provide stability, robustness, and are typically lubricated-for-life to provide maximum durability and reliability over the life of the fuel cell system.

Energy Recovery Systems

As well as thermal energy recovery systems such as turbochargers, Barden super precision ball bearings also play a vital role in the development of innovative kinetic energy recovery systems (KERs). Essentially large flywheels, these bearing systems accumulate energy from the kinematic motion of the vehicle or system. This recovered or 'free' energy is then utilized to power other systems or to restart the engine or vehicle from its stationary position.

Barden works closely with a wide variety of companies using these same principles, including manufacturers of elevators, lifting gear and cranes, through to public transport systems such as buses, trains and trams. Most of these bearings are of the angular contact ball bearing type, designed for low friction operation. These systems typically operate in vacuums which draws on a key area of Barden expertise.

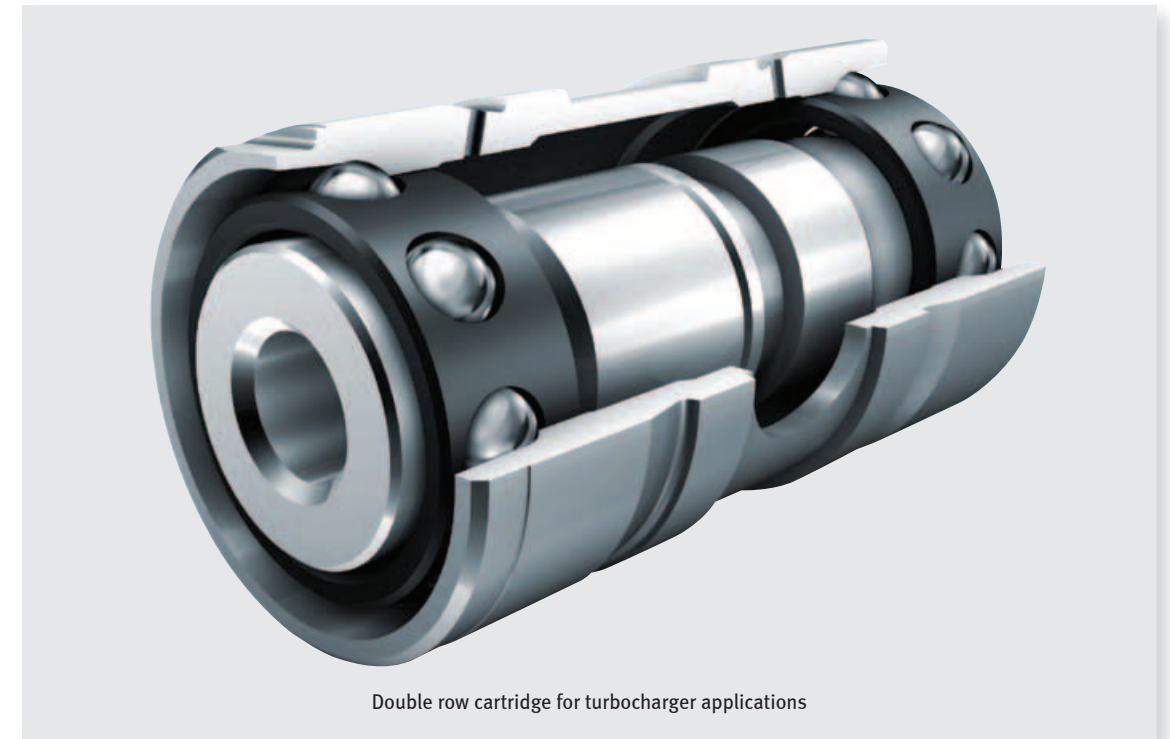

Double row cartridge for turbocharger applications



Corrosion resistant, high speed bearing solution for turbine generators



Double row cartridge for KERs application

Special Applications

Thrust Washers

In addition to the deep groove and angular contact bearings shown in this catalogue, Barden are also able to produce thrust washers for supporting high axial loads under low to moderate speeds. These thrust washers have the bearing raceways machined into the face of the rings rather than the outer ring bore and inner ring OD allowing for very high contact angles to be attained, and with this, high axial load carrying capacities. These bearings however, are not suited to radial loads and should be used in conjunction with radial bearings.

Barden produces thrust washer bearings in various sizes up to 6 inches in diameter. They can be produced in a variety of configurations including, but not limited to, angular contact, double row and split washers.

Material options for Barden thrust washers include:

Rings

- SAE 52100.
- AISI 440C.
- AISI M50.

Balls

- SILICON NITRIDE/CERAMIC.

Separators

- BRONZE OR PHENOLIC CAGES.
- CUSTOM SPACERS FROM A VARIETY OF MATERIALS.

The Barden Product Engineering Department is available to offer assistance with bearing design and all unique requirements.



Double row thrust washer bearing



Single row thrust washer bearing with ball spacers



Single row thrust washer bearing

Engineering



Table of Contents

Bearing Selection

Selecting the Right Bearing	64	Internal Design Parameters.....	81
Operating Conditions.....	64	Ball Complement	81
Bearing Types	65	Raceway Curvature	81
Diameter Series.....	66	Radial Internal Clearance	81 – 83
Sizes and Materials	66	Contact Angle	84 – 85
Ball & Ring Materials	66 – 67	Axial Play.....	86 – 87
Ceramic Hybrid Bearings	68 – 70	Ball Complement (Tables)	88 – 90
X-life Ultra Bearings.....	70	Preloading.....	91 – 95
Surface Engineering Technology	71 – 72	Lubrication	96 – 103
Solid Lubrication	72	Tolerances and Geometric Accuracy ...	104 – 105
Bearing Cages	73 – 77	Tolerance Tables	106 – 109
Bearing Closures	78 – 79		
Attainable Speeds & Limiting Speed Factors ..	80		

Bearing Performance

Bearing Life	110
Service Life.....	110
Bearing Capacity.....	110 – 111
Fatigue Life.....	112 – 115
Grease Life	116
Vibration	117
Yield Stiffness.....	118
Torque	118
Measurement and Testing.....	118 – 119

Bearing Application

Mounting and Fitting	120
Shaft & Housing Fits	121
Fitting Practice.....	121
Fitting Notes	122 – 123
Shaft & Housing Size Determination ..	123 – 124
Maximum Fillet Radii	124
Shaft & Housing Shoulder Diameters.....	125
Abutment Tables.....	126 – 134
Random and Selective Fitting.....	135
Calibration.....	135 – 136
Maintaining Bearing Cleanliness.....	137 – 138
Handling Guidelines	139
Index.....	140

Engineering

Bearing Selection

Selecting the Right Bearing

Selection of a suitable standard bearing — or the decision to utilize a special bearing — represents an effort to deal with performance requirements and operating limitations. Sometimes the task involves conflicts which must be resolved to reach a practical solution.

Making the right choice requires a careful review of all criteria in relation to available options in bearing design. Each performance requirement, such as a certain speed, torque or load rating, usually generates its own specifications which can be compared with available bearing characteristics.

When operating conditions and performance requirements have been formally established, each bearing considered should be reviewed in terms of its ability to satisfy these parameters. If a standard bearing does not meet the requirements, a design compromise will be necessary in either the assembly or the bearing.

At this point, the feasibility of a bearing design change (creation of a special bearing) should be explored with Barden's Product Engineering Department. Consideration of a special bearing should not be rejected out-of-hand, since it can pose an ideal solution to a difficult application problem

Operating Conditions

Operating conditions which must be considered in the selection process are listed in Table 1. This is a convenient checklist for the designer who must determine which items apply to a prospective application, their input values and often their relative importance. Performing this exercise is a useful preliminary step in determining what trade-offs are necessary to resolve the design conflicts.

Among the most important application considerations that must be evaluated are speed and load conditions.

Specific bearing design choices should be based on anticipated operating conditions. Design choices include:

- MATERIALS (RINGS AND BALLS).
- BEARING SIZE AND CAPACITY.
- INTERNAL DESIGN PARAMETERS.
- PRELOADING (DUPLEXING).
- TOLERANCES & GEOMETRIC ACCURACY.
- BEARING TYPE.
- CLOSURES.
- CAGES.
- LUBRICATION.

Bearing Types

Barden precision bearings are available in two basic design configurations: Deep groove and angular contact. Design selections between deep groove and angular contact bearings depend primarily upon application characteristics such as:

- MAGNITUDE AND DIRECTION OF LOADING.
- OPERATING SPEED AND CONDITIONS.
- LUBRICATION.
- REQUIREMENTS FOR ACCURACY AND RIGIDITY.
- NEED FOR BUILT-IN SEALING OR SHIELDING.

Bearing Size

A variety of criteria will have an influence on bearing size selection for different installations, as follows:

Mating parts. Bearing dimensions may be governed by the size of a mating part (e.g. shaft, housing).

Capacity. Bearing loading, dynamic and static, will establish minimum capacity requirements and influence size selection because capacity generally increases with size.

Attainable Speeds. Smaller bearings can usually operate at higher speeds than larger bearings, hence the speed requirement of an application may affect size selection.

Stiffness. Large bearings yield less than small bearings and are the better choice where bearing stiffness is crucial.

Weight. In some cases, bearing weight may have to be considered and factored into the selection process.

Torque. Reducing the ball size and using wider raceway curvatures are tactics which may be used to reduce torque.

Table 1. Basic operating conditions which affect bearing selection.

Load	Speed	Temperature	Environment	Shaft and Housing Factors
Direction <ul style="list-style-type: none"> • Radial • Thrust • Moment • Combined Nature <ul style="list-style-type: none"> • Acceleration (including gravity) • Elastic (belt, spring, etc.) • Vibratory Impact (shock) • Preload Duty Cycle <ul style="list-style-type: none"> • Continuous • Intermittent • Random 	Constant or Variable Continuous or Intermittent Ring Rotation <ul style="list-style-type: none"> • Inner ring • Outer ring 	Average Operating Operating Range Differential between rotating and non-rotating elements Ambient	Air or other gas Vacuum Moisture (humidity) Contaminants	Metallic Material <ul style="list-style-type: none"> • Ferrous • Nonferrous Non-metallic Material Stiffness Precision of Mating Parts <ul style="list-style-type: none"> • Size tolerance • Roundness • Geometry • Surface finish

Engineering

Diameter Series, Sizes, Materials

Barden bearings are categorized as miniature and instrument or spindle and turbine types. This distinction is primarily size-related, but is sometimes application-related. For example, a bearing with a one-inch O.D. is hardly miniature in size, yet it may belong in the miniature and instrument category based on its characteristics and end use. General guidelines used by Barden for classification are in Table 2.

Diameter Series

For spindle and turbine size bearings, most bore diameter sizes have a number of progressively increasing series of outside diameters, width and ball size. This allows further choice of bearing design and capacity. These series are termed Series 1900, 100, 200 and 300 and are shown in the product tables.

Sizes and Applications

Barden bearings are sized in both inch and metric dimensions. Overall, metric series bearings range from 4 to 300mm O.D.; inch series from $\frac{5}{32}$ " to $11\frac{1}{2}$ " O.D. in standard bearings.

Ball and Ring Materials

Selection of a material for bearing rings and balls is strongly influenced by availability. Standard bearing materials have been established and are the most likely to be available without delay. For special materials, availability should be determined and these additional factors considered during the selection process:

- **HARDNESS.**
- **FATIGUE RESISTANCE.**
- **DIMENSIONAL STABILITY.**
- **WEAR RESISTANCE.**
- **MATERIAL CLEANLINESS.**
- **WORKABILITY.**
- **CORROSION RESISTANCE.**
- **TEMPERATURE RESISTANCE.**

For all of its ball and ring materials, Barden has established specifications which meet or exceed industry standards. Before any material is used in Barden production, mill samples are analyzed and approved. The four predominant ring materials used by Barden are AISI 440C, SAE 52100, AISI M50 and Cronidur 30[®]. The relative characteristics of each are shown in the table 3 opposite.

AISI 440C is the standard material for instrument bearings. It is optional for spindle and turbine bearings. This is a hardenable, corrosion-resistant steel with adequate fatigue resistance, good load-carrying capacity, excellent stability and wear resistance.

SAE 52100 is the standard material for spindle and turbine bearings. It is also available in some instrument sizes, and may be preferable when fatigue life, static capacity and torque are critical. This material has excellent capacity, fatigue resistance and stability.

AISI M50 tool steel is suitable for operation up to 345°C (650°F), and consequently is widely used in high temperature aerospace accessory applications. Other non-standard tool steels such as T5 and Rex 20 are utilized for high temperature x-ray tube applications.

Cronidur 30[®] is a martensitic through-hardened high nitrogen corrosion resistant steel that can also be induction case hardened. The primary difference between AISI 440C and Cronidur 30[®], for example, is that in Cronidur 30[®] some of the carbon content has been replaced with nitrogen. This both enhances the corrosion resistance and improves the fatigue life and wear resistance.

Table 3. Properties of bearing materials.

Bearing Material	Elastic Modulus (x10 ⁶ PSI)	Density (lbs/in ³)	Poisson's Ratio	Coefficient of Expansion (µin/inch/°F)	Hardness (Rc)	Temperature Limits** (°F)
AISI 440C (M&I)	30	0.28	0.28	5.7	60-63	300
AISI 440C (S&T)	30	0.28	0.28	5.7	56-60	600
Ceramic	46	0.1156	0.26	1.7	78	2000
Cronidur 30 [®]	32	0.28	0.26	5.7	58-60	900*
AISI M50	30	0.288	0.29	6.6	61-64	650
SAE 52100 (M&I)	30	0.28	0.29	6.7	62-65	350
SAE 52100 (S&T)	30	0.28	0.29	6.7	58.5-65	390

*Secondary temper. Consult Barden's Product Engineering Department for details.

**Materials may be used at these temperatures without significant loss of hardness. Consult Barden's Product Engineering Department for details.

Fig. 1. Diameter series comparison.

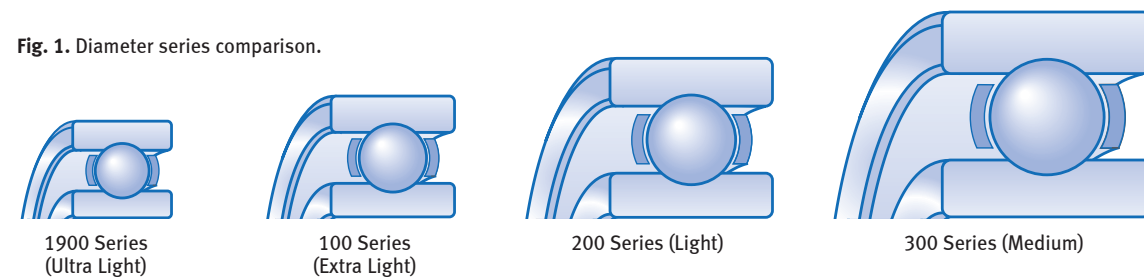

Table 2. Bearing series size ranges.

Bearing Category	Catalogue Size Range O.D.	Barden Series
Miniature & Instrument	4mm to 35mm (.1562" to 1.3750")	R, R100, M, 30
Thin Section	16mm to 200mm (.625" to 8.000")	R1000, A500, S500 ZT Series
Spindle & Turbine	22mm to 290mm (.8661" to 11.500")	1900, 100, 200, 300, 9000

Engineering

Ceramic Hybrid Bearings

Use of ceramic (silicon nitride) balls in place of steel balls can radically improve bearing performance in several ways. Because ceramic balls are 60% lighter than steel balls, and because their surface finish is almost perfectly smooth, they exhibit vibration levels two to seven times lower than conventional steel ball bearings.

Ceramic hybrid bearings also run at significantly lower operating temperatures, allowing running speeds to increase by as much as 40% to 50%. Lower operating temperatures help extend lubricant life. Bearings with ceramic balls have been proven to last up to five times longer than conventional steel ball bearings. Systems equipped with ceramic hybrids show higher rigidity and higher natural frequency making them less sensitive to vibration.

Because of the unique properties of silicon nitride, ceramic balls drastically reduce the predominant cause of surface wear in conventional bearings (metal rings/metal balls). In conventional bearings, microscopic surface asperities on balls and races will "cold weld" or stick together even under normal lubrication and load conditions. As the bearing rotates, the microscopic cold welds break, producing roughness and, eventually, worn contact surfaces. This characteristic is known as adhesive wear. Since ceramic balls will not cold weld to steel rings,

wear is dramatically reduced. Because wear particles generated by adhesive wear are not present in ceramic hybrids, lubricant life is also prolonged. The savings in reduced maintenance costs alone can be significant.

Ceramic Ball Features

60% lighter than steel balls

- CENTRIFUGAL FORCES REDUCED.
- LOWER VIBRATION LEVELS.
- LESS HEAT BUILD UP.
- REDUCED BALL SKIDDING.

50% higher modulus of elasticity

- IMPROVED BEARING RIGIDITY.
- NATURALLY FRACTURE RESISTANT.

Tribochemically inert

- LOW ADHESIVE WEAR.
- IMPROVED LUBRICANT LIFE.
- SUPERIOR CORROSION RESISTANCE.

Benefits of Ceramic Hybrid Bearings

- BEARING SERVICE LIFE IS TWO TO FIVE TIMES LONGER.
- RUNNING SPEEDS UP TO 50% HIGHER.
- OVERALL ACCURACY AND QUALITY IMPROVES.
- LOWER OPERATING COSTS.
- HIGH TEMPERATURE CAPABILITY.
- ELECTRICALLY NON-CONDUCTIVE.



Ceramic Hybrid Bearings

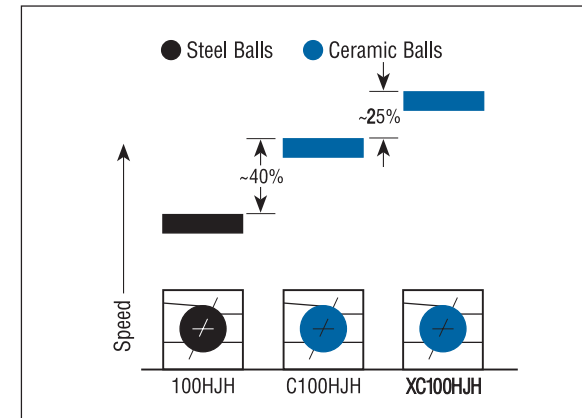

Running speed of ceramic ball exceed same-size steel ball by 40%. Converting to an X-Life Ultra Bearing with ceramic balls will boost running speeds an additional 25%.

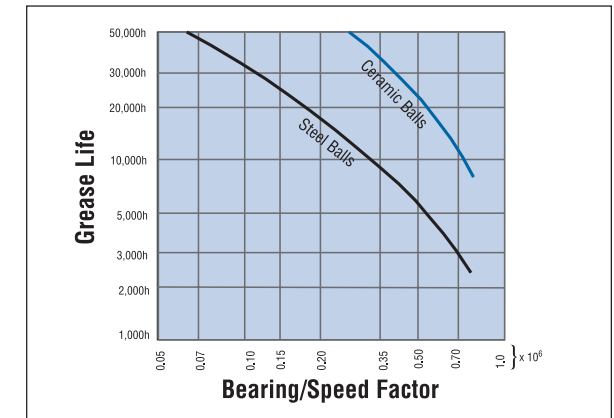

The use of ceramic balls significantly increases bearing grease life performance.

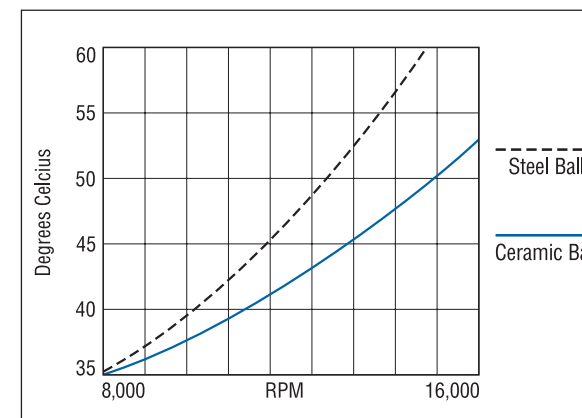

Lower operating temperature. As running speeds increase, ceramic balls always run cooler than conventional steel balls. With reduced heat build up, lubricant life is prolonged.

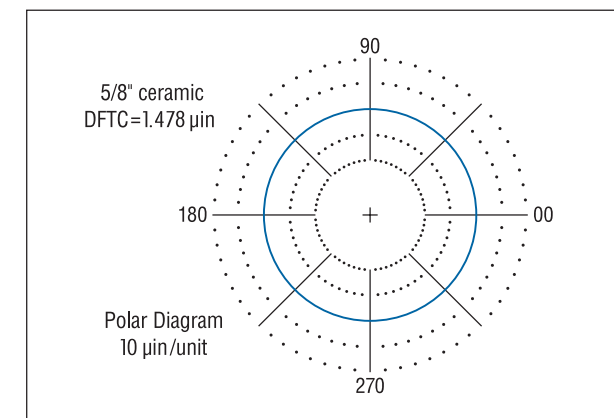

Deviation from true circularity (DFTC). Polar trace of a 5/8" silicon nitride ball indicates near perfect roundness, which results in dramatically lower vibration levels.

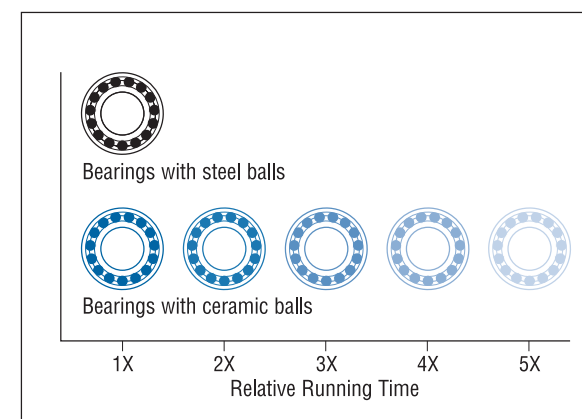

Service life of ceramic hybrid bearings is two to five times that of conventional steel ball bearings, depending upon operating conditions.

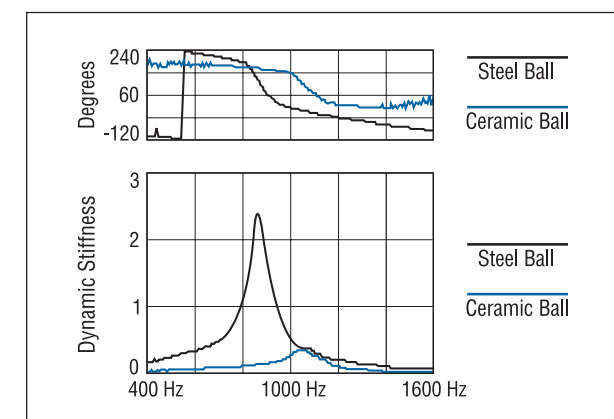

Dynamic stiffness analysis shows better rigidity and higher natural frequency for hybrid bearings.

Engineering

Ceramic Hybrid Bearings

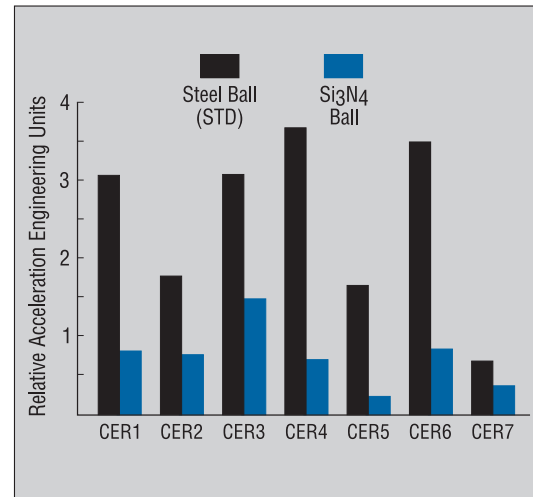

Vibration tests comparing spindles with steel ball bearings and the same spindle retrofit with ceramic hybrids. Vibration levels averaged two to seven times lower with silicon nitride balls.

Comparison of Bearing Steel and Silicon Nitride Properties		
Property	Steel	Ceramic
Density (g/cm ³)	7.8	3.2
Elastic Modulus (10 ⁶ psi)	30	45
Hardness	R.60	R.78
Coefficient of thermal expansion (X10 ⁻⁶ /°F)	6.7	1.7
Coefficient of friction	0.42 dry	0.17 dry
Poisson's ratio	0.3	0.26
Maximum use temperature (°F)	620	2000
Chemically inert	No	Yes
Electrically non-conductive	No	Yes
Non-magnetic	No	Yes

Ceramic balls are lighter and harder than steel balls, characteristics which improve overall bearing performance.



X-Life Ultra bearings offer unsurpassed toughness and corrosion resistance. They outlast conventional hybrid bearings by up to 4x or more.

X-Life Ultra Bearings

X-Life Ultra bearings were developed for the highest demands with respect to speed and loading capability. These bearings are hybrid ceramic bearings with bearing rings made from Cronidur 30[®], a high nitrogen, corrosion resistant steel. Cronidur 30[®] shows a much finer grain structure compared with the conventional bearing steel 100Cr6 (SAE 52100) resulting in cooler running and higher permissible contact stresses. Basically all bearing types are available as X-Life Ultra bearings.

The longer service life of X-Life Ultra bearings when compared to conventional bearings also contributes to an overall reduction in the total system costs. When calculating the indirect costs of frequent bearing replacement — which include not just inventory, but machine down time, lost productivity and labor — the cost savings potential of Cronidur 30[®] bearings become significant.

Surface Engineering Technology

Surface engineering is the design and modification of a surface and substrate in combination to give cost effective performance enhancement that would not otherwise be achieved. Engineering surfaces are neither flat, smooth nor clean; and when two surfaces come into contact, only a very small percentage of the apparent surface area is actually supporting the load. This can often result in high contact stresses, which lead to increased friction and wear of the component. Engineering the surface to combat friction and reduce wear is therefore highly desirable, and can offer the benefits of lower running costs and longer service intervals.

When challenged by harsh operating conditions such as marginal lubrication, aggressive media and hostile environments, surface engineering processes can provide effective protection against potential friction and wear problems. Working together with recognized leaders in advanced coatings and surface treatments, Barden can provide specialized surface engineering technology in support of the most demanding bearing applications.

Wear resistance

Wear is an inevitable, self-generating process. It is defined as “damage caused by the effects of constant use” and is perhaps the most common process that limits the effective life of engineering components.

Wear is a natural part of everyday life, and in some cases, mild wear can even be beneficial — as with the running in of mechanical equipment. However, it is the severe and sometimes unpredictable nature of wear that is of most concern to industry.

The use of surface engineering processes can effectively reduce the amount of wear on engineering components thereby extending the useful life of the product. Barden utilizes a range of hard, wear-resistant coatings and surface treatments to enhance the performance of its super precision bearing systems.



Barden employs surface engineering processes that can provide effective protection against potential friction and wear problems.

Common wear resistant treatments include:

- **HARD CHROME COATING.**
- **ELECTROLESS NICKEL PLATING.**
- **HARD ANODIZING.**
- **ARC EVAPORATED TITANIUM NITRIDE.**
- **CARBURIZING AND CARBO-NITRIDING.**
- **PLASMA NITRIDING.**

Anti-Corrosion

Corrosion can be described as the degradation of material surface through reaction with an oxidizing substance. In engineering applications, corrosion is most commonly presented as the formation of metal oxides from exposure to air and water from the environment.

Anti-corrosion processes produce a surface that is less chemically reactive than the substrate material. Examples include:

- **HARD CHROME COATING.**
- **GALVANIZED ZINC.**
- **CADMIUM PLATING (NOW BEING REPLACED BY ZINC/NICKEL).**
- **TITANIUM CARBIDE.**
- **ELECTROLESS NICKEL PLATING.**
- **TITANIUM NITRIDE.**
- **PASSIVATION TREATMENTS.**

Engineering

Surface Engineering Technology

For applications requiring good anti-corrosion performance, Barden also uses advanced material technologies, such as with the X-Life Ultra high nitrogen steel bearings. In controlled salt-spray tests, X-Life Ultra bearings have shown to give superior corrosion protection to those manufactured from industry standard steels such as AISI 440C.

Solid Lubrication

From space applications to high-tech medical instruments, solid lubricant films provide effective lubrication in the most exacting of conditions, where conventional oils and greases are rendered inadequate or inappropriate.

Solid lubricated bearings offer distinct advantages over traditional fluid-lubricated systems. Their friction is independent of temperature (from cryogenic to extreme high temperature applications), and they do not evaporate or creep in terrestrial vacuum or space environments.

Solid lubricant films can be generated in one of two basic ways, either by direct application to the surface — for example, sputter-coating of MoS₂ or by transfer from rubbing contact with a self-lubricating material — as with Barden's BarTemp® polymeric cage material.

The four basic types of solid lubricant film are:

Soft metals

- LEAD, SILVER, GOLD, INDIUM.

Lamellar solids

- MoS₂, WS₂, NbSe₂.

Polymers

- BARTEMP®, PTFE, VESPEL®, TORLON®.

Adventitious layers

- OILS AND FATS, BOUNDARY SPECIES.

Summary

A large number of coatings and surface treatments are available to combat friction, corrosion and wear, and it is often difficult for designers to select the optimum process for a particular application. There may even be a range of options available, all of which offer reasonable solutions — the choice is then one of cost and availability.

Through a network of recognized surface engineering suppliers, Barden can offer guidance on the selection of suitable treatments and processes to meet and surpass the demands of your extreme bearing applications.



Solid lubrication is intended for use in extreme conditions where greases and oils cannot be used, such as in space environments.

Bearing Cages

Proper selection of cage design and materials is essential to the successful performance of a precision ball bearing. The basic purpose of a cage is to maintain uniform ball spacing, but it can also be designed to reduce torque and minimize heat build-up.

In separable bearings, the cage is designed to retain the balls in the outer ring so the rings can be handled separately.

Cage loading is normally light, but acceleration and centrifugal forces may develop and impose cage loading. Also, it may be important for the cage to accommodate varying ball speeds that occur in certain applications.

Cages are piloted (guided) by the balls or one of the rings. Typically, low to moderate speed cages are ball-piloted. Most high-speed cages have machined surfaces and are piloted by the land of either the inner or outer ring.

Barden deep groove and angular contact bearings are available with several types of cages to suit a variety of applications. While cost may be a concern, many other factors enter into cage design and cage selection, including:

- LOW COEFFICIENT OF FRICTION WITH BALL AND RACE MATERIALS.
- COMPATIBLE EXPANSION RATE WITH BALL/RING MATERIALS.
- LOW TENDENCY TO GALL OR WEAR.
- ABILITY TO ABSORB LUBRICANT.
- DIMENSIONAL AND THERMAL STABILITY.
- SUITABLE DENSITY.
- ADEQUATE TENSILE STRENGTH.
- CREEP RESISTANCE.

This list can be expanded to match the complexity of any bearing application. As a general guide, the tables on pages 76 and 78 may be used by the designer for cage selection. Basic cage data is presented in a tabulated format for review and comparison.

When a standard cage does not meet the end use requirements, the Barden Product Engineering Department should be consulted. Barden has developed and manufactured many specialized cages for unusual applications. Some examples of conditions which merit engineering review are ultra-high-speed operation, a need for extra oil absorption, extreme environments and critical low torque situations. Materials as diverse as silver-plated steel,

bronze alloys and porous plastics have been used by Barden to create custom cages for such conditions.

Deep Groove Bearing Cages

The principal cage designs for Barden deep-groove bearings are side entrance snap-in types (Crown, TA, TAT, TMT) and symmetrical types (Ribbon, W, T). Crown and Ribbon types are used at moderate speeds and are particularly suited for bearings with grease lubrication and seals or shields. The W-type is a low-torque pressed metal cage developed by Barden, and is available in many instrument sizes. This two-piece ribbon cage is loosely clinched to prevent cage windup (a torque increasing drawback of some cage designs) in sensitive low-torque applications.

For higher speeds, Barden offers the one-piece phenolic snap-in TA-type cage in smaller bearing sizes and the two-piece riveted phenolic, aluminum-reinforced T cage for larger sizes. The aluminum reinforcement, another Barden first, provides additional strength, allowing this high-speed cage to be used in most standard width sealed or shielded bearings.

Angular Contact Bearing Cages

In Barden miniature and instrument angular contact bearings, (types B and H), machined phenolic cages with high-speed capability are standard. These cages are outer ring land guided, which allows lubricant access to the most desired point — the inner ring/ball contact area. Centrifugal force carries lubricant outward during operation to reach the other areas of need.

H-type phenolic cages are of a through-pocket halo design. The B-type cage used in separable bearings has ball pockets which hold the balls in place when the inner ring is removed.

For high-temperature applications, the larger spindle and turbine bearing cages are machined from bronze or steel (silver plated). Most of these designs are also outer ring land guided for optimum bearing lubricant access and maximum speedability.

Many non-standard cage types have been developed for specific applications. These include cages from porous materials such as sintered nylon or polyimide, which can be impregnated with oil to provide reservoirs for extended operational life.

Engineering

Deep Groove Bearing Cages

CAGES FOR DEEP GROOVE BEARINGS					Maximum Speed in dN units		Operating Temperature Range	Limitations
Type	Illustration	Use	Material	Construction	Oil Lubrication	Grease Lubrication		
Q Crown type, snap cage		General purpose	Stainless steel AISI 410	One-piece, stamped with coined ball pockets and polished surfaces	250,000	250,000	Normal up to 600°F (315°C)	Up to SR168, SR4 and S19M5
P Two-piece ribbon cage, full clinch		General purpose	Stainless steel AISI 430 AISI 305	Two piece, stamped ribbons to form spherical ball pockets, with full clinch on ears	250,000	250,000	Normal up to 900°F (482°C)	None (not used on bearings with bore smaller than 5mm)
W Two-piece ribbon cage, loosely clinched		General purpose, low torque peaking	Stainless steel AISI 430 AISI 305	Two-piece, stamped ribbons to form ball pockets, with loosely clinched ears	250,000	250,000	Normal up to 900°F (482°C)	None
TA One-piece snap cage, synthetic		High speed, general purpose	Fibre reinforced phenolic (type depends on cage size)	One-piece, machined side assembled snap-in type	600,000	600,000	Normal up to 300°F (149°C)	None
T Two-piece riveted synthetic		High speed, general purpose	Fibre reinforced phenolic/aluminum	Two-piece, machined from cylindrical segments of phenolic, armored with aluminum side plates, secured with rivets	1,200,000	850,000	Normal up to 300°F (149°C)	No contact with chlorinated solvents
ZA Tube type ball separator		Low speed, low torque, may be used without lubrication	Teflon®	Hollow cylinders of Teflon	5,000	5,000	Cryogenic to 450°F (232°C)	If used without lubricant, bearing material must be stainless steel
TB Crown type snap cage synthetic		Light load, no lube, in stainless steel bearing only, high & low temp. moderate speed	BarTemp®	One-piece, machined, side assembled, snap-in type	60,000*	-	Cryogenic to 575°F (302°C)	Use only with stainless steel, no lube. Requires shield for cage retention. Moisture sensitive. Avoid hard preload.
TQ Crown type snap cage synthetic		High speed, quiet operation	Delrin	One-piece machined, side assembled, snap-in type	600,000	600,000	Normal up to 150°F (66°C)	Low oil retention. Needs continuous or repetitive lubrication when oil is used. Unstable color.
TMT Crown type snap cage synthetic		Moderate speed, general purpose	Filled nylon 6/6	One-piece moulded, snap-in type with spherical ball pockets 100, 200 & 300 series	300,000	300,000	Normal up to 300°F (149°C)	None
TAT Crown type snap cage synthetic		Moderate to high speed, general purpose	Fibre reinforced plastic	One-piece machined snap-in type 100 and 200 series	400,000	400,000	Normal up to 300°F (149°C)	None
TGT Crown type snap cage synthetic		Moderate to high speed, general purpose	High temperature plastic	One-piece machined, snap-in type	600,000	600,000	Normal up to 397°F (203°C)	None

Maximum speed limits shown are for cage comparison purposes only. See the product section for actual bearing speedability. * Max 'dN' dry



Engineering

Angular Contact Bearing Cages

ANGULAR CONTACT CAGES FOR BEARINGS					Maximum Speed in dN units		Operating Temperature Range	Limitations
Type	Illustration	Use	Material	Construction	Oil Lubrication	Grease Lubrication		
B* One-piece, for bearings with non-separable inner rings		High speed, general purpose	Fibre reinforced phenolic	One-piece, machined from fibre-reinforced phenolic resin – conical or cylindrical stepped ball pockets to retain balls	1,200,000	1,000,000	Normal up to 300°F (149°C)	None
H** One piece, for bearings with non-separable inner rings		High speed, general purpose	Fibre reinforced phenolic	One-piece design, machined from fibre-reinforced phenolic resin – with cylindrical ball pockets	1,200,000	1,000,000	Normal up to 300°F (149°C)	None
HJB** One-piece, for bearings with non-separable inner rings		High speed, high temperature	Bronze (80-10-10)	One-piece machined cylindrical pockets	1,500,000	Not recommended	Normal up to 625°F (329°C)	Continuous or repetitive lubrication required. Stains with synthetic oil.
HJH** One-piece, for bearings with non-separable inner rings		High speed, high temperature	Bronze (80-10-10)	One-piece machined cylindrical pockets	1,500,000	Not recommended	Normal up to 625°F max (329°C)	Continuous or repetitive lubrication required. Stains with synthetic oil.
HGH** One piece, for bearings with non-separable inner rings		High speed, general purpose	High temperature plastic	One-piece machined cylindrical pockets	1,200,000	1,000,000	Normal up to 397°F (203°C)	None
JJJ One-piece, for bearings with non-separable inner rings		High speed, high temperature	Bronze (80-10-10)	One-piece machined with press formed pockets	1,500,000	Not recommended	Normal up to 625°F max (329°C)	Continuous or repetitive lubrication required. Stains with synthetic oil.
Four examples of other cage types, without designation, which would be specified under a special 'X' or 'Y' suffix.								
Toroidal separator for bearings which are non-separable		Low speed, low torque, may be used without lubrication	Teflon	Toroidal rings of Teflon encircling alternate balls	5,000	Not recommended	Cryogenic to 450°F (232°C)	If used without lubricant, bearing material must be stainless steel
One-piece for bearings which are non-separable		High speed, high temperature	Silver plated steel	One-piece machined cylindrical pockets silver plated	1,500,000	Not recommended	Normal up to 650°F (345°C)	Continuous or repetitive lubrication required. Stains with synthetic oil.
One-piece, for bearings which are both separable and non-separable		Moderate speed	Porous nylon	One-piece machined from sintered nylon cylindrical stepped pockets	150,000	Not recommended	Normal up to 203°F (95°C)	Not suitable for very wide temperature ranges due to high thermal expansion characteristic.
One-piece, for bearings which are both separable and non-separable		Moderate speed	Porous polyimide	One-piece machined from sintered polyimide cylindrical pockets or cylindrical stepped pockets	150,000	Not recommended	Normal up to 600°F (315°C)	None

Maximum speed limits shown are for cage comparison purposes only. See the product section for actual bearing speedability.

*Bearing type designation with standard cage: do not repeat in bearing number.

**Letter 'H' denotes bearing type – do not repeat 'H' in bearing number.



Type B



Type H

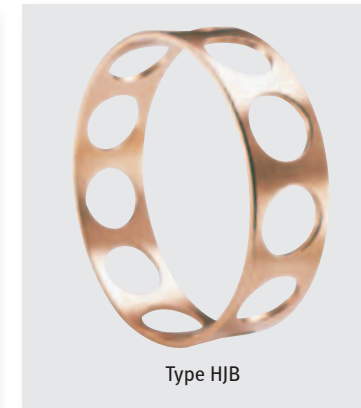

Type HJB

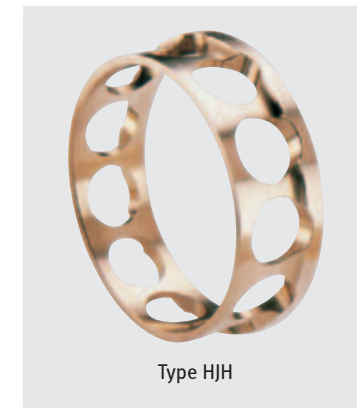

Type HJH



Type HGH



Type JJJ



Teflon toroids



Silver Plated Steel



Porous Nylon



Porous Polyimide

Engineering

Bearing Closures

The two basic types of bearing closures are shields and seals, both of which may be ordered as integral components of deep groove bearings.

Closures for angular contact bearings can also be supplied. Barden's Product Engineering Department can provide more information if required.

All closures serve the same purposes with varying effectiveness. They exclude contamination, contain lubricants and protect the bearing from internal damage during handling.

Closures are attached to the outer ring. If they contact the inner ring, they are seals. If they clear the inner ring, they are shields. Seals and shields in Barden bearings are designed so that the stringent precision tolerances are not affected by the closures. They are available in large precision spindle and turbine bearings as well as in Barden instrument bearings.

Closures Nomenclature

In the Barden nomenclature, closures are designated by suffix letters:

- **S – (SHIELD).**
- **A – (BARSHIELD™).**
- **F – (FLEXEAL™).**
- **U – (SYNCHROSEAL™).**
- **Y, P, V – (BARSEAL™).**

Usually two closures are used in a bearing, so the callout is a double letter e.g. "FP", "SS" etc. The closure callout follows the series-size and bearing type.

Example:

200 Series — **206** — **SS** — **T5**
 Bore 06 (30mm) — Two Shields — "T" Cage and Code 5 Radial Play

Selection of Closures

Determining the proper closure for an application involves a trade-off, usually balancing sealing efficiency against speed capability and bearing torque.

Shields do not raise bearing torque or limit speeds, but they have low sealing efficiency. Seals are more efficient, but they may restrict operating speed and increase torque and temperature.

Another consideration in closure selection is air flow through the bearing which is detrimental because it carries contamination into the bearing and dries out the lubricant. Seals should be used if air flow is present.



Shield (SS)



Barshield (AA), Buna-N Barseal (YY)



Flexeal (FF)



Synchro Seal (UU)



Polyacrylic Barseal (PP)



Viton® Barseal (VV)

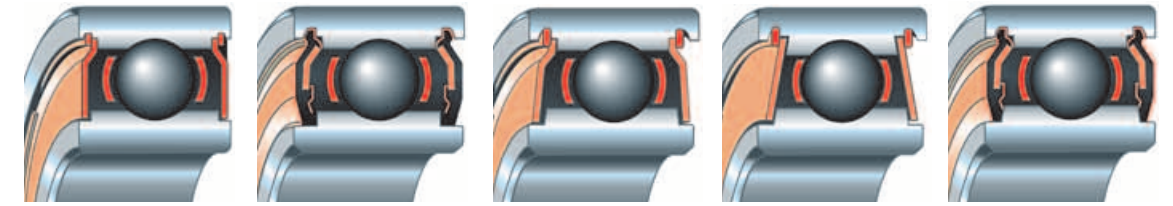

Shield

Barshield™

Flexeal™

Synchro Seal™

Barseal™

CAGES FOR DEEP GROOVE BEARINGS					Maximum Speed	Operating Temperature Range	Limitations
Type	Use	Material	Construction	Benefits	(dN units)		
SS Shields	Low torque, high speed closure that can provide lubricant retention and limited contamination protection	302 Stainless steel	Precision stamping	Maximum lubricant space, resistance to vibration	Not limited by shield design	315°C 600°F	Limited contamination protection
AA Barshield	High speed rubber shield that provides improved protection from contamination without reducing allowable operating speeds	Rubber, metal insert	Rubber material bonded to metal stiffener	Good exclusion of contamination without a reduction in operating speed	Not limited by shield design	-38°C to 107°C -30°F to 225°F	May not prevent entrance of gases or fluids
FF Flexeals	Minimum torque, low friction seal that provides lubricant retention and contamination protection	Aluminum/fiber laminate	Precision stamping & bonding	Excellent exclusion of contamination, resistance to aircraft hydraulic fluids	650,000	150°C/300°F continuous 176°C/350°F intermittent	May not prevent entrance of gases or fluids
UU Synchro Seal	Specialized seal suitable for low torque applications	Teflon filled fiber glass	Thin ring, piloted in a specially designed inner ring notch	Low torque, positive seal that can prevent the entrance of solid, gaseous or liquid contamination	100,000	315°C 600°F	Limited to low speed operation
YY Buna-N-Barseal	YY closures provide improved sealing performance compared to Flexeals	Buna-N rubber, metal insert	Rubber material bonded to metal stiffener	Excellent positive sealing to prevent the entrance of foreign contaminants	180,000	-54°C to 107°C -65°F to 225°F	Limited to relatively low speed and temperature operation
PP Polyacrylic Barseal	Polyacrylic Barseals provide a positive seal and allow for higher temperature operation than YY seals	Polyacrylic rubber, metal insert	Rubber material bonded to metal stiffener	Excellent positive sealing to prevent the entrance of foreign contaminants	180,000	-21°C to 130°C -5°F to 265°F	Requires relatively low speed operation
VV Viton Barseal	While similar in design to YY and PP seals, VV seals provide for high temperature operation	Viton rubber, metal insert	Rubber material bonded to metal stiffener	Excellent positive sealing to prevent the entrance of foreign contaminants	180,000	-40°C to 288°C -40°F to 550°F	Viton material provides excellent thermal and chemical properties and is the material of choice for aerospace bearings

Maximum speed limits shown are for seal comparison purposes only. See the product section for actual bearing speedability.

Engineering

Attainable Speeds and Limiting Speed Factors

Attainable Speeds

Attainable speed is defined as the speed at which the internally generated temperature in a mounted bearing reaches the lowest of the maximum temperatures permissible for any one of its components, including the lubricant.

Attainable speeds shown in the product tables are values influenced by bearing design and size; cage design and material; lubricant type, quantity and characteristics; type of lubrication system; load; alignment and mounting. With so many interactive factors, it is difficult to establish a definitive speed limit. The listed values in this catalogue represent informed judgments based on Barden experience.

Each listed attainable speed limit assumes the existence of proper mounting, preloading and lubrication. For an oil-lubricated bearing, an adequate oil jet or air/oil mist lubrication system should be used. For a grease-lubricated bearing, the proper type and quantity of grease should be used (see pages 98–105). When the actual operating speed approaches the calculated limiting speed, Barden Product Engineering should be contacted for a thorough application review.

Mounting and operating conditions which are less than ideal will reduce the published speed limits. Limiting speed factors for preloaded bearings with high speed cages are shown in Table 4. They may be used to modify listed values to reflect various application conditions. Increasing stiffness by replacing a spring preload with a rigid (or solid) preload by means of axial adjustment also reduces the speed potential.

Table 4. Speed factors applicable to all series with high speed retainers — B, T, H, HJB, HJH, and JJJ.

Type of Preload	Speed Factors		
	L (Light)	M (Medium)	H (Heavy)
Spring Load or Preload			
Single Bearings (Spring Loaded)	*	1.0	-
Duplex Pairs			
DB	0.75	0.66	0.35
DF	0.65	0.50	0.30
Tandem Pairs (Spring Loaded)	*	0.90	-

*Spring-preloaded bearings require preloads heavier than L at limiting speeds.

Limiting Speed Factors

Table 4 applies to both deep groove and angular contact bearings. Applicable to all series of deep groove and angular contact bearings with ultra high speed cages, B, H, HJB, HJH, JJJ and T. These factors are applied to limiting speeds shown in the Product Section.

Example: An existing application has a turbine running at 16,000 rpm using 211HJH tandem pairs with oil lubrication. Can speed be increased? And if so, to what value?

Step 1:..... Obtain oil lubricated base attainable speed from product table, page 41. 27,200 rpm

Step 2: Multiply by factor for medium DT preload from Table 40.9

Answer: Modified speed..... 24,480 rpm
Therefore spindle speed can be increased to approximately 24,480 rpm.

Example: Find limiting speed for a duplex pair of 206 deep groove bearings with Flexeals, grease lubrication and medium DB preload (Bearing Set #206FT5DBM G-42).

Step 1: Obtain grease lubricated base limiting speed from product table, page 31. 28,333 rpm

Step 2: Multiply by factor for medium DB preload from Table 4:0.66

Answer: Modified limiting speed 18,699 rpm

Speedability Factor dN

In addition to rpm ratings, ball bearings may also have their speed limitations or capabilities expressed in dN values, with dN being:

dN = bearing bore in mm multiplied by speed in rpm.

This term is a simple means of indicating the speed limit for a bearing equipped with a particular cage and lubricant. For instance, angular contact bearings which are grease-lubricated and spring-preloaded should be limited to approximately 1,000,000 dN. Deep groove bearings with metal cages should not exceed approximately 250,000 dN, regardless of lubricant.

Internal Design Parameters and Radial Internal Clearance

Internal Design Parameters

The principal internal design parameters for a ball bearing are the ball complement (number and size of balls), internal clearances (radial play, axial play and contact angle), and raceway curvature.

Ball Complement

The number and size of balls are generally selected to give maximum capacity in the available space. In some specialized cases, the ball complement may be chosen on a basis of minimum torque, speed considerations or rigidity.

Raceway Curvature

The raceway groove in the inner and outer rings has a cross race radius which is slightly greater than the ball radius (see Fig. 2). This is a deliberate design feature which provides optimum contact area between balls and raceway, to achieve the desired combination of high load capacity and low torque.

Radial Internal Clearance

Commonly referred to as radial play, this is a measure of the movement of the inner ring relative to the outer ring, perpendicular to the bearing axis (Fig. 3). Radial play is measured under a light reversing radial load then corrected to zero load. Although often overlooked by designers, radial play is one of the most important basic bearing specifications. The presence and magnitude of radial play are vital factors in bearing performance. Without sufficient radial play, interference fits (press fits) and normal expansion of components due to temperature changes and centrifugal force cannot be accommodated, causing binding and premature failure.

The radial internal clearance of a mounted bearing has a profound effect on the contact angle, which in turn influences bearing capacity, life and other performance characteristics. Proper internal clearance will provide a suitable contact angle

to support thrust loads or to meet exacting requirements of elastic yield.

High operating speeds create heat through friction and require greater than usual radial play. Higher values of radial play are also beneficial where thrust loads predominate, to increase load capacity, life and axial rigidity. Low values of radial play are better suited for predominately radial support.

Deep groove bearings are available from Barden in a number of radial play codes, each code representing a different range of internal radial clearance, (see tables on pages 84 and 85). The code number is used in bearing identification, as shown in the Nomenclature section.

The available radial play codes are listed in the tables that follow. These radial play codes give the designer wide latitude in the selection of proper radial internal clearance. It should be noted here that different radial play codes have nothing to do with ABEC tolerances or precision classes, since all

Fig. 2. Raceway curvature.

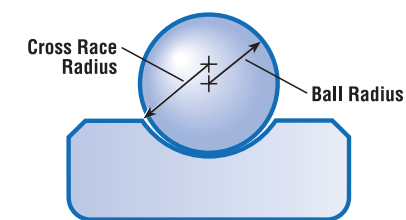

Barden bearings are made to ABEC 7 or higher standards, and the radial play code is simply a measure of internal clearance. Specifying a radial code must take into account the installation practice. If a bearing is press fitted onto a shaft or into a housing, its

internal clearance is reduced by up to 80% of the interference fit. Thus, an interference fit of .006mm could cause a .005mm decrease in internal clearance.

Deep groove bearings with Code 3 and Code 5 radial play are more readily available than those with other codes. When performance requirements exceed the standard radial play codes, consult the Barden Product Engineering Department. Special ranges of internal clearance can be supplied, but should be avoided unless there is a technical justification.

Angular contact bearings make use of radial play, combined with thrust loading, to develop their primary characteristic, an angular line of contact between the balls and both races.

Engineering

Radial Internal Clearance

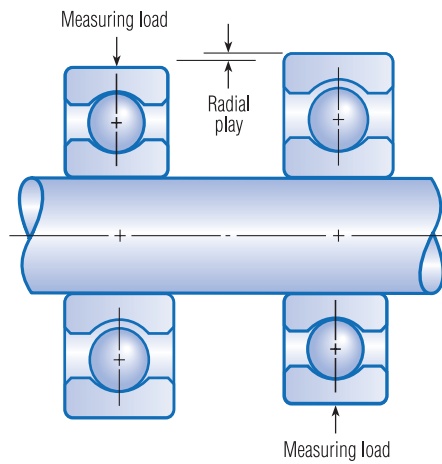

Fig. 3. Radial play is a measure of internal clearance and is influenced by measuring load and installation practices. A high radial play value is not an indication of lower quality or less precision.

Table 5A. Radial play range of deep groove instrument bearings for various radial play codes.

Basic Bearing Type	Radial Play Codes				
	2	3	4	5	6
Deep Groove Instrument (Inch)	.0001	.0002	.0003	.0005	.0008
Deep Groove Instrument (Metric)	to	to	to	to	to
Deep Groove Flange (Inch)	.0003	.0004	.0005	.0008	.0010
Deep Groove Thin Section (Inch) SR1000 Series	-	-	-	.0003 to .0008	.0005 to .0010
Deep Groove Thin Section (Inch) 500 Series	-	-	-	.0005 to .0010	.0008 to .0014

All dimensions in inches.

Table 5B. Radial play code selection guide for deep groove instrument bearings.

Performance Requirements	Loads and Speeds	Recommended Radial Play Code	Limitations
Minimum radial clearance without axial adjustment.	Light loads, low speeds.	3	Lowest axial load capacity. Highest torque under thrust. Not suitable for hot or cold running applications. Must not be interference fitted to either shaft or housing.
Internal clearance not critical; moderate torque under thrust loading.	Moderate loads and speeds.	3	Axial adjustment for very low speed or axial spring loading for moderate speed may be necessary.
Minimum torque under thrust loading; endurance life under wide temperature range.	Moderate to heavy loads, very low to high speeds.	5	Axial adjustment, spring preloading or fixed preloads usually required; light interference fits permissible in some cases.
Specific requirements for axial and radial rigidity; high thrust capacity at extreme speeds and temperatures.	Moderate to heavy loads at high speeds.	Consult Barden.	Complete analysis of all performance and design factors is essential before radial play specification.

Table 6. Available radial play ranges for angular contact instrument bearings.

Basic Bearing Number	Radial Play Codes			
	Standard (No Code)	4	5	6
SR2B	.0003 - .0011	-	-	-
SR2H	.0003 - .0005	-	-	-
SR3B, SR4B	.0005 - .0014	-	-	-
SR3H, SR4H, SR4HX8	.0003 - .0006	-	.0005 - .0008	-
34BX4, 34-5B, 36BX1	.0006 - .0016	-	-	-
34-5H	.0005 - .0008	.0003 - .0005	.0005 - .0008	.0008 - .0011
36H, 38H, 39H	.0005 - .0008	-	.0005 - .0008	.0008 - .0011
38BX2	.0007 - .0017	-	-	-

All dimensions in inches.

Table 7. Radial play code selection guide for deep groove spindle and turbine bearings.

Performance Requirements	Loads and Speeds	Recommended Radial Play Code	Limitations
Axial and radial rigidity, minimum runout.	Light loads, high speeds.	Consult Barden.	Complete analysis of all performance and design factors is essential before radial play specification.
Axial and radial rigidity, low runout.	Heavy loads, low to moderate speeds.	5	Axial adjustment, spring preloading or fixed preloading is usually required; interference fits required on rotating rings.
Minimum torque, maximum life under wide temperature range.	Moderate.	5 or 6	May require spring preloading; usually interference fitted on rotating ring.

Table 8. Radial play ranges of Barden deep groove spindle and turbine bearings for various radial play codes.

Basic Bearing Number	Radial Play Codes		
	3	5	6
100 - 103	.0002 - .0004	.0005 - .0008	.0008 - .0011
104 - 107	.0002 - .0005	.0005 - .0009	.0009 - .0014
108	.0002 - .0005	.0007 - .0012	.0012 - .0017
109 - 110	.0004 - .0008	.0008 - .0013	.0013 - .0019
111	.0005 - .0010	.0010 - .0016	.0016 - .0023
200 - 205	.0002 - .0005	.0005 - .0009	.0009 - .0014
206 - 209	.0002 - .0005	.0007 - .0012	.0012 - .0017
210	.0004 - .0008	.0008 - .0013	.0013 - .0019
211 - 213	.0005 - .0010	.0010 - .0016	.0016 - .0023
214 - 216	.0005 - .0011	.0011 - .0019	.0019 - .0027
217 - 220	.0006 - .0013	.0013 - .0022	.0022 - .0032
221 - 224	.0007 - .0015	.0015 - .0025	.0025 - .0037
226 - 228	.0008 - .0018	.0018 - .0030	.0030 - .0043
230 - 232	.0008 - .0020	.0020 - .0034	.0034 - .0049
300 - 303	.0002 - .0004	.0005 - .0008	.0008 - .0011
304	.0003 - .0007	.0006 - .0010	.0009 - .0014
305 - 306	.0003 - .0007	.0006 - .0010	.0010 - .0015
307 - 308	.0003 - .0007	.0007 - .0012	.0012 - .0017
309 - 310	.0004 - .0008	.0008 - .0013	.0013 - .0019
311 - 313	.0005 - .0010	.0010 - .0016	.0016 - .0023
314 - 316	.0005 - .0011	.0011 - .0019	.0019 - .0027
317 - 320	.0006 - .0013	.0013 - .0022	.0022 - .0032
322 - 324	.0007 - .0015	.0015 - .0025	.0025 - .0037

All dimensions in inches.

Table 9. Radial play ranges of Barden 100 B-Type separable 15° angular contact bearings.

Basic Bearing Number	Radial Play Range	Basic Bearing Nomenclature	Radial Play Range
101B, 102B, 103B	.0008 - .0012	108B	.0017 - .0021
104B, 105B	.0012 - .0016	110B	.0018 - .0023
106B	.0013 - .0017	113B	.0021 - .0027
107B	.0015 - .0019	117B	.0027 - .0035

All dimensions in inches.

Table 10. Radial play ranges of Barden 1900H, 100H, 200H, 300H series 15° angular contact bearings.

Basic Bearing Number	Radial Play Range
1900H, 1901H, 1902H, 1903H	.0004 - .0008
1904H, 1905H, 1906H, 102H, 105H	.0006 - .0010
1907H, 100H, 101H, 103H, 106H, 200H	.0007 - .0011
107H, 201H, 202H, 203H	.0008 - .0012
108H, 301H	.0008 - .0013
302H, 303H	.0009 - .0014
104H	.0010 - .0014
109H, 110H	.0010 - .0015
204H, 205H	.0011 - .0015
206H, 304H	.0011 - .0017
111H, 112H, 113H	.0012 - .0018
207H, 208H, 209H, 305H	.0012 - .0017
114H, 115H, 210H	.0014 - .0020
306H	.0014 - .0022
116H, 117H, 211H, 307H	.0015 - .0023
118H, 119H, 120H, 212H, 308H	.0017 - .0025
213H, 214H, 215H, 309H	.0020 - .0028
310H	.0021 - .0031
216H	.0022 - .0030
217H	.0023 - .0033
218H	.0026 - .0036
219H, 220H	.0030 - .0040

All dimensions in inches.

Engineering

Contact Angle

Contact angle is the nominal angle between the ball-to-race contact line and a plane through the ball centers, perpendicular to the bearing axis (see Fig. 4). It may be expressed in terms of zero load or applied thrust load.

The unloaded contact angle is established after axial takeup of the bearing but before imposition of the working thrust load. The loaded contact angle is greater, reflecting the influence of the applied thrust load.

Each radial play code for Barden deep groove bearings has a calculable corresponding contact angle value.

Angular contact bearings, on the other hand, are assembled to a constant contact angle by varying the radial clearance. Spindle size Barden angular contact bearings have nominal contact angles of 15°.

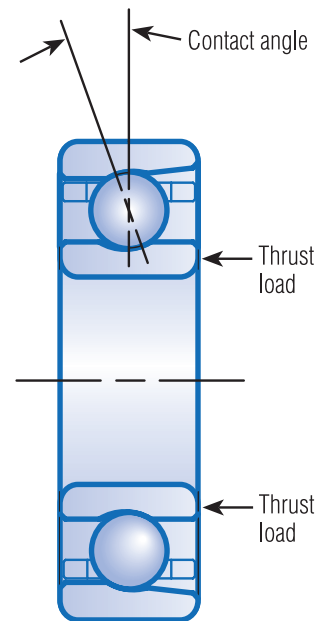

Fig. 4. Contact angle refers to the nominal angle between the ball-to-race contact line and a plane through the ball centers, perpendicular to the bearing axis.

Table 11. Initial contact angles for deep groove miniature and instrument and thin section bearings.

Basic Bearing Number	Radial Play Codes				
	2	3	4	5	6
	Initial Contact Angle, Degrees				
SR0, SR133	12.3	15.1	17.3	22.2	26.9
SR1, SR1-4, SR143, SR144, SR144X3, SR154X1, SR155, SR156, SR156X1, SR164, SR164X3, SR168, SR174X2, SR174X5, SR184X2, SR2X52	10.9	13.4	15.5	19.8	24.0
SR1-5, SR2, SR2A, SR2-5, SR2-6, SR2-5, SR2-6, SR2-5X2, SR166, SR186X2, SR186X3, SR188, SR1204X1, SR1810	8.7	10.7	12.2	15.7	19.0
SR3, SR3X8, SR3X23, SR4, SR4X35	7.1	8.7	10.0	12.8	15.5
SR4A	5.8	7.1	8.1	10.4	12.6
SR6	5.5	6.7	7.7	9.9	12.0
SR8	11.3	13.7	15.8	20.2	24.2
SR10	11.0	13.3	15.3	19.6	23.5
S18M1-5, S19M1-5, S19M2-5	12.3	15.1	17.3	22.2	26.9
S19M2, S38M2-5	10.9	13.4	15.5	19.8	24.0
S38M3	10.2	12.4	14.3	18.3	22.0
S2M3, S18M4, S38M4	8.7	10.7	12.2	15.7	19.0
S2M4	7.1	8.7	10.0	12.8	15.5
34, 34-5	6.2	7.5	8.7	11.1	13.3
35, 36	5.8	7.1	8.1	10.4	12.6
S18M7Y2	7.8	9.4	10.9	13.9	16.8
37, 38	5.5	6.7	7.7	9.9	12.0
37X2, 38X2, 38X6	11.3	13.9	16.0	20.5	24.8
39	10.9	13.2	15.2	19.4	23.6
A538 to A543	-	-	-	22.2	26.9
S538 to S543	-	-	-	17.4	20.4
SR1012, SR1216, SR1624	-	-	-	15.7	19.0

Table 12. Initial contact angles for deep groove spindle and turbine bearings.

Basic Bearing Number	Radial Play Codes		
	3	5	6
	Initial Contact Angle, Degrees		
100	13.3	19.6	23.7
100X1	8.7	12.8	15.5
101	10.8	16	19.3
101X1	13.3	19.6	23.7
102	11.5	16.9	20.5
103	13.3	19.6	23.7
104	9.2	13	16.8
105	10.7	15.2	19.5
106	8.6	12.2	15.7
107	7.8	11.1	14.2
108	9.6	15.9	19.6
109, 110	11.5	15.2	18.8
111	11.9	15.7	19.2
200	11.5	16.3	20.9
201, 201X1	11.1	15.7	20.2
202, 202X1	10.7	15.2	19.5
203	10.4	14.8	18.9
204, 9204, 205, 9205	9.6	13.6	17.5
206, 9206	8.8	14.5	17.9
207, 9207	8.1	13.4	16.6
208, 9208, 209, 9209	7.8	12.9	16
210	9.9	13.2	16.3
211	10.4	13.7	16.9
213	9.9	13.1	16.1
222	9.0	12.1	15.1
232	8.5	12.7	15.9
303	7.6	11.0	13.5
305	9.7	12.3	15.4
306	9.3	11.8	14.8
307	8.5	11.7	14.5
308	8.1	11.2	13.8
309	8.5	11.2	13.9
310	8.1	10.7	13.3
311	8.7	11.5	14.1
312	8.4	11.1	13.6
313	8.1	10.7	13.1
316	7.9	10.8	13.4
317	8.3	11.3	14.1
318	8.1	11.0	13.7
322	7.8	10.5	13.1

Engineering

Axial Play

Axial play, also called end play, is the maximum possible movement, parallel to the bearing axis, of the inner ring in relation to the outer ring. It is measured under a light reversing axial load.

End play is a function of radial internal clearance, thus the nominal end play values given in Table 13 and Table 14 are expressed for various radial play codes of deep groove instrument and spindle turbine bearings.

End play will increase when a thrust load is imposed, due to axial yield. If this is objectionable, the end play can be reduced by axial shimming or axial preloading.

End play is not a design specification. The Barden Product Engineering Department should be consulted if end play modifications are desired.

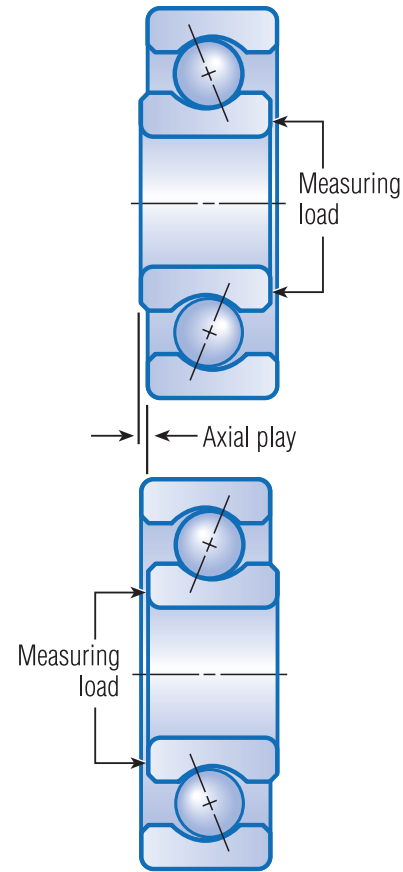

Fig. 5. Axial play, or end play, is defined as the maximum possible movement, parallel to the axis of the bearing, of the inner ring relative to the outer ring.

Table 13. Nominal axial play values of deep groove miniature and instrument and thin section bearings.

Basic Bearing Number	Radial Play Codes				
	2	3	4	5	6
SR0, SR133	.0019	.0023	.0026	.0033	.0040
SR1, SR1-4, SR143, SR144, SR144X3, SR154X1, SR155, SR156, SR156X1, SR164, SR164X3, SR168, SR174X2, SR174X5, SR184X2, SR2X52	.0021	.0026	.0029	.0037	.0045
SR1-5, SR2, SR2A, SR2-5, SR2-6, SR2-5X2, SR166, SR186X2, SR186X3, SR188, SR1204X1, SR1810	.0026	.0032	.0037	.0047	.0057
SR3, SR3X8, SR3X23, SR4, SR4X35	.0033	.0040	.0046	.0058	.0070
SR4A	.0038	.0048	.0053	.0072	.0085
SR6	.0042	.0051	.0059	.0075	.0090
SR8	.0021	.0025	.0029	.0037	.0044
SR10	.0021	.0026	.0030	.0038	.0053
S18M1-5, S19M1-5, S19M2-5	.0019	.0023	.0026	.0033	.0040
S19M2, S38M2-5	.0021	.0026	.0029	.0037	.0045
S38M3	.0023	.0028	.0032	.0041	.0049
S2M3, S18M4, S38M4	.0026	.0032	.0037	.0047	.0057
S2M4	.0033	.0040	.0046	.0058	.0070
34, 34-5	.0037	.0046	.0053	.0067	.0081
35, 36	.0040	.0049	.0056	.0071	.0086
S18M7Y2	.0030	.0036	.0042	.0054	.0064
37, 38	.0042	.0051	.0059	.0075	.0091
37X2, 38X2, 38X6	.0020	.0024	.0028	.0035	.0042
39	.0021	.0026	.0030	.0038	.0045
A538 to A543	-	-	-	.0033	.0040
S538 to S543	-	-	-	.0052	.0061
SR1012, SR1216, SR1624	-	-	-	.0044	.0051

All dimensions in inches.

Table 14. Nominal axial play values of deep groove spindle and turbine bearings.

Basic Bearing Number	Radial Play Codes		
	3	5	6
100	.0026	.0038	.0045
100X1	.0040	.0058	.0070
101, 101X1	.0032	.0046	.0056
102	.0030	.0044	.0053
103	.0026	.0038	.0045
104	.0044	.0062	.0079
105	.0037	.0052	.0067
106	.0046	.0065	.0084
107	.0051	.0072	.0092
108	.0042	.0068	.0084
109, 110	.0060	.0079	.0097
111	.0072	.0095	.0115
200	.0035	.0049	.0062
201, 201X1, 9201	.0036	.0051	.0065
1902X1	.0039	.0057	.0068
202, 202X1	.0037	.0052	.0067
203, 9203	.0038	.0054	.0069
204, 9204, 205, 9205	.0042	.0059	.0075
206, 9206	.0046	.0075	.0092
207, 9207	.0049	.0081	.0100
208, 9208, 209, 9209	.0051	.0084	.0103
210	.0069	.0091	.0112
211	.0082	.0107	.0131
213	.0091	.0119	.0145
222	.0140	.0189	.0234
232	.0175	.0242	.0299
9302X1	.0029	.0043	.0052
303	.0041	.0059	.0072
305, 9305	.0059	.0074	.0093
306	.0061	.0077	.0096
307, 9307	.0071	.0097	.0120
308, 9308	.0071	.0097	.0120
309, 9309	.0081	.0107	.0132
310, 9310	.0085	.0112	.0138
311	.0099	.0129	.0158
312, 9312	.0102	.0134	.0164
313, 9313	.0106	.0139	.0170
314, 9314	.0113	.0154	.0180
316	.0116	.0159	.0196
317	.0130	.0177	.0219
318	.0134	.0182	.0225
320	.0211	.0286	.0355
322	.0152	.0204	.0253

All dimensions in inches.

Engineering

Ball Complement

Table 15. Deep groove instrument (inch) bearings.

Basic Bearing Number	Ball Complement	
	Number	Diameter
SR0	6	1/32"
SR133	7	1/32"
SR1	6	1mm
SR1-4, SR143, SR144, SR144X3, SR154X1	8	1mm
SR164X3, SR174X5, SR184X2, SR133W	8	1mm
SR155, SR156	9	1mm
SR2X52, SR174X2, SR156X1, SR168	11	1mm
SR1-5, SR2-5, SR2-5X2	6	1/16"
SR2-6, SR2, SR2A	7	1/16"
SR1204X1, SR166, SR186X2, SR186X3	8	1/16"
SR188, SR1810	11	1/16"
SR3, SR3X8, SR3X23	7	3/32"
SR4, SR4X35	8	3/32"
SR4A	6	9/64"
SR6	7	5/32"
SR8	10	5/32"
SR10	10	3/16"

Table 16. Deep groove flanged (inch) bearings.

Basic Bearing Number	Ball Complement	
	Number	Diameter
SFR0	6	1/32"
SFR133	7	1/32"
SFR1	6	1mm
SFR1-4, SFR144	8	1mm
SFR155, SFR156	9	1mm
SFR168	11	1mm
SFR1-5, SFR2-5	6	1mm
SFR2-6, SFR2	7	1/16"
SFR166	8	1/16"
SFR188, SFR1810	11	1/16"
SFR3, SFR3X3	7	3/32"
SFR4	8	3/32"
SFR6	7	5/32"

Table 17. Deep groove instrument (metric) bearings.

Basic Bearing Number	Ball Complement	
	Number	Diameter
S18M1-5	6	1/32"
S19M2	7	1mm
S19M1-5	7	1mm
S18M2-5, S38M2-5, S19M2-5	8	1mm
S38M3	7	3/64"
S2M3, S18M4, S38M4	7	1/16"
S19M5	11	1/16"
S18M7Y2	9	2mm
S2M4	7	3/32"
34, 34-5	6	1/8"
35, 36	6	9/64"
37, 37X2, 38, 38X2, 38X6	7	5/32"
39	7	3/16"

Table 18. Deep groove thin section (inch) bearings.

Basic Bearing Number	Ball Complement	
	Number	Diameter
SR1012ZA, SWR1012ZA	12	1/16"
SR1012TA, SWR1012TA	14	1/16"
SR1216ZA	15	1/16"
SR1216TA	17	1/16"
SR1420ZA	18	1/16"
SR1420TA	20	1/16"
SR1624ZA	21	1/16"
SR1624TA	23	1/16"
SN538ZA, A538ZA	9	1/8"
SN539ZA, A539ZA	11	1/8"
SN538TA, A538TA, A539T	12	1/8"
SN540ZA, A540ZA	13	1/8"
SN539TA, A540T	14	1/8"
SN541ZA, A541ZA	15	1/8"
SN540TA, A541ZA	14	1/8"
SN541TA, A542T	18	1/8"
SN542ZA, A542ZA	19	1/8"
SN542TA	20	1/8"
SN543ZA, SN543TA, A543TA, A543T	22	1/8"

Table 19. Deep groove Spindle and Turbine (metric) bearings.

Basic Bearing Number	Ball Complement	
	Number	Diameter
1902X1	11	9/64"
100, 100X1	7	3/16"
101, 101X1(T), 101X1(TMT)	8	3/16"
102	9	3/16"
103	10	3/16"
200	7	7/32"
201, 201X1, 9201	7	15/64"
202(T), 202(TMT), 202X1	7	1/4"
104	9	1/4"
105	10	1/4"
203(T), 203(TMT), 9203	8	17/64"
106	11	9/32"
9302X1	7	5/16"
204(T), 204(TMT), 9204(TMT), 205(T), 205(TMT), 9205(T), 9205(TMT)	8	5/16"
107	11	5/16"
108	12	5/16"
206(T), 206(TMT), 9206(T), 9206(TMT)	9	3/8"
110	13	3/8"
109	16	3/8"
9305	7	7/16"
207(T), 207(TMT), 9207(T), 9207(TMT)	9	7/16"
111	12	7/16"
208(T), 208(TMT), 9208(T), 9208(TMT)	9	15/32"
305, 209(T), 209(TMT), 9209(T), 9209(TMT)	10	15/32"
210	10	1/2"
9307(T), 9307(TMT)	7	9/16"
307(T), 307(TMT)	7	9/16"
211	14	9/16"
308, 9308	8	5/8"
9309	8	11/16"
309	11	5/8"
9310	8	3/4"
310	11	3/4"
311	8	13/16"
312, 9312	8	7/8"
313(T), 9313(T), 9313(TMT)	8	15/16"
314	8	1"
9314	8	1"
315, 316	8	1 1/16"
317	8	1 1/8"
222	10	1 1/8"
318	8	1 3/16"
320	8	1 3/8"
232	11	1 3/8"
322	8	1 1/2"

Table 20. Angular contact (inch) bearings.

Basic Bearing Number	Ball Complement	
	Number	Diameter
R144H	8	1mm
R1-5B	6	1/16"
R1-5H, R2-5B, R2B, R2-6H	7	1/16"
R2H, R2-5H	8	1/16"
R3B	7	3/32"
R3H, R4B	8	3/32"
R4H	9	3/32"
R4HX8	8	9/64"
R8H	12	5/32"

Ball Complement

Table 21. Angular Contact (metric) bearings.

Basic Bearing Number	Ball Complement	
	Number	Diameter
2M3BY3	7	1/16"
19M5BY1	11	1/16"
34BX4, 34-5B	6	1/8"
34H, 34-5H	8	1/8"
36BX1	6	9/64"
36H	8	9/64"
38BX2	7	5/32"
37H, 38H	9	5/32"
1901H	11	5/32"
1902H	14	5/32"
39H, 100H	9	3/16"
101H, 101BX48, 102BJX6	10	3/16"
102H, 102BX48	11	3/16"
103H, 103BX48	13	3/16"
200H	9	7/32"
1905	16	7/32"
201H	9	15/64"
202H	10	1/4"
104H, 104BX48	11	1/4"
105H, 105BX48	13	1/4"
1907H	19	1/4"
301H	9	17/64"
203H	10	17/64"
106H, 106BX48	14	9/32"
204H	10	5/16"
205H	11	5/16"
107H, 107BX48	15	5/16"

Basic Bearing Number	Ball Complement	
	Number	Diameter
108H, 108BX48	17	5/16"
302H	9	11/32"
303H	10	11/32"
109H	16	3/8"
110H, 110BX48	18	3/8"
304H	9	13/32"
206H	11	13/32"
207H	12	7/16"
113BX48	18	7/16"
113H	19	7/16"
305H	10	15/32"
208H	12	15/32"
209H	13	15/32"
210H	14	1/2"
115H	20	1/2"
306H	10	17/32"
307H	11	9/16"
211H	14	9/16"
117BX48	20	9/16"
117H	21	9/16"
308H	11	5/8"
212H	14	5/8"
118H	19	5/8"
309H	11	11/16"
214H	15	11/16"
310H	11	3/4"
312H	12	7/8"
220H	15	1"

Preloading

Preloading is the removal of internal clearance in a bearing by applying a permanent thrust load to it.

Preloading:

- **ELIMINATES RADIAL AND AXIAL PLAY.**
- **INCREASES SYSTEM RIGIDITY.**
- **REDUCES NON-REPETITIVE RUNOUT.**
- **LESSENS THE DIFFERENCE IN CONTACT ANGLES BETWEEN THE BALLS AND BOTH INNER AND OUTER RINGS AT VERY HIGH SPEEDS.**
- **PREVENTS BALL SKIDDING UNDER VERY HIGH ACCELERATION.**

Bearing Yield

Axial yield is the axial deflection between inner and outer rings after end play is removed and a working load or preload is applied. It results from elastic deformation of balls and raceways under thrust loading.

Radial yield, similarly, is the radial deflection caused by radial loading. Both types of yield are governed by the internal design of the bearing, the contact angle and load characteristics (magnitude and direction).

When a thrust load is applied to a bearing, the unloaded point-to-point contacts of balls and raceways broaden into elliptical contact areas as balls and raceways are stressed. All balls share this thrust load equally.

The radial yield of a loaded angular contact bearing is considerably less than the axial yield. Radial loading tends to force the balls on the loaded side of the bearing toward the bottom of both inner and outer raceways — a relatively small displacement. Thrust loading tends to make the balls climb the sides of both raceways with a wedging action. Combined with the contact angle, this causes greater displacement than under radial loading.

Zero load is the point at which only sufficient takeup has been applied to remove radial and axial play. Bearing yield is non-linear, resulting in diminishing yield rates as loads increase. This is because larger contact areas are developed between the balls and raceways. If the high initial deflections are eliminated, further yield under applied external loads is reduced. This can be achieved by axial preloading of bearing pairs.

Not only are yields of preloaded pairs lower, but their yield rates are essentially constant over a substantial range of external loading, up to approximately three times the rigid preload, at which point one of the bearings unloads completely.

Specific yield characteristics may be achieved by specifying matched preloaded pairs or by opposed mounting of two bearings. Consult Barden Product Engineering for yield rate information for individual cases.

Preloading Techniques

Bearings should be preloaded as lightly as is necessary to achieve the desired results. This avoids excessive heat generation, which reduces speed capability and bearing life. There are three basic methods of preloading: springs, axial adjustment and duplex bearings.

Fig. 6. Different types of spring preloading.

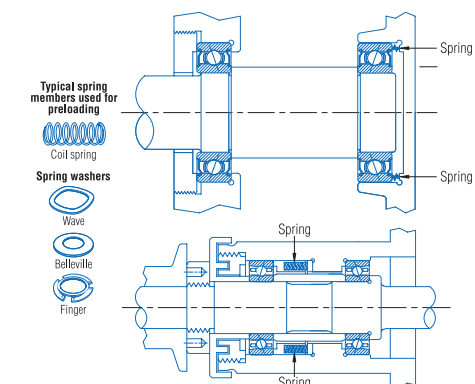

Spring

This is often the simplest method and should be considered first. Spring preloading provides a relatively constant preload because it is less sensitive to differential thermal expansion than rigid preloading and accommodates minor misalignment better. Also, it is possible to use bearings which have not been preload ground.

Many types of springs may be used (see Fig. 6), among them coil springs and Belleville, wave or finger spring washers. Usually the spring is applied to the non-rotating part of the bearing - typically the outer ring. This ring must have a slip fit in the housing at all temperatures.

Preloading

A disadvantage of this method is that spring preloading cannot accept reversing thrust loads. Space must also be provided to accommodate both the springs and spring travel, and springs may tend to misalign the ring being loaded.

■ Fig. 7. Axial adjustment.

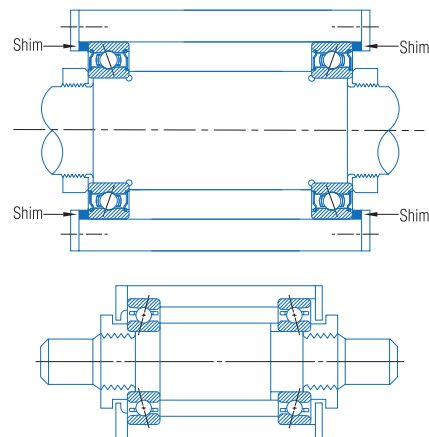

Axial Adjustment

Axial adjustment calls for mounting at least two bearings in opposition so that the inner and outer rings of each bearing are offset axially (see Fig. 7). Threaded members, shims and spacers are typical means of providing rigid preloads through axial adjustment.

This technique requires great care and accuracy to avoid excessive preloading, which might occur during setup by overloading the bearings, or during operation due to thermal expansion. Precision lapped shims are usually preferable to threaded members, because helical threads can lead to misalignment.

For low torque applications such as gyro gimbals, an ideal axial adjustment removes all play, both radial and axial, but puts no preload on either bearing under any operating condition.

The shims should be manufactured to parallelism tolerances equal to those of the bearings, because they must be capable of spacing the bearings to accuracies of one to two micrometers or better. Bearing ring faces must be well aligned and solidly seated, and there must be extreme cleanliness during assembly.

Duplex Bearings

Duplex bearings are matched pairs of bearings with built-in means of preloading. The inner or outer ring faces of these bearings have been selectively relieved a precise amount called the preload offset.

When the bearings are clamped together during installation, the offset faces meet, establishing a permanent preload in the bearing set. Duplex bearings are usually speed-limited due to heat generated by this rigid preload.

Duplexing is used to greatly increase radial and axial rigidity. Duplex bearings can withstand bi-directional thrust loads (DB and DF mounting) or heavy uni-directional thrust loads (DT mounting). Other advantages include their ease of assembly and minimum runout.

Some drawbacks of duplex bearings include:

- **INCREASED TORQUE.**
- **REDUCED SPEED CAPACITY.**
- **SENSITIVITY TO DIFFERENTIAL THERMAL EXPANSION.**
- **SUSCEPTIBILITY TO GROSS TORQUE VARIATIONS DUE TO MISALIGNMENT.**
- **POOR ADAPTABILITY TO INTERFERENCE FITTING.**

For a given Barden duplex pair, bore and O.D. are matched within 0.0025mm, therefore, duplex sets should not be separated or intermixed. High points of eccentricity are marked on both inner and outer rings. The high points should be aligned during assembly (inner to inner, outer to outer) to get a smoother, cooler and more accurate running spindle.

Most Barden deep groove and angular contact bearings are available in duplex sets. Deep groove bearings are usually furnished in specific DB, DF or DT configurations. Larger spindle and turbine angular contact bearings of Series 100, 200 and 300 are available with light, medium and heavy preloads (Table 24). Specific applications may require preload values that are non-standard. Please consult our Product Engineering Department if you need help with preload selection.

DB mounting (back-to-back)

This configuration is suited for most applications having good alignment of bearing housings and shafts. It is also preferable where high moment rigidity is required, and where the shaft runs warmer than the housing.

Inner ring abutting faces of DB duplex bearings are relieved. When they are mounted and the inner rings clamped together, the load lines (lines through points of ball contact) converge outside the bearings, resulting in increased moment rigidity.

■ Fig. 8. DB mounting.

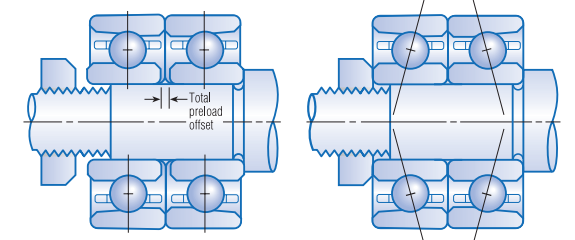

DF mounting (face-to-face)

DF mounting is used in few applications — mainly where misalignment must be accommodated. Speed capability is usually lower than a DB pair of identical preload.

Outer ring abutting faces of DF duplex bearings are relieved. When the bearings are mounted and the outer rings clamped together, the load lines converge toward the bore.

■ Fig. 9. DF mounting.

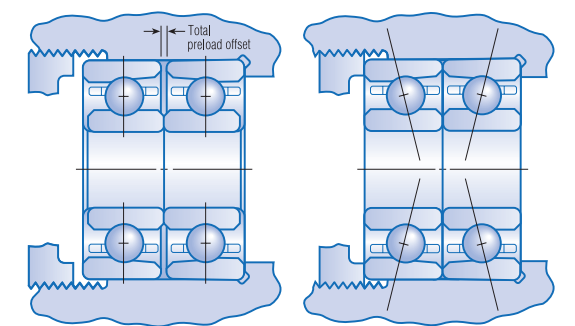

DT mounting (tandem)

DT pairs offer greater capacity without increasing bearing size, through load sharing. They can counter heavy thrust loads from one direction, but they cannot take reversing loads as DB and DF pairs can. However, DT pairs are usually opposed by another DT pair or a single bearing.

Abutting faces of DT pairs have equal offsets, creating parallel load lines. When mounted and preloaded by thrust forces, both bearings share the load equally.

■ Fig. 10. DT mounting.

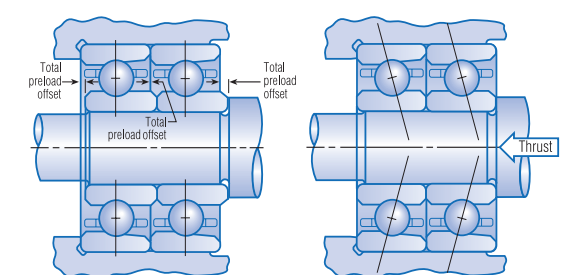

Engineering

Preloading

Duplex Bearing Spacers

All duplex pairs can be separated by equal width spacers to increase moment rigidity. Inner and outer ring spacer widths (axial length) must be matched to within .0001" (.0025mm); their faces must be square with the bore and outside cylindrical surface, flat and parallel within .0001" (.0025mm) to preserve preload and alignment. Custom designed spacers can be supplied with bearings as a matched set.

Fig. 11. Duplex bearing pairs with equal width spacers.

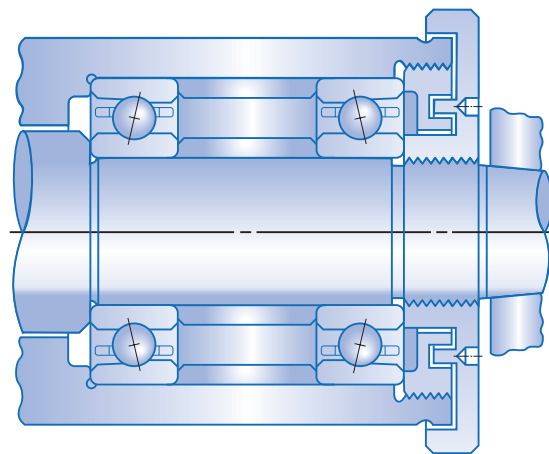

Table 22. Standard preloads (lbs) for Barden deep groove bearings: Series 100 and 200.

Bore Size	Series 100	Series 200
	M (Medium)	M (Medium)
10	10	12
12	10	14
15	13	17
17	18	22
20	20	30
25	25	35
30	35	50
35	40	70
40	45	85
45	70	90
50	75	110
55	90	145

Fig. 12. Increased stiffness can be achieved by mounting bearings in sets.

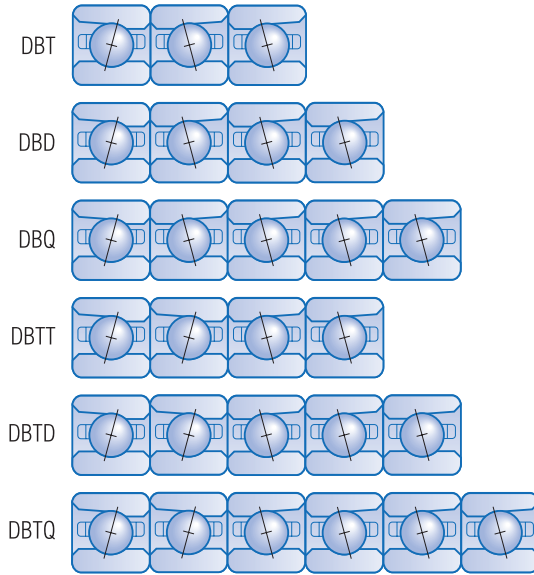

Table 23. Standard preloads (lbs) for Barden miniature and instrument angular contact bearings.

Basic Bearing Number	Bearing Nomenclature		Standard Preload (lbs)
	Separable B	Non-separable H	
R1-5	R1-5B	R1-5H	1
R144	-	R144H	0.5
R2-5	R2-5B	R2-5H	2
R2	R2B	R2H	2
R2-6	-	R2-6H	2
R3	R3B	R3H	2
R4	R4B	R4H	2
R4HX8	-	R4HX8	6
R8	-	R8H	8
2M3BY3	2M3BY3	-	2
34	-	34H	6
34BX4	34BX4	-	6
34-5	34-5B	34-5H	6
19M5	19M5B	-	2
36BX1	36BX1	-	6
37	-	37H	13
38	-	38H	13
38BX2	38BX2	-	13
39	-	39H	15

Table 24. Standard preloads (lbs) for Barden angular contact bearings: Series 100, 200 and 300.

Bore Size	Series 100 (H) (B) (I)			Series 200 (H) (B) (I)			Series 300 (H) (B) (I)		
	L (Light)	M (Medium)	H (Heavy)	L (Light)	M (Medium)	H (Heavy)	L (Light)	M (Medium)	H (Heavy)
0	4	10	20	6	15	30	10	25	50
1	5	12	24	7	17	35	10	25	50
2	5	13	26	8	20	40	12	30	60
3	6	15	30	10	25	50	20	45	90
4	10	25	50	15	35	70	20	55	110
5	12	30	60	15	40	80	30	80	160
6	15	40	80	25	65	130	40	100	200
7	20	50	100	30	80	160	50	125	250
8	25	60	120	40	95	190	65	160	320
9	30	80	160	40	100	200	75	190	380
10	35	85	170	50	125	250	90	230	460
11	50	120	240	65	160	320	110	270	540
12	50	130	260	80	200	400	130	320	640
13	50	130	260	100	250	500	150	370	740
14	65	160	320	100	260	520	170	420	840
15	70	170	340	100	260	520	180	460	920
16	90	220	440	120	310	620	210	530	1160
17	90	230	460	150	370	740	260	660	1320
18	110	280	560	160	400	800	260	660	1320
19	120	290	580	190	470	940	320	800	1600
20	130	310	620	220	540	1080	-	-	-
21	150	360	720	230	570	1140	-	-	-
22	150	390	780	280	670	1340	-	-	-
24	170	420	840	-	-	-	-	-	-
26	230	560	1120	-	-	-	-	-	-
28	250	620	1240	-	-	-	-	-	-
30	280	700	1400	-	-	-	-	-	-

Table 25. Standard preloads (lbs) for Barden Series 1900 angular contact bearings.

Bore Size	Series 1900 (H)		
	L (Light)	M (Medium)	H (Heavy)
12	4	9	18
15	4	10	20
25	8	20	40
35	12	30	65

Engineering

Lubrication

Adequate lubrication is essential to the successful performance of anti-friction bearings. Increased speeds, higher temperatures, improved accuracy and reliability requirements result in the need for closer attention to lubricant selection. Lubricant type and quantity have a marked effect on functional properties and service life of each application. Properly selected lubricants:

Properly selected lubricants:

- **REDUCE FRICTION BY PROVIDING A VISCOUS HYDRODYNAMIC FILM OF SUFFICIENT STRENGTH TO SUPPORT THE LOAD AND SEPARATE THE BALLS FROM THE RACEWAYS, PREVENTING METAL-TO-METAL CONTACT.**
- **MINIMIZE CAGE WEAR BY REDUCING SLIDING FRICTION IN CAGE POCKETS AND LAND SURFACES.**
- **PREVENT OXIDATION/CORROSION OF ROLLING ELEMENTS.**
- **ACT AS A BARRIER TO CONTAMINANTS.**
- **SERVE AS A HEAT TRANSFER AGENT IN SOME CASES, CONDUCTING HEAT AWAY FROM THE BEARING.**

Lubricants are available in three basic forms:

- **FLUID LUBRICANTS (OILS).**
- **GREASES — SOLID TO SEMI-SOLID PRODUCTS CONSISTING OF AN OIL AND A THICKENING AGENT.**
- **DRY LUBRICANTS, INCLUDING FILMS. DRY FILM LUBRICATION IS USUALLY LIMITED TO MODERATE SPEED AND VERY LIGHT LOADING CONDITIONS. FOR MORE INFORMATION, SEE SURFACE ENGINEERING SECTION (PAGES 73–74).**

Fig. 13. Lubrication Regimes.

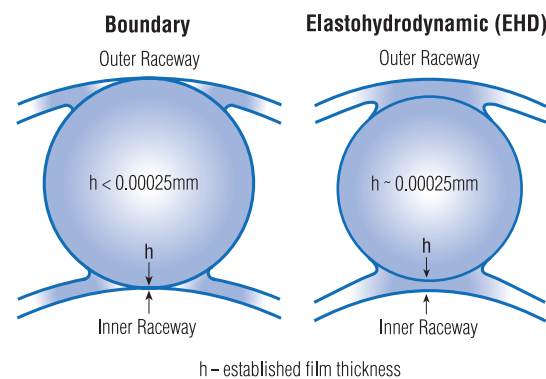

Viscosity graph for several typical oil lubricants.

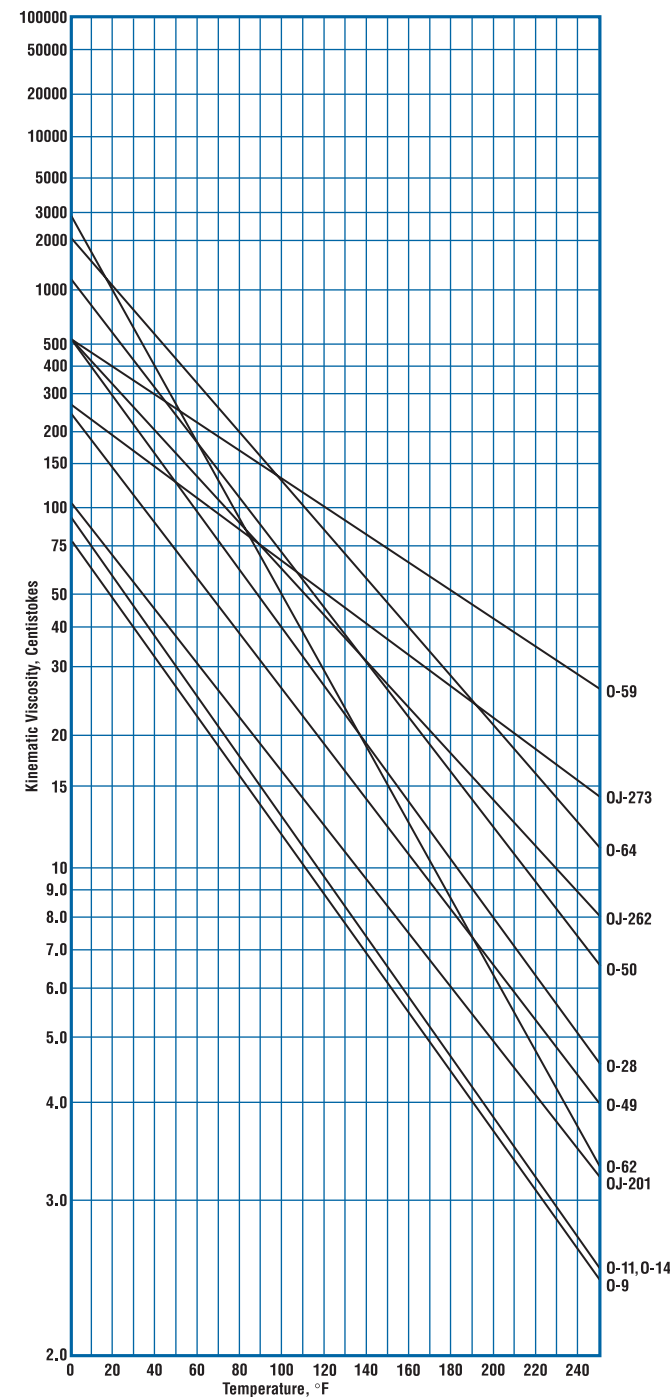

Viscosity graph for several typical grease lubricants.

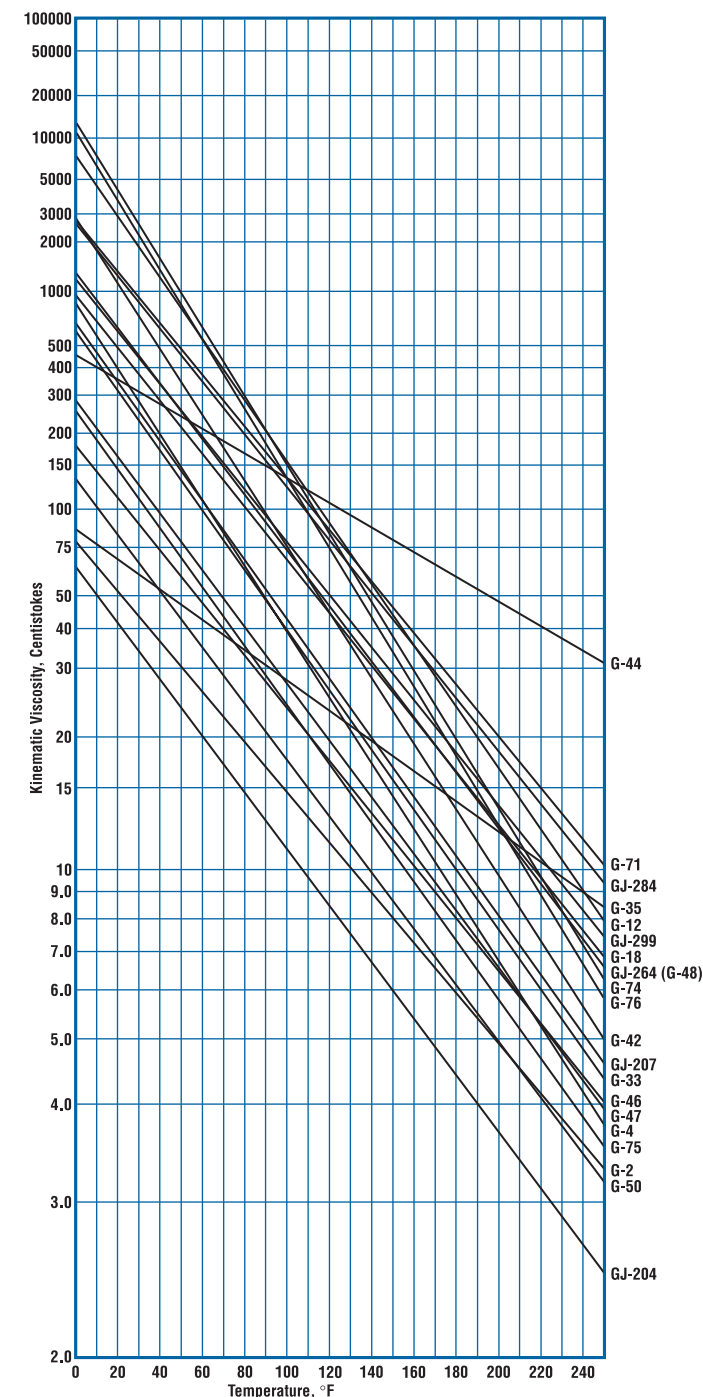

Barden Lubrication Practices

Factory pre-lubrication of bearings is highly recommended, since the correct quantity of applied lubricant can be as important as the correct type of lubricant. This is especially true of greases, where an excess can cause high torque, overheating and — if the speed is high enough — rapid bearing failure.

Based on its lengthy experience in this field, Barden has established standard quantities of lubricants that are suitable for most applications. When grease is specified, Barden applies a predetermined amount of filtered grease to the appropriate bearing surfaces.

Barden bearings normally available from stock are furnished with the following standard lubricants:

Deep groove open bearings

Instrument sizes.....O-11

Spindle and turbine sizes.....O-67

Deep groove shielded or sealed

Instrument sizes.....G-2

Spindle and turbine sizes.....G-74

Angular contact bearings

Instrument sizes.....O-11

Spindle and turbine sizes.....O-67

Lubricant Selection

Selection of lubricant and method of lubrication are generally governed by the operating conditions and limitations of the system. Three of the most significant factors in selecting a lubricant are:

- **VISCOSITY OF THE LUBRICANT AT OPERATING TEMPERATURE.**
- **MAXIMUM AND MINIMUM ALLOWABLE OPERATING TEMPERATURES.**
- **TEMPERATURES.**
- **OPERATING SPEED.**

Tables 26 and 27 (pages 101 and 102) provide comparative reference data, including temperature ranges and speed limits, for several of the lubricants used by Barden.

Hydrodynamic films are generated with both oils and greases, but do not exist in a true sense with dry films. The formation of an elastohydrodynamic film depends mainly on bearing speed and lubricant

Engineering

Lubrication

viscosity at operating temperature. Computational methods for determining the effect of elastohydrodynamic films on bearing life are given on page 114 (calculating fatigue life).

The minimum viscosity required at operating temperature to achieve a full elastohydrodynamic film may be obtained from the following formula: Instrument bearings (Series R, R100, R1000, FR, 500 and 30)

$$V = \frac{1800 \times 10^6}{nCNC_p}$$

Spindle and turbine bearings (Series 1900, 100, 200, 300 and 9000)

$$V = \frac{6700 \times 10^6}{nCNC_p}$$

where

V = Viscosity in centistokes at operating temperature

C = Basic load rating in Newtons

N = Speed in rpm

n = Number of balls (see pages 90–92)

Cp = Load factor (see Figure 19, page 116)

Grease Considerations

The primary advantage of grease over oil is that bearings can be prelubricated with grease, eliminating the need for an external lubrication system. This grease is often adequate for the service life of the application, especially in extra-wide Series 9000 bearings which have greater than usual grease capacity.

Besides simplicity, grease lubrication also requires less maintenance and has less stringent sealing requirements than oil systems. Grease tends to remain in proximity to bearing components, metering its oil content to operating surfaces as needed.

On the other hand, grease can be expected to increase the initial bearing torque and may exhibit a slightly higher running torque. Other considerations:

Speedability. This is expressed as a dN value, with dN being the bearing bore in mm multiplied by RPM. The greatest dN that greases can normally tolerate for continuous operation is approximately 1,200,000. Speed limits for greases are generally

lower than for oils due to the plastic nature of grease that tends to cause overheating at high speed. Compared to circulating oil, grease has less ability to remove heat from bearings.

Temperature. Most greases are limited to a maximum temperature of 350°F, some only to 250°F or 200°F. Specially formulated high temperature greases can operate at 450°F or 500°F for short periods. For all greases, life is severely shortened by operation near their temperature limits.

Consistency (stiffness). Stiffer consistency greases are beneficial for applications with outer ring rotation where centrifugal force tends to sling grease out of the bearing, and those vertical axis applications (bearings installed horizontally) where gravity pulls grease away from its intended position.

Channeling type greases have the property of being displaced during initial running and maintaining a relatively fixed position during life. Other things being equal, high-speed torques with channeling greases will be lower. Non-channeling greases will tend to give high torque at low temperatures and high pumping losses at high temperatures.

Bleeding. Every grease has a tendency to “bleed” — that is, the oil component separates from its thickener. The amount of bleeding varies with the type of grease, its oil viscosity and thickener characteristics. This phenomenon requires consideration if there is a lengthy time before initial bearing usage or between periods of operation.

If bearings are installed in mechanisms which are used soon after assembly and are not subject to extended shutdowns, no problem is created.

Combination of factors. To maintain a normal grease life expectancy, adverse operating conditions must not be present in combination. Thus, at temperatures near the upper limit for a given grease, speed and load should be low. Or, at maximum speeds, temperature and load should be low.

In certain applications, such combinations are unavoidable and trade-offs are necessary. For example, if speed and temperature are both high, loads must be low and life will be short.

Table 26. Typical oil lubricants recommended for use in Barden Precision Bearings.

Barden Code	Designation	Base Oil	Operating Temperature Range °F	Maximum dN	Comments
0-11	Winsorlube L-245X	Diester	-65 to 175	1,500,000*	Attacks paint, neoprene, anti-corrosion additives. MIL-L-6085.
0-14	Exxon Turbo Oil #2389	Diester	-65 to 350	1,500,000*	Anti-oxidation, additives, MIL-L-7808.
0-28	Exxon Spectrasyn 6	Synthetic hydrocarbon	-65 to 350	1,500,000*	Good heat stability, low volatility.
0-49	Exxon Turbo Oil #2380	Diester	-65 to 350	1,500,000*	Anti-oxidation additives, MIL-L-23699.
0-50	NYE Synthetic 181B	Synthetic hydrocarbon	-40 to 300	1,500,000*	Good heat stability, low volatility.
0-59	Bray Micronic 815Z	Perfluorinated polyether	-100 to 500	400,000	Low surface tension, but does not migrate.
0-62	Du Pont Krytox 1506	Fluorocarbons	-60 to 550	400,000	Low surface tension, but does not migrate.
0-64	NYE Synthetic Oil 2001	Synthetic hydrocarbon	-50 to 260	400,000	Instrument, general purpose lubricant excellent for use in hard vacuum applications where very low out gas properties are desired.
0-67	Anderol Royco 363	Petroleum	-65 to 150	1,500,000*	Anti-oxidation, anti-corrosion E.P. additives.
OJ-201	Aeroshell Fluid 12	Synthetic Ester	-65 to 300	1,500,000*	MIL-L-6085, Attacks paint, natural rubber, and neoprene. Contains anti-corrosion additives.
OJ-228	Nycolube 11B	Synthetic Ester	-65 to 300	1,500,000*	MIL-L-6085, Attacks paint, natural rubber, and neoprene. Contains anti-corrosion additives.
OJ-262	Anderol 465	Synthetic	-20 to 450	1,500,000*	Low out gas properties for wide temperature range. Contains anti-corrosion, and anti-oxidation additives. Contains anti-corrosion, anti-wear additives.
OJ-273	Nyosil M25	Silicone	-58 to 390	200,000	Low surface tension, tends to migrate.

*Max dN for continuous oil supply.

Grease thickeners. There are several types of thickeners, each with its own special characteristics and advantages for specific applications. The most common types of thickeners used in precision bearing applications are:

- **BARIUM COMPLEX: NON-CHANNELING, WATER RESISTANT.**
- **SODIUM: CHANNELING TYPE, WATER SOLUBLE, LOW TORQUE.**
- **LITHIUM: NON-CHANNELING, OFFERS GOOD WATER RESISTANCE, GENERALLY SOFT.**
- **POLYUREA: NON-CHANNELING, WATER RESISTANT, VERY QUIET RUNNING.**
- **CLAY: NON-CHANNELING, WATER RESISTANT, CAN BE NOISY IN MINIATURE AND INSTRUMENT BEARINGS.**
- **TEFLON: NON-CHANNELING, WATER RESISTANT, CHEMICAL INERTNESS, NON-FLAMMABLE, EXCELLENT OXIDATIVE AND THERMAL STABILITY.**

Grease Quantity. “If a little is good, more is better!” Not always true. Too much grease can cause ball skid, localized over-heating in the ball contact area, cage pocket wear, and rapid bearing failure

under certain conditions of operation. Generally, for precision high speed applications, grease quantity in a bearing should be about 20% to 30% full, based on the free internal space. This quantity may be modified to meet the requirements of the application regarding torque, life, and other specifics.

Grease Filtering. Greases for precision bearings are factory filtered to preclude loss of precision, noise generation, high torque, and premature failure in the application. There is no intermediate grease container following the filtering operation since the in-line filter injects the grease into the bearings immediately prior to bearing packaging.

Grease filter sizes range from about 10 to 40 microns depending on grease variables such as thickener and additive particle size.

Oil Considerations

While grease lubrication is inherently simpler than lubrication with oil, there are applications where oil is the better choice.

Lubrication

Table 27. Typical grease lubricants recommended for use in Barden Precision Bearings.

Barden Code	Designation	Base Oil	Thickener	Operating Temperature Range °F	Maximum dN*	Comments
G-2	Exxon Beacon 325	Diester	Lithium	-65 to 250	400,000	Good anti-corrosion, low torque.
G-4	NYE Rheolube 757SSG	Petroleum	Sodium	-40 to 200	650,000	Anti-oxidation additives, machine tool spindle grease.
G-12	Chevron SRI-2	Petroleum	Polyurea	-20 to 300	400,000	General purpose, moderate speed, water resistant.
G-18	NYE Rheotemp 500	Ester and petroleum	Sodium	-50 to 350	500,000	For high temperature, high speed. Not water resistant.
G-33	Mobil 28	Synthetic hydrocarbon	Clay	-80 to 350	400,000	MIL-G-81322, DOD-G-24508, wide temperature range.
G-35	Du Pont Krytox 240 AB	Perfluoro-alkylpolyether	Tetrafluoro-ethylenetelomer	-40 to 450	400,000	Excellent thermal oxidative stability, does not creep, water resistant and chemically inert.
G-44	Braycote 601 EF	Perfluorinated Polyether	Tetrafluoro-ethylenetelomer	-100 to 500	400,000	Excellent thermal and oxidative stability, does not creep, water resistant, chemically inert.
G-46	Kluber Isoflex NBU-15	Ester	Barium Complex	-40 to 250	700,000	Spindle bearing grease for maximum speeds, moderate loads.
G-47	Kluber Asonic GLY32	Ester/Synthetic Hydrocarbon	Lithium	-60 to 300	600,000	Quiet running spindle bearing grease for moderate speeds and loads.
G-50	Kluber Isoflex Super LDS 18	Ester/Mineral	Lithium	-60 to 250	850,000	Spindle bearing grease for maximum speed and moderate loads.
G-71	Rheolube 2000	Synthetic Hydrocarbon	Organic Gel	-50 to 260	400,000	Instrument, general purpose grease with good anti-corrosion, and anti-wear properties. Excellent for use in hard vacuum applications where very low outgassing properties are desired.
G-74	Exxon Unirex N3	Petroleum	Lithium	-40 to 300	650,000	Spindle bearing grease for moderate speeds and loads. Low grease migration. Good resistance to water washout and corrosion.
G-75	Arcanol L-75	PAO/Ester	Polyurea	-60 to 250	1,200,000	Spindle bearing grease for maximum speeds, moderate loads. Requires shorter run-in time than G-46.
G-76	Nye Rheolube 374C	Synthetic Hydrocarbon	Lithium	-40 to 300	650,000	Instrument, general purpose grease for moderate speeds and loads. Stiff, channeling grease with good resistance to water washout and corrosion.
GJ-204	Aeroshell Grease No 7	Synthetic Ester (Diester)	Microgel	-100 to 300	400,000	MIL-G-23827, general purpose aircraft, and instrument grease for heavy loads.
GJ-207	Aeroshell Grease No 22	Synthetic Hydrocarbon	Microgel	-85 to 400	400,000	MIL-G-81322, wide temperature range. Good low temperature torque.
GJ-264/G-48	Kluber Asonic GHY72	Ester Oil	Polyurea	-40 to 360	500,000	Quiet running grease for moderate speeds, and loads. Good resistance to water washout, and corrosion.
GJ-284	Kluber Asonic HQ 72-102	Ester Oil	Polyurea	-40 to 360	600,000	Quiet running grease for moderately high speeds and loads. Good resistance to water washout and corrosion.
GJ-341	Kluber Kluberquiet BQ74-73N	Synthetic Hydrocarbon Oil, Esteroil	Polyurea	-40 to 320	500,000	Quiet running grease for moderate speeds, and loads.

*Values shown can be achieved under optimum conditions. Applications approaching these values should be reviewed by Barden Product Engineering.

Lubrication

Instrument bearings with extremely low values of starting and running torque need only a minimal, one-time lubrication. Each bearing receives just a few milligrams of oil — a single drop or less.

In high-speed spindle and turbine applications, oil is continuously supplied and provides cooling as well as lubrication.

Speedability. Limiting speeds shown in the product tables (front of catalogue) for oil-lubricated bearings assume the use of petroleum or diester-based oils. These limits are imposed by bearing size and cage design rather than by the lubricant. The lubricant by itself can accommodate 1,500,000 dN or higher

In the case of silicone-based oils, the maximum speed rating drops to 200,000 dN. Similarly, when computing life for bearings lubricated with silicone-based oils, the Basic Load Rating (C) should be reduced by two-thirds (C/3).

For long life at high speeds, the lubrication system should provide for retention, circulation, filtration and possibly cooling of the oil. On all applications where speeds approach the upper limits, Barden Product Engineering should be consulted for application review and recommendations.

Oil Properties

Some of the key properties of oils include:

- **VISCOSITY. RESISTANCE TO FLOW.**
- **VISCOSITY INDEX. RATING OF VISCOSITY CHANGES AT VARYING TEMPERATURES.**
- **LUBRICITY. RATING OF SLIDING FRICTION AT BOUNDARY CONDITIONS* OF LUBRICATION.**
- **POUR POINT. LOWEST TEMPERATURE AT WHICH OIL WILL FLOW.**
- **OXIDATION RESISTANCE. RATING AN OIL'S RESISTANCE TO OXIDATION CAUSED BY HIGH TEMPERATURES, PRESENCE OF OXYGEN AND CATALYTIC METALS (ESPECIALLY COPPER).**
- **CORROSION RESISTANCE. RATING AN OIL'S ABILITY TO PROTECT BEARING FROM CORROSION.**
- **FLASH POINT. TEMPERATURE AT WHICH AN OIL GIVES OFF FLAMMABLE VAPORS.**
- **FIRE POINT. TEMPERATURE AT WHICH AN OIL BURNS IF IGNITED.**

*Boundary lubrication exists when less than a full elastohydrodynamic film is formed with resulting metal to metal contact — ball to raceway wear.

Oil Types

Oils used in bearings are of two general types — petroleum and synthetic — which are usually supplemented by additives to compensate for deficiencies or to provide special characteristics.

Petroleum Oils

Classified as naphthenic or paraffinic, depending on the crude oil source. Excellent general-purpose oils at normal temperatures (-40°F to 250°F). Additives are typically required to inhibit oxidation, corrosion, foaming and polymerization, and to improve viscosity index.

Synthetic Oils

Synthetic oils include the following:

Diesters. Synthetic oils developed for applications requiring low torque at subzero starting temperatures and higher operating temperatures. General temperature range: -75°F to 350°F.

Silicones. Synthetic compounds with a relatively constant viscosity over their temperature range. Used for very cold starting and low torque applications. Generally undesirable for high loads and speeds. General temperature range: -100°F to 450°F. Maximum dN rating of 200,000.

Fluorocarbons. Synthetic oils for corrosive, reactive or high temperature (up to 550°F) environments. Insoluble in most solvents. Excellent oxidative stability, low volatility. They provide poor protection against bearing corrosion. Designed for specific temperature ranges with several products used to cover from -70°F to 550°F.

Synthetic Hydrocarbons. These are fluids which are chemically reacted to provide performance areas superior to petroleum and other synthetic oils. These oils are useable over a wider temperature range than petroleum oils. They are less volatile, more heat resistant and oxidation-stable at high temperatures and are more fluid at low temperatures. General temperature range: -80°F to 300°F.

Lubrication

Oil Lubrication Systems

Oil-lubricated bearings usually requires a systems approach. The most common types of lubrication systems are:

Bath or Wick. Oil is fed to the bearing from a built-in reservoir by wicking, dripping or submerging the bearing partially in oil.

Splash. From a built-in reservoir, oil is distributed by a high-speed rotating component partially submerged in oil.

Jet. Oil is squirted into and through the bearing from an external source. Excellent where loads are heavy, speeds and temperatures are high. Efficiently applied flow of oil both lubricates and cools. Provision must be made to remove the oil after it passes through the bearing to prevent overheating.

For more information on lubrication windows/ nozzle placement see Fig. 16 and 17.

Fig. 14. Wick lubrication system.

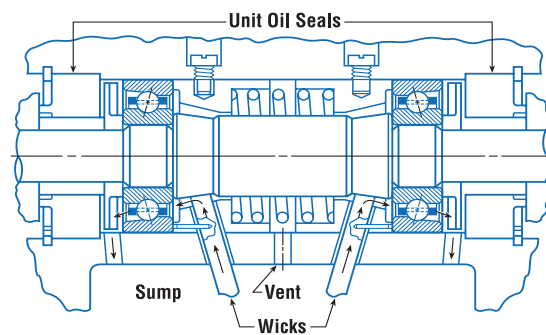
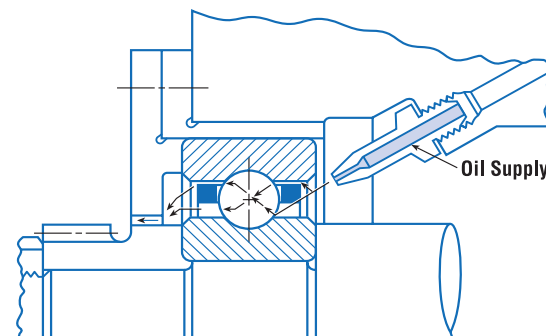

Fig. 15. Jet lubrication system.



Bearings with Direct Lubrication



For high speed oil lubricated applications, many bearing types can be supplied with radial lubrication holes to take oil in close proximity to the ball to raceway contact zones from the bearing OD. The number and size of the lubricating holes can be varied to suit each application, and these holes are connected by a radial oil distribution groove. O-rings on either side

of the distribution groove prevent losses, ensuring the correct quantity of oil is delivered to the correct area. Please Contact Barden's Product Engineering Department for further details.

Lubrication Windows

For those angular contact spindle bearings being lubricated by an air/oil or jet system, the following tables will guide the placement of the spray or jet.

Fig. 16. Lubrication window for H-type bearing.

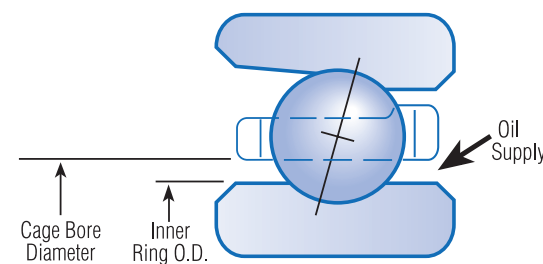

Fig. 17. Lubrication window for B-type bearings.

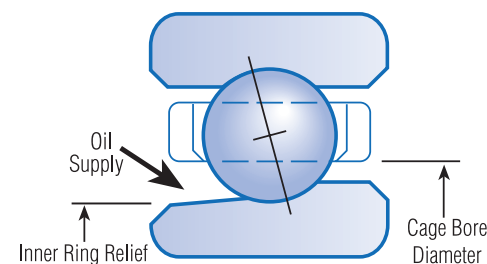

Table 28. Bearing lubrication window — 100H Series.

Bearing Size	Cage Bore Diameter (Inches)	Inner Ring O.D. (Inches)
100HJH	.731	.583
101HJH	.805	.670
102HJH	.902	.798
103HJH	1.022	.895
104HJH	1.236	1.050
105HJH	1.390	1.291
106HJH	1.652	1.511
107HJH	1.867	1.753
108HJH	2.073	1.939
109HJH	2.310	2.174
110HJH	2.487	2.372
111HJH	2.779	2.604
112HJH	2.970	2.832
113HJH	3.157	3.003
114HJH	3.534	3.259
115HJH	3.667	3.490
116HJH	3.922	3.754
117HJH	4.104	3.950
118HJH	4.396	4.217
119HJH	4.580	4.412
120HJH	4.777	4.609
121HJH	5.057	4.872
122HJH	5.355	5.121
124HJH	5.726	5.515
126HJH	6.314	6.043
128HJH	6.680	6.437
130HJH	7.145	6.930

Table 29. Bearing lubrication window — 300H Series.

Bearing Size	Cage Bore Diameter (Inches)	Inner Ring O.D. (Inches)
304HJH	1.415	1.217
305HJH	1.704	1.476
306HJH	1.994	1.742
307HJH	2.255	1.983
308HJH	2.583	2.28
309HJH	2.845	2.51
310HJH	3.142	2.775

Table 30. Bearing lubrication window — 200H Series.

Bearing Size	Cage Bore Diameter (Inches)	Inner Ring O.D. (Inches)
200HJH	.831	.656
201HJH	.917	.721
202HJH	1.023	.815
203HJH	1.121	.986
204HJH	1.328	1.130
205HJH	1.516	1.320
206HJH	1.816	1.616
207HJH	2.116	1.857
208HJH	2.288	2.130
209HJH	2.539	2.289
210HJH	2.730	2.460
211HJH	3.008	2.764
212HJH	3.314	2.975
213HJH	3.583	3.295
214HJH	3.791	3.495
215HJH	3.970	3.692
216HJH	4.247	3.954
217HJH	4.540	4.235
218HJH	4.826	4.483
220HJH	5.401	5.012

Table 31. Bearing lubrication window — B Series.

Bearing Size	Cage Bore Diameter (Inches)	Inner Ring O.D. (Inches)
101BX48	.700	.609
102BX48	.825	.737
103BX48	.915	.837
104BX48	1.095	.969
105BX48	1.281	1.166
106BX48	1.590	1.408
107BX48	1.750	1.596
108BX48	1.945	1.813
110BX48	2.390	2.183
113BX48	2.995	2.811
117BX48	3.954	3.668

Engineering

Tolerances and Geometric Accuracy

ABEC classes for precision ball bearings define tolerances for major bearing dimensions and characteristics divided into mounting dimensions and bearing geometry. The bearing geometry characteristics are illustrated to the right.

In selecting a class of precision for a bearing application, the designer should consider three basic areas involving bearing installation and performance of the total mechanism:

1. How bearing bore and outside diameter variations affect:
 - a. Bearing fit with mating parts.
 - b. Installation methods, tools and fixtures necessary to install bearings without damage.
 - c. Radial internal clearance of mounted bearing.
 - d. Means of creating or adjusting preload.
 - e. Problems due to thermal changes during operation.
2. Allowable errors (runout) of bearing surfaces and:
 - a. Their relationship to similar errors in mating parts.
 - b. Their combined effect on torque or vibration.
3. Normally unspecified tolerances for the design, form or surface finish of both bearing parts and mating surfaces, which interact to affect bearing torque, bearing vibration and overall rigidity of the rotating mass.

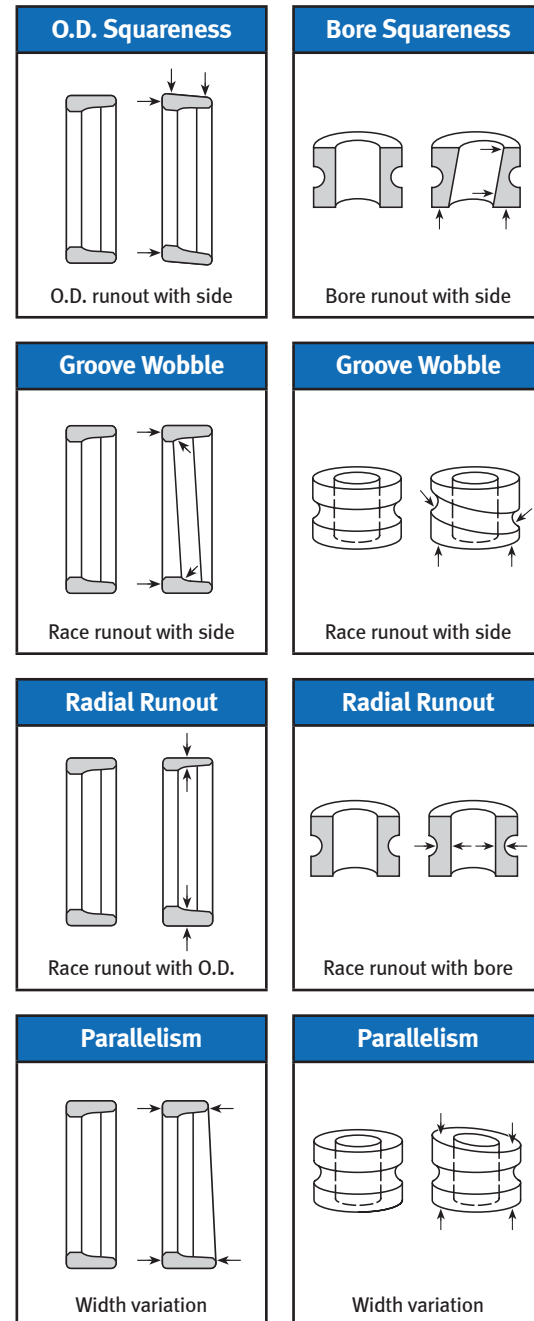

Exclusions From ABEC Standards

As useful as ABEC classes are for defining the levels of bearing precision, they are not all-inclusive. ABEC standards do not address many factors which affect performance and life, including:

- **MATERIALS.**
- **BALL COMPLEMENT — NUMBER, SIZE AND PRECISION.**
- **RACEWAY CURVATURE, ROUNDNESS AND FINISH.**
- **RADIAL PLAY OR CONTACT ANGLE.**
- **CAGE DESIGN.**
- **CLEANLINESS OF MANUFACTURING AND ASSEMBLY.**
- **LUBRICANT.**

Barden Internal Standards

Deep groove and angular contact instrument bearings are manufactured to ABEC 7P tolerances as defined by ABMA Standard 12.

Deep groove spindle and turbine size bearings are manufactured to ABEC 7 tolerances as defined by ABMA Standards 4 and 20 and ISO Standard 492.

Angular contact spindle and turbine size bearings are manufactured to ABEC 9 geometric tolerances. Mounting diameters (bore and OD) are measured and coded on every box. The tolerances conform to ABMA Standard 4 and 20 and ISO Standard 492.

To maintain a consistent level of precision in all aspects of its bearings, Barden applies internally developed standards to the important factors not controlled by ABEC.

Ball complement, shoulder heights, cage design and material quality are studied as part of the overall bearing design. Specialized component tolerances are used to check several aspects of inner and outer rings, including raceway roundness, cross race radius form and raceway finish.

The ABMA has generated grades of balls for bearings, but these are not specified in ABEC tolerance classes. Barden uses balls produced to both its own specifications by Winsted Precision Ball Company, and also to international standards.

After its self-established criteria have been applied to bearing design and component manufacturing, Barden performs functional testing of assembled bearings to be sure they exhibit uniform, predictable performance characteristics.

Special Tolerance Ranges

Barden can meet users' requirements for even tighter control of dimensions or functional characteristics than are specified in ABEC classifications. Working with customers, the Barden Product Engineering Department will set tolerances and performance levels to meet specific application needs.

Low Radial Runout Bearings

Especially for high-precision spindles, Barden can provide bearings with a very tight specification on radial runout. This condition is designated by use of suffix "E" in the bearing number. Consult Barden Product Engineering for details.

Engineering

Tolerance Tables

Table 32. Tolerances for bearing inner rings. All tolerances are in microns.

Inner Ring	Tolerance Description		ABEC 7P		A500		ABEC 5T			ABEC 7T			ABEC 7						ABEC 9							
			Over	18	15	34	9	18	30	9	18	30	0.6	10	18	30	50	80	120	0.6	10	18	30	50	80	
	Inner diameter, d, mm	Including	18	30	34	40	18	30	45	18	30	45	10	18	30	50	80	120	180	10	18	30	50	80	120	
Single plane mean bore diameter deviation (3)	Δ_{dmp}	max	0	0	0	0	0	0	0	0	0	0	0	0	0	0	0	0	0	0	0	0	0	0	0	0
		min	-5	-5	-7.6	-7.6	-5	-5	-7.6	-5	-5	-5	-4	-4	-5	-6	-7	-8	-10	-2.5	-2.5	-2.5	-2.5	-4	-5	
Deviation of a single bore diameter	Δ_{ds}	Thin series or Standard (1)	max	0	0	0	0	+2.5	+2.5	+2.5	0	+1.3	+2.5	0	0	0	0	0	0	0	0	0	0	0	0	0
			min	-5	-5	-7.6	-7.6	-7.6	-7.6	-10.2	-5.1	-6.4	-7.6	-4	-4	-5	-6	-7	-8	-10	-2.5	-2.5	-2.5	-2.5	-4	-5
		Extra thin series (1)	max					+2.5	+5.1	+7.6	0	+2.5	+5.1													
			min					-7.6	-10.2	-15.2	-5.1	-7.6	-10.2													
Bore diameter variation in a single radial plane	V_{dp}	max	2.5	2.5	5	5							3	3	4	5	5	6	8	2.5	2.5	2.5	2.5	4	5	
Mean bore diameter variation	V_{dmp}	max	2.5	2.5	5	5							2	2	2.5	3	3.5	4	5	1.5	1.5	1.5	1.5	2	2.5	
Deviation of a single ring width	Δ_{Bs}	max	0	0	0	0	0	0	0	0	0	0	0	0	0	0	0	0	0	0	0	0	0	0	0	
		min	-25	-25	-25	-25	-25	-25	-127	-25	-25	-25	-40	-80	-120	-120	-150	-200	-250	-40	-80	-120	-120	-150	-200	
		min - mod (2)	-400	-400	-381	-381	-400	-400	-500	-400	-400	-500	-250	-250	-250	-250	-250	-380	-380							
Ring width variation	V_{Bs}	max	2.5	2.5	2.5	2.5	5.1	5.1	5.1	2.5	2.5	2.5	2.5	2.5	2.5	3	4	4	5	1.5	1.5	1.5	1.5	1.5	2.5	
Radial runout	K_i	max	2.5	3.8	3.8	3.8	5.1	5.1	7.6	2.5	3.8	3.8	2.5	2.5	3	4	4	5	6	1.5	1.5	2.5	2.5	2.5	2.5	
Bore runout with side	S_d	max	2.5	3.8	5	7.6	7.6	7.6	7.6	2.5	3.8	3.8	3	3	4	4	5	5	6	1.5	1.5	1.5	1.5	1.5	2.5	
Inner ring face runout with raceway	S_i	max	2.5	3.8	5	5	7.6	7.6	7.6	2.5	3.8	3.8	3	3	4	4	5	5	7	1.5	1.5	2.5	2.5	2.5	2.5	

(1) 'Thin series' and 'Extra thin series' apply to ABEC 5T and ABEC 7T tolerances only, 'Standard' applies to all other tolerances.
 (2) Applies to bearings modified to have built-in preload. For ABEC 7P, 5T, 7T and A500, width tolerance applies to a duplex pair.
 For ABEC 7 and 9 the width tolerance applies to a single bearing. For additional bearings deviation is proportional to number of bearings.
 (3) Mean diameter = $\frac{1}{2}$ (maximum diameter + minimum diameter).

All diameter measurements are two point measurements.
 Tolerances apply in component form and are approximately true in assembled bearings.
 Tolerance table is a summary of relevant parts of the various tolerance standards.
 Some minor differences in exact definitions may exist between the table and tolerance standards.

Tolerance Tables

Table 33. Tolerances for bearing outer rings. All tolerances are in microns.

Tolerance Description	Outer diameter, D, mm		ABEC 7P			A500		ABEC 5T			ABEC 7T			ABEC 7							ABEC 9										
			Over	0	18	30	26	45	14	28	50	14	28	50	2.5	18	30	50	80	120	150	180	250	2.5	18	30	50	80	120	150	
	Including	18	30	50	45	51	28	50	80	28	50	80	18	30	50	80	120	150	180	250	315	18	30	50	80	120	150	180			
Single plane mean outside diameter deviation (3)	Δ_{Dmp}	max	0	0	0	0	0	0	0	0	0	0	0	0	0	0	0	0	0	0	0	0	0	0	0	0	0	0	0	0	
		min	-5	-5	-5	-10.2	-10.2	-5	-10	-10	-5	-5	-7.6	-4	-5	-6	-7	-8	-9	-10	-11	-13	-2.5	-4	-4	-4	-5	-5	-7		
Deviation of a single outside diameter	Δ_{Ds}	Open thin series or Standard (1)	max	0	0	0	0	0	+2.5	+2.5	+2.5	0	+2.5	+2.5	0	0	0	0	0	0	0	0	0	0	0	0	0	0	0	0	
			min	-5	-5	-5	-10.2	-10.2	-7.6	-12.7	-12.7	-5.1	-7.6	-10.2	-4	-5	-6	-7	-8	-9	-10	-11	-13	-2.5	-4	-4	-4	-5	-5	-7	
		Open extra thin series (1)	max							+2.5	+7.6	+10.2	0	+5.1	+7.6																
			min							-7.6	-17.8	-20.3	-5.1	-10.2	-15.2																
	Δ_{Dss}	Shielded thin series or Standard (1)	max	1	1	1	2.5	5	+5.1	+5.1	+5.1	+2.5	+5.1	+5.1																	
			min	-6	-6	-6	-12.7	-15.2	-10.2	-15.2	-15.2	-7.6	-10.2	-12.7																	
Shielded extra thin series (1)		max							+5.1	+10.2	+12.7	+2.5	+7.6	+10.2																	
		min							-10.2	-20.3	-22.9	-7.6	-12.7	-17.8																	
Outside diameter variation in a single radial plane	V_{Dp}	Open bearings	max	2.5	2.5	2.5	5	5							3	4	5	5	6	7	8	8	10	2.5	4	4	4	5	5	7	
		Shielded bearings	max	5	5	5	5	5																							
Mean outside diameter variation	V_{Dmp}	Open bearings	max	2.5	2.5	2.5	5	5							2	2.5	3	3.5	4	5	5	6	7	1.5	2	2	2	2.5	2.5	3.5	
		Shielded bearings	max	5	5	5	5	5																							
Deviation of a single ring width	Δ_{Cs}	max	0	0	0	0	0	identical to inner ring			identical to inner ring			identical to inner ring							identical to inner ring										
		min	-25	-25	-25	-25	-25	identical to inner ring			identical to inner ring			identical to inner ring							identical to inner ring										
		min - mod (2)	-400	-400	-400	-381	-381	identical to inner ring			identical to inner ring			identical to inner ring							identical to inner ring										
Ring width variation	V_{Cs}	max	5.1	5.1	5.1	2.5	2.5	5.1	5.1	5.1	2.5	2.5	3.8	2.5	2.5	2.5	3	4	5	5	7	7	1.5	1.5	1.5	1.5	2.5	2.5	2.5		
Radial runout	K_e	max	3.8	3.8	5.1	3.8	5	5.1	7.6	7.6	3.8	5.1	5.1	3	4	5	5	6	7	8	10	11	1.5	2.5	2.5	4	5	5	5		
Outside diameter runout with side	S_D	max	3.8	3.8	3.8	5	5	7.6	7.6	7.6	3.8	3.8	3.8	4	4	4	4	5	5	5	7	8	1.5	1.5	1.5	1.5	2.5	2.5	2.5		
Outer ring face runout with raceway	S_e	max	5.1	5.1	5.1	7.6	10.2	7.6	7.6	10.2	5.1	5.1	7.6	5	5	5	5	6	7	8	10	10	1.5	2.5	2.5	4	5	5	5		
Flange back face runout with raceway	S_{e1}	max	7.6	7.6	7.6																										
Flange width variation	V_{C1}	max	2.5	2.5	2.5																										
Deviation of a single flange outside diameter	Δ_{D1s}	min	0	0	0																										
		max	-25	-25	-25																										
Deviation of a single width of the outer ring flange	Δ_{C1s}	min	0	0	0																										
		max	-50	-50	-50																										

(1) 'Thin series' and 'Extra thin series' apply to ABEC 5T and ABEC 7T tolerances only, 'Standard' applies to all other tolerances.
 (2) Applies to bearings modified to have built in preload. For ABEC 7P, 5T, 7T and A500, width tolerance applies to a duplex pair.
 For ABEC 7 and 9 the width tolerance applies to a single bearing. For additional bearings deviation is proportional to number of bearings.
 (3) Mean diameter = $\frac{1}{2}$ (maximum diameter + minimum diameter).

All diameter measurements are two point measurements.
 Tolerances apply in component form and are approximately true in assembled bearings.
 Tolerance table is a summary of relevant parts of the various tolerance standards.
 Some minor differences in exact definitions may exist between the table and tolerance standards.

Engineering

Bearing Performance

Bearing Life

The useful life of a ball bearing has historically been considered to be limited by the onset of fatigue or spalling of the raceways and balls, assuming that the bearing was properly selected and mounted, effectively lubricated and protected against contaminants.

This basic concept is still valid, but refinements have been introduced as a result of intensive study of bearing failure modes. Useful bearing life may be limited by reasons other than the onset of fatigue.

Service Life

When a bearing no longer fulfills minimum performance requirements in such categories as torque, vibration or elastic yield, its service life may be effectively ended.

If the bearing remains in operation, its performance is likely to decline for some time before fatigue spalling takes place. In such circumstances, bearing performance is properly used as the governing factor in determining bearing life.

Lubrication can be an important factor influencing service life. Many bearings are prelubricated by the bearing manufacturer with an appropriate quantity of lubricant. They will reach the end of their useful life when the lubricant either migrates away from the bearing parts, oxidizes or suffers some other degradation. At that point, the lubricant is no longer effective and surface distress of the operating surfaces, rather than fatigue, is the cause of failure. Bearing life is thus very dependent upon characteristics of specific lubricants, operating temperature and atmospheric environment.

Specific determination of bearing life under unfavorable conditions can be difficult, but experience offers the following guidelines to achieve better life.

1. Reduce load. Particularly minimize applied axial preload.
2. Decrease speed to reduce the duty upon the lubricant and reduce churning.
3. Lower the temperature. This is important if lubricants are adversely affected by oxidation, which is accelerated at high temperatures.
4. Increase lubricant supply by improving reservoir provisions.
5. Increase viscosity of the lubricant, but not to the point where the bearing torque is adversely affected.
6. To reduce introduction of contaminants, substitute sealed or shielded bearings for open bearings and use extra care in installation.
7. Improve alignment and fitting practice, both of which will reduce duty on the lubricant and tend to minimize wear of bearing cages.

The most reliable bearing service life predictions are those based on field experience under comparable operating and environmental conditions.

Bearing Capacity

Three different capacity values are listed in the product section for each ball bearing. They are:

- **C – BASIC DYNAMIC LOAD RATING.**
- **C₀ – STATIC RADIAL CAPACITY.**
- **T₀ – STATIC THRUST CAPACITY.**

All of these values are dependent upon the number and size of balls, contact angle, cross race curvature and material.

Basic dynamic load rating, C, is based on fatigue capacity of the bearing components. The word dynamic denotes rotation of the inner ring while a stationary radial load is applied. The C value is used to calculate bearing fatigue life in the equation:

$$L_{10} = \left(\frac{C}{P}\right)^3 \times 10^6 \text{ revolutions.}$$

L₁₀ = Minimum fatigue life in revolutions for 90% of a typical group of apparently identical bearings.

P = Equivalent radial load.

Static radial capacity is based on ball-to-race contact stress developed by a radial load with both bearing races stationary. The static radial capacity, (C₀) of instrument bearings is the maximum radial load that can be imposed on a bearing without changing its performance characteristics, torque or vibration. It is based upon calculated stress values, assuming a maximum contact stress of 3.5 GPa (508,000 psi). (C₀) values for spindle and turbine bearings are based on a maximum contact stress of 4.2 GPa (609,000 psi).

Static thrust capacity, (T₀), is rated similarly to (C₀), with thrust loading developing the stress. The same mean and maximum stress levels apply.

In both radial and thrust loading, the stress developed between ball and raceway causes the point of contact to assume an elliptical shape. Theoretically, this contact ellipse should be

contained within the solid raceway. Thus, thrust capacity is ordinarily a function of either the maximum allowable stress or the maximum force that generates a contact ellipse whose periphery just reaches the raceway edge. However, for lightly loaded, shallow raceway bearings, the maximum load may be reached at very low stress levels. Testing has shown that, for such bearings, a minor extension of the contact ellipse past the raceway edge may be allowed without a loss in bearing performance.

During the bearing selection process, there may be several candidate bearings which meet all design requirements but vary in capacity. As a general rule, the bearing with the highest capacity will have the longest service life.

Engineering

Bearing Performance

Fatigue Life

The traditional concept that bearing life is limited by the onset of fatigue is generally accurate for bearings operating under high stress levels. Recent test data confirms that, below certain stress levels, fatigue life with modern clean steels can be effectively infinite. However, since many factors affect practical bearing life, Barden Product Engineering will be pleased to review applications where theoretical life appears to be inadequate. The traditional basic relationship between bearing capacity imposed loading and fatigue life is presented here.

$$L_{10} = \left(\frac{C}{P}\right)^3 \times 10^6 \text{ revolutions.}^* \text{ (Formula 1)}$$

In the above expression:

L_{10} = Minimum life in revolutions for 90% of a typical group of apparently identical bearings.

C = Basic Dynamic Load Rating.**

P = Equivalent Radial Load, computed as follows:

$$P = XR + YT \quad \text{(Formula 2)}$$

or

$$P = R \quad \text{(Formula 2)}$$

whichever is greater.

In the preceding equation:

R = Radial load.

T = Thrust load.

X = Radial load factor relating to contact angle.

Y = Axial load factor depending upon contact angle, T and ball complement.

For Basic Load Ratings, see product section tables.

For X and Y factors, see Tables 34 and 35.

*See ABMA Standard 9 for more complete discussion of bearing life in terms of usual industry concepts.

**For hybrid (ceramic ball) bearings, Basic Load Ratings and static capacities should be reduced by 30% to reflect the lower ball yield characteristic compared to the raceways. In practice the real benefits of hybrid bearings occur in the non-optimum operational conditions where fatigue life calculations are not applicable (see pages 70–72).

Table 34. Load factors for instrument bearings.

T/nd ²	Contact Angle, degrees			
	5	10	15	20
	Values of Axial Load Factor Y			
100	3.30	2.25	1.60	1.18
200	2.82	2.11	1.56	1.18
400	2.46	1.95	1.52	1.18
600	2.26	1.85	1.47	1.18
800	2.14	1.78	1.44	1.18
1200	1.96	1.68	1.39	1.18
2000	1.75	1.55	1.32	1.18
3000	1.59	1.45	1.27	1.18
4500	1.42	1.34	1.21	1.18
	Values of Radial Load Factor X			
	0.56	0.46	0.44	0.43

Table 35. Load factors for spindle and turbine bearings.

T/nd ²	Contact Angle, degrees				
	5	10	15	20	25
	Values of Axial Load Factor Y				
50	-	2.10	1.55	1.00	0.87
100	2.35	1.90	1.49	1.00	0.87
150	2.16	1.80	1.45	1.00	0.87
200	2.03	1.73	1.41	1.00	0.87
250	1.94	1.67	1.38	1.00	0.87
300	1.86	1.62	1.36	1.00	0.87
350	1.80	1.58	1.34	1.00	0.87
400	1.75	1.55	1.31	1.00	0.87
450	1.70	1.52	1.30	1.00	0.87
500	1.67	1.49	1.28	1.00	0.87
750	1.50	1.38	1.21	1.00	0.87
1000	1.41	1.31	1.17	1.00	0.87
1500	1.27	1.20	1.10	1.00	0.87
2000	1.18	1.13	1.05	1.00	0.87
2500	1.12	1.06	1.00	1.00	0.87
3000	1.07	1.02	1.00	1.00	0.87
3500	1.03	1.00	1.00	1.00	0.87
4000	1.00	1.00	1.00	1.00	0.87
4500	1.00	1.00	1.00	1.00	0.87
	Values of Radial Load Factor X				
	0.56	0.46	0.44	0.43	0.41

Note: Values of nd² are found in the product section. In tables, T=lbs.

Modifications to Formula 1 have been made, based on a better understanding of the causes of fatigue. Influencing factors include:

- AN INCREASED INTEREST IN RELIABILITY FACTORS FOR SURVIVAL RATES GREATER THAN 90%.
- IMPROVED RAW MATERIALS AND MANUFACTURING PROCESSES FOR BALL BEARING RINGS AND BALLS.
- THE BENEFICIAL EFFECTS OF ELASTOHYDRODYNAMIC LUBRICANT FILMS.

Formula 1 can be rewritten to reflect these influencing factors as:

$$L_{10} \text{ Modified} = (A_1)(A_2)(A_3) \frac{16,666}{N} \left(\frac{C}{P}\right)^3 \text{ hours.} \quad \text{(Formula 3)}$$

wherein:

L_{10} = Number of hours which 90% of a typical group of apparently identical bearings will survive.

N = Speed in rpm.

A_1 = Statistical life reliability factor for a chosen survival rate, from Table 36.

A_2 = Life modifying factor reflecting bearing material type and condition, from Table 37.

A_3 = Application factor, commonly limited to the elastohydrodynamic lubricant film factor calculated from formula 4 or 5. If good lubrication is assumed, $A_3 = 3$.

Factor A_1 . Reliability factors listed in Table 36 represent a statistical approach. In addition, there are published analyses that suggest fatigue failures do not occur prior to the life obtained using an A_1 factor of .05.

Table 36. Reliability factor A_1 for various survival rates.

Survival Rate (Percentage)	Bearing Life Notation	Reliability Factor A_1
90	L_{10}	1.00
95	L_5	0.62
96	L_4	0.53
97	L_3	0.44
98	L_2	0.33
99	L_1	0.21

Factor A_2 . While not formally recognized by the ABMA, estimated A_2 factors are commonly used as represented by the values in Table 37. The main considerations in establishing A_2 values are the material type, melting procedure, mechanical working and grain orientation, and hardness.

Note: SAE 52100 material in Barden bearings is vacuum processed, AISI 440C is air melted or vacuum melted — contact Barden Product Engineering for details.

Table 37. Life modifying factor A_2 .

Process	Material	440C	52100	M50	Cronidur 30®
Air Melt		.25X	NA	NA	NA
Vacuum processed		NA	1.0	NA	NA
VAR (CEVM)		1.25X	1.5X	NA	NA
VIM – VAR		1.5X	1.75X	2.0X	NA
PESR		NA	NA	NA	4.0X*

*Cronidur 30® steel is only used in conjunction with ceramic balls.

Factor A_3 . This factor for lubricant film effects is separately calculated for miniature and instrument (M&I) bearings and spindle and turbine (S&T) bearings as:

$$(M\&I) A_3 = 4.0 \times 10^{-10} n C N U C_p \quad \text{(Formula 4)}$$

$$(S\&T) A_3 = 8.27 \times 10^{-11} n C N U C_p \quad \text{(Formula 5)}$$

(The difference in constants is primarily due to the different surface finishes of the two bearing types.)

U = Lubrication Factor (from Figure 18, page 116)

n = number of balls (see pages 90–92)

C_p = Load Factor (from Figure 19)

In calculating factor A_3 , do not use a value greater than 3 or less than 1. (Outside these limits, the calculated life predictions are unreliable.) A value less than 1 presumes poor lubrication conditions. If A_3 is greater than 3, use 3.

Note: Silicone-based oils are generally unsuitable for speeds above 200,000 dN and require a 2/3 reduction in Basic Load Rating C.

Bearing Performance

Fig. 18. Lubrication factor U.

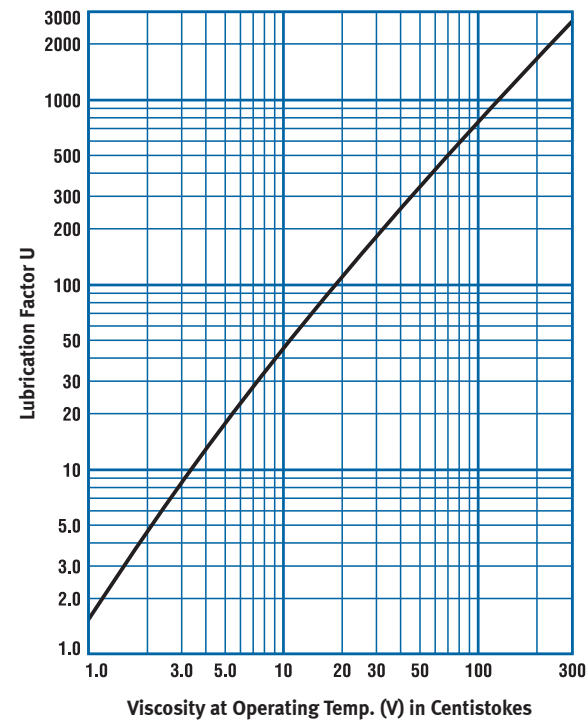

Sample Fatigue Life Calculation

Application Conditions

Application High-speed turbine
 Operating speed 40,000 RPM
 Rotating members Shaft, Inner Ring
 Lubrication Oil Mist, Winsor Lube L-245X (MIL-L-6085, Barden Code 0-11)
 Dead weight radial load 10lbs. (spaced equally on two bearings)
 Turbine thrust 20lbs.
 Thrust from preload spring .. 15lbs.
 Ambient temperature 160°F
 Tentative bearing choice 102HJH (vacuum processed SAE 52100 steel)

Fig. 19. Load factor Cp.

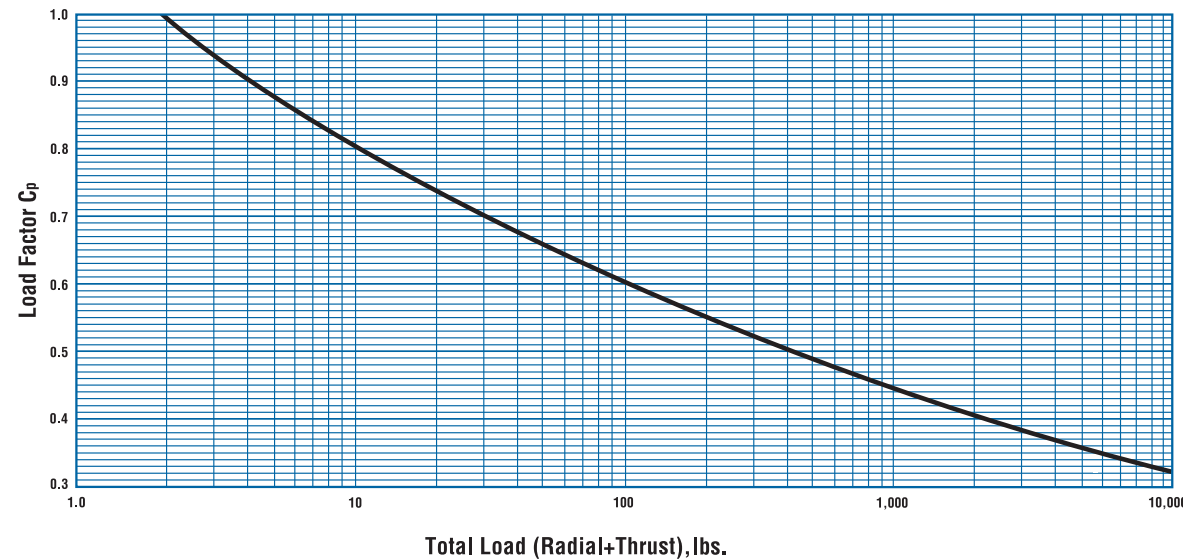

Step 1. Calculation of basic fatigue life in hours

Data for 102H (see product data section, pages 36-37):

$$C = 1404$$

$$nd^2 = 0.3867$$

$$\text{Contact angle} = 15^\circ$$

Total Thrust Load = 20 + 15 = 35 lbs

$$T/nd^2 = \frac{35}{.3867} = 90.51$$

Radial Load Per Bearing = 5 lbs

From Table 35, page 114:

$$X = 0.44$$

$$Y = 1.31$$

$$P = XR + YT = (.44)(5) + (1.31)(35) = 48.05$$

$$L_{10} = \frac{16,666}{40,000} \times \left(\frac{1404}{48.05}\right)^3 = 10,394 \text{ hours}$$

Answer: Basic fatigue life..... 10,394 hours

Step 2. Calculation of life modifying factors A₁-A₃

A₁ = 1 for L₁₀ from Table 36

A₂ = 1 for vacuum processed SAE 52100 from Table 37

A₃ = 3.68 × 10⁻¹⁰ n C N U Cp for spindle and turbine bearings

$$n = 11$$

$$C = 1404$$

$$N = 40,000$$

From graph on page 98, viscosity of Barden Code 0-11, 160°F = 5.7Cs

From Fig. 18, U = 20

Determine Cp, Load Factor, from Figure 19:
 Total Load (Radial + Thrust) = 5 + 35 = 40,
 Cp = 0.68

$$A_3 = 3.68 \times 10^{-10} \times 11 \times 1404 \times 40,000 \times 20 \times 0.68 = 3.092$$

Use maximum value of 3.0 for A₃.

Step 3. Calculation of modified fatigue life

$$L_{10} \text{ Modified} = A_1 A_2 A_3 L_{10} =$$

$$(1)(1)(3.00) 10,394 = 31,182 \text{ hours}$$

Answer: Modified fatigue life 31,182 hours

Miscellaneous Life Considerations

Other application factors usually considered separately from A₃, include high-speed centrifugal ball loading effects, varying operating conditions and installations of more than one bearing.

High-speed centrifugal ball effects. Fatigue life calculations discussed previously do not allow for centrifugal ball loading which starts to become significant at 750,000 dN. These effects require computerized analysis, which can be obtained by consulting Barden Product Engineering.

Varying operating conditions. If loads, speeds and modifying factors are not constant, bearing life can be determined by the following relationship:

$$L = \frac{1}{\frac{F_1}{L_1} + \frac{F_2}{L_2} + \frac{F_3}{L_3} + \frac{F_n}{L_n}}$$

in which

F_n = Fraction of the total life under conditions 1, 2, 3, etc.

$$(F_1 + F_2 + F_3 + F_n = 1.0).$$

L_n = The bearing life calculated for conditions 1, 2, 3, etc.

Bearing sets. When the life of tandem pairs (DT) or tandem triplex sets (DD) is being evaluated, the basic load rating should be taken as:

$$1.62 C \text{ for pairs}$$

$$2.16 C \text{ for triplex sets}$$

and the pair or triplex set treated as a single bearing. When determining Y values from Tables 34 and 35, the table should be entered with the following modifications for values of T/nd²:

$$0.50 T/nd^2 \text{ for pairs}$$

$$0.33 T/nd^2 \text{ for triplex sets}$$

again, the pair or set should be treated as a single bearing.

The life of bearings mounted as DB or DF pairs and subjected to thrust loads is dependent on the preload, the thrust load and the axial yield properties of the pair. Consult Barden Product Engineering for assistance with this type of application.

Engineering

Grease Life

In grease lubricated bearings life is often not determined by the internal design, fitting and specification of the bearing but by the grease itself. It is important for this reason to ensure appropriate running conditions to optimize useful grease life.

The life of the grease is dictated by the condition of the thickener. Acting as a sponge, the thickener will retain oil within its structure, gradually releasing the oil for use. As the thickener breaks down, the rate of oil release will increase until all useful oil is consumed. Degradation of the thickener depends on many things including the thickener type, operating loads/conditions and temperature.

At low speeds the mechanical churning of the grease is minimal, preserving the structure of the grease and its ability to retain oil. As speeds increase so to does the churning. Furthermore, at high speeds the motion of the balls - with respect to the raceways - can generate additional churning. If control of the bearings is not maintained throughout the operating spectrum of the unit this can lead to rapid degradation of the grease and subsequent bearing failure.

To ensure that the bearings are operating under controlled conditions, a suitable axial preload should be applied to the bearings. This prevents high ball excursions and differences in the operating contact angles between inner and outer races. For extreme high speed applications, centrifugal ball loading can be detrimental to life.

At the other extreme of operating conditions - that of temperature - grease life can also be affected dramatically. With increased temperature levels the viscosity of the base oil will drop, allowing a greater flow of oil from the thickener. Additionally the thickener selection is critical. If the thickener is not thermally stable it will be degraded at low speeds, accelerating oil loss. As a general rule of thumb, for each 10°C increase in the operating temperature of the bearing, a 50% reduction in useful grease life can be expected.

The use of ceramic balls in bearing applications has been shown to improve useful grease life. With a superior surface finish the balls will maintain EHD lubrication under the generation of a thinner oil film. During the regimes of boundary and mixed lubrication, wear levels between ball and race are greatly reduced due to the dissimilarity of the two materials. Generated wear particles contained in the grease can act as a catalyst for grease degradation as they themselves degrade. By limiting the amount of generated debris, this catalytic action can also be limited. This can also be reduced further by the use of Cronidur 30® for the race materials.

Fig. 20 . Grease life computation for normal temperatures.

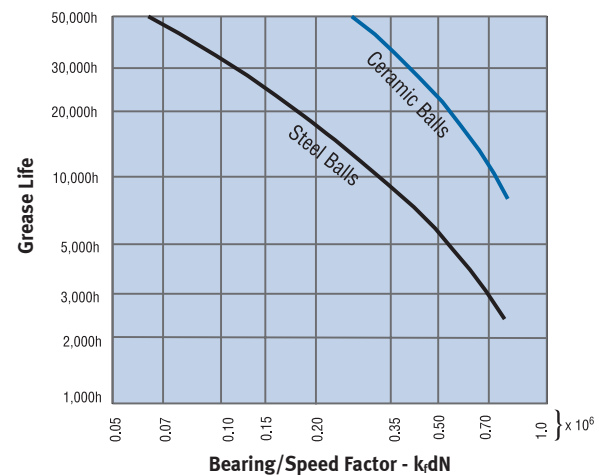

Values of K_f

Bearing Type	Radial Play	
	K3	K5
Deep Groove M&I	0.8	0.9
Deep Groove S&T	0.9	1.1
Angular Contact M&I	0.85	
Angular Contact S&T	0.88	

Use this information as a general guide only. Grease life is very dependent upon actual temperatures experienced within the bearing. Consequently, where performance is critical, the application should be reviewed with Barden Product Engineering.

Vibration

Performance of a bearing may be affected by vibration arising from exposure to external vibration or from self-generated frequencies.

Effect of Imposed Vibration

Bearings that are subject to external vibration along with other adverse conditions can fail or degrade in modes known as false brinelling, wear oxidation or corrosion fretting. Such problems arise when loaded bearings operate without sufficient lubrication at very low speeds, oscillating or even stationary. When vibration is added, surface oxidation and selective wear result from minute vibratory movement and limited rolling action in the ball-to-raceway contact areas. The condition can be relieved by properly designed isolation supports and adequate lubrication.

Vibration Sources

All bearings have nanometer variations of circular form in their balls and raceways. At operating speed, low level cyclic displacement can occur as a function of these variations, in combination with the speed of rotation and the internal bearing design. The magnitude of this cyclic displacement is usually less than the residual unbalance of the supported rotating member, and can be identified with vibration measuring equipment.

The presence of a pitched frequency in the bearings can excite a resonance in the supporting structure. The principal frequencies of ball bearing vibration can be identified from the bearing design and knowledge of variation-caused frequencies. Frequency analysis of the supporting structure is usually more difficult, but can be accomplished experimentally.

Monitoring vibration levels is an important tool in any preventive maintenance program. Vibration monitoring can detect abnormalities in components and indicate their replacement well before failure occurs. Knowledge of vibration levels helps reduce downtime and loss of production.

System Vibration Performance

The overall vibration performance of a mechanical system (shafts, bearings, housing, external loads) is complex and often unpredictable. A lightly damped resonance can put performance outside acceptable criteria at specific speed ranges. This interaction of system resonances and bearing events is most pronounced in less-than-ideal designs (long, slender shafts, over-hung rotor masses, etc.). These designs are relatively uncommon, and require a lot of engineering effort to resolve. They are usually solved through a series of iterations, via ball counts, radial and axial stiffness, and other parameters.

Engineering

Bearing Performance

Yield Stiffness

A ball bearing may be considered elastic in that when either radial, axial or moment loading is applied, it will yield in a predictable manner. Due to its inherent design, the yield rate of a bearing decreases as the applied load is increased.

As previously discussed under Preloading, the yield characteristics of bearings are employed in preloaded duplex pairs to provide essentially linear yield rates. Yield must also be considered in figuring loads for duplex pairs and the effects of interference fits on established preloads.

The deflection and resonance of bearing support systems are affected by bearing yield; questions or problems that arise in these areas should be referred to the Barden Product Engineering Department.

Torque

Starting torque, running torque and variations in torque levels can all be important to a bearing application. Starting torque — the moment required to start rotation — affects the power requirement of the system and may be crucial in applications such as gyro gimbals.

Running torque — the moment required to maintain rotation — is a factor in the system power loss during operation. Variations in running torque can cause errors in sensitive instrumentation applications.

To minimize bearing torque, it is important to consider internal bearing geometry and to have no contaminants present, minimal raceway and ball roundness variation, good finishes on rolling and sliding surfaces, and a lightweight, free-running cage.

The type and amount of lubricant must also be considered in determining bearing torque, but lubricant-related effects are often difficult to predict. This is particularly true as speeds increase, when an elastohydrodynamic film builds up between balls and races, decreasing the running torque significantly. Also influential are the viscosity/pressure coefficients of lubricants, which are affected by temperature.

Several aspects of bearing applications should be evaluated for their torque implications. For example, loading is relevant because torque generally increases in proportion to applied loads. Precision mounting surfaces, controlled fitting practices and careful axial adjustment should be employed to minimize torque.

Contact Barden Product Engineering Department for assistance in calculating actual torque values.

Measurement and Testing

Barden's ability to manufacture reliable high precision bearings results from a strong commitment to quality control. All facets of bearing manufacture and all bearing components are subjected to comprehensive tests using highly sophisticated instruments and techniques, some of which are our own design.

Examples of the types of test regularly performed by Barden include metallurgical testing of bar stock; torque and vibration analysis; roundness and waviness, surface finish and raceway curvature measurement; preload offset gauging; and lubricant chemistry evaluation.

Non-Destructive Testing

Non-destructive tests, i.e. those that evaluate without requiring that the test sample be damaged or destroyed, are among the most important that can be performed. Non-destructive tests can identify flaws and imperfections in bearing components that otherwise might not be detected.

Barden conducts many types of non-destructive tests, each designed to reveal potentially undesirable characteristics caused by manufacturing or material process flaws. Five of the most useful general purpose non-destructive tests are 1) liquid penetrant, 2) etch inspection, 3) magnetic particle, 4) eddy current, and 5) Barkhausen.

Functional Testing

Because functional testing of assembled bearings can be extremely important, Barden has developed several proprietary testing instruments for this purpose.

Bearing-generated vibration and noise is checked by using either the Barden Smoothrator®, the Bendix Anderometer®, the FAG functional tester or the Barden Quiet Bearing Analyzer. The function of these instruments is to detect any problems relating to surface finish and damage in the rolling contact area, contamination and geometry. They are used as quality control devices by Barden, to ensure that we deliver quiet, smooth-running bearings, and also as a trouble-shooting aid to trace the causes of bearing malfunction.

Bearing running torque is measured by various instruments such as the Barden Torkintegrator. Starting torque can also be measured on special gauges.

Non-repetitive runout of a bearing — a function of race lobing, ball diameter variation and cleanliness — is gauged on proprietary Barden instruments.

Detailed spectral analysis at the functional test level gives an overview on how well the manufacturing of the components and the assembly of these components was performed. In the rare instances where the spectrum indicates something went wrong, we can quickly disassemble a new bearing and inspect the raceways, cages and balls to see if assembly damage or contaminants are an issue. If this is not the case, we can look further into the manufacturing process using waviness measurement to see if poor geometry was induced in the grinding or honing process.

This sequential series of checks allows us to rapidly identify production issues and maintain a premium level of quality in our product.

Engineering

Bearing Application

Mounting & Fitting

After a bearing selection has been made, the product or system designer should pay careful attention to details of bearing mounting and fitting.

Bearing seats on shafts and housings must be accurately machined, and should match the bearing

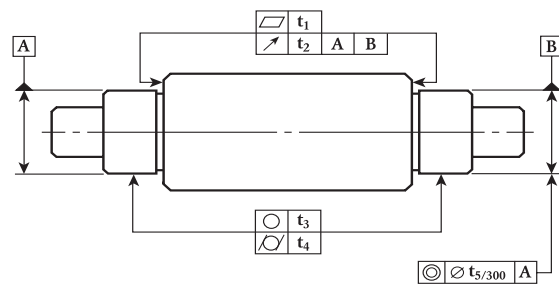

Table 38. Dimensional accuracy recommendations for shafts.

Characteristic	Outside Diameter of Shaft Bearing Seat, mm							
	<6	6-10	11-18	19-30	31-50	51-80	81-120	121-180
Flatness, t_1	30	60	80	100	100	120	150	200
Runout, t_2	40	100	120	150	150	200	250	300
Roundness, t_3	25	50	60	75	75	100	125	150
Taper, t_4	25	50	60	75	75	100	125	150
Concentricity, t_5	40	100	120	150	150	200	250	300

Values in microinches.

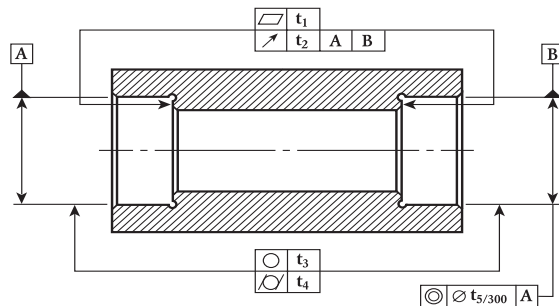

Table 39. Dimensional accuracy recommendations for housings.

Characteristic	Bore Diameter of Bearing Housing, mm							
	<10	10-18	19-30	31-50	51-80	81-120	121-180	181-250
Flatness, t_1	65	80	100	100	120	150	200	300
Runout, t_2	100	120	150	150	200	250	300	400
Roundness, t_3	60	75	100	125	150	150	200	250
Taper, t_4	50	60	75	75	100	125	150	200
Concentricity, t_5	100	120	150	150	200	250	300	400

Values in microinches.

ring width to provide maximum seating surface.

Recommendations for geometry and surface finish of bearing seats and shoulders are shown in Table 40. Dimensional accuracy recommendations for shafts and housings can be found in Tables 38 and 39.

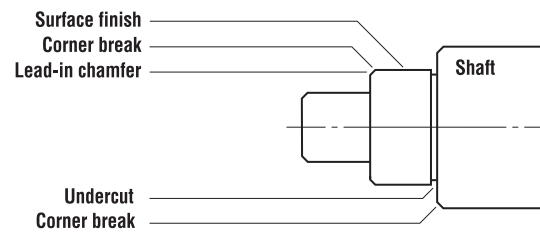

Table 40. Recommended finish of bearing seats and shoulders.

Detail or characteristic	Specification
Lead-in chamfer	Required
Undercut	Preferred
All corners	Burr-free at 5x magnification
Surface finish	16 microinch AA maximum
Bearing seats	Clean at 5x magnification

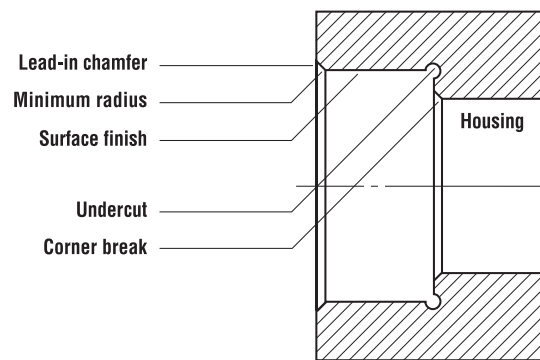

Table 41. Recommended geometry of corners

Detail	Nominal Bore Diameter, mm			
	<6	6-50	51-120	121-180
Corner break, min.	.001	.002	.003	.004
Minimum radius	.003	.003	.003	.004

Values in inches.

Shaft & Housing Fits

The ideal mounting for a precision bearing has a line-to-line fit, both on the shaft and in the housing. Such an idealized fit has no interference or looseness.

As a practical matter, many influencing factors have to be considered:

- OPERATING CONDITIONS SUCH AS LOAD, SPEED, TEMPERATURE.
- PROVISION FOR AXIAL EXPANSION.
- EASE OF ASSEMBLY AND DISASSEMBLY.
- REQUIREMENTS FOR RIGIDITY AND ROTATIONAL ACCURACY.
- MACHINING TOLERANCES.

Thus, the appropriate fit may have moderate interference, moderate looseness or even a transitional nature, as governed by operating requirements and the mounting design. Tables 42 and 43 provide general guidelines for typical applications, according to dominant requirements.

Fitting Practice

Interference fits (press fits) may be required when there is:

- A NEED TO AVOID MASS CENTER SHIFTS.
- HEAVY RADIAL LOADING.
- VIBRATION THAT COULD CAUSE FRETTING AND WEAR.
- A NEED FOR HEAT TRANSFER.
- A LACK OF AXIAL CLAMPING.
- TO COMPENSATE FOR CENTRIFUGAL GROWTH OF INNER RING.

Interference fits should be used cautiously, as they can distort the raceway and reduce radial play. In preloaded pairs, reduction of radial play increases the preload. If excessive, this can result in markedly reduced speed capability, higher operating temperature and premature failure.

Loose fits may be advisable when:

- THERE ARE AXIAL CLAMPING FORCES.
- EASE OF ASSEMBLY IS IMPORTANT.
- THERE MUST BE AXIAL MOVEMENT TO ACCOMMODATE SPRING LOADING OR THERMAL MOVEMENTS.

Table 42. Shaft and housing fits for miniature & instrument bearings.

	Dominant Requirements*	Fit Extremes, inches**		
		Random Fitting	Selective Fitting	
Shaft Fits	Inner ring clamped	Normal accuracy	.0000 -.0004	-.0001 -.0003
		Very low runout, high radial rigidity	+.0001 -.0003	.0000 -.0002
	Inner ring not clamped	Normal accuracy	+.0001 -.0003	.0000 -.0002
		Very low runout, high radial rigidity	+.0003 -.0001	+.0002 .0000
		Very high speed service	+.0002 -.0002	+.0001 -.0001
		Inner ring must float to allow for expansion	.0000 -.0004	-.0001 -.0003
Inner ring must hold fast to rotating shaft	+.0003 -.0001	+.0002 .0000		
Housing Fits	Normal accuracy, low to high speeds. Outer ring can move readily in housing for expansion.	.0000 -.0004	-.0001 -.0003	
		Very low runout, high radial rigidity. Outer ring need not move readily to allow for expansion.	+.0001 -.0003	.0000 -.0002
	Heavy radial load. Outer ring rotates.	+.0001 -.0003	.0000 -.0002	
		Outer ring must hold fast to rotating housing. Outer ring not clamped.	+.0004 .0000	+.0003 +.0001

*Radial loads are assumed to be stationary with respect to rotating ring.

**Interference fits are positive (+) and loose fits negative (-) for use in shaft and housing size determination, page 125.

Engineering

Bearing Application

Loose fits for stationary rings can be a problem if there is a dominant rotating radial load (usually unbalanced). While axial clamping, tighter fits and anti-rotation devices can help, a better solution is good dynamic balancing of rotating mass.

The appropriate fit may also vary, as governed by operating requirements and mounting design. To ensure a proper fit, assemble only clean, burr-free parts. Even small amounts of dirt on the shaft or housing can cause severe bearing misalignment problems.

When press fitting bearings onto a shaft, force should be applied evenly and only to the ring being fitted or internal damage to the bearing — such as

brinelling — could result. If mounting of bearings remains difficult, selective fitting practices should be considered. Selective fitting — utilizing a system of bearing calibration — allows better matching of bearing, shaft and housing tolerances, and can provide more control over assembly.

Fitting Notes:

1. Before establishing tight interference fits, consider their effect on radial internal clearance and bearing preloads (if present). Also realize that inaccuracies in shaft or housing geometry may be transferred to the bearings through interference fits.

2. Radial internal clearance is reduced by up to 80% of an interference fit. Thus, an interference of .005mm could cause an estimated .004mm decrease in internal clearance. Bearings with Code 3 radial play or less should have little or no interference fitting.
3. Keep in mind that mounting fits may be substantially altered at operating temperatures due to differential expansion of components. Excessive thermal expansion can quickly cause bearing failure if the radial play is reduced to zero or less, creating a radial preload.
4. An axially floating loose fit for one bearing of a two-bearing system is usually needed to avoid preloading caused by thermal expansion during operation.
5. When an interference fit is used, it is generally applied to the rotating ring. The stationary ring is fitted loose for ease of assembly.
6. Spring-loaded bearings require a loose fit to ensure that the spring loading remains operational.
7. In the case of loose fits, inner and outer rings should be clamped against shoulders to minimize the possibility of non-repetitive runout.
8. Diameter and squareness tolerances for shaft and housing mounting surfaces and shoulders should be similar to those for the bearing bore and O.D. The surface finish and hardness of mating components should be suitable for prolonged use, to avoid deterioration of fits during operation.
9. Proper press-fitting techniques must be used to prevent damage during assembly. Mounting forces must never be transmitted through the balls from one ring to the other. Thus, if the inner ring is being press fitted, force must be applied directly to the inner ring.
10. When a more precise fit is desired, bearings can be obtained that are calibrated into narrower bore and O.D. tolerance groups. These can be matched to similarly calibrated shafts and housings to cut the fit tolerance range by 50% or more.

11. Mounting bearings directly in soft non-ferrous alloy housings is considered poor practice unless loads are very light and temperatures are normal and steady — not subject to wide extremes. When temperatures vary drastically - as in aircraft applications, where aluminum is a common structural material - steel housing liners should be used to resist the effects of excessive thermal contraction or expansion upon bearing fits. Such liners should be carefully machined to the required size and tolerance while in place in the housing, to minimize the possibility of runout errors.

Other problems associated with non-ferrous alloys are galling during assembly and “pounding out” of bearing seats. Any questions that arise in unusual mounting situations should be discussed with the Barden Product Engineering Department.

12. For a more secure mounting of a bearing on a shaft or in a housing, clamping plates are considered superior to threaded nuts or collars. Plates are easily secured with separate screws.

When used with shafts and housings that are not shouldered, threaded nuts or collars can misalign bearings. Care must be taken to assure that threaded members are machined square to clamping surfaces. For high-speed precision applications, it may be necessary to custom scrape the contact faces of clamping nuts. In all cases, the clamping forces developed should not be capable of distorting the mating parts.

Shaft and Housing Size Determination

The fits listed in Tables 42 and 43 (pages 123 and 124) apply to normal operating temperatures and are based on average O.D. and bore sizes. The size and tolerance of the shaft or housing for a particular application can be readily computed by working back from the resulting fit, as shown in the example. Note that the total fit tolerance is always the sum of the bearing bore or O.D. tolerance plus the mating shaft or housing tolerance.

Table 43. Shaft and housing fits for spindle and turbine bearings.

	Dominant Requirements*		Fit Extremes, inches**			
			Nominal Bore Diameter, mm			
			7-30	31-80	81-180	
Shaft Fits	Inner ring clamped	Very low runout, high radial rigidity	+ .0002 - .0001	+ .0003 - .0001	+ .0004 - .0002	
		Low to high speeds, low to moderate radial loads	+ .00015 - .00015	+ .0002 - .0002	+ .0003 - .0003	
		Heavy radial load	Inner ring rotates	+ 0.003 .0003	+ .0004 .0000	+ .0006 .0000
			Outer ring rotates	.0000 - .0003	+ .0001 - .0003	+ .0001 - .0005
	Inner ring not clamped	Very low runout, high radial rigidity, light to moderate radial loads.	+ .0003 .0000	+ .0004 .0000	+ .0006 .0000	
		Heavy radial load	Inner ring rotates	+ .0004 + .0001	+ .0005 + .0001	+ .0007 + .0001
			Outer ring rotates	.0000 - .0003	+ .0001 - .0003	+ .0001 - .0005
		Inner ring must float to allow for expansion, low speed only.	.0000 - .0003	- .0001 - .0005	- .0008 - .0002	
			Nominal Outside Diameter, mm			
			18-80	81-120	121-250	
Housing Fits	Normal accuracy, low to high speeds, moderate temperature.		.0000 - .0004	+ .0001 - .0005	+ .0002 - .0006	
	Very low runout, high radial rigidity. Outer ring need not move readily to allow for expansion.		+ .0001 - .0003	+ .0002 - .0004	+ .0002 - .0006	
	High temperature, moderate to high speed. Outer ring can move readily to allow for expansion.		- .0001 - .0005	- .0001 - .0007	- .0002 - .0010	
	Heavy radial load, outer ring rotates.		+ .0004 .0000	+ .0006 .0000	+ .0008 .0000	

*Radial loads are assumed to be stationary with respect to rotating ring.

**Interference fits are positive (+) and loose fits negative (-) for use in shaft and housing size determination, page 125.

Engineering

Bearing Application

Example: Determination of shaft and housing size for a 204H bearing installation in a high speed cooling turbine.

	Bore	O.D.
204HJH nominal diameter	(.7874") 20mm	(1.8504") 47mm
204HJH tolerance from Table 32-33 (page 108-111)	+.000" -.0002"	+.000" -.00025"
Actual diameter range	.7874"/.7872" 1.8504"/1.85015"	

Desired fit chosen for this application

(data from Table 43, page 124)

On shaft: +.0002" (tight) / -.0001" (loose)

In housing: .0000" (line-to-line) / -.0004" (loose)

Determining shaft O.D.

Tightest fit is with maximum shaft O.D. and minimum bearing bore diameter:

Minimum bearing bore diameter.....	.7872"
Add: tightest fit extreme0002"
Maximum Shaft O.D.....	.7874"

Loosest fit is with minimum shaft O.D. and maximum bearing bore diameter:

Maximum bearing bore diameter7874"
Subtract: loosest fit extreme0001"
Minimum Shaft O.D.7873"

Determining housing I.D.

Tightest fit is with maximum bearing O.D. and minimum housing I.D.:

Maximum bearing O.D.....	1.8504"
Subtract: tightest fit extreme0000"
Minimum housing I.D.....	1.8504"

Loosest fit is with minimum bearing O.D. and maximum housing I.D.:

Minimum bearing O.D.....	1.85015"
Add: loosest fit extreme0004"
Maximum housing I.D.....	1.85055"

Maximum fillet radii

When a shaft or housing has integral shoulders for bearing retention, fillet radii of the shoulders must clear the corners of inner and outer rings to allow accurate seating of the bearing.

All product listings in the front of this catalogue and the shoulder diameter tables include values for maximum fillet radii. In the case of angular contact bearings, the smaller value r_i or r_o should be used when the cutaway side (non-thrust face) of the inner or outer ring is mounted against a solid shoulder.

Fig. 21 illustrates two methods of providing clearance for the bearing corner. In the upper view, fillet radius r is the maximum that the bearing will clear. The undercut fillet shown at bottom is preferred because it allows more accurate machining of the shoulder and seat, and permits more accurate bearing mounting.

Fig. 21. Two methods of providing clearance for bearing corner.

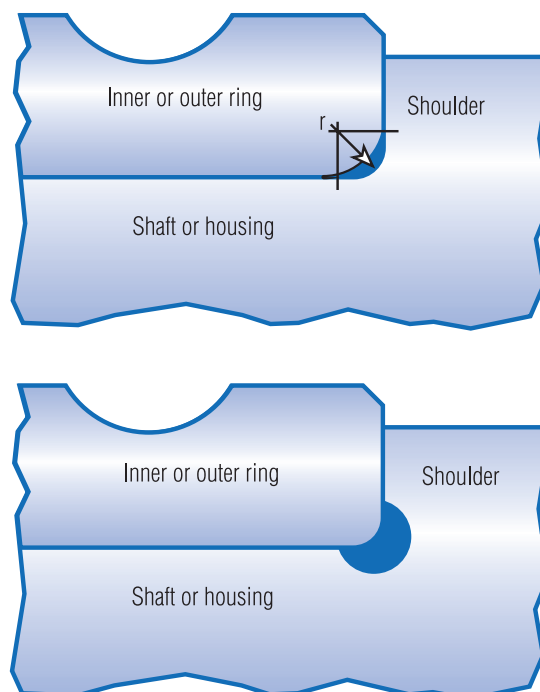

Shaft and Housing Shoulder Diameters

Shaft and housing shoulders must be high enough to provide accurate, solid seating with good alignment and support under maximum thrust loading. At the same time, the shoulders should not interfere with bearing cages, shields or seals. This caution is particularly important when bearings have high values of radial play and are subject to heavy thrust loads.

Besides being high enough for good seating, shoulders should be low enough to allow use of bearing tools against appropriate ring faces when bearings are dismounted, to avoid damage from forces transmitted through the balls. This caution applies especially to interference-fitted bearings that are going to be used again after dismounting.

Spacers, sleeves or other parts may be used to provide shoulders as long as recommended dimensional limits are observed. When possible, the rotating ring of a bearing should be located against an accurately machined surface on at least one face.

In high-speed applications where oil spray or mist lubrication systems are used, shoulder design may be extremely important because it is essential that lubricant flow be effective and unimpeded.

Deep Groove Instrument (inch) Abutments

Table 44. Shaft and housing shoulder diameter abutment dimensions for deep groove instrument (inch) bearings.

Bearing Number	Bearing Dimensions				Maximum Shaft/Housing Fillet Radius Which Bearing Corner Will Clear			Shaft Shoulder Diameters				Housing Shoulder Diameters			
	Bore Dia.	Outside Dia.	Relieved Face Diameter		r	r _i	r _o	Open		Shielded or Sealed		Open		Shielded or Sealed	
			O _i	O _o				h min.	h max.	h min.	h max.	H min.	H max.	H min.	H max.
SR0	0.0469	0.1562	-	-	0.003	-	-	0.071	0.077	0.071	0.077	0.122	0.132	0.128	0.132
SR1	0.0550	0.1875	-	-	0.003	-	-	0.079	0.093	0.079	0.093	0.149	0.164	0.155	0.164
SR1-4	0.0781	0.2500	-	-	0.003	-	-	0.102	0.156	0.102	0.156	0.211	0.226	0.217	0.226
SR133*	0.0937	0.1875	-	-	0.003	-	-	0.114	0.117	0.114	0.117	0.161	0.168	0.165	0.168
SR143	0.0937	0.2500	-	-	0.003	-	-	-	-	0.114	0.156	-	-	0.217	0.226
SR1-5	0.0937	0.3125	-	-	0.005	-	-	0.122	0.161	0.122	0.165	0.246	0.284	0.277	0.284
SR144*	0.1250	0.2500	-	-	0.003	-	-	0.148	0.156	0.148	0.156	0.211	0.226	0.217	0.226
SR144X3	0.1250	0.2500	-	-	0.003	-	-	-	-	0.148	0.156	-	-	0.217	0.226
SR2-5X2	0.1250	0.3125	-	-	0.003	-	-	-	-	0.153	0.165	-	-	0.277	0.284
SR154X1	0.1250	0.3125	-	-	0.003	-	-	-	-	0.148	0.156	-	-	0.217	0.284
SR2-5	0.1250	0.3125	-	-	0.003	-	-	0.153	0.176	0.153	0.165	0.261	0.284	0.277	0.284
SR2X52	0.1250	0.3750	-	-	0.006	-	-	-	-	0.153	0.198	-	-	0.304	0.325
SR2-6	0.1250	0.3750	-	-	0.005	-	-	0.179	0.200	0.153	0.200	0.300	0.325	0.326	0.347
SR164X3	0.1250	0.3750	-	-	0.003	-	-	-	-	0.148	0.156	-	-	0.217	0.347
SR2	0.1250	0.3750	-	-	0.012	-	-	0.179	0.200	0.179	0.200	0.300	0.325	0.320	0.325
SR174X5	0.1250	0.4100	-	-	0.003	-	-	-	-	0.148	0.156	-	-	0.227	0.341
SR174X2	0.1250	0.4250	-	-	0.003	-	-	-	-	0.179	0.198	-	-	0.304	0.375
SR184X2	0.1250	0.5000	-	-	0.003	-	-	-	-	0.148	0.156	-	-	0.217	0.446
SR2A	0.1250	0.5000	-	-	0.012	-	-	0.179	0.182	0.179	0.182	0.320	0.446	0.320	0.446
SR1204X1	0.1250	0.7500	-	-	0.005	-	-	-	-	0.225	0.235	-	-	0.343	0.650
SR155	0.1562	0.3125	-	-	0.003	-	-	0.180	0.222	0.180	0.222	0.280	0.288	0.286	0.288
SR156*	0.1875	0.3125	-	-	0.003	-	-	0.210	0.222	0.210	0.222	0.280	0.288	0.286	0.288
SR156X1	0.1875	0.3125	-	-	0.003	-	-	-	-	0.210	0.222	-	-	0.286	0.288
SR166*	0.1875	0.3750	-	-	0.003	-	-	0.216	0.235	0.216	0.235	0.325	0.347	0.341	0.347
SR186X3	0.1875	0.5000	-	-	0.003	-	-	-	-	0.216	0.235	-	-	0.341	0.446
SR186X2	0.1875	0.5000	-	-	0.005	-	-	-	-	0.216	0.235	-	-	0.341	0.446
SR3	0.1875	0.5000	-	-	0.012	-	-	0.244	0.276	0.244	0.252	0.412	0.446	0.430	0.446
SR3X8	0.1875	0.7500	-	-	0.012	-	-	0.244	0.252	0.244	0.252	0.430	0.446	0.430	0.678
SR3X23	0.1875	0.8750	-	-	0.012	-	-	-	-	0.244	0.252	-	-	0.430	0.799
SR168	0.2500	0.3750	-	-	0.003	-	-	0.272	0.284	0.272	0.284	0.343	0.352	0.349	0.352
SR188*	0.2500	0.5000	-	-	0.005	-	-	0.284	0.330	0.284	0.310	0.420	0.466	0.436	0.466
SR4	0.2500	0.6250	-	-	0.012	-	-	0.310	0.365	0.310	0.322	0.512	0.565	0.547	0.565
SR4A	0.2500	0.7500	-	-	0.016	-	-	0.322	0.365	0.322	0.342	0.596	0.678	0.646	0.678
SR4X35	0.2500	1.0480	-	-	0.012	-	-	-	-	0.310	0.322	-	-	0.547	0.980
SR1810	0.3125	0.5000	-	-	0.005	-	-	0.347	0.361	0.347	0.361	0.465	0.466	0.465	0.466
SR6	0.3750	0.8750	-	-	0.016	-	-	0.451	0.520	0.451	0.472	0.744	0.799	0.784	0.799
SR8	0.5000	1.1250	-	-	0.016	-	-	0.625	0.736	0.625	0.682	0.972	1.025	1.013	1.025
SR10	0.6250	1.3750	-	-	0.031	-	-	0.750	0.895	0.750	0.835	1.153	1.250	1.215	1.250

All dimensions in inches. *Applies also to extended ring versions.

When planned applications involve bearing removal and remounting, shoulder dimensions should be selected to facilitate dismounting. Minimum shaft shoulders and maximum housing shoulders are preferred, particularly with interference fits.

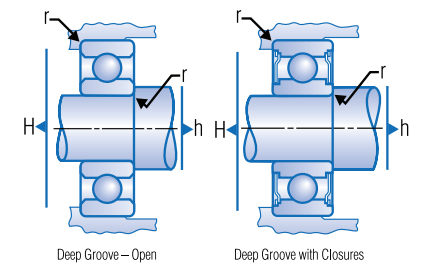

Deep Groove Instrument (metric) Abutments

Table 45. Shaft and housing shoulder diameter abutment dimensions for deep groove instrument (metric) bearings.

Bearing Number	Bearing Dimensions				Maximum Shaft/Housing Fillet Radius Which Bearing Corner Will Clear			Shaft Shoulder Diameters				Housing Shoulder Diameters			
	Bore Dia.	Outside Dia.	Relieved Face Diameter		r	r _i	r _o	Open		Shielded or Sealed		Open		Shielded or Sealed	
			O _i	O _o				h min.	h max.	h min.	h max.	H min.	H max.	H min.	H max.
S18M1-5	0.0591	0.1575	-	-	0.003	-	-	0.079	0.085	-	-	0.118	0.125	-	-
S19M1-5	0.0591	0.1969	-	-	0.006	-	-	0.114	0.117	0.114	0.117	0.161	0.168	0.165	0.168
S19M2	0.0787	0.2362	-	-	0.006	-	-	0.121	0.126	0.121	0.126	0.201	0.206	0.201	0.206
S18M2-5	0.0984	0.2362	-	-	0.006	-	-	0.134	0.139	-	-	0.196	0.206	-	-
S38M2-5	0.0984	0.2362	-	-	0.006	-	-	0.134	0.139	0.134	0.139	0.205	0.210	0.205	0.210
S19M2-5	0.0984	0.2756	-	-	0.006	-	-	0.148	0.156	0.148	0.156	0.220	0.225	0.220	0.226
S38M3	0.1181	0.2756	-	-	0.006	-	-	0.158	0.163	0.158	0.163	0.244	0.249	0.244	0.249
S2M3	0.1181	0.3937	-	-	0.006	-	-	0.179	0.200	0.179	0.200	0.320	0.325	0.320	0.325
S18M4	0.1575	0.3543	-	-	0.007	-	-	0.190	0.200	-	-	0.300	0.312	-	-
S38M4	0.1575	0.3543	-	-	0.006	-	-	0.179	0.200	0.179	0.200	0.320	0.325	0.320	0.325
S2M4	0.1575	0.5118	-	-	0.006	-	-	0.244	0.276	0.244	0.276	0.430	0.446	0.430	0.446
34	0.1575	0.6299	-	-	0.012	-	-	0.222	0.295	0.222	0.295	0.492	0.556	0.547	0.556
S19M5	0.1969	0.5118	-	-	0.006	-	-	0.284	0.330	0.284	0.310	0.420	0.466	0.436	0.466
34-5	0.1969	0.6299	-	-	0.012	-	-	0.222	0.295	0.222	0.256	0.492	0.556	0.547	0.556
35	0.1969	0.7480	-	-	0.012	-	-	0.261	0.383	0.261	0.342	0.596	0.674	0.646	0.674
36	0.2362	0.7480	-	-	0.012	-	-	0.300	0.383	0.300	0.342	0.596	0.674	0.646	0.674
S18M7Y2	0.2756	0.5512	-	-	0.006	-	-	0.337	0.357	-	-	0.470	0.490	-	-
37	0.2756	0.8661	-	-	0.012	-	-	0.341	0.463	0.340	0.415	0.692	0.792	0.744	0.792
37X2	0.2756	0.8661	-	-	0.012	-	-	-	-	0.340	0.415	-	-	0.744	0.792
38	0.3150	0.8661	-	-	0.012	-	-	0.379	0.463	0.379	0.415	0.692	0.792	0.744	0.792
38X2	0.3150	0.8661	-	-	0.012	-	-	-	-	0.379	0.415	-	-	0.744	0.792
38X6	0.3150	0.9449	-	-	0.012	-	-	-	-	0.379	0.415	-	-	0.744	0.870
39	0.3543	1.0236	-	-	0.016	-	-	0.450	0.583	0.450	0.547	0.837	0.924	0.893	0.924

All dimensions in inches.

Deep Groove Flanged (inch) Abutments

Table 46. Shaft and housing shoulder diameter abutment dimensions for deep groove flanged (inch) bearings.

Bearing Number	Bearing Dimensions				Maximum Shaft/Housing Fillet Radius Which Bearing Corner Will Clear			Shaft Shoulder Diameters				Housing Shoulder Diameters			
	Bore Dia.	Outside Dia.	Relieved Face Diameter		r	r _i	r _o	Open		Shielded or Sealed		Open		Shielded or Sealed	
			O _i	O _o				h min.	h max.	h min.	h max.	H min.	H max.	H min.	H max.
SFR0	0.0469	0.1560	-	-	0.003	-	-	0.071	0.077	0.071	0.077	0.122	0.132	0.128	0.132
SFR1	0.0550	0.1875	-	-	0.003	-	-	0.079	0.093	0.079	0.093	0.149	0.164	0.155	0.164
SFR1-4	0.0781	0.2500	-	-	0.003	-	-	0.102	0.156	0.102	0.156	0.211	0.226	0.217	0.226
SFR133*	0.0937	0.1875	-	-	0.003	-	-	0.114	0.117	0.114	0.117	0.161	0.168	0.165	0.168
SFR1-5	0.0937	0.3125	-	-	0.003	-	-	0.122	0.161	0.122	0.165	0.246	0.284	0.277	0.284
SFR144*	0.1250	0.2500	-	-	0.003	-	-	0.148	0.156	0.148	0.156	0.211	0.226	0.217	0.226
SFR2-5	0.1250	0.3125	-	-	0.003	-	-	0.153	0.175	0.153	0.165	0.261	0.284	0.277	0.284
SFR2-6	0.1250	0.3750	-	-	0.005	-	-	0.153	0.200	0.153	0.200	0.300	0.325	0.326	0.347
SFR2	0.1250	0.3750	-	-	0.012	-	-	0.179	0.200	0.179	0.200	0.300	0.325	0.320	0.325
SFR155	0.1562	0.3125	-	-	0.003	-	-	0.180	0.222	0.180	0.222	0.280	0.288	0.286	0.288
SFR156*	0.1875	0.3125	-	-	0.003	-	-	0.210	0.222	0.210	0.222	0.280	0.288	0.286	0.288
SFR166*	0.1875	0.3750	-	-	0.003	-	-	0.216	0.235	0.216	0.235	0.325	0.347	0.341	0.347
SFR3X3	0.1875	0.5000	-	-	0.012	-	-	0.244	0.276	-	-	0.412	0.446	-	-
SFR3	0.1875	0.5000	-	-	0.012	-	-	0.244	0.276	0.244	0.252	0.412	0.446	0.430	0.446
SFR168	0.2500	0.3750	-	-	0.003	-	-	0.272	0.284	0.272	0.284	0.343	0.352	0.349	0.352
SFR188*	0.2500	0.5000	-	-	0.005	-	-	0.284	0.330	0.284	0.310	0.420	0.466	0.436	0.466
SFR4	0.2500	0.6250	-	-	0.012	-	-	0.310	0.365	0.310	0.322	0.512	0.565	0.547	0.565
SFR1810	0.3125	0.5000	-	-	0.005	-	-	0.347	0.361	0.347	0.361	0.465	0.466	0.465	0.466
SFR6	0.3750	0.8750	-	-	0.016	-	-	0.451	0.520	0.451	0.472	0.744	0.799	0.784	0.799

All dimensions in inches. *Applies also to extended ring versions.

When planned applications involve bearing removal and remounting, shoulder dimensions should be selected to facilitate dismounting. Minimum shaft shoulders and maximum housing shoulders are preferred, particularly with interference fits.

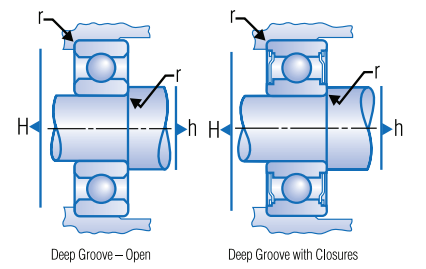

Deep Groove Thin Section (inch) 500 and 1000 Series Abutments

Table 47. Shaft and housing shoulder diameter abutment dimensions for deep groove thin section 500 series (inch) bearings.

Bearing Number	Bearing Dimensions				Maximum Shaft/Housing Fillet Radius Which Bearing Corner Will Clear			Shaft Shoulder Diameters				Housing Shoulder Diameters			
	Bore Dia.	Outside Dia.	Relieved Face Diameter		r	r _i	r _o	Open		Shielded or Sealed		Open		Shielded or Sealed	
			O _i	O _o				h min.	h max.	h min.	h max.	H min.	H max.	H min.	H max.
SN538	0.6250	1.0625	-	-	0.015	-	-	0.725	0.773	0.725	0.773	0.952	0.962	0.952	0.962
A538	0.6250	1.0625	-	-	0.015	-	-	0.725	0.773	0.725	0.773	0.952	0.962	0.952	0.962
SN539	0.7500	1.1875	-	-	0.015	-	-	0.850	0.894	0.850	0.894	1.078	1.088	1.078	1.088
A539	0.7500	1.1875	-	-	0.015	-	-	0.850	0.894	0.850	0.894	1.078	1.088	1.078	1.088
SN540	0.8750	1.3125	-	-	0.015	-	-	0.975	1.019	0.975	1.019	1.202	1.212	1.202	1.212
A540	0.8750	1.3125	-	-	0.015	-	-	0.975	1.019	0.975	1.019	1.202	1.212	1.202	1.212
SN541	1.0625	1.5000	-	-	0.015	-	-	1.163	1.210	1.163	1.210	1.390	1.400	1.390	1.400
A541	1.0625	1.5000	-	-	0.015	-	-	1.163	1.210	1.163	1.210	1.390	1.400	1.390	1.400
SN542	1.3125	1.7500	-	-	0.015	-	-	1.413	1.460	1.413	1.460	1.640	1.650	1.640	1.650
A542	1.3125	1.7500	-	-	0.015	-	-	1.413	1.460	1.413	1.460	1.640	1.650	1.640	1.650
SN543	1.5625	2.0000	-	-	0.015	-	-	1.663	1.706	1.663	1.706	1.890	1.900	1.890	1.900
A543	1.5625	2.0000	-	-	0.015	-	-	1.663	1.706	1.663	1.706	1.890	1.900	1.890	1.900

All dimensions in inches.

Table 48. Shaft and housing shoulder diameter abutment dimensions for deep groove thin section 1000 series (inch) bearings.

Bearing Number	Bearing Dimensions				Maximum Shaft/Housing Fillet Radius Which Bearing Corner Will Clear			Shaft Shoulder Diameters				Housing Shoulder Diameters			
	Bore Dia.	Outside Dia.	Relieved Face Diameter		r	r _i	r _o	Open		Shielded or Sealed		Open		Shielded or Sealed	
			O _i	O _o				h min.	h max.	h min.	h max.	H min.	H max.	H min.	H max.
SR1012	0.3750	0.6250	-	-	0.010	-	-	0.435	0.450	0.435	0.450	0.560	0.565	0.560	0.565
SWR1012	0.3750	0.6250	-	-	0.010	-	-	0.435	0.450	0.405	0.422	0.560	0.565	0.560	0.565
SR1216	0.5000	0.7500	-	-	0.010	-	-	0.560	0.575	0.560	0.575	0.685	0.690	0.685	0.690
SR1420	0.6250	0.8750	-	-	0.010	-	-	0.687	0.700	0.687	0.700	0.811	0.816	0.811	0.816
SR1624	0.7500	1.0000	-	-	0.010	-	-	0.812	0.825	0.812	0.825	0.936	0.941	0.936	0.941

All dimensions in inches.

When planned applications involve bearing removal and remounting, shoulder dimensions should be selected to facilitate dismounting. Minimum shaft shoulders and maximum housing shoulders are preferred, particularly with interference fits.

Deep Groove Spindle & Turbine (metric) Abutments

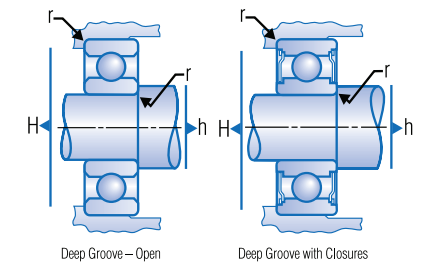

Table 49. Shaft and housing shoulder diameter abutment dimensions for deep groove spindle & turbine (metric) bearings.

Bearing Number	Bearing Dimensions				Maximum Shaft/Housing Fillet Radius Which Bearing Corner Will Clear			Shaft Shoulder Dimeters				Housing Shoulder Diameters			
	Bore Dia.	Outside Dia.	Relieved Face Diameter		r	r _i	r _o	Open		Shielded or Sealed		Open		Shielded or Sealed	
			O _i	O _o				h min.	h max.	h min.	h max.	H min.	H max.	H min.	H max.
100	0.3937	1.0236	-	-	0.012	-	-	0.465	0.547	0.465	0.547	0.893	0.953	0.893	0.953
100X1	0.3937	1.0236	-	-	0.012	-	-	0.465	0.547	0.465	0.547	0.893	0.953	0.893	0.953
200	0.3937	1.1811	-	-	0.025	-	-	0.518	0.656	0.518	0.596	0.953	1.057	1.014	1.057
200X1	0.3937	1.1811	-	-	0.025	-	-	0.518	0.656	0.518	0.596	0.953	1.057	1.014	1.057
101	0.4724	1.1024	-	-	0.012	-	-	0.543	0.670	0.543	0.630	0.924	1.031	0.980	1.031
101X1	0.4724	1.1024	-	-	0.012	-	-	0.543	0.670	0.543	0.630	0.924	1.031	0.980	1.031
201	0.4724	1.2598	-	-	0.025	-	-	0.602	0.675	0.602	0.675	1.100	1.130	1.100	1.130
201X1	0.5118	1.2598	-	-	0.025	-	-	0.602	0.675	0.642	0.675	1.100	1.130	1.100	1.130
9201	0.5118	1.2598	-	-	0.025	-	-	0.602	0.675	0.642	0.675	1.100	1.130	1.100	1.130
1902X1	0.5906	1.1024	-	-	0.012	-	-	0.602	0.675	0.662	0.720	1.100	1.130	0.989	1.038
102	0.5906	1.2598	-	-	0.012	-	-	0.662	0.798	0.662	0.772	1.053	1.189	1.101	1.189
102X1	0.5906	1.2598	-	-	0.012	-	-	0.662	0.798	0.662	0.772	1.053	1.189	1.101	1.189
202	0.5906	1.3780	-	-	0.025	-	-	0.726	0.755	0.726	0.755	1.223	1.243	1.223	1.243
202X1	0.5906	1.3780	-	-	0.025	-	-	0.726	0.755	0.726	0.755	1.223	1.243	1.223	1.243
9302X1	0.5906	1.6535	-	-	0.040	-	-	0.726	0.755	0.751	0.890	1.223	1.243	1.410	1.493
103	0.6693	1.3780	-	-	0.012	-	-	0.740	0.835	0.740	0.835	1.215	1.307	1.215	1.307
203	0.6693	1.5748	-	-	0.025	-	-	0.810	0.952	0.810	0.890	1.292	1.433	1.372	1.433
9203	0.6693	1.5748	-	-	0.025	-	-	0.810	0.952	0.810	0.890	1.292	1.433	1.372	1.433
104	0.7874	1.6535	-	-	0.025	-	-	0.898	1.050	0.898	0.981	1.390	1.543	1.458	1.543
204	0.7874	1.8504	-	-	0.040	-	-	0.977	1.060	0.977	1.060	1.610	1.661	1.610	1.661
9204	0.7874	1.8504	-	-	0.040	-	-	0.977	1.060	0.977	1.060	1.610	1.661	1.610	1.661
105	0.9843	1.8504	-	-	0.025	-	-	1.095	1.291	1.095	1.176	1.554	1.740	1.655	1.740
205	0.9843	2.0472	-	-	0.040	-	-	1.174	1.320	1.174	1.245	1.720	1.858	1.610	1.661
9205	0.9843	2.0472	-	-	0.040	-	-	1.174	1.320	1.174	1.245	1.720	1.858	1.610	1.661
305	0.9843	2.4409	-	-	0.040	-	-	1.224	1.425	1.224	1.425	2.094	2.200	2.094	2.200
9305	0.9843	2.4409	-	-	0.040	-	-	1.224	1.425	1.224	1.425	2.094	2.200	2.094	2.200
106	1.1811	2.1654	-	-	0.040	-	-	1.331	1.451	1.331	1.451	1.949	2.015	1.949	2.015
206	1.1811	2.4409	-	-	0.040	-	-	1.392	1.500	1.392	1.500	2.200	2.230	2.200	2.230
9206	1.1811	2.4409	-	-	0.040	-	-	1.392	1.500	1.392	1.500	2.200	2.230	2.200	2.230
306	1.1811	2.8346	-	-	0.040	-	-	1.460	1.693	1.460	1.693	2.410	2.550	2.410	2.550
9306	1.1811	2.8346	-	-	0.040	-	-	1.460	1.693	1.460	1.693	2.410	2.550	2.410	2.550
107	1.3780	2.4409	-	-	0.040	-	-	1.536	1.620	1.536	1.620	2.190	2.283	2.190	2.283
207	1.3780	2.8346	-	-	0.040	-	-	1.611	1.777	1.611	1.777	2.523	2.601	2.523	2.601
9207	1.3780	2.8346	-	-	0.040	-	-	1.611	1.777	1.611	1.777	2.523	2.601	2.523	2.601
307	1.3780	3.1496	-	-	0.060	-	-	1.738	1.905	1.738	1.905	2.720	2.800	2.720	2.800
9307	1.3780	3.1496	-	-	0.060	-	-	1.738	1.905	1.738	1.905	2.720	2.800	2.720	2.800
108	1.5748	2.6772	-	-	0.040	-	-	1.749	1.848	1.749	1.848	2.315	2.503	2.315	2.503
208	1.5748	3.1496	-	-	0.040	-	-	1.819	2.130	1.819	2.050	2.643	2.906	2.788	2.906
9208	1.5748	3.1496	-	-	0.040	-	-	1.819	2.130	1.819	2.050	2.643	2.906	2.788	2.906
308	1.5748	3.5433	-	-	0.060	-	-	1.935	2.200	1.935	2.200	3.080	3.185	3.080	3.185
9308	1.5748	3.5433	-	-	0.060	-	-	1.935	2.200	1.935	2.200	3.080	3.185	3.080	3.185
109	1.7717	2.9528	-	-	0.040	-	-	1.945	2.174	1.945	2.174	2.714	2.779	2.714	2.779

All dimensions in inches.

When planned applications involve bearing removal and remounting, shoulder dimensions should be selected to facilitate dismounting. Minimum shaft shoulders and maximum housing shoulders are preferred, particularly with interference fits.

Table 49. Continued.

Bearing Number	Bearing Dimensions				Maximum Shaft/Housing Fillet Radius Which Bearing Corner Will Clear			Shaft Shoulder Dimeters				Housing Shoulder Diameters			
	Bore Dia.	Outside Dia.	Relieved Face Diameter		r	r _i	r _o	Open		Shielded or Sealed		Open		Shielded or Sealed	
			O _i	O _o				h min.	h max.	h min.	h max.	H min.	H max.	H min.	H max.
209	1.7717	3.3465	-	-	0.040	-	-	2.016	2.289	2.016	2.289	2.850	3.102	2.995	3.102
9209	1.7717	3.3465	-	-	0.040	-	-	2.016	2.289	2.016	2.289	2.850	3.102	2.995	3.102
309	1.7117	3.9370	-	-	0.080	-	-	2.252	2.510	2.252	2.510	3.232	3.580	3.232	3.580
9309	1.7117	3.9370	-	-	0.080	-	-	2.252	2.510	2.252	2.510	3.232	3.580	3.232	3.580
110	1.9685	3.1496	-	-	0.040	-	-	2.142	2.238	2.142	2.238	2.908	2.976	2.908	2.976
210	1.9685	3.5433	-	-	0.040	-	-	2.224	2.460	2.224	2.460	3.060	3.288	3.060	3.288
310	1.9685	4.3307	-	-	0.080	-	-	2.589	2.700	2.589	2.700	3.600	3.712	3.600	3.712
9310	1.9685	4.3307	-	-	0.080	-	-	2.589	2.700	2.589	2.700	3.600	3.712	3.600	3.712
111	2.1654	3.5433	-	-	0.040	-	-	2.355	2.524	2.355	2.524	3.113	3.354	3.113	3.354
211	2.1654	3.9370	-	-	0.060	-	-	2.482	2.764	2.482	2.764	3.362	3.620	3.362	3.620
311	2.1654	4.7244	-	-	0.080	-	-	2.645	3.044	2.645	3.044	3.897	4.244	3.897	4.244
312	2.3622	5.1181	-	-	0.080	-	-	2.842	3.155	2.842	3.155	4.222	4.638	4.222	4.638
9312	2.3622	5.1181	-	-	0.080	-	-	2.842	3.155	2.842	3.155	4.222	4.638	4.222	4.638
313, 313SS	2.5591	5.5118	-	-	0.080	-	-	2.880	3.374	2.880	3.450	4.771	5.192	4.885	5.192
9313	2.5591	5.5118	-	-	0.080	-	-	2.880	3.374	2.880	3.450	4.885	5.192	4.885	5.192
314	2.7559	5.9055	-	-	0.080	-	-	3.076	3.750	3.076	3.750	5.215	5.556	5.215	5.556
9314	2.7559	5.9055	-	-	0.080	-	-	3.076	3.750	3.076	3.750	5.215	5.556	5.215	5.556
315	2.9528	6.2992	-	-	0.080	-	-	3.273	3.914	3.273	3.914	5.478	5.979	5.478	5.979
316	3.1496	6.6924	-	-	0.080	-	-	3.630	4.390	3.630	4.390	5.505	6.213	5.505	6.213
317	3.3465	7.0866	-	-	0.100	-	-	3.947	4.654	3.947	4.654	5.836	6.487	5.836	6.487
318	3.5433	7.4803	-	-	0.100	-	-	4.193	4.918	4.193	4.918	6.165	6.880	6.165	6.880
320	3.9370	8.4646	-	-	0.120	-	-	4.420	5.430	4.420	5.430	7.438	7.980	7.438	7.980
222	4.3307	7.8740	-	-	0.080	-	-	4.970	5.539	4.970	5.539	6.722	7.234	6.722	7.234
322	4.3307	9.4488	-	-	0.120	-	-	5.131	6.150	5.131	6.150	7.725	8.649	7.725	8.649
232	6.2992	11.4173	-	-	0.120	-	-	7.090	8.172	7.090	8.172	9.616	10.610	9.616	10.610

All dimensions in inches.

Angular Contact (metric) Abutments

Table 50. Shaft and housing shoulder diameter abutment dimensions for angular contact (metric) bearings.

Bearing Number	Bearing Dimensions				Maximum Shaft/Housing Fillet Radius Which Bearing Corner Will Clear			Shaft Shoulder Dimeters				Housing Shoulder Diameters			
	Bore Dia.	Outside Dia.	Relieved Face Diameter		r	r _i	r _o	Open		Shielded or Sealed		Open		Shielded or Sealed	
			O _i	O _o				h min.	h max.	h min.	h max.	H min.	H max.	H min.	H max.
2M3BY3	0.1181	0.3937	0.1694	-	0.005	0.005	-	0.170	0.200	-	-	0.292	0.321	-	-
34H	0.1575	0.6299	-	0.522	0.012	-	0.010	0.222	0.295	-	-	0.492	0.556	-	-
34BX4	0.1575	0.6299	0.234	-	0.012	0.005	-	0.222	0.300	-	-	0.492	0.556	-	-
34-5H	0.1969	0.6299	-	0.522	0.012	-	-	0.222	0.295	-	-	0.492	0.556	-	-
19M5BY1	0.1969	0.5120	0.294	-	0.005	0.005	-	0.300	0.323	-	-	0.412	0.450	-	-
36H	0.2362	0.7480	-	0.636	0.012	-	0.010	0.300	0.383	-	-	0.596	0.674	-	-
36BX1	0.2362	0.7480	0.310	-	0.012	0.005	-	0.300	0.383	-	-	0.596	0.674	-	-
37H	0.2756	0.8661	-	0.739	0.012	-	0.010	0.340	0.463	-	-	0.692	0.792	-	-
38H	0.3150	0.8661	-	0.739	0.012	-	0.010	0.379	0.463	-	-	0.692	0.792	-	-
38BX2	0.3150	0.8661	0.413	-	0.012	0.005	-	0.379	0.463	-	-	0.692	0.792	-	-
39H	0.3543	1.0236	-	0.898	0.012	-	0.010	0.450	0.583	-	-	0.837	0.924	-	-
100H	0.3937	1.0236	-	0.898	0.012	-	0.010	0.465	0.583	-	-	0.837	0.953	-	-
200H	0.3937	1.1811	-	1.024	0.025	-	0.015	0.518	0.656	-	-	0.953	1.057	-	-
1901H	0.4724	0.9449	-	0.870	0.012	-	0.006	0.570	0.630	-	-	0.795	0.850	-	-
101H	0.4724	1.1024	-	0.985	0.012	-	0.010	0.543	0.670	-	-	0.924	1.031	-	-
101BX48	0.4724	1.1024	0.599	-	0.012	0.010	-	0.543	0.670	-	-	0.924	1.031	-	-
201H	0.4724	1.2598	-	1.118	0.025	-	0.015	0.602	0.721	-	-	1.040	1.130	-	-
301H	0.4724	1.4567	-	1.235	0.040	-	0.020	0.712	0.832	-	-	1.111	1.220	-	-
1902H	0.5906	1.1024	-	1.022	0.012	-	0.006	0.708	0.785	-	-	0.951	1.006	-	-
102H	0.5906	1.2598	-	1.112	0.012	-	0.010	0.662	0.798	-	-	1.053	1.189	-	-
102BX48	0.5906	1.2598	0.725	-	0.012	0.010	-	0.662	0.798	-	-	1.053	1.189	-	-
102BJX6	0.5906	1.2598	0.725	-	0.012	0.010	-	0.662	0.798	-	-	1.053	1.189	-	-
202H	0.5906	1.3780	-	1.235	0.025	-	0.015	0.726	0.815	-	-	1.153	1.243	-	-
302H	0.5906	1.6535	-	1.481	0.040	-	0.020	0.830	0.963	-	-	1.324	1.413	-	-
103H	0.6693	1.3780	-	1.213	0.012	-	0.010	0.740	0.835	-	-	1.153	1.307	-	-
103BX48	0.6693	1.3780	0.786	-	0.012	0.010	-	0.740	0.930	-	-	1.153	1.307	-	-
203H	0.6693	1.5748	-	1.388	0.025	-	0.015	0.810	0.986	-	-	1.267	1.433	-	-
303H	0.6693	1.8504	-	1.610	0.040	-	0.020	0.900	1.000	-	-	1.450	1.610	-	-
104H	0.7874	1.6535	-	1.470	0.025	-	0.015	0.898	1.050	-	-	1.390	1.543	-	-
104BX48	0.7874	1.6535	0.922	-	0.025	0.015	-	0.898	1.093	-	-	1.390	1.543	-	-
204H	0.7874	1.8504	-	1.645	0.040	-	0.020	0.977	1.130	-	-	1.530	1.661	-	-
304H	0.7874	2.0472	-	1.837	0.040	-	0.020	1.013	1.216	-	-	1.665	1.780	-	-
1905H	0.9843	1.6535	-	1.538	0.012	-	0.010	1.092	1.210	-	-	1.439	1.539	-	-
105H	0.9843	1.8504	-	1.668	0.025	-	0.015	1.095	1.291	-	-	1.587	1.740	-	-
105BX48	0.9843	1.8504	1.119	-	0.025	0.015	-	1.095	1.291	-	-	1.554	1.740	-	-
205H	0.9843	2.0472	-	1.835	0.040	-	0.020	1.174	1.320	-	-	1.720	1.858	-	-
305H	0.9843	2.4409	-	2.192	0.040	-	0.020	1.230	1.476	-	-	1.968	2.180	-	-
106H	1.1811	2.1654	-	1.972	0.040	-	0.020	1.331	1.511	-	-	1.869	2.015	-	-
106BX48	1.1811	2.1654	1.367	-	0.040	0.020	-	1.331	1.511	-	-	1.869	2.015	-	-
206H	1.1811	2.4409	-	2.228	0.040	-	0.020	1.392	1.616	-	-	2.044	2.230	-	-
306H	1.1811	2.8346	-	2.552	0.040	-	0.020	1.460	1.742	-	-	2.300	2.550	-	-
1907H	1.378	2.1654	-	2.041	0.025	-	0.015	1.540	1.655	-	-	1.928	2.050	-	-
107H	1.378	2.4409	-	2.225	0.040	-	0.020	1.536	1.753	-	-	2.081	2.283	-	-

All dimensions in millimetres.

When planned applications involve bearing removal and remounting, shoulder dimensions should be selected to facilitate dismounting. Minimum shaft shoulders and maximum housing shoulders are preferred, particularly with interference fits.

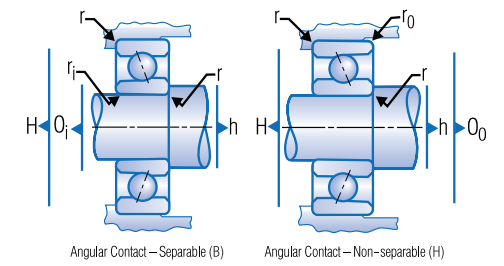
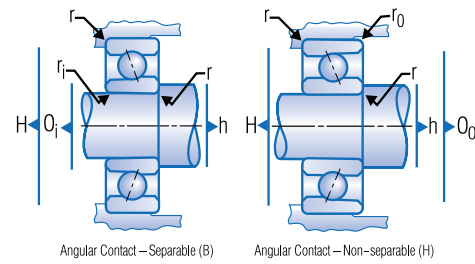

Table 50. Continued.

Bearing Number	Bearing Dimensions				Maximum Shaft/Housing Fillet Radius Which Bearing Corner Will Clear			Shaft Shoulder Dimeters				Housing Shoulder Diameters			
	Bore Dia.	Outside Dia.	Relieved Face Diameter		r	r _i	r _o	Open		Shielded or Sealed		Open		Shielded or Sealed	
			O _i	O _o				h min.	h max.	h min.	h max.	H min.	H max.	H min.	H max.
107BX48	1.3780	2.4409	1.542	-	0.040	0.020	-	1.615	1.710	-	-	2.190	2.283	-	-
207H	1.3780	2.8346	-	2.562	0.040	-	0.020	1.611	1.857	-	-	2.382	2.601	-	-
307H	1.3780	3.1496	-	2.842	0.060	-	0.030	1.738	1.983	-	-	2.573	2.800	-	-
108H	1.5748	2.6772	-	2.442	0.040	-	0.020	1.749	1.939	-	-	2.315	2.503	-	-
108BX48	1.5748	2.6772	1.755	-	0.040	0.020	-	1.835	1.970	-	-	2.298	2.503	-	-
208H	1.5748	3.1496	-	2.834	0.040	-	0.020	1.819	2.130	-	-	2.620	2.906	-	-
308H	1.5748	3.5433	-	3.220	0.060	-	0.030	1.935	2.280	-	-	2.937	3.185	-	-
109H	1.7717	2.9528	-	2.739	0.040	-	0.020	1.945	2.174	-	-	2.569	2.779	-	-
209H	1.7717	3.3465	-	3.042	0.040	-	0.020	2.016	2.289	-	-	2.850	3.102	-	-
309H	1.7717	3.9370	-	3.545	0.060	-	0.030	2.130	2.510	-	-	3.232	3.580	-	-
110H	1.9685	3.1496	-	2.937	0.040	-	0.020	2.142	2.372	-	-	2.768	2.976	-	-
110BX48	1.9685	3.1496	2.142	-	0.040	0.020	-	2.183	2.372	-	-	2.768	2.937	-	-
210H	1.9685	3.5433	-	3.263	0.040	-	0.020	2.224	2.460	-	-	3.060	3.288	-	-
310H	1.9685	4.3307	-	3.902	0.080	-	0.040	2.589	2.700	-	-	3.502	3.851	-	-
211H	2.1654	3.9370	-	3.612	0.060	-	0.030	2.482	2.764	-	-	3.362	3.620	-	-
212H	2.3622	4.3307	-	3.978	0.060	-	0.030	2.701	2.975	-	-	3.725	3.993	-	-
312H	2.3622	5.1181	-	4.160	0.080	-	0.040	2.682	3.172	-	-	4.402	4.798	-	-
113H	2.5591	3.9370	-	3.688	0.040	-	0.020	2.748	3.003	-	-	3.513	3.748	-	-
113BX48	2.5591	3.9370	2.759	-	0.040	0.020	-	2.811	3.003	-	-	3.513	3.688	-	-
214H	2.7559	4.9213	-	4.531	0.060	-	0.030	3.117	3.495	-	-	4.220	4.561	-	-
115H	2.9528	4.5276	-	4.243	0.040	-	0.020	3.158	3.490	-	-	4.015	4.323	-	-
117H	3.3465	5.1181	-	4.797	0.040	-	0.020	3.567	3.950	-	-	4.542	4.897	-	-
117BX48	3.3465	5.1181	3.625	-	0.040	0.020	-	3.668	3.950	-	-	4.542	4.795	-	-
118H	3.5433	5.5118	-	5.156	0.060	-	0.030	3.820	4.217	-	-	4.874	5.236	-	-
220H	3.9370	7.0866	-	6.514	0.080	-	0.040	4.447	5.012	-	-	6.062	6.576	-	-

All dimensions in inches.



Angular Contact (inch) Abutments

Table 51 . Shaft and housing shoulder diameter abutment dimensions for angular contact (inch) bearings.

Bearing Number	Bearing Dimensions				Maximum Shaft/Housing Fillet Radius Which Bearing Corner Will Clear			Shaft Shoulder Dimeters				Housing Shoulder Diameters			
	Bore Dia.	Outside Dia.	Relieved Face Diameter		r	r _i	r _o	Open		Shielded or Sealed		Open		Shielded or Sealed	
			O _i	O _o				h min.	h max.	h min.	h max.	H min.	H max.	H min.	H max.
R1-5B	0.0937	0.3125	0.139	-	0.003	0.003	-	0.122	0.156	-	-	0.246	0.284	-	-
R1-5H	0.0937	0.3125	-	0.263	0.003	-	0.003	0.122	0.161	-	-	0.246	0.284	-	-
R144H	0.1250	0.2500	-	0.225	0.003	-	0.003	0.148	0.156	-	-	0.211	0.226	-	-
R2-5B	0.1250	0.3125	0.154	-	0.003	0.003	-	0.153	0.176	-	-	0.261	0.284	-	-
R2-5H	0.1250	0.3125	-	0.284	0.003	-	0.003	0.153	0.176	-	-	0.261	0.284	-	-
R2B	0.1250	0.3750	0.184	-	0.012	0.006	-	0.179	0.200	-	-	0.292	0.325	-	-
R2H	0.1250	0.3750	-	0.311	0.012	0.006	-	0.179	0.200	-	-	0.300	0.325	-	-
R2-6H	0.1250	0.3750	-	0.315	0.012	-	0.006	0.179	0.200	-	-	0.300	0.325	-	-
R3B	0.1875	0.5000	0.247	-	0.012	0.006	-	0.244	0.276	-	-	0.412	0.446	-	-
R3H	0.1875	0.5000	-	0.436	0.012	-	0.006	0.244	0.276	-	-	0.412	0.446	-	-
R4B	0.2500	0.6250	0.333	-	0.012	0.006	-	0.310	0.365	-	-	0.503	0.565	-	-
R4H	0.2500	0.6250	-	0.530	0.012	-	0.006	0.310	0.365	-	-	0.503	0.565	-	-
R4HX8	0.2500	0.6250	-	0.578	0.012	-	0.006	0.310	0.365	-	-	0.512	0.565	-	-
R8H	0.5000	1.1250	-	1.011	0.016	-	0.008	0.625	0.736	-	-	0.972	1.025	-	-

All dimensions in inches.

When planned applications involve bearing removal and remounting, shoulder dimensions should be selected to facilitate dismounting. Minimum shaft shoulders and maximum housing shoulders are preferred, particularly with interference fits.

Random and Selective Fitting and Calibration

Random fitting of precision bearings entails installation of any standard bearing of a given lot on any shaft or in any housing. In order to retain the performance advantages of precision bearings, the shaft and housing should have the same diametric tolerance as the bearing being used. This procedure will result in some extreme fits due to statistical variations of the dimensions involved.

For applications that cannot tolerate extreme fits, it is usually more economical to use selective fitting with calibrated parts rather than reducing the component tolerances.

Selective fitting utilizes a system of sizing bearings, shafts and housings within a diametric tolerance range and selectively assembling those parts, which fall in the same respective area of the range. This practice can have the advantage of reducing the fit range from twice the size tolerance down to 25% of the total tolerance without affecting the average fit.

Calibration

Bearing calibration can influence the installation and performance characteristics of ball bearings, and should be considered an important selection criteria.

When bearings are calibrated they are sorted into groups whose bores and/or outside diameters fall within a specific increment of the bore and O.D. tolerance. Knowing the calibration of a bearing and the size of the shaft or housing gives users better control of bearing fits.

Barden bearings are typically sorted in increments of either .00005" (0.00125mm) or .0001" (0.0025mm) or, in the case of metric calibration, 1µm. The number of calibration groups for a given bearing size depends on its diametric tolerance and the size of the calibration increment.

Calibration, if required, must be called for in the last part of the bearing nomenclature using a combination of letters and numbers, as shown in Fig. 22. On calibrated duplex pairs, both bearings in the pair have bore and O.D. matched within 0.0001" (0.0025mm).

Random vs. Specific Calibration

Random calibration means the bearing bores and/or O.D.s are measured and the specific increment that the bore or O.D. falls into is marked on the package. With random calibration there is no guarantee of which calibration that will be supplied. Table 52 shows the callouts for various types of random calibration.

Table 52. Random calibrated bearings are ordered by adding the appropriate code to the bearing number according to this table.

Code	Type of Random Calibration
C	Bore and O.D. calibrated in groups of .0001" (0.0025mm).
CXO	Bore only calibrated in groups of .0001" (0.0025mm).
COX	O.D. only calibrated in groups of .0001" (0.0025mm).
C44	Bore and O.D. calibrated in groups of .00005" (0.00125mm).
C40	Bore only calibrated in groups of .00005" (0.00125mm).
C04	O.D. only calibrated in groups of .00005" (0.00125mm).
CM	Bore only calibrate in groups of .0001".

Fig. 22. Example of random calibration nomenclature.

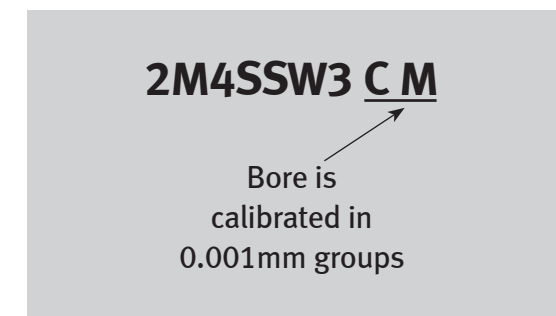
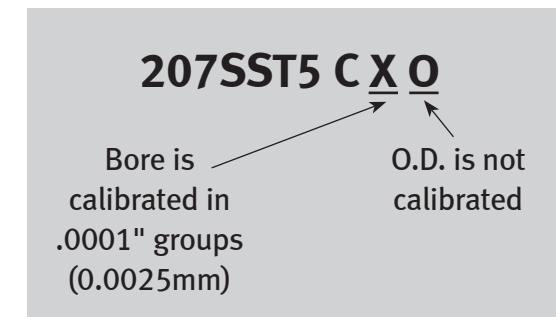

Engineering

Calibration

Specific calibration means the bore and/or O.D. are manufactured or selected to a specific calibration increment. Barden uses letters (A, B, C, etc.) to designate specific .00005" (0.00125mm) groups, and numbers (1, 2, 3, etc.) to designate specific .0001" (0.0025mm) groups. Table 53 shows the letters and numbers, which correspond to the various tolerances increments.

Fig. 24 is exaggerated to help you visualize calibration. The bands around the O.D. and in the bore show bearing tolerances divided into both .00005" (0.00125mm) groups, shown as A, B, C, D and .0001" (0.0025mm) groups, shown as 1, 2, etc.

Table 53. Barden calibration codes for all bearings.

Bore and O.D. Specific Calibration Codes (inch)		
Size Tolerance (from nominal)	.00005" Calib.	.0001" Calib.
Nominal to -.00005"	A	1
-.00005" to -.0001"	B	
-.0001" to -.00015"	C	2
-.00015" to -.0002"	D	
-.0002" to -.00025"	E	3
-.00025" to -.0003"	F	
-.0003" to -.00035"	G	4
-.00035" to -.0004"	H	

Specific Calibration Codes, Bore Only (metric)	
Size Tolerance (from nominal)	Code
Nominal to -0.001mm	CM1
-0.001 to -0.002mm	CM2
-0.002 to -0.003mm	CM3
-0.003 to -0.004mm	CM4
-0.004 to -0.005mm	CM5

If specific calibrations are requested and cannot be supplied from existing inner or outer ring inventories, new parts would have to be manufactured, usually requiring a minimum quantity. Please check for availability before ordering specific calibrations.

Selective fitting uses a system of sizing (coding) bearings (calibration), shafts and housings and selectively assembling those parts which fall in the same code, effectively allowing users to obtain the desired fit.

Fig. 23. A typical example of specific calibration.

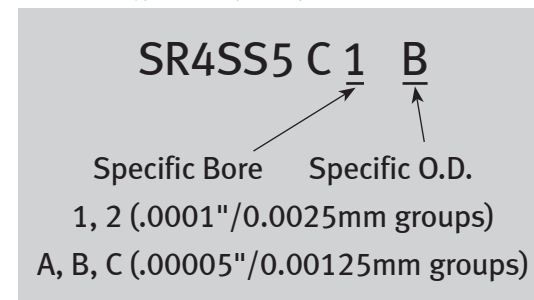
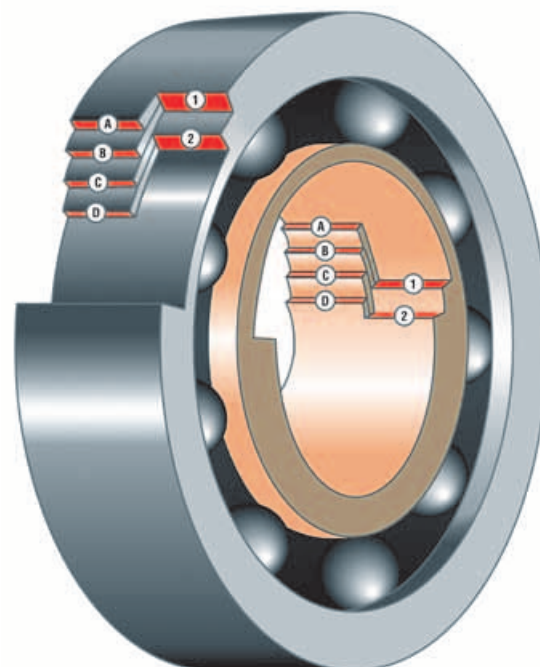

Fig. 24. This drawing, grossly exaggerated for clarity, illustrates specific calibration options (inch) for bore and O.D.



Maintaining Bearing Cleanliness

It is vital to maintain a high degree of cleanliness inside precision bearings. Small particles of foreign matter can ruin smooth running qualities and low torque values.

Three types of dirt and contaminants can impede a bearing's performance:

1. Airborne contaminants — lint, metal fines, abrasive fines, smoke, dust.
2. Transferred contaminants — dirt picked up from one source and passed along to the bearing from hands, work surfaces, packaging, tools and fixtures.
3. Introduced dirt — typically from dirty solvents or lubricants.

Contaminants that are often overlooked include humidity and moisture, fingerprints (transferred through handling), dirty greases and oils, and cigarette smoke. All of the above sources should be considered abrasive, corrosive or leading causes of degradation of bearing performance. It should be noted that cleanliness extends not just to the bearings themselves, but to all work and storage areas, benches, transport equipment, tools, fixtures, shafts, housings and other bearing components.

When using oil lubricating systems, continuously filter the oil to avoid the introduction of contaminants.

Sometimes, as shown here, the effects of contamination are barely visible.

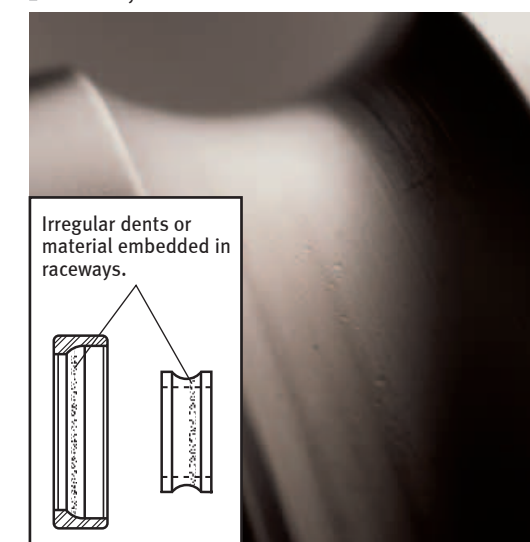

Comparison of relative sizes of typical contaminants. Oil film under boundary lubrication conditions is only 0.4 micrometers thick, and can be easily penetrated by even a single particle of tobacco smoke.

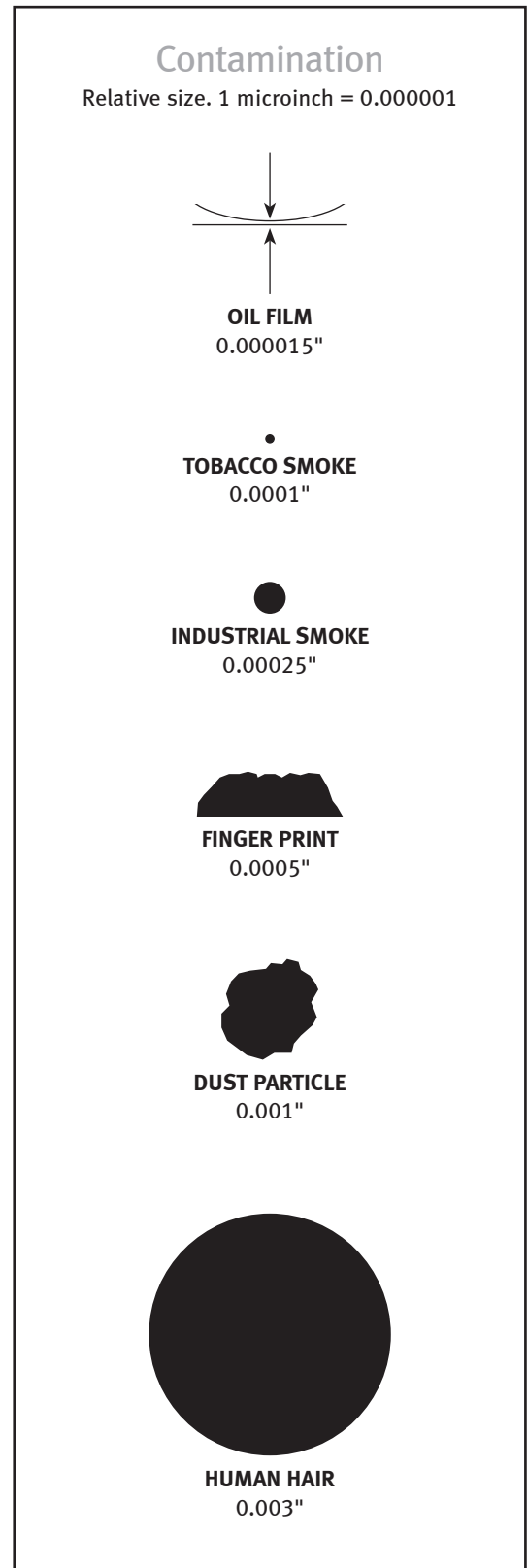

Engineering

Maintaining Bearing Cleanliness

Use of Shields and Seals

As a rule, it is unwise to mount bearings exposed to the environment. Wherever possible, shielded or sealed bearings should be used, even when enclosed in a protective casing. In situations where inboard sides of bearings are exposed in a closed-in unit, all internal surfaces of parts between the bearings must be kept clean of foreign matter.

If it is impossible to use shielded or sealed bearings, or in cases where these are not available (for example, most sizes of angular contact bearings), protective enclosures such as end bells, caps or labyrinth seals may be used to prevent ambient dust from entering the bearings.

Handling Precision Bearings

All too often bearing problems can be traced back to improper handling. Even microscopic particles of dirt can affect bearing performance.

Precision bearing users should observe proper installation techniques to prevent dirt and contamination.

Foreign particles entering a bearing will do severe damage by causing minute denting of the raceways and balls. The outward signs that contamination may be present include increased vibration, accelerated wear, the inability to hold tolerances and elevated running temperatures. All of these conditions could eventually lead to bearing failure.

Close examination of inner or outer ring races will show irregular dents, scratches or a pock-marked appearance. Balls will be similarly dented, dulled or scratched. The effects of some types of contamination may be hard to see at first because of their microscopic nature.

Work Area

“Best Practice” bearing installation begins with a clean work area, a good work surface and a comprehensive set of appropriate tooling — all essential elements in order to ensure effective bearing handling and installation.

Good workbench surface materials include wood, rubber, metal and plastic. Generally, painted metal is not desirable as a work surface because it can

chip, flake or rust. Plastic laminates may be acceptable and are easy to keep clean, but are also more fragile than steel or wood and are prone towards the build up of static electricity. Stainless steel, splinter-free hardwoods or dense rubber mats that do not shred or leave oily residues are the preferred choice.

A clutter-free work area, with good lighting, organized tool storage, handy parts bins and appropriate work fixtures constitutes an ideal working environment.

Under no circumstances should food or drink be consumed on or near work surfaces. Smoking should not be allowed in the room where bearings are being replaced. Bearing installation operations should be located away from other machining operations (grinding, drilling, etc.) to help minimize contamination problems.

Static electricity, as well as operations that may cause steel rings and balls to become magnetized, could result in dust of fine metallic particles being introduced into the bearing. Since all Barden bearings are demagnetized before shipment, if there are any signs that the bearings have become magnetically induced then they should be passed through a suitable demagnetizer while still in their original sealed packaging.

Proper Tools

Every workbench should have a well-stocked complement of proper tools to facilitate bearing removal and replacement. Suggested tools include wrenches and spanners (unplated and unpainted only), drifts, gauges, gauge-blocks and bearing pullers.

Most spindle bearings are installed with an induction heater (using the principle of thermal expansion) which enlarges the inner ring slightly so that the bearing can be slipped over the shaft. An arbor press can also be used for installing small-bore instrument bearings.

Bearing installers may also require access to a variety of diagnostic tools such as a run-in stand for spindle testing, a bearing balancer and a portable vibration analyzer.

Handling Guidelines

All Barden bearings are manufactured, assembled and packaged in strictly controlled environments. If the full potential of precision bearings is to be realized then the same degree of care and attention must be used in installing them. The first rule for handling bearings is to keep them clean. Consider every kind of foreign material — dust, moisture, fingerprints, solvents, lint, dirty grease — to be abrasive, corrosive or otherwise potentially damaging to the bearing precision. Barden recommends that the following guidelines are used when handling its precision bearings. Particular attention should be made when installing or removing the bearings from shaft or housing assemblies.

1. Keep bearings in their original packaging until ready for use. Nomenclature for each Barden bearing is printed on its box, so there is no need to refer to the bearing itself for identification. Moreover, since the full bearing number appears only on the box, it should be kept with the bearing until installation.
2. Clean and prepare the work area before removing bearings from the packaging.
3. All Barden bearings are demagnetized before shipment. If there is any indication of magnetic induction that would attract metallic contaminants, pass the wrapped bearings through a suitable demagnetizer before unpacking.
4. Once unpacked, the bearings should be handled with clean, dry, talc-free gloves. Note that material incompatibility between the gloves and any cleaning solvents could result in contaminant films being transferred to the bearings during subsequent handling. Clean surgical tweezers should be used to handle instrument bearings.
5. Protect unwrapped bearings by keeping them covered at all times. Use a clean dry cover that will not shed fibrous or particulate contamination into the bearings.
6. Do not wash or treat the bearings. Barden takes great care in cleaning its bearings and properly pre-lubricating them before packaging.
7. Use only bearing-quality lubricants, and keep them clean during application, and covered between uses. For greased bearings, apply only the proper quantity of grease with a clean applicator. Ensure that all lubricants are within the recommended shelf life before application.
8. For bearing installation and removal only use clean, burr-free tools that are designed for the job. The tools should not be painted or chrome plated as these can provide a source of particulate contamination.
9. Assemble using only clean, burr-free parts. Housing interiors and shaft seats should be thoroughly cleaned before fitting.
10. Make sure bearing rings are started evenly on shafts or in housings, to prevent cocking and distortion.
11. For interference fits, use heat assembly (differential expansion) or an arbor press. Never use a hammer, screwdriver or drift, and never apply sharp blows.
12. Apply force only to the ring being press-fitted. Never strike the outer ring, for example, to force the inner ring onto a shaft. Such practice can easily result in brinelling of the raceway, which leads to high torque or noisy operation.
13. Ensure that all surrounding areas are clean before removing bearings from shaft or housing assemblies. Isolate and identify used bearings upon removal. Inspect the bearings carefully before re-use.
14. Keep records of bearing nomenclature and mounting arrangements for future reference and re-ordering.

Notes

A series of horizontal dotted lines for writing notes.

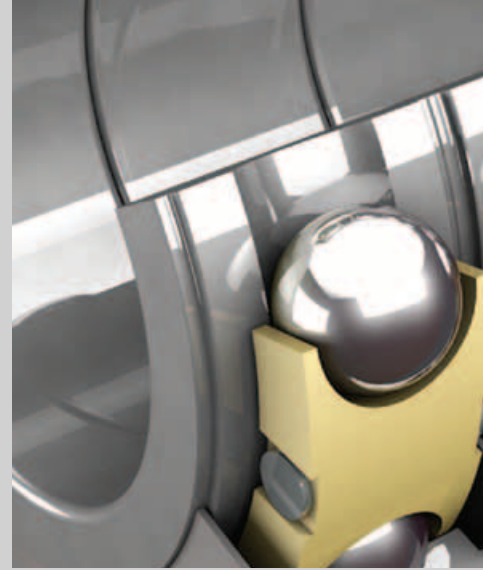

The Barden Corporation (UK) Ltd

Plymbridge Road, Estover,
Plymouth, Devon PL6 7LH UK

Telephone: +44 (0)1752 735555

Fax: +44 (0)1752 733481

Email: bardenbearings@schaeffler.com

www.bardenbearings.co.uk

The Barden Corporation

200 Park Avenue, Danbury,
Connecticut, CT 06810, USA

Telephone: +1 0203 744 2211

Fax: +1 0203 744 3756

Email: sales@bardenbearings.com

www.bardenbearings.com

Every care has been taken to ensure the information contained in this publication is correct. However no liability can be accepted for any errors or omissions. This publication or parts thereof may not be reproduced without permission.

© Barden Corporation 2013