

An invention prevails.



Antifriction Bearings, Linear Systems The Special Solution for Every Industry



Medical technology computer tomography medical supplies examination tables operating tables x-rays textile industry circular knitting machines flat knitting machines knitting machines mechanical engineering industry rotary tables tool changers welding plants laser cutting stone saws robotic pick and place portal robots transfer systems handling systems bending arm robots clean room wafer steppers chip production satellite technology food industry racks agitators cheese production packaging industry lifting gear film packaging reeling machines mattress packaging optics laser positioning glasses production

Customised work. Yesterday. Today. Tomorrow.

Erich Franke invented the Antifriction Bearing in 1934, which impressed both with its flexibility and load capacity. Since our beginnings almost 60 years ago, everything in our company has revolved around the Antifriction Bearing. Today, Franke is a synonym for extensive experience and absolute precision in Antifriction Bearings and Linear Systems.



We develop and produce Antifriction Bearings and Linear Systems, which are precisely adjusted to suit the needs of our customers. At our southern German headquarters in Aalen, we employ more than 200 people for this purpose in development and design, production and administration. Our managers steer the company's skills from here. We have a global presence with many branch offices.





“Antifriction Bearings and Linear Systems made to measure – supported by our know-how, modern production facilities and committed staff. You reap the rewards!”



The Franke Principle – Antifriction Bearings Bearing Elements

Type LEL, LED, LER, LEG, LDD

Patented precision.

Mechanical processes are circular; our bearings make it possible. They comprise four race rings, balls, a ball cage and, on request, enclosed design.

They are based on a patented principle: four race rings form the heart of the bearing. Thanks to a specially developed grinding procedure they fit their raceway – exactly adjusted to the ball diameter. Therefore, the rolling process does not occur directly between the rolling elements and enclosed design, but rather smoothly on the four open race rings. Thanks to the 4-point contact, the systems can take loads of any level from all directions.

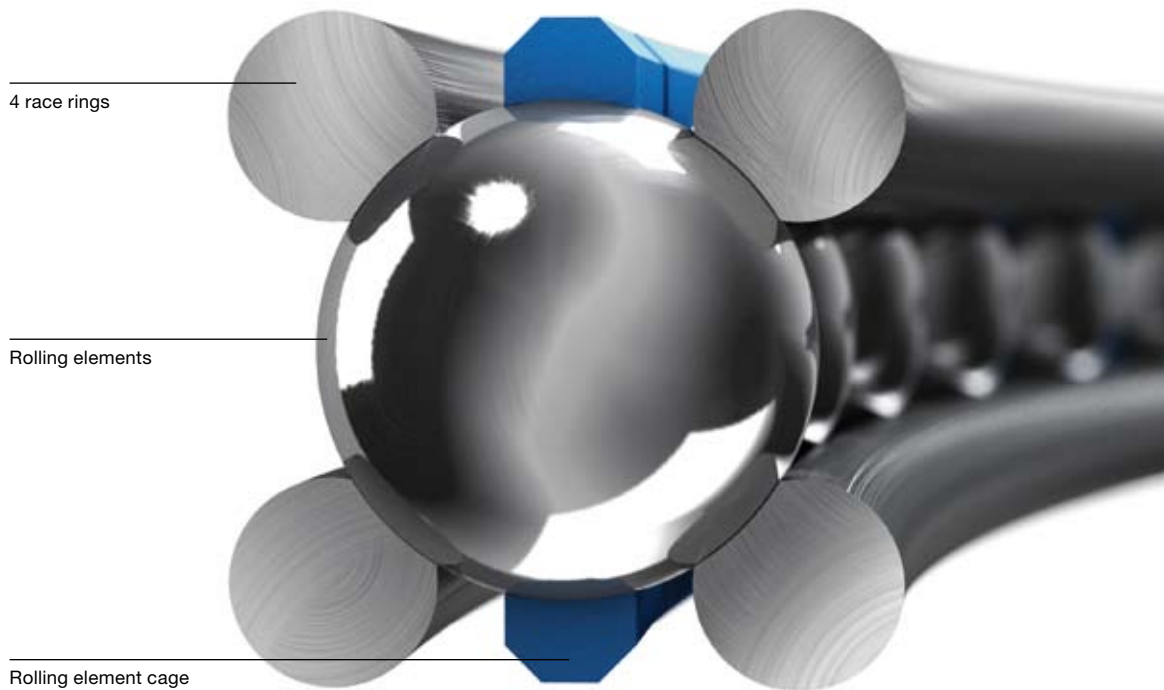

The Advantages:

- Direct integration of the bearing in the application
- Minimum space needed thanks to compact design and low bearing cross section
- Acceptance of loads from all directions thanks to four-point geometry
- Best radial and axial accuracy
- High running performance and capacity thanks to raceways precisely adjusted to the ball diameters
- Shock-resistant thanks to internal elasticity
- Rotational resistance freely adjustable

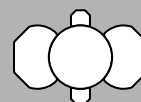
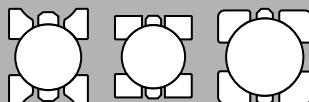
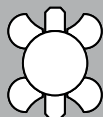
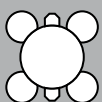

Bearing Assemblies

Type LDL, LDV, LDH

Ready-for-connection precision.

Bearing assemblies comprise a Franke Bearing Element, an outer and inner ring (geared on request) and a lip seal. Depending on the application of the bearing assembly, the Bearing Element is designed as a 4-point bearing, radial or axial bearing. There are two-row angular bearings in various designs for special applications.

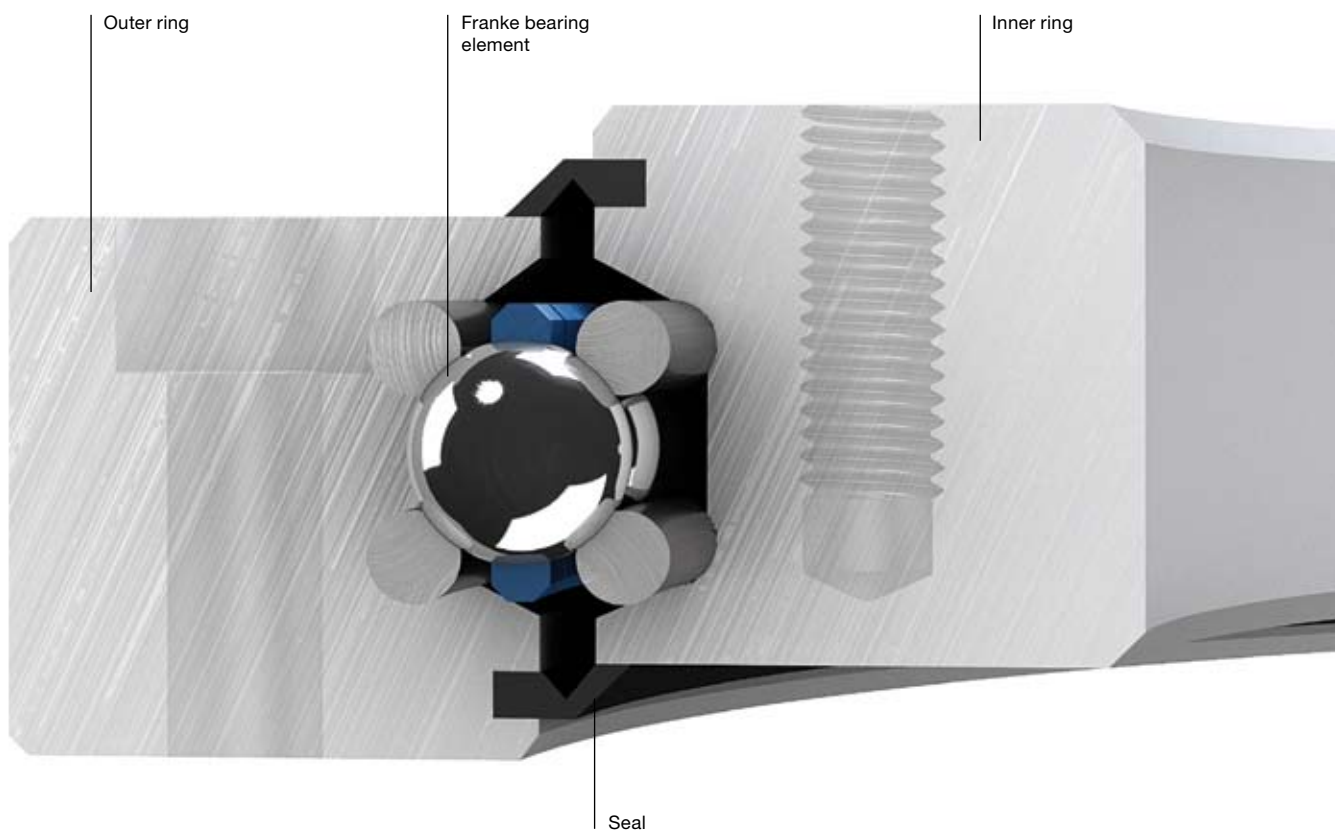

The Advantages:

- Customer-specific special bearing
- Free choice of material, aluminium version 65 % lighter than steel design
- Individually adjusted bore shape for direct attachment to the connecting design
- Integrated Franke bearing element for loads from all directions, high performance and precision
- High dynamic, maximum peripheral speed up to 20 m/s

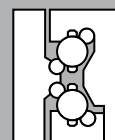
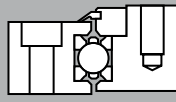
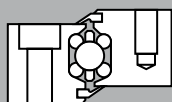
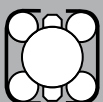

Antifriction Bearings from Franke. All extras included.

Special requests are our business: we are experts in special bearings and satisfy unusual wishes when it comes to Antifriction Bearings. We offer a broad range of options for this purpose. Parameters such as load rating, stiffness, preload and adjustment are just as variable as height, width and bore shape or the different materials.



There are broad design possibilities for designers who use Franke Antifriction Bearings: the choice of design and material for the surrounding component is flexible. Steel, aluminium, non-corrosive, plastic or brass – our customers have free choice. This applies equally to the rolling elements, cages and race rings. There are different materials available for these too. The adjust-

Lubricant-free



Anodized aluminium



Special gear



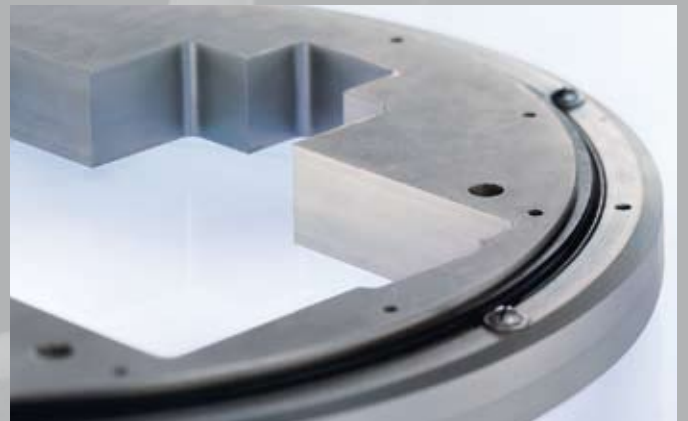

ability of the bearings does not stop there: we have different gears, seals, diameters, ball profiles etc. for our customers.

It is not just the selection range that is unique, but also the way the bearings are made: in contrast to conventional bearings, the rolling process does not occur directly between the rolling

elements and enclosed design, but rather smoothly on four open race rings. The raceways are matched to the ball diameter using a special grinding process. This special design principle produces an extremely compact bearing, which also suits very small spaces. Another plus: the low friction and high load capacity of our Antifriction Bearings reduce energy consumption.

Special rolling elements



Special cages



Special seals



Antifriction Bearings in Practice



After in-depth consultation and precise design and production, Franke Antifriction Bearings provide movement in diverse applications. For example, in computer tomography, processing centres, textile machinery, machinery for chip production, indexing tables or robots. Our Antifriction Bearings pass the practical test day after day – you can rely on that.

Selected Industry Examples

In Medical Technology: Computer Tomography

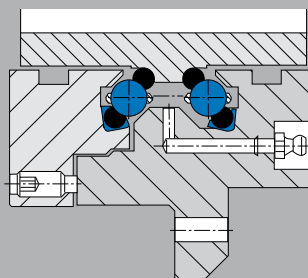

Photo credit: Siemens AG

The patented Franke **Fluesterlager**® as the main bearing in computer tomography contributes to exact x-rays thanks to its design tailor-made to the needs of medical technology.

The Features:

- Smooth and low-vibration running is even ensured at high rotary speeds thanks to CNC-ground raceways.
- The elastomer profiles between the race rings and the race ring bed form the basis for muted noise development and electrical insulation of the inner and outer ring.
- The silent bearing impresses with rotary speeds of up to 300 revolutions per minute.



Ball diameter: 12 mm
Bearing diameter: 1500 mm

In Machinery: Machining Centres

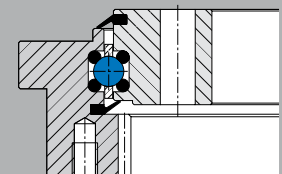

Photo credit: Hermle AG

In tool changers at machining centres, our bearing assemblies help to ensure that different tools are fed quickly and precisely into the machining head.

The Features:

- Due to the high centre freedom of the bearing assemblies, the drive system can be installed to the inside.
- Labyrinth seals protect the raceways of the bearing assemblies from chipping and coolants.
- The preload of the bearing guarantees high accuracy and even adjustment – thus, nothing stands in the way of quiet running and maximum precision.



Ball diameter: 9.525 mm
Bearing diameter: 970 mm



In Machinery: Indexing Tables

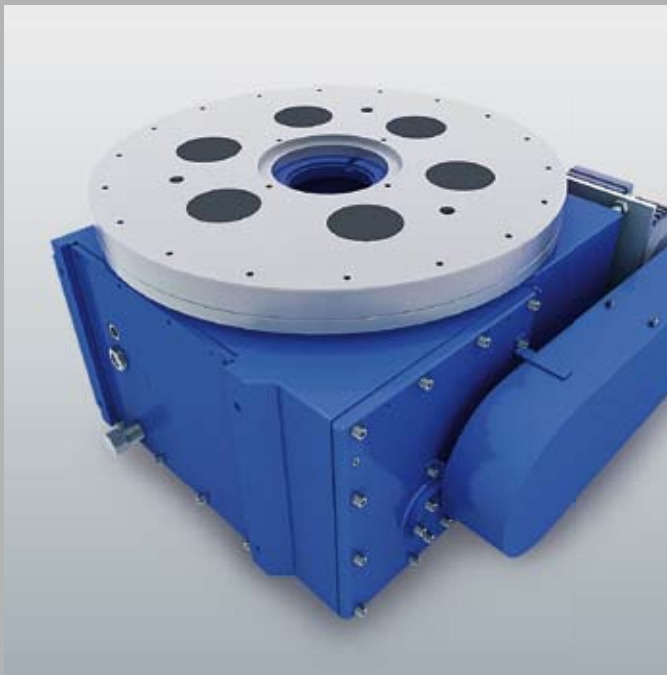

By using indexing tables, also called Rotary Tables, tools are moved precisely. The constant and precise movement of these indexing tables is based on our bearing elements amongst other things.

The Features:

- The bearing elements are precisely adjusted to the different loads. Enormous loads can easily be borne from all directions.
- The Antifriction Bearings guarantee that the Rotary Table can move without jerks or shocks, high repeat accuracy is included.

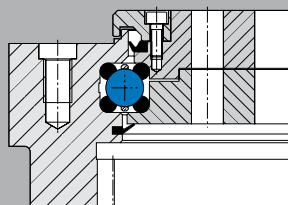

Ball diameter: 20 mm
Bearing diameter: 800 mm

In Automation: Robots



Our bearing elements are ideally suited for use in the mobile axles of small robots.

The Features:

- The ingenious 4-point system from Franke facilitates high capacity from all directions of movement.
- As the bearing element is integrated into the existing robot design, only minimal installation space is needed.
- The high centre freedom of the bearing enables cables and supply pipes to be fed through.

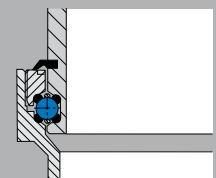

Ball diameter: 6 mm
Bearing diameter: 240 mm

The Franke Principle – Linear Systems

Aluminium Roller Guide Franke Dynamic

Type FDA – FDH

Perfection from principle.

Aluminium Linear Systems from Franke are the best solution when you need translational motion. The essential components of these durable systems: Aluminium Linear Systems, specially designed raceways, cassettes or pairs of roller shoes with rollers.

Thanks to the patented guide system, the rollers are perfectly placed in the guide rails on four raceways. The 4-point contact takes loads from all directions.

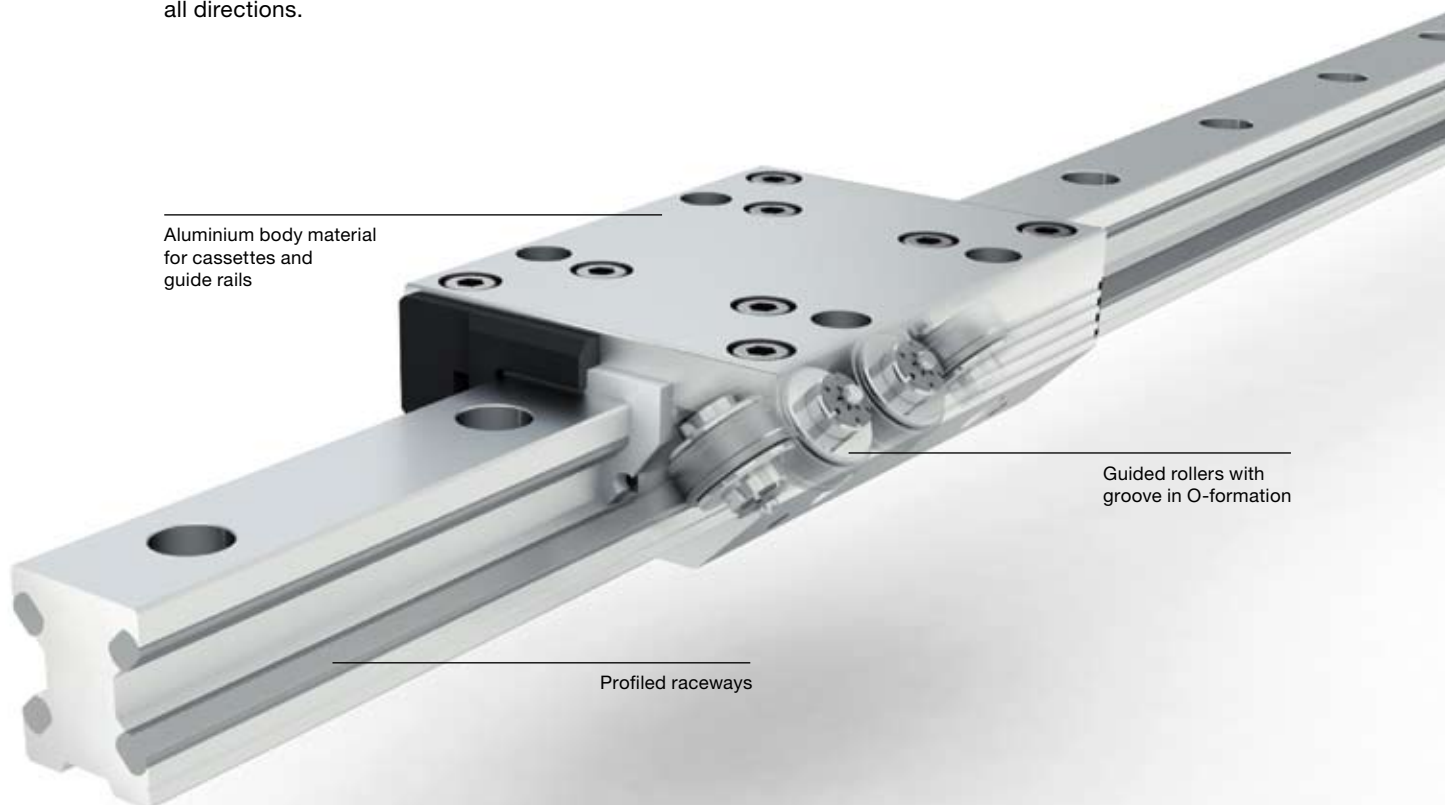

The Advantages:

- Low weight thanks to aluminium body material
- Silent and easy running thanks to the patented **Guided Roller®**
- Maintenance-free and clean
- O-formation for equal loads from all directions
- High traverse speed and acceleration
- Numerous variations for almost any application
- Customer-specific solutions if series needed

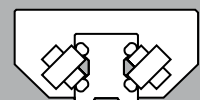

Numerous Possibilities

The Different Types:

Type FDA	Standard
Type FDB	Low cost
Type FDC	Non-corrosive
Type FDD	Non-magnetic
Type FDE	Lubricant-free
Type FDG	Non-corrosive low cost
Type FDH	High dynamic

We can also supply special cassettes in specific dimensions, heat-resistant versions and vacuum-fit for series production. Please call us.

No lubricant residue



Aluminium profiles



Diverse Roller Shoes



The Characteristics:

Cassettes and Roller Shoes

The cassette of the Franke Dynamic Aluminium Roller Guide has aluminium body material with needle or ball bearing rollers of steel or non-corrosive. Special cover discs on the roller seal the bearing to the outside.

Eight rollers in O-formation guarantee an equally high load capacity from all directions. Thanks to the patented system of the guided roller, the rollers are laterally guided. This guarantees evenly light and quiet running.

Wipers

The bearings of the rollers are sealed and have lifetime lubrication. Felt strippers guarantee permanent protection of the guide systems against dirt.

Guide Rails

The raceways of spring steel, non-corrosive or non-magnetic steel are integrated in the aluminium profile. The O-formation guarantees high load capacity from all directions.

Aluminium Recirculating Roller Guide Franke Power

Type FPA

The Advantages:

- High load capacity and stiffness
- Connecting dimensions compatible with international standards
- Integrated metal wipers
- All-round sealing

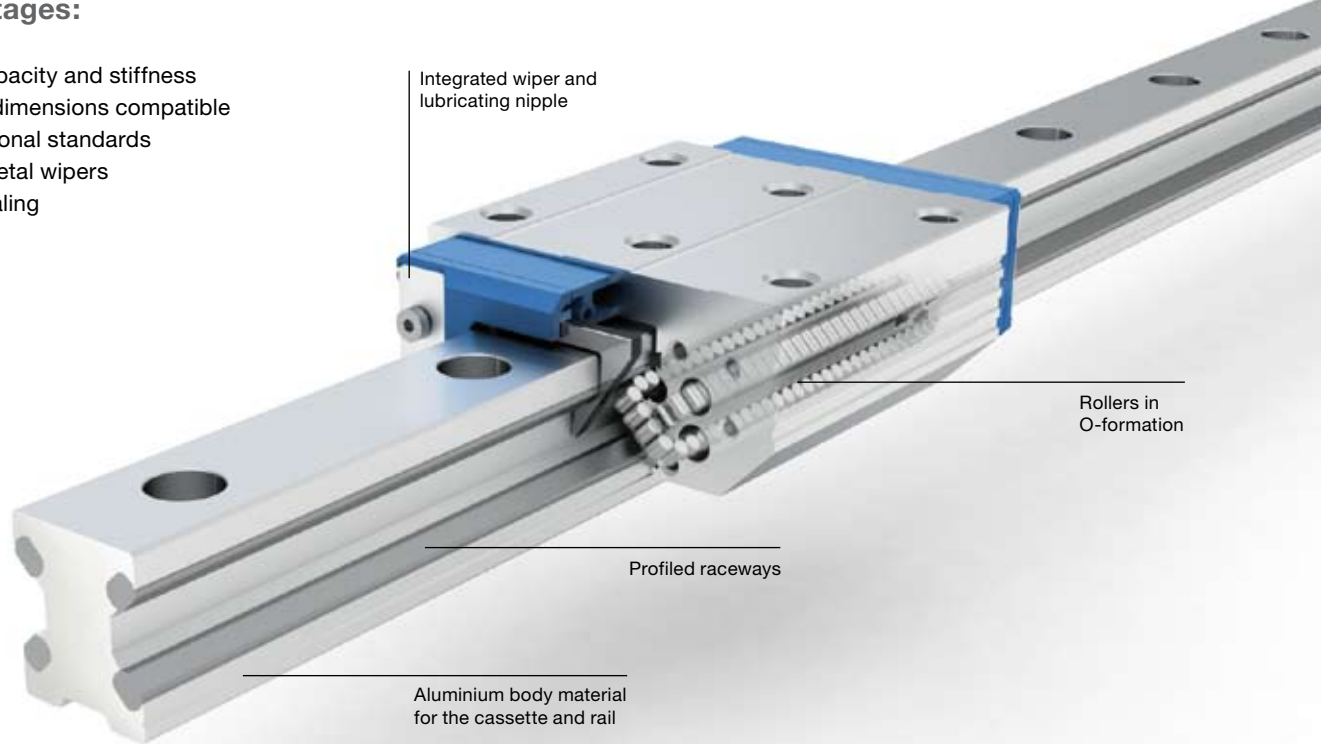

The Characteristics:

Cassette

The cassette of the Franke Power Aluminium Recirculating Roller Guide is made from special aluminium with fixing bores. The recirculating rollers in 90°-formation guarantee even, high load capacity and loading from every direction. Each cassette has a lubrication nipple, which can be attached to one of the four front ends. A defined slide resistance ensures alignment on the guide rails.

Guide Rails

Raceways of spring steel, non-corrosive or non-magnetic steel are integrated in the aluminium profile. High load capacity from all directions is guaranteed by the O-formation. The profile of the rollers is adjusted to the raceway and ensures precise and easy running permanently.

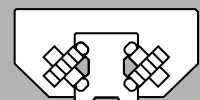

Aluminium Recirculating Ball Guide Franke Robust

Type FRA

The Advantages:

- High load capacity, high security
- High lifetime and profitability
- Robust, also in harsh conditions
- Shock and impact-resistant

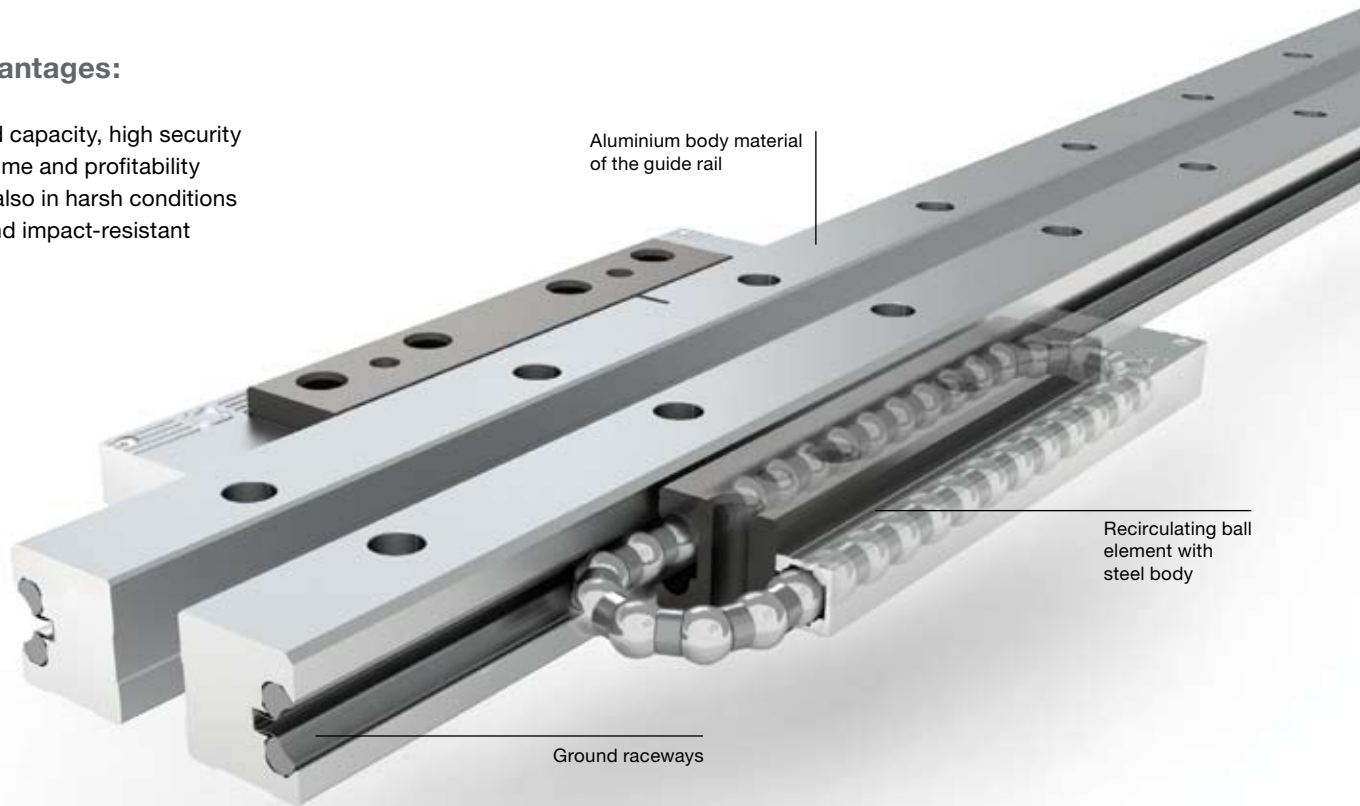

The Characteristics:

Recirculating Element

The Franke Robust Recirculating Ball Guide proves itself in the most diverse applications and industries. It works reliably in machinery, in robotics, portals and in transport.

The recirculating elements have a compact and robust design. The balls are kept apart by plastic wipers, which prevents any friction. The result: good running performance and long lifetime.

Guide Rails

The high load capacity of the guide results from precise adjustment of the raceways to the balls. Embedded raceways of spring steel or non-corrosive adjust to the load and can be exchanged as needed. Thus, complete raceways can be replaced cheaply without dismantling the rails.

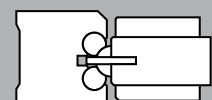

Linear Systems in Practice

The Franke principle of the guided roller guarantees easy and silent running, even at high speeds. These factors are essential for smooth production in many industries. Therefore, Franke Linear Systems are also used in the most diverse industrial sectors – for example in medical technology, the food industry, for machine and plant engineering or in the handling sector.



Selected Industry Examples

In Medical Technology: Dental X-Ray Equipment



Precise x-rays need the movement of the light unit to be completely vibration-free. Therefore, the roller guide used must have smooth and silent running. The Franke Dynamic Aluminium Roller Guide fulfils this demand perfectly.

The Features:

- The Franke Dynamic Aluminium Roller Guide has lifetime lubrication.
- Sealed rollers prevent the lubricant escaping.
- The guide's running is silent, smooth and even.
- Preloading the cassette ensures vibration-free movement of the secondary light.

In Plant Engineering: Packaging Machines



The Franke Dynamic Aluminium Roller Guide is also used on packaging machinery for mattresses. In addition to cleanliness, the mobile function of the guide unit must be ensured, to avoid soiling the mattresses.

The Features:

- The Franke Dynamic Aluminium Roller Guide is maintenance-free and requires no relubrication.
- No lubricant can escape from the encapsulated rollers.
- The guide is available in a completely lubricant-free design on request.



In the Food Industry: Cheese Production



In cheese production the food-safe Franke Dynamic Aluminium Roller Guide provides the vertical movement of a grappler for wheels of cheese. In this application it is important that the roller guide is insensitive to whey and aggressive cleaning agents.

The Features:

- The guide is insensitive to moisture.
- Its running is easy and silent, the drive power is low.
- No maintenance and lubrication for the whole lifetime are guaranteed.
- An integrated wiper fulfils the specific hygiene requirements for food production.
- The product is available in a lubricant-free version on request.

In the Packing Industry: Packaging Machines

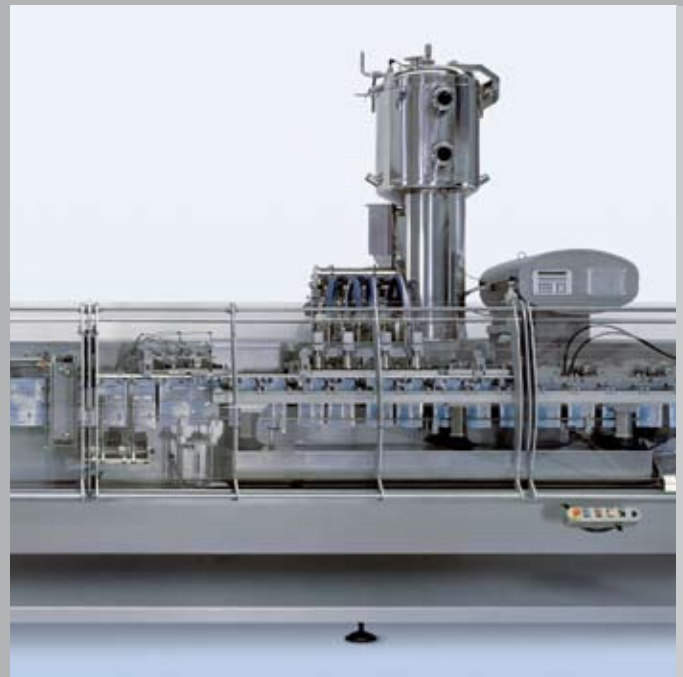

A bag forming, filling and sealing machine works at high speeds. It has stroke lengths of 1500 to 2100 mm, the average service performance is 30000 kilometers a year. The Franke Dynamic Aluminium Roller Guide used must be resistant to the aggressive environmental conditions, such as salt, sugar and splash water.

The Features:

- The Franke Dynamic Aluminium Roller Guide is in a position to realise speeds up to 10 m/s.
- Several guides can be coupled for any length of stroke desired.
- A good lifetime and service performance are achieved through central lubrication of the cassette.

Please give us a ring if you have any questions or would like advice.
Visit us on the Internet. You will find lots of information on our products and
our company here.

www.franke-gmbh.com

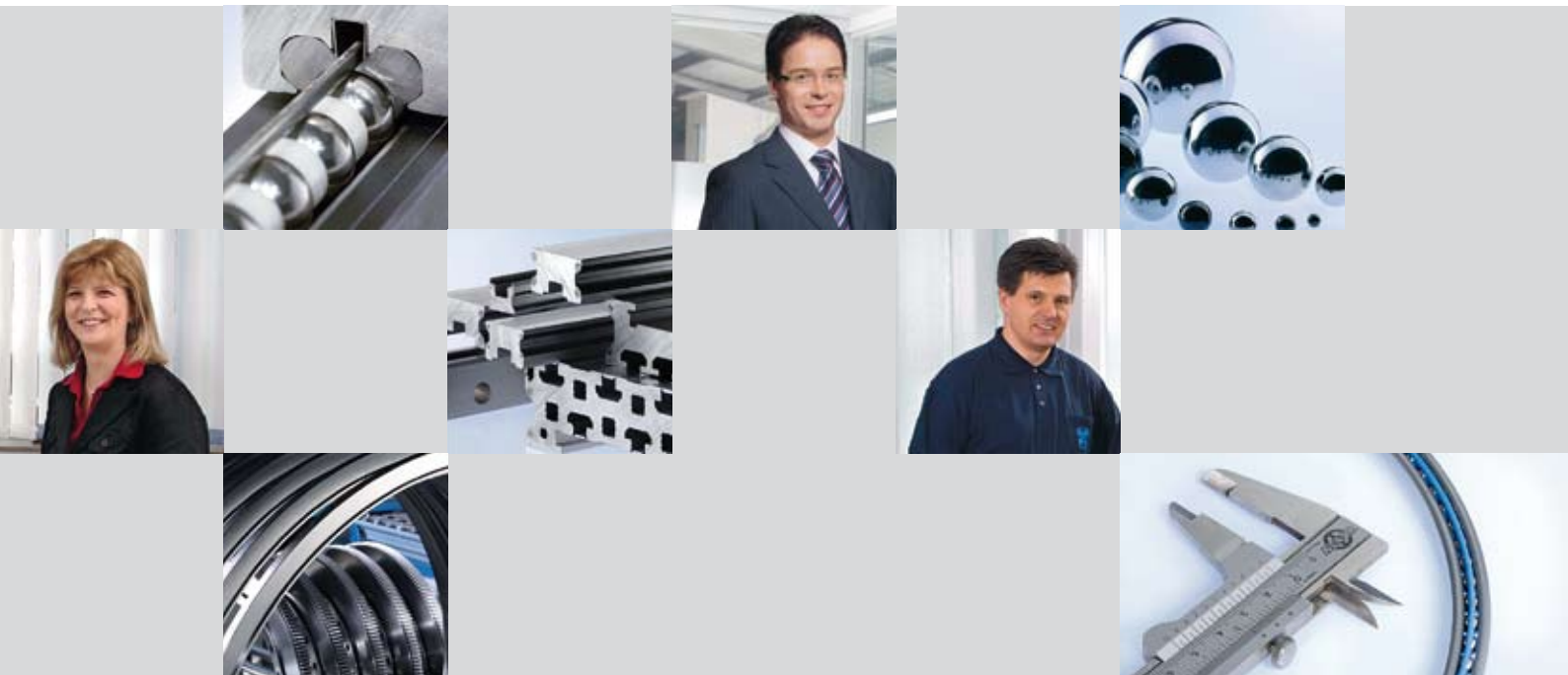

Consultation feedback construction tools calculation
design training test series prototypes site visits in-house
exhibitions sample parts

Franke GmbH
Obere Bahnstraße 64
73431 Aalen, Germany
Tel. +49 7361 920-0
Fax +49 7361 920-120
info@franke-gmbh.de
www.franke-gmbh.com

**Certified in accordance with
ISO 9001:2000
ISO 14001:2004**