

OVERVIEW

THE ORIGINAL  
SPLIT  
ROLLER  
BEARING

Visit [CooperBearings.com](http://CooperBearings.com)



**COOPER**<sup>®</sup>

an SKF Group brand

**SKF**

## THE COMPANY

Since inventing **the split roller bearing in 1907**, Cooper has become synonymous with the **manufacture of quality, long-lasting products.**

Based in the UK, Cooper designs and manufactures bearings and bearing housings on the same site using the latest in cellular, flexible techniques and machinery. These modern methods are underpinned by the experience and

commitment of our workforce with an average length of service in excess of 15 years.

Direct, specialised engineering support is available from our offices in the USA,

Germany, India and Australia. Together with the local support and assistance of a global network of prestigious, authorised distributors, customers worldwide can be assured of "First In Class" service and attention.

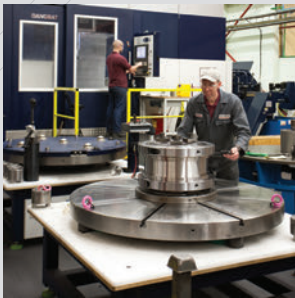

## THE PRODUCT

Cooper split bearings are the ideal solution for reduction of machinery maintenance/repair downtimes whether planned or through failure of the original bearing. The advantages of the Cooper split bearing solution are especially valuable in inaccessible or trapped locations e.g between head pulley and gearbox or motor, where the need to dismount associated equipment is eliminated.

Split to the shaft bearings disassemble into smaller components easing the tasks of lifting and handling and making assembly or change-out simple even in the most cramped and inaccessible conditions

Clearances are pre-set, so no on-site adjustment is needed and no specialist fitting tools are required

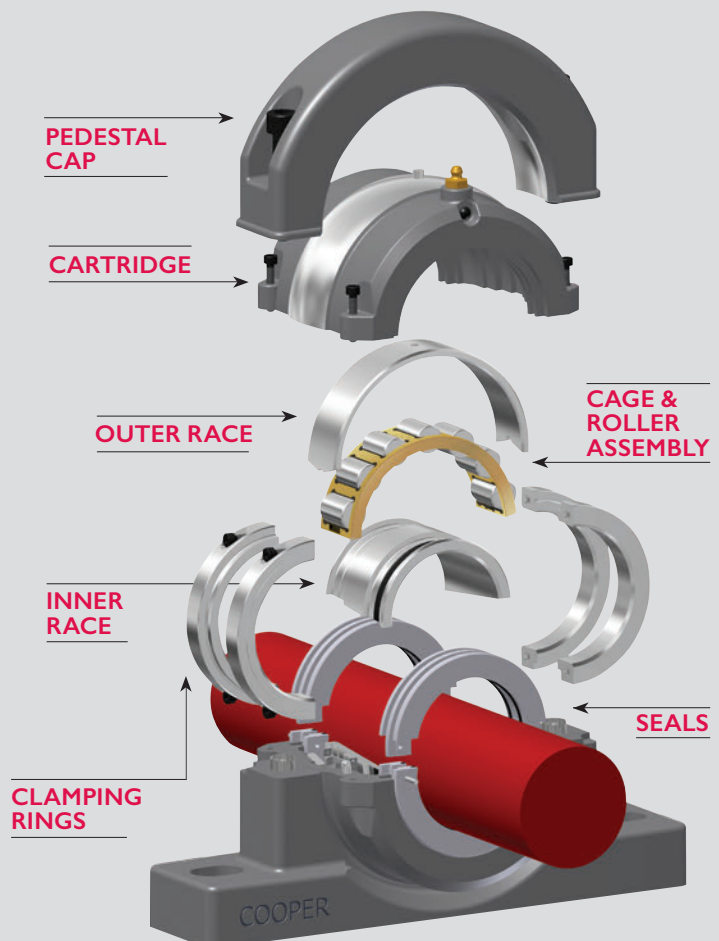

## BEARING SERIES

The current offering is the broadest on the market, comprising 4 series of cylindrical roller bearing AND two types of split taper roller bearing.

The standard manufacturing range is available for bore sizes from 30 mm to 1500 mm. (incl. inch equivalents).

A comprehensive array of customisation options to the standard design is also available. These include special internal clearances, lip configurations etc.

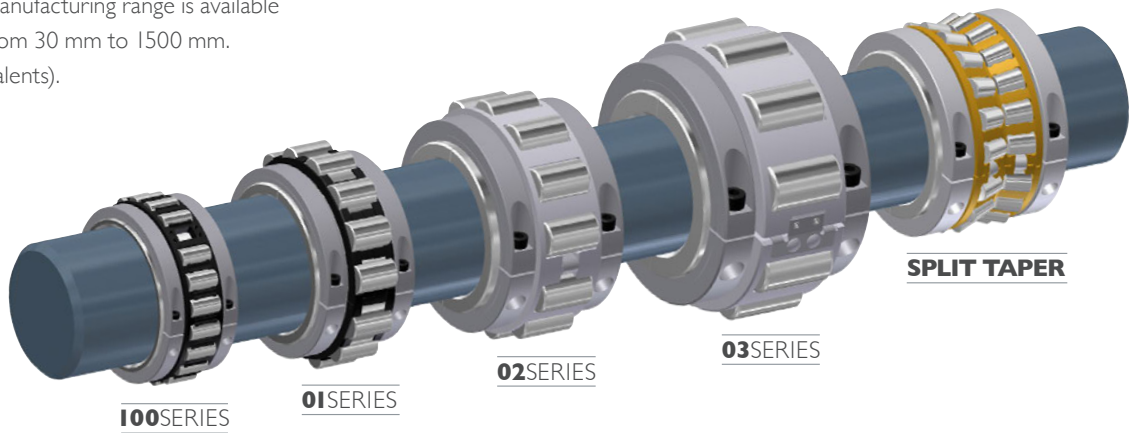

## HOUSING TYPES

Cooper is the only manufacturer of split bearings to have its own integrated foundry, ensuring attention to quality to both the bearing and its housing.

Housings are produced and machined in a variety of configurations and in a variety of materials, e.g.: grey cast iron grade 250, nodular iron, steel, aluminium and stainless steel.



HANGER UNITS

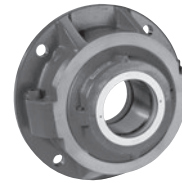

ROUND FLANGE UNITS

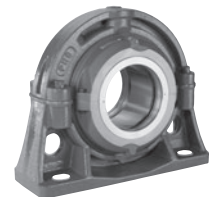

LARGE BORE BASE

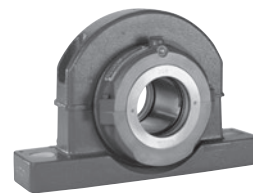

TWO BOLT BASE

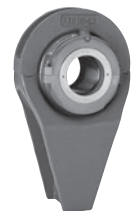

ROD END UNITS

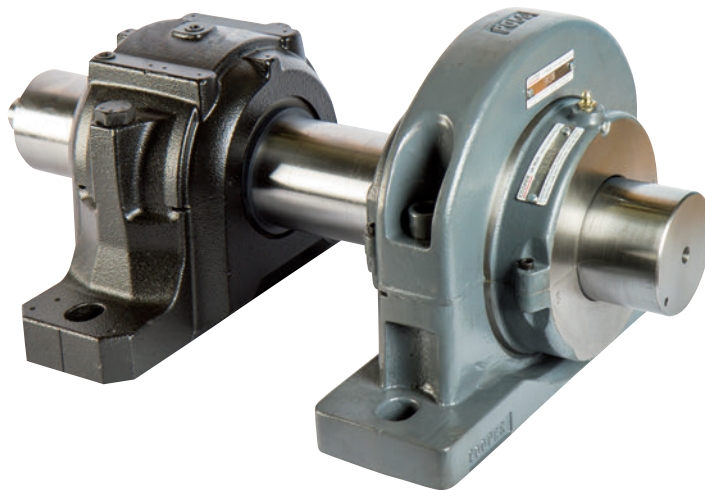

SN/SD COMPATIBLE HOUSINGS

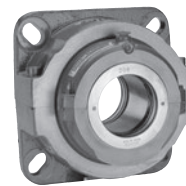

SQUARE FLANGE UNITS



TAKE-UP UNITS

## BEARING TYPES

### EXPANSION (EX)

The inner race is clamped to the shaft, and moves axially with it when expansion or contraction occurs. The Cooper expansion bearing offers virtually no resistance to axial movement as the rollers spiral through the outer race.

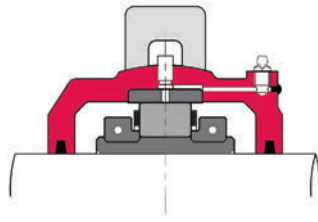

### FIXED (GR)

Provides axial location to the rotating elements of machinery. Can sustain axial and radial loads.

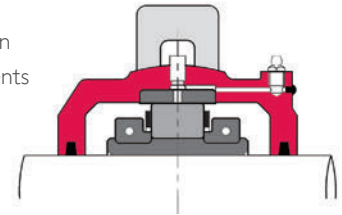

## SEALING TYPES

Efficient performance and long bearing life depend, to a great degree, on the exclusion of foreign matter from the internal bearing surfaces.

Due to the external alignment via the seal-carrying cartridge, seals on Cooper bearings always work perpendicular to the shaft affording optimum protection from potential damage from abrasive materials such as cement or sugar.

Cooper offers a wide range of sealing options to suit different requirements and operating environments

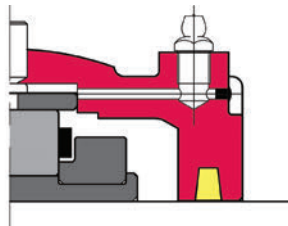

**FELT (F)**

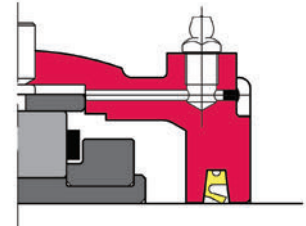

**SYNTHETIC RUBBER SINGLE LIP (SRS)**  
High temperature version (SRS HT)  
Low temperature version (SRS LT)

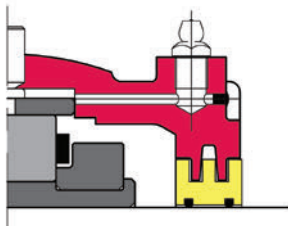

**ALUMINUM TRIPLE LABYRINTH (ATL)**  
High temperature version (ATL HT)  
Low temperature version (ATL LT)

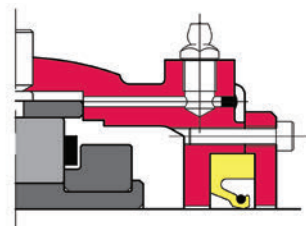

**SPRING-LOADED SINGLE LIP WITH RETAINING PLATE (SRSRP)**  
High pressure version (SRSRP 40M)

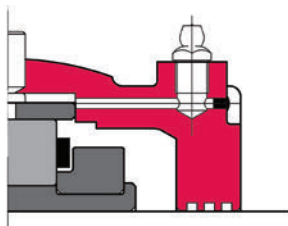

**GREASE GROOVE (LAB)**

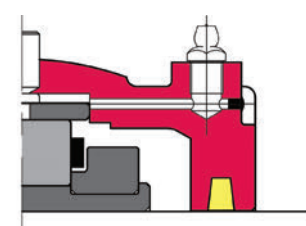

**HIGH TEMPERATURE PACKING (HTP)**



## APPLICATIONS

### INTRODUCTION

The following images show Cooper Split Roller Bearings "in action" across a range of industries and applications. The examples shown underline the key

advantages in terms of ease of installation, inspection and replacement, as well as graphically illustrating the superior efficiency of the Cooper

sealing solution in even the most adverse environments.



### BELT CONVEYOR

In trapped locations such as this, split bearings ensure significant savings in maintenance and downtime, due to eliminating the need to dismount and refit important associated components.



### BELT CONVEYOR

The pedestal unit in a "trapped" position on a cement conveyor graphically illustrates how the efficient sealing system can ensure long bearing life in even the most adverse environments.

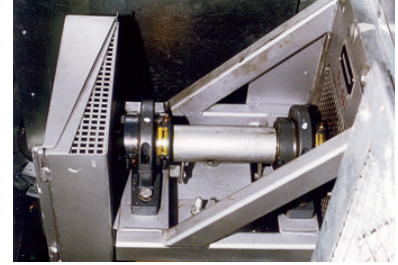

### FANS

A split to the shaft bearing proving the immense savings in downtimes in the paint shop of a UK car plant.

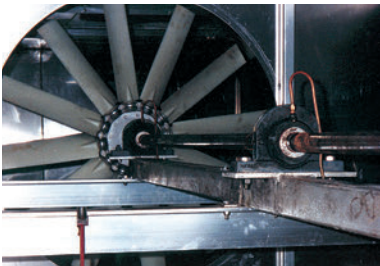

### FANS

The split to the shaft solution eliminates the need to dismount associated components. Combined with the frictionless expansion accommodated by the EX bearing, the split solution is ideal on long drive shafts or hot gas fans.



### SCREW CONVEYOR

Solving the problems of shaft wear and product contamination from oil and rust from the use of sleeve bearings. A custom-built solution combined a triple boss hanger mounting with split roller bearing equipped with double sealing and air purge provision on each end.



### SCREW CONVEYOR

Cleanliness requirements during the final stage of transport of white sugar to the bagging area advocated the use of a custom-built 100mm stainless steel hanger unit.



### BUCKET ELEVATOR

The Cooper flange unit at a grain plant illustrates the advantages of split to the shaft solutions as regards performing maintenance tasks in cramped and inaccessible locations



### BUCKET ELEVATOR

Bucket elevator with Cooper 01 BCP 160mm GR in trapped position for easier, cost-saving maintenance



### BALL MILLS

Cement plant with a Cooper 03BCP 320mm unit on this ball mill. An arduous application due to the dusty environment, Cooper sealing advantages are highlighted.

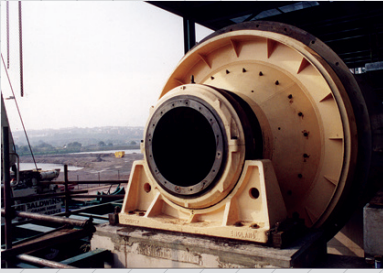

### BALL MILLS

01 BCP 1016mm EXILOG GR fitted to a 10 feet diameter Silica Mill. Split rolling element bearings save considerable power versus sleeve bearings.



### WATER TURBINE

01 BCF 380mm EX was selected in conjunction with the OEM on this 11,000kW vertical shaft 'Kaplan' turbine. Cooper chosen for simplified installation, and uncomplicated inspection and maintenance



### WIND ENERGY

Split rolling element bearings offer significant advantages in handling weights over the non-split version. Shaft tolerance and energy consumption advantages over hydrodynamic sleeve bearings.



### MARINE PROPULSION

The ideal alternative to sleeve bearings for propeller shafts and water jets, split to the shaft bearings eliminate complex oil-feed systems.



### PILGER MILLS

The Cooper brand has long been synonymous with longer bearing life in this most demanding of applications.



### LINK SPINDLES

Cooper double row 780mm bore split taper roller bearing on a link-spindle for a steel making plant.

## CONTACT US

### UK, Europe, South America, Asia, Middle East, India

Cooper Roller Bearings Company Ltd.  
Wisbech Road | Kings Lynn | Norfolk | PE30 5JX | United Kingdom  
Tel: +44 (0) 1553 763447 | Fax: +44 (0) 1553 761113  
Email: [CoopersalesUK@kaydon.com](mailto:CoopersalesUK@kaydon.com)

### Germany

Cooper Geteilte Rollenlager GmbH.  
Postfach 100 423 | Oberbenrader Str. 407 | 47704 Krefeld | Germany  
Tel: +49 (0) 2151 713 016 | Fax: +49 (0) 2151 713 010  
Email: [CoopersalesDE@kaydon.com](mailto:CoopersalesDE@kaydon.com)

### USA, Canada, Mexico and Central America

The Cooper Split Roller Bearing Corp.  
5365 Robin Hood Road | Suite B | Norfolk | VA 23513 | USA  
Tel: +1 (1) 757 460 0925 | Fax: +1 (1) 757 464 3067  
Email: [CoopersalesUS@kaydon.com](mailto:CoopersalesUS@kaydon.com)

### Australia

Cooper Bearings Group  
PO BOX 241 | Kelmscott | Western Australia | 6991  
Tel: +61(0) 8929 108 21 | Fax: +61(0) 8 93979990  
Email: [CoopersalesAU@kaydon.com](mailto:CoopersalesAU@kaydon.com)

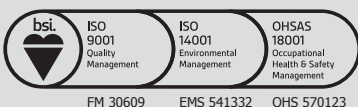

an SKF Group brand



Visit [CooperBearings.com](http://CooperBearings.com)